

ELECTRONIC MEASURING INSTRUMENTS

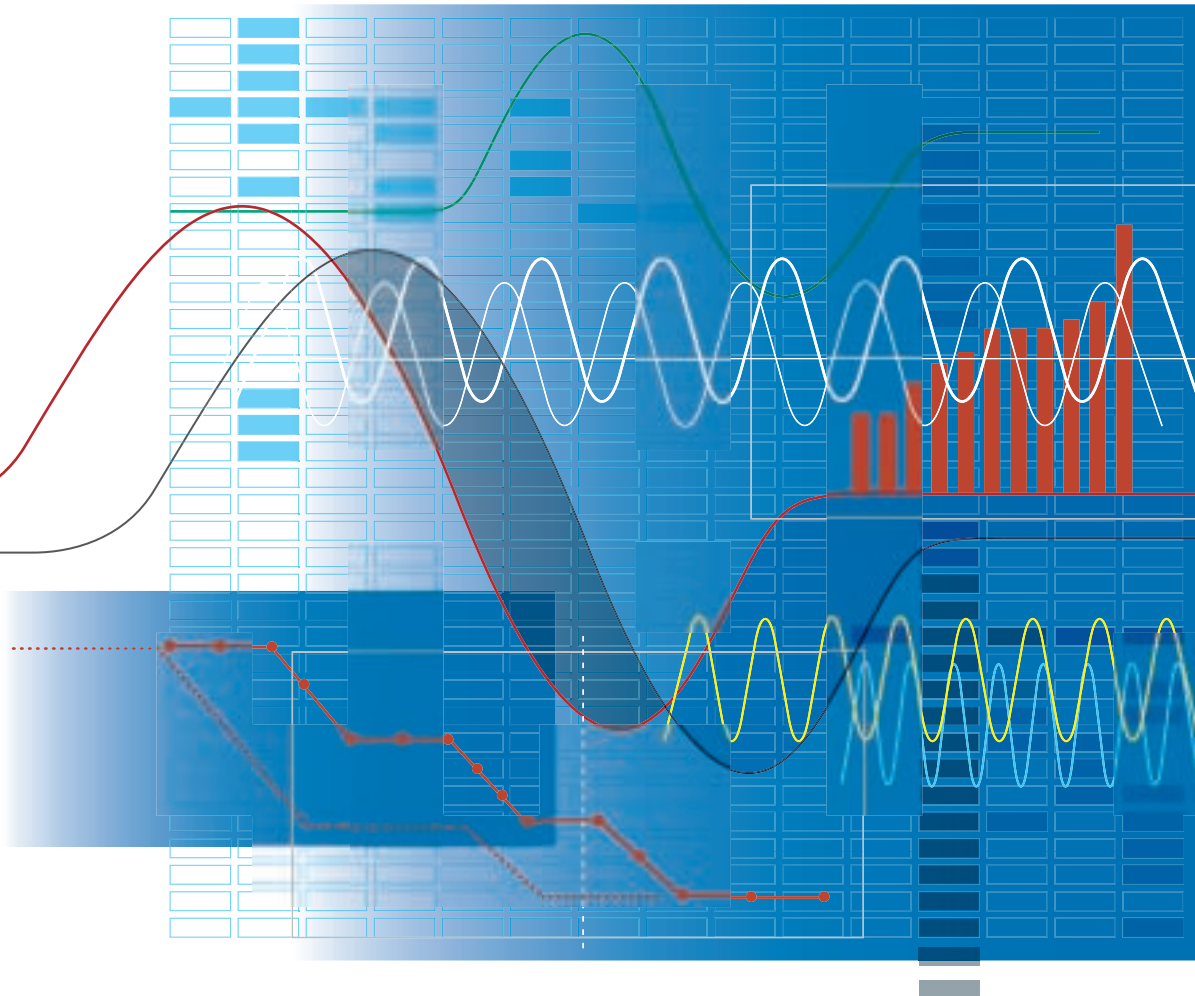

Архангельск (8182)63-90-72
Астана (7172)727-132
Астрахань (8512)99-46-04
Барнаул (3852)73-04-60
Белгород (4722)40-23-64
Брянск (4832)59-03-52
Владивосток (423)249-28-31
Волгоград (844)278-03-48
Вологда (8172)26-41-59
Воронеж (473)204-51-73
Екатеринбург (343)384-55-89
Иваново (4932)77-34-06

Ижевск (3412)26-03-58
Иркутск (395)279-98-46
Казань (843)206-01-48
Калининград (4012)72-03-81
Калуга (4842)92-23-67
Кемерово (3842)65-04-62
Киров (8332)68-02-04
Краснодар (861)203-40-90
Красноярск (391)204-63-61
Курск (4712)77-13-04
Липецк (4742)52-20-81

Магнитогорск (3519)55-03-13
Москва (495)268-04-70
Мурманск (8152)59-64-93
Набережные Челны (8552)20-53-41
Нижний Новгород (831)429-08-12
Новокузнецк (3843)20-46-81
Новосибирск (383)227-86-73
Омск (3812)21-46-40
Орел (4862)44-53-42
Оренбург (3532)37-68-04
Пенза (8412)22-31-16

Пермь (342)205-81-47
Ростов-на-Дону (863)308-18-15
Рязань (4912)46-61-64
Самара (846)206-03-16
Санкт-Петербург (812)309-46-40
Саратов (845)249-38-78
Севастополь (8692)22-31-93
Симферополь (3652)67-13-56
Смоленск (4812)29-41-54
Сочи (862)225-72-31
Ставрополь (8652)20-65-13

Сургут (3462)77-98-35
Тверь (4822)63-31-35
Томск (3822)98-41-53
Тула (4872)74-02-29
Тюмень (3452)66-21-18
Ульяновск (8422)24-23-59
Уфа (347)229-48-12
Хабаровск (4212)92-98-04
Челябинск (351)202-03-61
Череповец (8202)49-02-64
Ярославль (4852)69-52-93

Киргизия (996)312-96-26-47

Россия (495)268-04-70

Казахстан (772)734-952-31



1 Optical Measuring Instruments

37

• Tunable Laser Source • Optical Component Tester • SLD Light Source • Stabilized Light Source • Optical Power Meters • Multi Channel Box • Optical Loss Test Set • Optical Time Domain Reflectometers • Optical Spectrum Analyzer • WDM Network Tester • Optical Amplifier Test System • Optical Channel Selector • E/O, O/E Converter • Optical Directional Coupler • Others



2 Digital Link Measuring Instruments

129

• Pulse Pattern Generators • Error Detectors • 10 GHz Jitter Analyzer • Digital Data Analyzers • SONET/SDH/PDH/ATM Analyzers • Portable 2.5G/10G Analyzer • Data Quality Analyzer • ATM Quality Analyzer • PCM Channel Analyzer • Digital Transmission Analyzer • STM/SONET Analyzer • PCM Codec Analyzer



3 Data Communications Measuring Instruments

195

• Network Data Analyzer • Data Transmission Analyzer



4 Digital Mobile Communications Measuring Instruments

205

• Digital Mobile Radio Transmitter Testers • Digital Modulation Signal Generators • Signalling Testers • Radio Communication Analyzers • W-CDMA Area Tester • Radio Communication Test System • Measuring Receiver • Error Rate Tester



5 HandHeld Measuring Instruments

291

• HandHeld Spectrum Analyzer • Cable Mate • Site Master



6 Spectrum Analyzers

303

• Spectrum Analyzers • Pre-Amplifier



7 Network Analyzers

349

• Vector Network Measurement System • Power Amplifier Test System (PATS) • Vector Network Analyzers • Vector Network Analyzer Automatic Calibrator • Network Analyzers • Scalar Network Analyzer • Reflection Bridges • Transformers



8 Electronic Counters, Power Meters, Voltmeter

387

• Microwave Frequency Counters • Power Meters • Voltmeter



9 Signal Generators

399

• Synthesized Sweep/Signal Generators • Synthesized Signal Generators • Level Generators



10 Radio Communications, EMI Measuring Test Instruments

431

• Measuring Receiver • Radio Communication Analyzer • Frequency Converter • Interference/Field Strength Meters • Antennas • EMI Measuring Systems • EMI Probe • Optional Accessories



11 Analog Transmission Characteristics Measuring Instruments

441

• Calibration Receiver • Level Meter • Transmission Measuring Set • Selective Level Meter • Resistance Attenuator



12 Microwave Measuring Instruments

449

• Radar Test System • Microwave Repeater Checker • Signal Generator • Programmable Attenuators



13 Microwave Components

453

• Connectors • Cables, Adapters • Terminations • Attenuators • SWR Bridges • SWR Autotesters • Airlines • Open/Shorts, Detectors • Power Dividers/Splitters • Bias Tees • DC Blocks • Power Sensors • Test Fixtures • Limiters • Matching Pads • Connector Tools



14 Broadband Test Equipment

519

• DATSPLUS® • eDATS® • BTS® • MATSPLUS® • SMATSPLUS® • Tapestry® OSS



15 Peripheral Equipment & Parts

525

• Pads • Impedance Transformer • Directional Couplers • Branch • High-Pass Filter • Fixed Attenuator for High Power Measurement • Portable Test Rack • RF Amplifier • High Speed Driver • Bessel Filter • Phase Shifter • Bias Tee • Coaxial Cords, Adapters • Dimensions of Waveguide Flanges • Accessories for F-Series Cabinets • Accessories for E-Series Cabinets

Anritsu Corporation's predecessor, Anritsu Electric Co., Ltd., was created by the merger in 1931 of Sekisansha Co., which was founded in 1895 as a manufacturer of wire communication equipment, and Annaka Denki Seisakusho, which was established in 1900 as a pioneer in wireless communication equipment. The company name was changed to Anritsu Corporation in 1985, reflecting the firm's status as an international enterprise and major player in advanced technology. Anritsu continues to draw on its long history and experience in wire and wireless communication equipment, and is a leading manufacturer of a wide variety of advanced products, including communication equipment, instrumentation and control equipment, information terminals, and manufacturing equipment. In particular, Anritsu is acknowledged as the world leader in measurement systems for optical/super high-speed digital communications.

Anritsu products are used in a diverse range of industrial areas by customers in more than 100 countries worldwide. Since July 2000, Anritsu has been strengthening its corporate management through

structural reform to adapt flexibly and responsively as a global corporation to the changing management environment in the 21st century. One measure is the introduction of an internal company system that reorganizes the traditional groups into four independent companies each with clear management responsibility in order to provide cutting-edge and optimum solutions accurately reflecting customer requirements.

To ensure that Anritsu products are of the highest quality, the Anritsu Group is establishing a quality system conforming to international standards, and has become registered as an ISO9001 quality assurance corporation by JQA.

Meanwhile, Anritsu's Atsugi Factory and Tohoku Anritsu Corporation have earned ISO14001 environmental management certification, demonstrating our dedication to preserving the natural environment. In order to continue to be our customer's best partner, we will intensify our efforts to evolve in step with the constantly changing Internet Society.

Head Office



ANRITSU COMPANY Factory



Atsugi Factory



Product support literature

Model	Technical note	Application note	Product introduction	Remarks
37000		√		
3658 AUTOCAL		√		
37100C/37200C/37300C		√		
68C/69B		√		
MD6420A		√	√	
MD6430A		√	√	
MD8480A			√	
ME3401A		√	√	
ME7220A			√	
ME7808A			√	
ME7812 series			√	
ME7840A		√		
ME7894A/MG9541A			√	
MG3633A	√	√	√	
MG3660A/3670B/3671A		√		For GSM/DCS1800
MG3670B			√	
MG3670C/3671B			√	
MG3670C/3671B/0310A		√	√	
MG3672A			√	
MG3681A			√	
MG3690A			√	
MG9001A	√		√	
MG9002A	√		√	
ML8720B			√	
ML9001A	√		√	
ML9002A			√	
ML910B			√	
MN9625A/9626A		√		
MP1220A			√	
MP1560A		√	√	
MP1570A		√	√	
MP1570A1			√	
MP1580A		√	√	
MP1630B		√	√	
MP1632A			√	
MP1630B/1632A		√		
MP1763C/1764C	√	√		
MP1763C/1764C/1777A			√	
MP1776A			√	
MP1777A		√		
MS2650/2660 series		√		For application software
MS2711B			√	
MS371A	√		√	
MS4622 A/B/C		√		
MS4623 A/B/C		√		
MS8604A	√	√	√	
MS8604A	√			Definition of modulation accuracy
MS8604A, MG3670B		√		For DECT
MS8604A, MG3670B		√		For GSM/PCN
MS8608A			√	
MS8609A	√			
MS9720A			√	
MT8801C			√	
MT9810A			√	
MT9810A, MN9662A9664A/9672A/9674A		√		
MW9060A			√	
MW9076 series			√	
MX262001A			√	
S113C/S114C		√		
S251C			√	
S331C/S332C		√		
S820A				

Order by model number

When ordering, please specify the model number and name of the instrument desired, for example, "MP1570A SONET/SDH/PDH/ATM Analyzer." To prevent misunderstandings, include all necessary specifications and specific instructions in your order. That is to say, include all special options or features such as special color, nonstandard power line voltage, etc. To expedite your order we suggest that you contact us directly.

Shipment

Generally, instruments will be shipped within two months of receipt of your order. In the case of "Custom-made products" mentioned in the footnotes, shipment may take from 4 to 7 months. Every endeavor will be made to maintain delivery dates, but no liability is accepted for loss, damage, or delay of instruments, for reasons which are out of our control.

Terms

Unless previous terms have been arranged, we will use one of the following:

- Full payment in advance of shipment
- Sight draft against an irrevocable confirmed letter of credit

Quotations and pro forma invoices

FOB, CIF, C&F, etc., quotations and pro forma invoices are available on request. The instrument price includes packing a charge.

Inspection surcharge

An inspection surcharge is applied to all orders requiring inspection by government agencies or individually appointed inspectors at our factory.

Special products made-to-order

Requests for remodeling standard products for special use will be accepted, but only after detailed discussions.

Replacing parts

To ensure you get the right replacement part in the shortest possible time, please indicate:

- The name, model number, and serial number of the instrument for which the part is sought.
- The name and number of the part as listed in the parts list in the instruction manual.

Returning instrument for repairs

When returning the instrument to Anritsu for repairs, the following suggestions will help us return it to you in the shortest possible time:

- Send complete instructions about what you would like done to the instrument.
- If possible, include the "symptoms" or "defects".
- Indicate the return address, and, if different, the address to be used for billing purposes.

All repairs and recalibrations are carried out at our factory.

Extension service

The normal warranty term is one year, but may be extended to three or five years as an option when purchasing equipment. For three or five years extension service, please ask your local Anritsu Field Office or Sales Representative for price and availability.

Duroid is a registered trademark of Bunker Ramo Corporation.
MS-DOS is a registered trademark of Microsoft Corporation.
Windows is a registered trademark of Microsoft Corporation.
IBM is a registered trademark of International Business Machines Corporation.
i386/i486 are registered trademarks of Intel Corporation.
APC-3.5 is a registered trademark of Amphenol North America, a division of Bunker Ramo Corporation.
K Connector and V Connector are registered trademarks of Wiltron company.
LabWindows and LabVIEW are registered trademarks of National Instruments.
LRL/LRM-Calibration method of Rhode & Schwartz, Germany
Bluetooth and the Bluetooth logos are trademarks owned by the Bluetooth SIG, Inc., U.S.A. and licensed to the Anritsu Corporation.

WARRANTY

All other express warranties are disclaimed and all implied warranties for this product including the warranties of merchantability and fitness for a particular purpose are limited in duration to a period of one year from the date of delivery. In no event shall all Anritsu group be liable to the customer for any damages, including lost profits, or other incidental or consequential damages arising out of the use or inability to use this product.

Repair/calibration

Extended service life of these products ended in December 2000.
Calibration is available.

√: Available, X: Not available, —: Not applicable

Model	Name	Repairs	Calibrations
560	Scalar Network analyzer	X	√
560-6N50	SWR Autotester	X	√
560-6N75	SWR Autotester	X	√
560-6NF50	SWR Autotester	X	√
560-6NF75	SWR Autotester	X	√
560A	Scalar Network analyzer	X	√
610C/D	Sweep Generator	X	√
6100C/D	RF Plug-in	X	√
6200C/D	RF Plug-in	X	√
6237[]	RF Plug-in	X	√
6247[]	RF Plug-in	X	√
640	RF Analyzer	X	√
640E	RF analyzer	X	√
640G50	RF Plug-in	X	√
640G75	RF Plug-in	X	√
640T/R/E	RF Analyzer	X	√
6400-6N50	SWR Autotester	X	√
6400-6 series	SWR Autotester	X	√
6407	RF Analyzer	X	√
6409	RF Analyzer	X	√
DPR7713B	Printer	X	—
M-262[]	Field Strength Meter	X	√
M-321[]	Field Strength Meter	X	√
MA61A	Probe	X	—
MA911A	Optical Sensor	X	√
MA912A	Optical Sensor	X	√
MA912B	Optical Sensor	X	√
MA913[]	Optical Sensor	X	√
MA9304A	Optical Power Sensor (for Optical Power Meter)	X	√
MA9308A	Optical Power Sensor (for Optical Power Meter)	X	√
MA95A	Optical Power Sensor (for Optical Power Meter)	X	√
MA9501A	Optical Power Sensor (for Optical Power Meter)	X	√
MA96A/E/F	Optical Power Sensor (for Optical Power Meter)	X	√
MA97A/B	Optical Power Sensor (for Optical Power Meter)	X	√
MA98B	Optical Power Sensor (for Optical Power Meter)	X	√
MC3601A	Monochrome Display	X	—
MC3602A	Color Display	X	—
MD1401B	LAN Analyzer	X	√
ME314A	Error Rate Measuring Equipment	X	√
ME320A	Error Rate Measuring Equipment	X	√
ME434[]	Microwave System Analyzer	X	√
ME462B	DS-3 Transmission Analyzer	X	√
ME520A/C	Digital Transmission Analyzer	X	√
ME525[]	Microwave System Analyzer	X	√
ME642A	Calibration Receiver	X	√
ME643A	Error Rate Measuring Equipment	X	√
ME9301A	Chromatic Dispersion Measuring Set	X	√
ME96A/B/C	Optical Fiber Transmission Measuring Set	X	√
ME98[]	Optical fiber Transmission Measurement Equipment	X	√
MF55[]	Frequency Counter	X	√
MF56[]	Frequency Counter	X	√
MF62[]	Frequency Counter	X	√
MF63A	Frequency Counter	X	√
MF64A	Frequency Counter	X	√
MF74A	Microwave Frequency Counter	X	√

Model	Name	Repairs	Calibrations
MG22A	Digital Signal Generator	X	√
MG311B	Video signal Generator	X	√
MG439A/B	Standard Signal Generator	X	√
MG440[]	Synthesizer	X	√
MG445A/B	Noise Generator	X	√
MG523A/B	Standard Signal Generator	X	√
MG524A/B	Standard Signal Generator	X	√
MG528A	Standard Signal Generator	X	√
MG54C/D/E	Signal Generator	X	√
MG545[]	Synthesizer	X	√
MG547[]	Signal Generator	X	√
MG642A	Pulse Pattern Generator	X	√
MG645A	Standard Signal Generator	X	√
MG649A	Synthesized Signal Generator	X	√
MG655A	Synthesized Signal Generator	X	√
MG911A	Stabilized Light Source Unit	X	√
MG912B	Stabilized Light Source Unit	X	√
MG92A/B	Stabilized Light Source Unit	X	√
MG921A	Stabilized Light Source	X	√
MG923A	Stabilized Light Source	X	√
MG925A	Stabilized Light Source	X	√
MG927A	Handy Visible Light Source	X	√
MG93B	Stabilized Light Source	X	√
MG9301A	Optical Signal Generator	X	√
MG932A	Stabilized Light Source	X	√
MG94B	Stabilized Light Source	X	√
MG96A/B	Stabilized Light Source	X	√
MG9603A	Heterodyne Optical Sweeper	X	√
MG9605A	Heterodyne Optical Sweeper	X	√
MG9632A	Tunable Light Source	X	√
MG97[]	Stabilized Light Source	X	√
MG9801A	Optical Signal Generator	X	√
MG99A	Visible Light Source	X	√
MH628A	Tracking Generator	X	√
MH672A	Tracking Generator	X	√
MH673A	Adjacent Channel Power Meter	X	√
MH681J	S-Parameter Test Set	X	√
MH922A	E/O Unit	X	√
MH923A	E/O Unit	X	√
MH945A	E/O Converter	X	√
MH946A	O/E Converter	X	√
MH95A	E/O Unit	X	√
MH951A	Plug-in Unit (for OTDR)	X	√
MH952A	Plug-in Unit (for OTDR)	X	√
MH955A	Plug-in Unit (for OTDR)	X	√
MH958A	Plug-in Unit (for OTDR)	X	√
MH968A	Plug-in Unit (for OTDR)	X	√
ML428A	Interference/Field Strength Meter	X	√
ML48[]	Digital Level Meter	X	√
ML512A	Field Strength Meter	X	√
ML520A/B	Selective Level Meter	X	√
ML56A/B/C	Field Strength Meter	X	√
ML57A/B	Field Strength Meter	X	√
ML58A/B	Level Meter	X	√
ML612A/B	Selective Level Meter	X	√
ML64A	Field Strength Meter	X	√
ML94A	Optical Power Meter	X	√
ML96A	Optical Handy Power Meter	X	√
MN61A/B	Resistance Attenuator	X	√
MN925A	Optical Attenuator	X	√
MN936A	Optical Channel Selector	X	√

Continued on next page

√: Available, X: Not available, —: Not applicable

Model	Name	Repairs	Calibrations
MN937A	Optical Channel Selector	X	√
MN939B/C	Programmable Optical attenuator	X	√
MN95A/B	Optical Variable Attenuator	X	√
MN9501A	Optical Channel Selector	X	√
MP1501A	Error Rate Measuring Equipment	X	√
MP1601A	Pulse Pattern Generator	X	√
MP1602A	Error Detector	X	√
MP1604A/B	Pulse Pattern Generator	X	√
MP1605A/B	Error Detector	X	√
MP1608A	Pulse Pattern Generator	X	√
MP1609A	Error Rate Detector	X	√
MP5201A	ISDN Basic Interface Tester	X	√
MP95A	Waveform Monitor	X	√
MP9502A	E/O Converter	X	√
MP9503A	E/O Converter	X	√
MP9504A	E/O Converter	X	√
MP96A	Waveform Monitor	X	√
MR21A	Return Loss Measuring Set	X	√
MR31A	Return Loss Measuring Set	X	√
MR91A	Optical Return Loss Measuring Set	X	√
MR92A	Optical Return Loss Measuring Set	X	√
MR93A	Optical Return Loss Measuring Set	X	√
MS08A/B/C	Data Communication Analyzer	X	√
MS088A	Data Communication Analyzer	X	√
MS09[]	Voice Band Monitor	X	√
MS210A	FFT Digital Scope	X	√
MS2601A/J	Spectrum analyzer	X	√
MS322A/B	DG and DP Measuring Set	X	√
MS334A	PCM Code Error Detector	X	√
MS337A	PCM Code Error Detector	X	√
MS348A	PCM CODEC Tester	X	√
MS349D/E	Video Signal Analyzer	X	√
MS354[]	Terminal Equipment Analyzer	X	√
MS380B	LAN Analyzer	X	√
MS381[]	Multi Media Transmission Analyzer	X	√
MS382A	Multi Media Line Monitor	X	√
MS420[]	Network/Spectrum Analyzer	X	√
MS430A	FFT Digital Scope	X	√
MS52B	Output Tester	X	√
MS521[]	Error Generator	X	√
MS550[]	Digital Error Analyzer	X	√
MS560J	Network/Spectrum Analyzer	X	√
MS57A/C	FM Liner Detector	X	√
MS610[]	Spectrum Analyzer	X	√
MS611A	Spectrum Analyzer	X	√
MS612A	Spectrum Analyzer	X	√
MS62[]	Spectrum Analyzer	X	√
MS620J	Network/Spectrum Analyzer	X	√
MS68A/B	Spectrum Analyzer	X	√
MS710A/B	Spectrum Analyzer	X	√
MS9001A/B/B1	Optical Spectrum Analyzer	X	√
MS9002A/C	Optical Spectrum Analyzer	X	√
MS9003[]	Optical Spectrum Analyzer	X	√
MS93A	Optical Tester	X	√
MS94A	Optical Tester	X	√
MS95A	Optical Tester	X	√
MS96A	Optical Spectrum Analyzer	X	√
MS9602A	Laser Linewidth Analyzer	X	√
MS97A	Optical Fiber Tester	X	√
MS98A	Optical Talk Tester	X	√
MS99A	Optical Spectrum Analyzer	X	√
MT2501A	Radio Tester	X	√
MW0935A	Plug-in Unit (for OTDR)	X	√

Model	Name	Repairs	Calibrations
MW0936A	Plug-in Unit (for OTDR)	X	√
MW0937A	Plug-in Unit (for OTDR)	X	√
MW0945A	Plug-in Unit (for OTDR)	X	√
MW0946A	Plug-in Unit (for OTDR)	X	√
MW0958A/B	Plug-in Unit (for OTDR)	X	√
MW0960A/B	Plug-in Unit (for OTDR)	X	√
MW9001B	OTDR	X	√
MW9010B	OTDR	X	√
MW9040B	OTDR	X	√
MW9043A/B	OTDR	X	√
MW920A	OTDR	X	√
MW98A	OTDR	X	√
MZ100A	E/O Converter	X	√
MZ118A	O/E Converter	X	√
UA455A	Video Plotter	X	—
UA855A	Video Plotter	X	—

10 GHz Jitter Analyzer	138
10G (131) Module (for MD1230A).....	176
10G (155) Module (for MD1230A).....	176
10M/100M Ethernet Module (for MD1230A)	181
125 Gb/s Error Detector Unit (for MP1776A)	132
1.5/45/52/52M (131) Unit (for MP1570A/A1)	166
1.5/45/52M Unit (for MP1570A/A1)	166
1.5/45/52M, 156/622M Jitter Unit (for MP1570A/A1).....	166
15 dB ENR Noise Source (3.5 mm)	355
2.5G (131) Module (for MD1230A).....	176
2.5G (131) Unit (for MP1570A/A1)	170
2.5G (131/155) Unit (for MP1570A/A1)	166
2.5G (155) Module (for MD1230A).....	176
2.5G (155) Unit (for MP1570A/A1)	166
2.5G Jitter Unit (for MP1570A/A1).....	161
2.5G/10G Jitter Unit (for MP1580A)	168
2.5G/10G Unit (for MP1570A/A1).....	165
2/8/34/139M, 15/45/52M, 156/622M Jitter Unit (for MP1570A/A1).....	166
2/8/34/139M, 156/622M Jitter Unit (for MP1570A/A1)	166
200M 16CH Error Detector Unit (for MP1630B).....	145
200M 16CH Pulse Pattern Generator Unit (for MP1630B).....	145
200M Clock Generator Unit (for MP1630B)	145
3.2G Error Detector (for MP1632C)	147
3.2G Pulse Pattern Generator (for MP1632C)	147
5 dB ENR Noise Source (35 mm)	355
50 Ω ↔ 75 Ω Impedance Transformer	526
6.3/25M Unit (for MP1220A).....	185
6.3M Unit (for MP1220A).....	185
π/4 DQPSK Analysis Software (for MS8604A).....	221
π/4 DQPSK Modulation Unit (for MG3670B/C, MG3671A/B, MG3672A, MG3660A)	237, 241
A	
Absorption Clamp (for EMI).....	432
AC Power Pack (for ML524B).....	434
Adapter (for ML9001A/9002A).....	54, 59
Add/Drop Unit (for MP1570A/A1)	164
Air Lines	493
AMPS/PCS1900 Measurement Software (for MT8801C).....	275
Analog Unit (for MD6420A)	204
ATM 25M Unit (for MP1220A)	185
ATM Quality Analyzer	182
ATM Unit (for MP1570A/A1)	163
AutoCal® (Automatic Calibration)	350, 351, 354, 359
Autotesters	488, 490, 491
AWGN Unit (for MG3681A)	236
B	
Bare Fiber Connector	124
Battery Charger (for ML524B)	434
Battery Pack (for ML524B)	434
Bessel Filter	531
Bias Tees	507, 508, 510, 533
Bluetooth™ Test Set	259
Branch	527
Broadband Vector Network Analyzer	368
BTS®	521
Burst Function Unit (for MG3670B/C, MG3671A/B, MG3672A, MG3660A)	237
C	
Cable Mate	292
Calibration Grade Adapters	472
Calibration Kits	372
Calibration Receiver	442
CATV Measurement Software (for MS2650, MS2660 series)	331, 338, 346
CDMA Cellular System Measurement Software (for MS2650/2660 series).....	331, 338, 346
CDMA Modulation Unit (for MG3670C/3671B/3672A)	237
CDMA Modulation Unit (for MG3681A)	230
Circulator	255, 359
Clock Recovery Unit (for MP9677B).....	118
CM Directional Coupler	527
CMI Unit (for MP1570A/A1).....	164
Coaxial Adapters	470
Coaxial Cords	534
Coaxial Switch (for ME7812 series)	281, 283
Coaxial Terminations	481
CODEC Unit (for MD6420A).....	204
Connector Adapter (for ML9001A)	59
Connector Adapter (for ML9002A, MS9020D)	62, 76
Connector Adapter (for MT9810A/9812B).....	71
Connector Tools	466
Connectors	456, 461, 465
Convertible SWR Autotesters	491
CPU (for MD8480A)	251
CT2 Application Software (for MS8604A)	229
Current Probe	359
D	
Data Transmission Analyzer	200
Datacom Interface Unit (for MD6430A)	199
Data Quality Analyzer	176
Data Quality Analyzer Control Software (for MD1230A)	181
DATS^{PLUS}®	521
DC Blocks	512, 514
DECT Application Software (for MS8604A)	229
DECT Measurement Software (for MT8801C)	275
Detectors	496, 499
Digital Data Analyzer	141, 146
Digital MCA Analysis Software (for MS8604A)	229
Digital Mobile Radio Transmitter Tester	207, 213, 220
Digital Modulation Signal Generator	230, 237, 248
Digital Transmission Analyzer	194
Dipole Antenna	436
Directional Coupler	527
Display Unit (for MW9076 series).....	82
Distortion Measurement Unit (for MD6420A)	204
DS1/DS1C Interface (for MD6420A)	204
E	
E/O, O/E Converter	118
E1/E3 Unit (for MP1220A).....	184
E1/E3/E4 Unit (for MP1220A).....	187
eDATS®	521
Edge Emitting LED Source (for MG9001A/9002A)	56
Electronic Voltmeter	398
EMI Measurement Software (for MS2650/2660 series)	331
EMI Probe	331
EMI Probe Kit	331
Error Analyzer Unit (for MD6420A)	204
Error Detector	131, 136
Error Rate Tester	289
External Mixer (for MS2667C/2668C)	314, 319
F	
Fiber Adapter	124
Fiber Adapter (for ML9001A/9002A)	56, 59
Fiber Jacket Stripper (for optical accessories)	127
Field Replaceable Diode Modules.....	498
File Transfer Utility (for MS8608A).....	219
File Utility Software (for MS2683A)	309
Fixed Attenuator (for ML2530A)	432
Fixed Attenuators	483, 528
Four-Port Junction Pad	526
Frame Coder (for MD8480A).....	253

Frame Decoder (for MD8480A)	253
Frequency Converter	435
Frequency-Response Compensation Software (for MG3633A).....	428
G G703, AMI Interface (for MD6420A).....	204
GFSK Modulation Unit (for MG3670B/C, MG3671A/B, MG3672A, MG3660A).....	236
GIF 085/130 μm Unit (for MW9060A).....	89
Gigabit Ethernet Module (for MD1230A).....	176
GMSK Modulation Unit (for MG3670B/C, MG3671A/B, MG3660A)	236, 241
GPIB Remote Control Unit (for MD6420A).....	201
GSM Application Software (for MS8604A)	229
GSM Device Test Software (for MU368010A).....	236
GSM Measurement Software (for MS2650/2660 series).....	331, 338, 346
GSM Measurement Software (for MS2683A).....	309
GSM Measurement Software (for MS8608A/8609A)	208
GSM Measurement Software (for MT8801C).....	270
H HandHeld Spectrum Analyzer	294
Hi-Cap Test System	523
High Accuracy Sensor (for ML2430 series)	396, 502
High Speed Driver	530
High-Pass Filter	528
I Instrumentation Grade Adapters	473, 474, 477
Integrated V Connectors	465
Interference/Field Strength Meter	435
IS-136A Measurement Software (for MT8801C).....	277
IS-95 Device Test Software (for MU368040A).....	236
ISDN (for MD8480A)	251
J Jitter Unit (for MD6420A).....	201
K KT-10 Absorption Clamp.....	440
L LabVIEW® Driver (GPIB) (for MS9720A)	76
LabVIEW® Driver (RS-232C) (for MS9720A)	76
LD Source (for MS9020D).....	77
LED Source (for MG9001A/9002A).....	58
LED Source (for MS9020D).....	76
Level Correction Software (for ME7812 series).....	281
Level Meter	446
Light Source (for MT9810A/9812B).....	64, 70, 73
Log-Periodic Antenna	436
Loop Antenna	437
Low-Power Data Communication System Measurement Software conforming to issue of Direct Spread Spectrum System (for MS2650/2660 series).....	331, 338, 346
Low-Power Data Communication System Measurement Software conforming to issue of Frequency Hopping System (for MS2650/2660 series).....	331, 338, 346
M Matching Pad and Impedance Adapter	518
MATS^{PLUS}	522
Measuring Receiver	289, 433
Microwave Detectors	496, 499
Microwave Frequency Counter	388
Microwave Repeater Checker	452
Millimeter-Wave Measurement System	379
Millimeter-Wave Modules	368
Millimeter-Wave Vector Network Analyzer	365
Mode Scrambler (for optical accessories)	127
Modulation Analyzer	445
Modulation Unit (for MG9001A/9002A)	58
MP165X to MP1632A/C Pattern Conversion Software (for MP1632C)	146
Multi Channel Box	70
N NADC Measurement Software (for MS8604A).....	229
Network Analyzer	375, 381, 386
Network Analyzer Measurement System	350
Network Analyzer Measurement System/ Direct-Access Receiver	356, 359
Network Data Analyzer	196
Noise Sources	355
NRZ Unit (for MP1570A/A1).....	170
O Offset Terminations	481
Open/Shorts	494
Optical 10G Rx (Narrow) Unit (for MP1570A/A1).....	170
Optical 10G Rx (Wide) Unit (for MP1570A/A1)	170
Optical 10G Tx (131) Unit (for MP1570A/A1).....	170
Optical 10G Tx (155) High Power Unit (for MP1570A/A1)	170
Optical 10G Tx (155) Unit (for MP1570A/A1).....	170
Optical 156M/622M (131) Unit (for MP1570A/A1).....	170
Optical 156M/622M (133/155) Unit (for MP1570A/A1).....	170
Optical 156M/622M (155) Unit (for MP1570A/A1).....	170
Optical 2.5G/10G Rx (Wide) Unit (for MP1570A/A1)	170
Optical 2.5G/10G Tx (1.31) Unit (for MP1570A/A1).....	170
Optical 2.5G/10G Tx (1.55) High Power Unit (for MP1570A/A1).....	170
Optical Amplifier Test System	109
Optical Attenuator	124
Optical Attenuator (for ML9001A).....	59
Optical Channel Drop Unit (OCDU)	121
Optical Channel Selector	114
Optical Channel Selector Unit (for MW9076 series)	83
Optical Component Tester	48
Optical Component Tester Control Software (FD) (for ME7894A)	49
Optical Directional Coupler	120
Optical Handy Power Meter	61
Optical Loss Test set	73
Optical Modulator	112
Optical Power Meter	57, 122
Optical Power Sensor (for ML9001A/9002A, MS9020D)	57, 61, 74
Optical Sensor (for ME7894A).....	49
Optical Sensor (for ML9001A).....	57
Optical Sensor (for MT9810A/9812B)	59, 57
Optical Sensor Holder (for ML9001A)	59
Optical Spectrum Analyzer	90, 95, 103
Optical Test Set	64
Optical Test Set (for ME7894A).....	49
Optical Time Domain Reflectometer	78, 85
Optical Variable Attenuator	123
Optical Wavelength/Frequency Counter	122
OTDR Emulation Software (for MW9076 series)	80, 84
P PCM Channel Analyzer	188
PCM CODEC Analyzer	194
PDC Measurement Software (for base station) (for MS2650/2660 series).....	331, 338, 346
PDC Measurement Software (for MS8604A)	229
PDC Measurement Software (for MT8801C)	270

PDC Measurement Software with Call Processing (for MT8801C)	270
PDC Software (for MU368010A)	236
Phase Shifter	532
PHS Measurement Software (for MS8604A)	229
PHS Measurement Software (for MT8801C)	270
PHS Measurement Software with Call Processing (for MT8801C)	270
PHS Software (for ME7812 series)	285
Portable 2.5G/10G Analyzer	172
Portable Test Rack	528
Power Amplifier Test System (PATS)	358
Power Dividers	503, 504
Power Meter	391
Power Sensor (for ML2430 series)	396, 502
Power Sensor (for ML2530A series)	444
Power Splitters	505, 506
Pre-amplifier	347
Pre-amplifier (for MA8611A)	440
Precision DC Blocks	512
Preselector	435
Probe (for ML69B)	398
Programmable Attenuator	452
Programmable Optical Attenuator	116
Protocol Decoding Software (for MP1220A)	186
Protocol Unit (for MP1220A)	186
Pulse Modulator (for MG3633A)	428
Pulse Pattern Generator	130, 133
Q Q and Eye Analysis Software (for MP1632C)	133
Q and Eye Analysis Software (for MP1763C/1764C)	136
Q and Eye Analysis Software	146
QoS Unit (for MP1220A)	186
QPSK Modulation Unit (for MG3670C/3671B/3672A)	237
R Radar Test Set (RTS)	450
Radio Communication Analyzer	265, 269, 435
Radio Communication Test System	281
Range Calibrator (for ML2430A)	397
Reference Source (for ML2430A)	397
Reflection Bridge	386
Resistance Attenuator	447
Return Loss Unit (for MS9020D)	74
RF Amplifier	529
RF Cables	467
RF Limiters	517
RFTS®	125
Rod Antenna	437
RS-232C Remote Control Unit (for MD6420A)	204
Ruggedized Adapters	473
Rx Baseband (for MD8480A)	253
S Scalar Network Analyzer	386
SDH/SONET Pattern Editor (for MP1632C)	146
SDH/SONET Pattern Editor (for MP1763C/1764C)	133, 136
Selective Level Meter	446
Sensor Adapter (for ME7894A)	51
Sensor Adapter (for ML9002A)	61
Sensor Adapter (for MT9810A/9812B)	68
Sensor Holder (for ML9002A)	59
Sensor Module (for ML2530A)	444
Signal Generator	452
Signalling Tester	254, 256
Site Master	297
SLD Light Source	52
SMAS Test Access Concentrator (STAC)	523
SMATS^{PLUS}®	522
SMF 1.31 μm Unit (for MW9060A)	89
SMF 1.31/1.55 μm Unit (for MW9060A)	89
Software for Pattern Generator Data Write (for MG3641A3642A)	423
SONET/SDH/PDH/ATM Analyzer	150, 169
Spectrum Analyzer	305, 310, 315, 321, 326, 332, 339
Stabilized Light Source	54
Standard Optical Power Meter	122
Step Attenuators	485
STM/SONET Analyzer	194
STM-1/OC-3 Unit (for MP1220A)	183
STM-4/OC-12 Unit (for MP1220A)	183
Switch Unit for Transceiver Continuous Test (for ME7812 series)	281
SWR Autotesters	488, 490, 491
SWR Bridge	487
Synthesized CW Generator	400
Synthesized Level Generator	429
Synthesized Signal Generator	419, 424
Synthesized Sweep Signal Generator	409
Synthesizer/Level Generator	429
T T1/T3 Unit (for MP1220A)	184
Tapestry, Fault Management OSS	522
TDMA Modulation Unit (for MG3681A)	236
Test Port Heads	491
TEXT to MP1632A/C Pattern Conversion Software (for MP1632C)	146
Thermal Power Sensor (for ML2430 series)	396, 502
Timing Generator (for MD8480A)	253
Torque Wrench	466
T-Pad	526
Transformer (for Network Analyzer)	386
Transmission Measuring Set	446
Transmission/Reflection Module	367
TTL Interface Unit (for MD6420A)	203
Tunable Laser Source	45
Tx Baseband (for MD8480A)	253
U U-Link	534
Ultra Low Noise Synthesized CW Generator	410
Ultra Low Noise Synthesized Signal Generator	410
Ultra Low Noise Synthesized Sweep Generator	410
Ultra Low Noise Synthesized Sweep/Signal Generator	410
Ultra-Wideband Bias Tee	510
Universal Test Fixtures	516
V V/X series Interface (for MD6420A)	201
Vector Network Analyzer	360, 365
Vector Network Analyzer Automatic Calibrator	370
Vector Network Analyzer/Direct-Access Receiver Configuration	365
Vector Network Measurement System	350
Vector Network Measurement System, Direct-Access Receiver	356
Verification Kits	374
Voice Codec (for MD8480A)	253
W Wander Measurement Application Software (MTIE/TDEV) (for MP1580A)	173
Wander (MTIE, TDEV) Measurement Application Software (for MP1570A/A1)	165
Waveform Monitor	123
Waveguide-to-Coaxial Adapters	474, 477

- W-CDMA Area Tester**278
- W-CDMA Measurement Software (for MS2683A).....309
- W-CDMA Measurement Software (for MS8608A).....213
- W-CDMA Measurement Software (for MS8609A).....207
- W-CDMA Measurement Software (for MT8820A)265
- W-CDMA Signalling Tester**251
- W-CDMA Signalling Tester Ciphering (for MD8480A)252
- W-CDMA Signalling Tester Control software
(for MD8480A)252
- W-CDMA Signalling Tester Firmware (for MD8480A)252
- W-CDMA Signalling Tester FPGA (for MD8480A).....252
- W-CDMA Signalling Tester ISDN/PPP (for MD8480A).....252
- W-CDMA Software (for MG3681A).....231
- W-CDMA Software (for MU368040A).....234
- W-CDMA Virtual Signaling System**286
- WDM Network Tester**100
- WDM Tester**107
- Word Memory Unit (for MD6420A)204



- X/V series Interface (for MD6420A)201

01-201	Connector Torque Wrench.....	466	3740A-F	Transmission/Reflection Module (90 to 140 GHz, WR-8).....	367
01-204	Connector Wrench.....	466	3740AQ	Transmission/Reflection Module (33 to 50 GHz, WR-22).....	367
1 Series	RF Limiters	517	3740A-V	Transmission/Reflection Module (50 to 75 GHz, WR-15).....	367
1000-50	Circulator, 800-1000 MHz, 100 Watts.....	359	3740A-W	Transmission/Reflection Module (75 to 110 GHz, WR-10).....	367
1000-52	Circulator, 1.8-2.5 GHz, 20 dB min. 50 Watts.....	359	3741A-E	Transmission/Reflection Module (60 to 90 GHz, WR-12).....	367
1000-53	Circulator, 1.8-2.5 GHz, 22 dB min. 79 Watts.....	359	3741A-EE	Transmission/Reflection Module (56 to 94 GHz, WR-12).....	367
12 Series	Matching Pad and Impedance Adapter	518	3741A-EW	Transmission/Reflection Module (65 to 110 GHz, WR-10).....	367
18 Series	Air Lines	493	3741A-F	Transmission/Reflection Module (90 to 140 GHz, WR-8).....	367
19 Series	Air Lines	493	3741A-Q	Transmission/Reflection Module (33 to 50 GHz, WR-22).....	367
2000-1067	Current Probe.....	359	3741A-V	Transmission/Reflection Module (50 to 75 GHz, WR-15).....	367
2000-1085	Current Probe.....	359	3741A-W	Transmission/Reflection Module (75 to 110 GHz, WR-10).....	367
22 Series	Open/Shorts	494	3750LF	Calibration Kit, SMA/3.5 mm	373
25 Series	Test Port Heads	491	3751	Calibration Kit, GPC 7, Economy	373
26 Series	Coaxial Terminations	481	3751LF	Calibration Kit, GPC 7, 6 GHz	373
28 Series	Coaxial Terminations	481	3753	Calibration Kit, Type N, Economy	373
29 Series	Offset Terminations	481	3753LF	Calibration Kit, Type N, 6 GHz	373
33 Series	Coaxial Adapters	472	41 Series	Fixed Attenuators	483
34 Series	Coaxial Adapters	473	43 Series	Fixed Attenuators	483
34R Series	Ruggedized Adapters	473	4400 Series	Step Attenuators	485
34V Series	Coaxial Adapters	473	4500 Series	Step Attenuators	485
35 Series	Waveguide-to-Coaxial Adapters	474, 477	4600 Series	Step Attenuators	485
3650, 3650-1	Calibration Kit, SMA/3.5 mm	372	54000 Series	Millimeter Wave Measurement System	379
3651, 3651-1	Calibration Kit, GPC 7	372	5400-6 Series	SWR Autotesters	490
3652, 3652-1	Calibration Kit, K Connector	372	5400-71 Series	Microwave Detectors	499
3653	Calibration Kit, Type N	372	54100A Series	Network Analyzer	375
3654B	Calibration Kit, V Connector	373	560-7 Series	Microwave Detectors	499
3655E, 3655E-1	Calibration Kit, WR-12 Waveguide	367, 373	560-97 Series	SWR Autotesters	488
3655F, 3655F-1	Calibration Kit, WR-8 Waveguide	367, 373	560-98 Series	SWR Autotesters	488
3655Q, 3655Q-1	Calibration Kit, WR-22 Waveguide	367, 373	560-98C50A	Convertible SWR Autotester	491
3655V, 3655V-1	Calibration Kit, WR-15 Waveguide	367, 373	56100A	Scalar Network Analyzer	386
3655W, 3655W-1	Calibration Kit, WR-10 Waveguide	367, 373	68000C	Series Synthesized CW Generator	409
3658 Series	Vector Network Analyzer Automatic Calibrator	370	68100C	Series Synthesized Sweep Generator	409
3663	Verification Kit, Type N	374	68300C	Series Synthesized Sweep Signal Generator	409
3663LF	Verification Kit, Type N, 6 GHz	374	69000B	Series Ultra Low Noise Synthesized CW Generator	409
3665E	Verification Kit, WR-12 Waveguide	374	69100B	Series Ultra Low Noise Synthesized Sweep Generator	409
3665Q	Verification Kit, WR-22 Waveguide	374	69300B Series	Ultra Low Noise Synthesized Sweep/Signal Generator	409
3665V	Verification Kit, WR-15 Waveguide	374	70 Series	Microwave Detectors	496
3665W	Verification Kit, WR-10 Waveguide	374	75 Series	Microwave Detectors	496
3666	Verification Kit, SMA/3.5 mm	374	87 Series	SWR Bridges	487
3666LF	Verification Kit, SMA/3.5 mm, 6 GHz	374	9611	RFTS	125
3667	Verification Kit, GPC-7	374	9620	DATS plus	521
3667LF	Verification Kit, GPC-7, 6 GHz	374	9622	eDATS	521
3668	Verification Kit, K Connector	374	9650	BTS	521
3669B	Verification Kit, V Connector	374	9661	MATS plus	522
3680 Series	Universal Test Fixtures	516	9662	SAMTS plus	522
37000 family	Millimeter Wave Vector Network Analyzer	365	97 Series	Autotesters	488
37100C Series	Vector Network Analyzer/Direct-Access Receiver Configuration	360	9724	STAC	523
37200C Series	Vector Network Analyzer	360	9725	SICU	523
37300C Series	Vector Network Analyzer	360			
3735B	Millimeter Wave Test Set	367			
3740A-E	Transmission/Reflection Module (60 to 90 GHz, WR-12).....	367			
3740A-EE	Transmission/Reflection Module (56 to 94 GHz, WR-12).....	367			
3740A-EW	Transmission/Reflection Module (65 to 110 GHz, WR-10).....	367			

A

A3H1001	RF Amplifier	529
A3H1002	RF Amplifier	529
A3H2030	RF Amplifier	529
A3H2051	RF Amplifier	529
A3H2120	RF Amplifier	529
A3H2121	RF Amplifier	529
A3H2150	RF Amplifier	529
A3H2200	RF Amplifier	529
A3H2206	High Speed Driver	530
A3H4030	RF Amplifier	529
A3H4080	RF Amplifier	529
A3HA2100	RF Amplifier	529
A3HB3102	RF Amplifier	529
A3HC2107	High Speed Driver	530
A3HE2096	High Speed Driver	530
A3N1000	Series Bias Tee	533
A5N1001	Phase Shifter	532
A5N1102	Phase Shifter	532
AF1000 Series	Bessel Filter	531

C

C751	Cable Mate	292
C752	Cable Mate	292

K

K Series	Connectors	456
K120	Series RF Cables	467
K200B	Coaxial Adapters	470
K240	Power Dividers	504
K241 Series	Power Splitters	505
K250	Bias Tees	507
K251	Ultra-Wideband Bias Tees	508
K261	Precision DC Blocks	512
KT-10	Absorption Clamp (for EMI)	440

MA

MA1610A	Pulse Modulator (for MG3633A)	428
MA1612A	Four-Point Junction Pad	526
MA2201A	Reflection Bridge	386
MA2401A	Reflection Bridge	386
MA2418A	Reference Source (for ML2430A)	397
MA2421B	Thermal Power Sensor (for ML2430 series)	396, 502
MA2422B	Thermal Power Sensor (for ML2430 series)	396, 502
MA2423B	Thermal Power Sensor (for ML2430 series)	396, 502
MA2424B	Thermal Power Sensor (for ML2430 series)	396, 502
MA2425B	Thermal Power Sensor (for ML2430 series)	396, 502
MA2442A	High Accuracy Sensor (for ML2430 series)	396, 502
MA2444A	High Accuracy Sensor (for ML2430 series)	396, 502
MA2445A	High Accuracy Sensor (for ML2430 series)	396, 502
MA2450A	Sensor Module (for ML2530A series)	444
MA2469A	Power Sensor (for ML2430 series)	396, 502
MA2472A	Power Sensor (for ML2430 series)	396, 502
MA2473A	Power Sensor (for ML2430 series)	396, 502

MA2474A	Power Sensor (for ML2430 series)	396, 502
MA2475A	Power Sensor (for ML2430 series)	396, 502
MA2499B	Sensor Adapter (for ML2430 series)	396, 502
MA2540A	Sensor Module (for ML2530A)	444
MA2601B/C	EMI Probe	331
MA2740A	External Mixer (for MS2667C/2668C)	314, 320
MA2741A	External Mixer (for MS2667C/2668C)	314, 320
MA2742A	External Mixer (for MS2667C/2668C)	314, 320
MA2743A	External Mixer (for MS2667C/2668C)	314, 320
MA2744A	External Mixer (for MS2667C/2668C)	314, 320
MA2745A	External Mixer (for MS2667C/2668C)	314, 320
MA2746A	External Mixer (for MS2667C/2668C)	314, 320
MA29A/J	Transformer (for Network Analyzer)	386
MA313A/J	Transformer (for Network Analyzer)	386
MA314A/J	Transformer (for Network Analyzer)	386
MA315A/J	Transformer (for Network Analyzer)	386
MA422A1	Transformer (for Network Analyzer)	386
MA61B	Probe (for ML69B)	398
MA8610A	Pre-amplifier (for MA8611A)	440
MA8611A	EMI Probe Kit	331
MA9001B	Connector Adapter (for ML9001A)	59
MA9002A	Adapter (for ML9001A)	54
MA9004A	Connector Adapter (for MS9020D)	76
MA9005A	Connector Adapter (for ML9002A, MS9020D)	62, 76
MA9006A	Sensor Adapter (for ML9002A)	62
MA9008A	Connector Adapter (for MT9810A/9812B)	71
MA9013A	Fiber Adapter	124
MA9306A	Optical Attenuator (for ML9001A)	59
MA9331A	Optical Sensor (for MT9810A/9812B)	57
MA9332A	Optical Sensor (for ME7894A)	49
MA9411A/A1	Optical Sensor (for ML9001A)	57
MA9412A	Optical Sensor (for ML9001A)	57
MA9421A	Optical Power Sensor (for ML9002A, MS9020D)	57, 61, 74
MA9422A	Optical Power Sensor (for ML9002A, MS9020D)	57, 61, 74
MA9423A	Optical Power Sensor (for ML9002A, MS9020D)	57, 61, 74
MA9611A	Optical Sensor (for ML9001A)	57
MA9612A	Optical Sensor (for ML9001A)	57
MA9621A	Optical Power Sensor (for ML9002A, MS9020D)	57, 61, 74
MA9622A	Optical Power Sensor (for MS9020D)	74
MA9711A/A1	Optical Sensor (for ML9001A)	57
MA9712A	Optical Sensor (for ML9001A)	57
MA9714B	Optical Power Sensor (for ML9001A)	57
MA9721A	Optical Power Sensor (for ML9002A, MS9020D)	57, 61, 74
MA9722A	Optical Power Sensor (for ML9002A, MS9020D)	57, 61, 74
MA9723A	Optical Power Sensor (for ML9002A, MS9020D)	57, 61, 74
MA9805A	Optical Attenuator (for ML9001A)	57

MB

MB-009	50 Ω, 75 Ω Impedance Transformer	526
MB23A	Portable Test Rack	528
MB24A	Portable Test Rack	528

MD

MD0610D/D1	Word Memory Unit (for MD6420A)	204
MD0620A	GPIO Remote Control Unit (for MD6420A)	204
MD0620B	RS-232C Remote Control Unit (for MD6420A)	204
MD0621	Series X/V Series Interface (for MD6420A)	204
MD0622	Series G.703, AMI Interface (for MD6420A)	204
MD0623	Series G.703, AMI Interface (for MD6420A)	204
MD0625B/C	I.431 Interface (for MD6420A)	204
MD0626A	TTL Interface Unit (for MD6420A)	204
MD0627A	Analog Unit (for MD6420A)	204
MD0628B/C	DS1/DS1C Interface (for MD6420A)	204
MD0630A	Distortion Measurement Unit (for MD6420A)	204
MD0630B	CODEC Unit (for MD6420A)	204
MD0632	Series Jitter Unit (for MD6420A)	204
MD0633A	Error Analyzer Unit (for MD6420A)	204
MD1230A	Data Quality Analyzer	176
MD1620B	Signalling Tester	254
MD1620C	Signalling Tester	256
MD6420A	Data Transmission Analyzer	200
MD6430A	Network Data Analyzer	196
MD8480A	W-CDMA Signalling Tester	251

ME

ME3401A	Digital Transmission Analyzer	194
ME446A/B	Transmission Measuring Set	446
ME447 Series	Transmission Measuring Set	446
ME7220A	Radar Test Set (RTS)	451
ME7411A	Switch Unit for Transceiver Continuous Test (for ME7812 series)	281
ME7413A	Coaxial Switch (for ME7812 series)	281
ME7808A	Broadband Vector Network Analyzer	368
ME7812 Series	Radio Communication Test System	281
ME7840A	Power Amplifier Test System (PATS)	358
ME7890B	Optical Amplifier Test System	109
ME7894A	Optical Component Tester	48

MF

MF2400B Series	Microwave Frequency Counter	388
MF9619C	Optical Modulator (for ME7890B)	112
MF9630A	Optical Wavelength/Frequency Counter	122

MG

MG0301C	$\pi/4$ DQPSK Modulation Unit (for MG3670B/C, MG3671A/B, MG3672A, MG3660A)	221, 237
MG0302A	GMSK Modulation Unit (for MG3670B/C, MG3671A/B, MG3672A, MG3660A)	221, 237
MG0303B	Burst Function Unit (for MG3670B/C, MG3671A/B, MG3672A, MG3660A)	221, 237
MG0305A	GFSK Modulation Unit (for MG3670B/C, MG3671A/B, MG3672A, MG3660A)	221, 237

MG0307A	$\pi/4$ DQPSK Modulation Unit (for MG3670B/C, MG3671A/B, MG3672A, MG3660A)	221, 237
MG0310A	CDMA Modulation Unit (for MG3670C/3671B/3672A)	237
MG0311A	$\pi/4$ DQPSK Modulation Unit (for MG3670B/C, MG3671A/B, MG3672A, MG3660A)	221, 237
MG0312A	QPSK Modulation Unit (for MG3670C/3671B/3672A)	237
MG0902A	Modulation Unit (for MG9001A/9002A)	55
MG0914E	LED Source (for MG9001A/9002A)	55
MG0917A/B/D	LED Source (for MG9001A/9002A)	55
MG0918B/D	LED Source (for MG9001A/9002A)	55
MG0927D/J	Edge Emitting LED Source (for MG9001A/9002A)	55
MG0928D/J	Edge Emitting LED Source (for MG9001A/9002A)	55
MG3633A	Synthesized Signal Generator	424
MG3641A	Synthesized Signal Generator	419
MG3642A	Synthesized Signal Generator	419
MG3660A	Digital Modulation Signal Generator	248
MG3670B/C	Digital Modulation Signal Generator	237
MG3671A/B	Digital Modulation Signal Generator	237
MG3672A	Digital Modulation Signal Generator	237
MG3681A	Digital Modulation Signal Generator	230
MG442A	Synthesized Level Generator	429
MG443B	Synthesizer/Level Generator	429
MG724E1/G1	Signal Generator	452
MG9001A	Stabilized Light Source	54
MG9002A	Stabilized Light Source	54
MG9541A	Tunable Laser Source	45
MG9587A	SLD Light Source	52

MH

MH648A	Pre-amplifier	347
MH649A	Preselector	435
MH669B	Frequency Converter	435

ML

ML2407A Series	Power Meter	391
ML2408A Series	Power Meter	391
ML2419A	Range Calibrator (for ML2430A)	397
ML2430A	Series Power Meter	391
ML2530A	Calibration Receiver	442
ML422C	Selective Level Meter	446
ML424A/B	Level Meter	446
ML428B	Interference/Field Strength Meter	436
ML524B	Measuring Receiver	433
ML5655C	Measuring Receiver	289
ML69B	Electronic Voltmeter	398
ML8720B	W-CDMA Area Tester	278
ML9001A	Optical Power Meter	57
ML9002A	Optical Handy Power Meter	61
ML9050A	Standard Optical Power Meter	122
ML910B	Optical Power Meter	122

MN

MN510C/D	Resistance Attenuator	447
MN63A	Programmable Attenuator	452
MN64B	Programmable Attenuator	452
MN65A	Programmable Attenuator	452
MN72A	Programmable Attenuator	452
MN924C	Optical Attenuator	124
MN938A	Programmable Optical Attenuator	123
MN95D	Optical Variable Attenuator	123
MN9320A	Optical Channel Drop Unit (OCDU)	121
MN9605C	Optical Attenuator	124
MN9625A	Programmable Optical Attenuator	116
MN9626A	Programmable Optical Attenuator	116
MN9662A	Optical Channel Selector	114
MN9664A	Optical Channel Selector	114
MN9672A	Optical Channel Selector	114
MN9674A	Optical Channel Selector	114

MP

MP0105A	CMI Unit (for MP1570A/A1)	164
MP0108A	NRZ Unit (for MP1570A/A1)	164
MP0111A	Optical 156M/622M (1.31) Unit (for MP1570A/A1)	170
MP0112A	Optical 156M/622M (1.55) Unit (for MP1570A/A1)	170
MP0113A	Optical 156M/622M (1.33/1.55) Unit (for MP1570A/A1)	170
MP0121A	2/8/34/139/156M Unit (for MP1570A/A1)	170
MP0122A	1.5/45/52M Unit (for MP1570A/A1)	170
MP0122B	1.5/45/52/52M (1.31) Unit (for MP1570A/A1)	170
MP0123A	ATM Unit (for MP1570A/A1)	163
MP0131A	Add/Drop Unit (for MP1570A/A1)	164
MP1033A	DS3 Hi-Cap Test System	523
MP1201C	Error Rate Tester	289
MP1220B	ATM Quality Analyzer	182
MP1560A	STM/SONET Analyzer	194
MP1570A	SONET/SDH/PDH/ATM Analyzer	150
MP1570A1	SONET/SDH/PDH/ATM Analyzer	169
MP1580A	Portable 2.5G/10G Analyzer	172
MP1630B	Digital Data Analyzer	141
MP1632C	Digital Data Analyzer	146
MP1758A	Pulse Pattern Generator	130
MP1763C	Pulse Pattern Generator	133
MP1764C	Error Detector	136
MP1776A	Error Detector	131
MP1777A	10 GHz Jitter Analyzer	138
MP414B	Loop Antenna	437
MP415B	Rod Antenna	437
MP520 Series	CM Directional Coupler	527
MP526 Series	High-Pass Filter	528
MP534A/B	Dipole Antenna	436
MP614A	50 Ω, 75 Ω Impedance Transformer	526
MP635A	Log-Periodic Antenna	436
MP640A	Branch	527
MP651A/B	Dipole Antenna	436
MP654A	Directional Coupler	527
MP655A	Directional Coupler	527

MP659A	Four-Port Junction Pad	526
MP663A	Dipole Antenna	436
MP666A	Log-Periodic Antenna	436
MP721 Series	Fixed Attenuator (for ML2530A)	445
MP916A	Fiber Adapter (for ML9001A/9002A)	56, 59
MP922B	Bare Fiber Connector	124
MP924A	Fiber Jacket Stripper (for optical accessories)	126
MP92B	Connector Adapter (for ML9001A)	59
MP93A	Fiber Adapter (for ML9001A/9002A)	59, 62
MP94A	Adapter (for ML9001A)	54
MP94D	Adapter (for ML9002A)	59
MP9650 Series	Waveform Monitor	123
MP9677B	E/O, O/E Converter	118

MS

MS0901A	LED Source (for MS9020D)	77
MS0902A	LED Source (for MS9020D)	77
MS0902D	LD Source (for MS9020D)	77
MS0903A	LED Source (for MS9020D)	77
MS0903D	LD Source (for MS9020D)	77
MS0904A	LED Source (for MS9020D)	77
MS0904B	EE-LED Source (for MS9020D)	77
MS0905A	LED Source (for MS9020D)	77
MS0906A	LED Source (for MS9020D)	77
MS0907A	Return Loss Unit (for MS9020D)	77
MS0908A	FP-LD Source (for MS9020D)	77
MS0909A	FP-LD Source (for MS9020D)	77
MS2651B	Spectrum Analyzer	339
MS2661B	Spectrum Analyzer	339
MS2661C	Spectrum Analyzer	332
MS2663C	Spectrum Analyzer	326
MS2665C	Spectrum Analyzer	321
MS2667C	Spectrum Analyzer	315
MS2668C	Spectrum Analyzer	310
MS2683A	Spectrum Analyzer	305
MS2711B	HandHeld Spectrum Analyzer	294
MS369B	PCM CODEC Analyzer	194
MS371A/A1	PCM Channel Analyzer	188
MS4622A	Network Analyzer Measurement System	350
MS4622B	Network Analyzer Measurement System	350
MS4622C	Vector Network Measurement System, Direct-Access Receiver	356
MS4623A	Network Analyzer Measurement System	350
MS4623B	Network Analyzer Measurement System	350
MS4623C	Vector Network Measurement System, Direct-Access Receiver	356
MS4630B	Network Analyzer	381
MS555B	Radio Communication Analyzer	435
MS75B	Microwave Repeater Checker	452
MS8604A	Digital Mobile Radio Transmitter Tester	220
MS8608A	Digital Mobile Radio Transmitter Tester	213
MS8609A	Digital Mobile Radio Transmitter Tester	207
MS9020D	Optical Loss Test Set	73
MS9710B	Optical Spectrum Analyzer	95
MS9710C	Optical Spectrum Analyzer	90
MS9715A	WDM Tester	107
MS9720A	WDM Network Tester	100
MS9780A	Optical Spectrum Analyzer	103

MT

MT8801C	Radio Communication Analyzer	269
MT8820A	Radio Communication Analyzer	265
MT8850A	Bluetooth™ Test Set	259
MT9810A	Optical Test Set	64
MT9810B	Optical Test Set (for ME7894A).....	50
MT9812B	Multi Channel Box	70

MU

MU120001A	STM-4/OC-12 Unit (for MP1220A).....	183
MU120002A	STM-1/OC-3 Unit (for MP1220A).....	183
MU120010A	T1/T3 Unit (for MP1220A).....	184
MU120011A	E1/E3/E4 Unit (for MP1220A).....	184
MU120012A	E1/E3 Unit (for MP1220A).....	184
MU120015A	ATM 25M Unit (for MP1220A).....	185
MU120016A	6.3M Unit (for MP1220A).....	185
MU120017A	6.3/25M Unit (for MP1220A).....	185
MU120020A	QoS Unit (for MP1220A).....	186
MU120021A	Protocol Unit (for MP1220A).....	186
MU120101A	10M/100M Ethernet Module (for MD1230A).....	179
MU120102A	Gigabit Ethernet Module (for MD1230A).....	179
MU120103A	2.5G (1.31) Module (for MD1230A).....	180
MU120104A	2.5G (1.55) Module (for MD1230A).....	180
MU120105A	10G (1.31) Module (for MD1230A).....	180
MU120106A	10G (1.55) Module (for MD1230A).....	176
MU150000A	2.5G/10G Unit (for MP1570A/A1).....	170
MU150001A/B	Optical 10G Tx (1.55) Unit (for MP1570A/A1).....	170
MU150002A	Optical 10G Rx (Narrow) Unit (for MP1570A/A1).....	170
MU150005A	2/8/34/139M, 156/622M Jitter Unit (for MP1570A/A1).....	170
MU150006A	1.5/45/52M, 156/622M Jitter Unit (for MP1570A/A1).....	170
MU150007A	2/8/34/139M, 1.5/45/52M, 156/622M Jitter Unit (for MP1570A/A1).....	170
MU150008A	2.5G (1.31) Unit (for MP1570A/A1).....	170
MU150009A	2.5G (1.55) Unit (for MP1570A/A1).....	166
MU150010A	2.5G (1.31/1.55) Unit (for MP1570A/A1).....	166
MU150011A	2.5G Jitter Unit (for MP1570A/A1).....	168
MU150017A	Optical 10G Rx (Wide) Unit (for MP1570A/A1).....	170
MU150017B	Optical 2.5G/10G Rx (Wide) Unit (for MP1570A/A1).....	170
MU150018A	2.5G/10G Jitter Unit (for MP1580A).....	168
MU150031A	Optical 10G Tx (1.55) High Power Unit (for MP1570A/A1).....	170
MU150031C	Optical 2.5G/10G Tx (1.55) High Power Unit (for MP1570A/A1).....	170
MU150061A	Optical 10G Tx (1.31) Unit (for MP1570A/A1).....	170
MU150061B	Optical 2.5G/10G Tx (1.31) Unit (for MP1570A/A1).....	170
MU163000A	200M Clock Generator Unit (for MP1630B).....	145
MU163020B	200M 16CH Pulse Pattern Generator Unit (for MP1630B).....	145

MU163040B	200M 16CH Error Detector Unit (for MP1630B).....	145
MU163220C	3.2G Pulse Pattern Generator (for MP1632C).....	145
MU163240C	3.2G Error Detector (for MP1632C).....	145
MU177601B	12.5 Gb/s Error Detector Unit (for MP1776A).....	132
MU250000A Series	Display Unit (for MW9076 series).....	84
MU250001A	Display Unit (for MW9076 series).....	84
MU368010A	TDMA Modulation Unit (for MG3681A).....	236
MU368040A	CDMA Modulation Unit (for MG3681A).....	236
MU368041A	W-CDMA Software (for MG3681A).....	231
MU368060A	AWGN Unit (for MG3681A).....	236
MU643000A	Datacom Interface Unit (for MD6430A).....	199
MU643000B	Datacom Interface Unit (for MD6430A).....	199
MU643000C	Datacom Interface Unit (for MD6430A).....	199
MU848051A	CPU (for MD8480A).....	251
MU848052A	Frame Decoder (for MD8480A).....	253
MU848053A	Rx Baseband (for MD8480A).....	253
MU848055A	ISDN (for MD8480A).....	251
MU848056A	Voice Codec (for MD8480A).....	251
MU848057A	Frame Coder (for MD8480A).....	251
MU848058A	Tx Baseband (for MD8480A).....	251
MU848059A	Timing Generator (for MD8480A).....	251
MU931001A	Sensor Adapter (for MT9810A/9812B).....	68
MU931002A	Sensor Adapter (for ME7894A).....	51
MU931311A	Optical Sensor (for MT9810A/9812B).....	56, 59
MU931421A	Optical Sensor (for MT9810A/9812B).....	56, 59
MU931422A	Optical Sensor (for MT9810A/9812B).....	56, 59
MU951001A	Light Source (for MT9810A/9812B).....	56, 59
MU951301A	Light Source (for MT9810A/9812B).....	56, 59
MU951501A	Light Source (for MT9810A/9812B).....	56, 59
MU952501A	Light Source (for MT9810A/9812B).....	56, 59
MU952502A	Light Source (for MT9810A/9812B).....	56, 59
MU952503A	Light Source (for MT9810A/9812B).....	56, 59
MU952504A	Light Source (for MT9810A/9812B).....	56, 59
MU952505A	Light Source (for MT9810A/9812B).....	56, 59
MU952601A	Light Source (for MT9810A/9812B).....	56, 59
MU952602A	Light Source (for MT9810A/9812B).....	56, 59
MU952603A	Light Source (for MT9810A/9812B).....	56, 59
MU952604A	Light Source (for MT9810A/9812B).....	57, 59
MU952605A	Light Source (for MT9810A/9812B).....	57, 59
MU952606A	Light Source (for MT9810A/9812B).....	57, 59
MU960001A	Optical Channel Selector Unit (for MW9076 series).....	83
MU960002A	Optical Channel Selector Unit (for MW9076 series).....	83
MU967701A	Clock Recovery Unit (for MP9677B).....	118
MU967702A	Clock Recovery Unit (for MP9677B).....	118

MW

MW0944B	SMF 1.31/1.55 μm Unit (for MW9060A).....	89
MW0945B	SMF 1.31 μm Unit (for MW9060A).....	89
MW0947B	SMF 1.31/1.55 μm Unit (for MW9060A).....	89
MW0967B	GIF 0.85/1.30 μm Unit (for MW9060A).....	88
MW9060A	Optical Time Domain Reflectometer (OTDR)	85
MW9076 Series	Optical Time Domain Reflectometer (OTDR)	78

MX

MX122020A	Protocol Decoding Software (for MP1220A).....	186	MX785101A	W-CDMA Virtual Signaling System	286
MX123001A	Data Quality Analyzer Control Software (for MD1230A)	181	MX785201A	W-CDMA Protocol Test System (PTS)	286
MX150001B	Wander (MTIE, TDEV) Measurement Application Software (for MP1570A/A1)	165	MX789400A	Optical Component Tester Control Software (FD) (for ME7894A)	49
MX150002A	Wander Measurement Application Software (MTIE/TDEV) (for MP1580A).....	173	MX848000A	W-CDMA Signalling Tester Control software (for MD8480A)	252
MX163201A	TEXT to MP1632A/C Pattern Conversion Software (for MP1632C)	146	MX848001A	W-CDMA Signalling Tester Firmware (for MD8480A)	252
MX163202A	MP165X to MP1632A/C Pattern Conversion Software (for MP1632C)	146	MX848002A	W-CDMA Signalling Tester FPGA (for MD8480A)	252
MX163205A	Q and Eye Analysis Software (for MP1632C)	146	MX848003A	W-CDMA Signalling Tester ISDN/PPP (for MD8480A)	252
MX163206A	SDH/SONET Pattern Editor (for MP1632C)	146	MX848041A	W-CDMA Signalling Tester Ciphering (for MD8480A)	252
MX176400A	Q and Eye Analysis Software (for MP1763C/1764C)	133	MX860801B	W-CDMA Measurement Software (for MS8608A)	213
MX176401A	SDH/SONET Pattern Editor (for MP1763C/1764C)	133	MX860802A	GSM Measurement Software (for MS8608A)	213
MX260002A	CDMA Cellular System Measurement Software (for MS2650/2660 series)	331, 338, 346	MX860901B	W-CDMA Measurement Software (for MS8609A)	208
MX260003A	PDC Measurement Software (for base station) (for MS2650/2660 series)	331, 338, 346	MX860902A	GSM Measurement Software (for MS8609A)	208
MX260004A	GSM Measurement Software (for MS2650/2660 series)	331, 338, 346	MX860801A	W-CDMA Measurement Software (for MS8608A)	213
MX261001A	Low-Power Data Communication System Measurement Software conforming to issue of Direct Spread Spectrum System (for MS2650/2660 series)	331, 338, 346	MX880113A	IS-136A Measurement Software (for MT8801C)	277
MX261002A	Low-Power Data Communication System Measurement Software conforming to issue of Frequency Hopping System (for MS2650/2660 series)	331, 338, 346	MX880114A	AMPS/PCS1900 Measurement Software (for MT8801C)	277
MX262001A	CATV Measurement Software (for MS2650/2660 series)	331, 338, 346	MX880115A	GSM Measurement Software (for MT8801C)	277
MX264001A	EMI Measurement Software (for MS2650/2660 series)	331, 338, 346	MX880116A	PDC Measurement Software with Call Processing (for MT8801C)	270
MX268001A	File Transfer Utility (for MS8608A/8609A).....	219	MX880117A	PHS Measurement Software with Call Processing (for MT8801C)	270
MX268001A	File Utility Software (for MS2683A).....	309	MX880118A	DECT Measurement Software (for MT8801C).....	276
MX268301A	W-CDMA Measurement Software (for MS2683A)	309	MX880131A	PDC Measurement Software (for MT8801C).....	276
MX268302A	GSM Measurement Software (for MS2683A)	309	MX880132A	PHS Measurement Software (for MT8801C).....	277
MX3512A	$\pi/4$ DQPSK Analysis Software (for MS8604A)	221	MX882000A	W-CDMA Measurement Software (for MT8820A)	265
MX3513A	Digital MCA Analysis Software (for MS8604A)	229	MX907601A	OTDR Emulation Software (for MW9076 series) ..	84
MX3518A	GMSK Application Software (for MS8604A)	236	MX972001G	LabVIEW® Driver (GPIB) (for MS9720A)	102
MX3519A	DECT Application Software (for MS8604A)	229	MX972001S	LabVIEW® Driver (RS-232C) (for MS9720A).....	102
MX3520A	CT2 Application Software (for MS8604A)	229			
MX364001B	Software for Pattern Generator Data Write (for MG3641A/3642A)	423			
MX368011A	PDC Software (for MU368010A)	236			
MX368012A	GSM Device Test Software (for MU368010A)	236			
MX368041A	W-CDMA Software (for MU368040A)	234			
MX368042A	IS-95 Device Test Software (for MU368040A)	236			
MX5126B	Frequency-Response Compensation Software (for MG3633A)	428			
MX5251B	Frequency-Response Compensation Software (for MG3633A)	428			
MX781217A	PHS Software (for ME7812 series).....	285			
MX781250A	Level Correction Software (for ME7812 series)	281			

MZ

MZ106C	Mode Scrambler (for optical accessories)	128
MZ110A/B	Battery Pack (for ML524B).....	434
MZ114A	AC Power Pack (for ML524B)	434
MZ115B	Battery Charger (for ML524B)	434
MZ137A	Battery Pack (for ML524B).....	434
MZ8010A	Optical Sensor Holder (for ML9001A).....	59
MZ8013A	Sensor Holder (for ML9002A)	61

N

N241 Series	Power Splitters	506
NC346A	5 dB ENR Noise Source (3.5 mm).....	355
NC346B	15 dB ENR Noise Source (3.5 mm).....	355

S

S100C Series Site Master297
S200C Series Site Master297
S300C Series Site Master297
S800A Series Site Master297

V

V Series Connectors461
V115FCPW Integrated V Connector465
V115FMS10 Integrated V Connector465
V115FMS75 Integrated V Connector465
V116F Integrated V Connector465
V120 Series RF Cables467
V240 Power Dividers504
V241 Series Power Splitters505
V250 Bias Tees507
V251 Ultra-Wideband Bias Tees507
V255 Ultra-Wideband Bias Tee 510
V261 Precision DC Blocks512
V265 DC Block514

Z

Z-164A/B T-Pad 526

For Evaluating Characteristics of WDM Transmission Systems and Optical Components**MG9541A Tunable Laser Source**

1510 to 1640 nm

The MG9541A covers the wavelength band from 1510 to 1640 nm with three outputs — a variable optical level output, a high power output and a high signal-to-noise ratio output. The MG9541A supports a wide variety of applications including optical amplifier evaluation systems and evaluation of characteristics of optical components used in WDM transmission systems.

(For further information see page 45)

**For Evaluating Passive Optical Devices such as WDM and Fiber Amplifiers****ME7894A Optical Component Tester**

The ME7894A is used in conjunction with the MG9541A Tunable Laser Source, the MT9810B Optical Test Set and the MA9332A Optical Sensor to configure a high-speed measurement system for optical components (filters, couplers, isolators, etc.) used in WDM transmission systems. The measurement can be easily set up over a wide wavelength range from C-band (1530 to 1565 nm) to L-band (1565 to 1625 nm).

(For further information see page 48)



High Attenuation Accuracy, Low Polarization Dependent Loss, Excellent Wavelength Flatness
MN9625A/9626A Programmable Optical Attenuator

1.2 to 1.65 μm



The MN9625A/9626A Programmable Optical Attenuator has excellent attenuation accuracy. It is calibrated with a high-accuracy calibration system over an attenuation range of 0 to 60 dB.

The MN9625A has a superior wavelength flatness of 0.2 dBp-p max. by using an attenuation element with very flat wavelength characteristics. It is the ideal instrument for evaluating WDM (wavelength division multiplexing) optical amplifiers in which gain flatness vs. wavelength is an important factor. Moreover, the MN9626A has a built-in optical monitor output for monitoring the level of through light.

(For further information see page 116)

DWDM Channel Access & Test

MN9320A Optical Channel Drop Unit (OCDU)



The Anritsu Optical Channel Drop Unit (OCDU), MN9320A is an independent test access tool for comprehensive DWDM measurements. The OCDU is a test instrument that scans the DWDM optical signal and displays all those channels present in the form of a bar graph or a tabulation of channel and power. Any individual channel can be selected from this display and fed to its output port, which can then be connected to a protocol analyzer such as the Anritsu MP1570A for data validation and testing. Wherever the integrity of a DWDM signal must be verified, the MN9320A can be used.

(For further information see page 121)

Supports Measurement for up to 50 Gbit/s System (Installed with 4 Channels)

MP1776A Error Detector

100 MHz to 12.5 GHz

MP1776A is an error detector housing four error detectors that can measure error up to 12.5 Gbit/s. It has four-channels independent measurement mode, two-channels or four-channels combined measurement mode and be used for development, manufacturing and maintenance of transmission systems and modules from 12.5 Gbit/s to maximum 50 Gbit/s.

(For further information see page 131)



Supports North American and European Mapping by One Box

MP1570A1 SONET/SDH/PDH/ATM Analyzer

1.5 Mbit/s to 10 Gbit/s

MP1570A1 is a SONET/SDH/PDH/ATM Analyzer which has one more slot compared with MP1570A. It can measure bit rate of 2488M (OC-48) or more in North American and European mapping without the DSn and PDH plug-in units exchange.

(For further information see page 169)

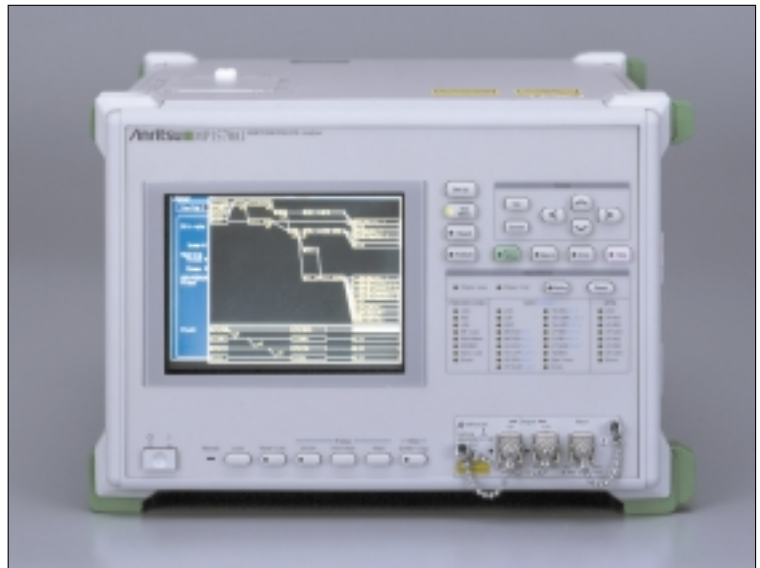

For 2.5G/10G Jitter/Wander Measurements

MP1580A Portable 2.5G/10G Analyzer

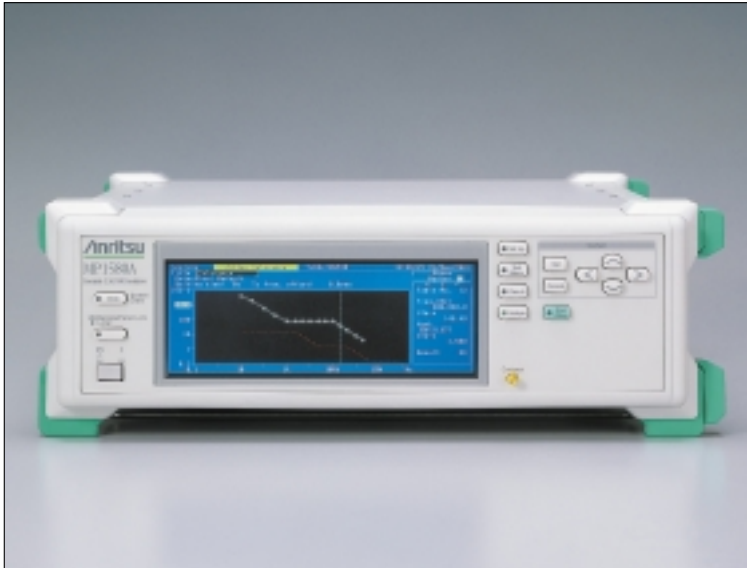

The MP1580A is a unique and powerful solution for analyzing jitter at the standard OC-48/192 or STM-16/64 bit rates. It can measure jitter of 2.5G/10G electrical interfaces (clock signal) with a simple operation. In addition, when used in combination with the MP1570A SONET/SDH/PDH/ATM Analyzer, evaluation of jitter characteristics in digital transmission lines, systems and devices, such as — jitter tolerance, jitter transfer, jitter generation, etc., can be performed easily.

(For further information see page 172)

Complete Performance Testing and Monitoring with One Unit

MD1230A Data Quality Analyzer



IP Networks are spreading rapidly throughout society, in line with the expansion of networks carrying voice, video, and mission-critical data. The maintenance of network quality has now become an important theme.

Development of network equipment and systems requires the measurement of network performance and QoS evaluations. In addition, network operations and maintenance require monitoring of in-service traffic, latency, and frame arrival time variation (frame jitter) as well as prompt troubleshooting.

The MD1230A integrates both performance testing and network monitoring into one instrument.

(For further information see page 176)

Measures Wide-Band Signals up to IMT-2000 2 Mbit/s

MS8609A Digital Mobile Radio Transmitter Tester

9 kHz to 13.2 GHz

The MS8609A is a transmitter tester equipped with an internal spectrum analyzer, a modulation analyzer and a power meter. One tester covers the development, manufacturing of base stations, mobile stations to construction, maintenance of base stations.

The spectrum analyzer has resolution bandwidths up to 20 MHz, meaning, that it can readily support measurement of a 2 Mbit/s (16 Mcps) wide-band signal for IMT-2000.

The modulation analyzer realizes all Vector Signal Analysis (VSA) functions through high-speed DSP. The power sensor can perform highly accurate power measurements of ± 0.4 dB by using an amorphous power sensor. Up to three dedicated measurement software options (such as W-CDMA and GSM/EDGE) can be installed simultaneously. Input signals can be selected from either RF or I/Q inputs. For I/Q signals, balanced or unbalanced input can also be selected.

It is equipped with GPIB, RS-232C and 10 Base-T (optional) interfaces for remote measurement. High-speed GPIB data transmission of 120 kbyte/s enables high-speed measurement on the manufacturing line. The monitor uses an easy-to-see 6.5 type TFT color LCD.



(For further information see page 207)

For the Development of W-CDMA Mobile Stations

MD8480A W-CDMA Signalling Tester

The MD8480A has a full lineup of advanced functions for testing third-generation W-CDMA mobile stations. Its air interface meets the 3GPP specifications, and it can be used as a base station simulator.

The test functions include mobile station modulation and demodulation processing, protocol sequence tests such as location registration, origination, termination, handover (option), disconnection from mobile station/network, various applications such as voice and packet communications as well as communications between two mobile stations.

In summary, the MD8480A is the ideal instrument for developing 3G W-CDMA mobile stations and application software.



(For further information see page 251)

Test Bluetooth Modules and Products with a Bluetooth Interface

MT8850A Bluetooth™ Test Set

2.4 GHz Reference Bluetooth Transceiver



The MT8850A is Anritsu's entrant into the fast-growing *Bluetooth* world of wireless communications for mobile PCs, mobile phones and other portable devices. The MT8850A *Bluetooth* Test Set measures the radio performance of *Bluetooth* modules and *Bluetooth* products – quickly and at low cost. MT8850A is qualified as a *Bluetooth* development tool.

(For further information see page 259)



Supports Third Generation W-CDMA

MT8820A Radio Communication Analyzer

30 MHz to 2.7 GHz



The MT8820A hardware platform covers a frequency range of 30 MHz to 2.7 GHz.

When dedicated measurement software and hardware (options) are installed, this single platform supports evaluation of all the main transmission/reception test items for W-CDMA terminals.

Advanced DSP and parallel measurement technologies dramatically reduce wireless manufacturing and inspection test times. Furthermore, several measurement items can be selected freely for batch measurement.

A one-touch operation also allows for each selected batch measurement item to be executed repeatedly for a designated number of times. Pass/fail evaluation of the main measurement items including transmission frequency, modulation accuracy, output power, adjacent channel power, occupied frequency bandwidth, BER, etc., can be performed easily and quickly.

(For further information see page 265)

For W-CDMA Base Station Area Investigation and Maintenance**ML8720B W-CDMA Area Tester**

2110 to 2200 MHz

The ML8720B is used for investigation and maintenance to evaluate the radio wave propagation characteristics in the area of a W-CDMA base station. When it is connected to a GPS receiver, the measured data can be correlated with positioning information (latitude and longitude). The measurement items include functions for measuring the RSCP*¹, Ec/No*² and SIR*³, which is used to evaluate the strength of the radio wave received from each base station; and the delay profile, which is used to evaluate the delay characteristics of the radio wave caused by multipath propagation.

There are two measurement modes: the unspecified base station measurement mode, and the specified base station measurement mode. The CPICH*⁴ from the base station is measured in both cases. In the unspecified base station measurement mode, measurement is performed without knowing the base station scrambling code.

In the specified base station measurement mode, measurement is performed using the known base station scrambling code.

(For further information see page 278)

**Fast, Accurate, Repeatable, Portable Spectrum Analysis****MS2711B Handheld Spectrum Analyzer**

100 kHz to 3.0 GHz

The MS2711B Handheld Spectrum Analyzer provides the "ultimate" in measurement flexibility for field environments and applications requiring mobility. Unlike traditional spectrum analyzers, the MS2711B features a rugged, ultra-lightweight, battery-operated design that enables users to conduct spectrum analysis measurements – anywhere, anytime.

Providing complete freedom from AC/DC power requirements, the MS2711B enables you to locate, identify, record and solve communication systems problems quickly and easily, without sacrificing measurement accuracy.

Whether you are installing, maintaining, or troubleshooting a modern wireless communication system, the MS2711B provides exceptional performance combined with ease-of-use and broad functionality – making it an ideal solution for engineers and technicians who conduct field measurements in the 100 kHz to 3.0 GHz frequency range.

To meet the challenges of today's wireless market, Anritsu Company has developed a new pre-amp option (option 8) for its revolutionary MS2711B hand-held spectrum analyzer which increases the analyzer's sensitivity and dynamic range while improving measurement time. With the pre-amp option, the MS2711B is particularly effective in measuring low-level signals. The handheld spectrum analyzer's sensitivity is improved to -114 dBm (full span). With this option, the MS2711B can identify and make measurements on low-level signals much faster than previously possible.

The improved sensitivity, dynamic range, and measurement speed complement the existing benefits of the MS2711B. Weighing only 4.9 pounds (including a NiMH battery, fully loaded, base model only at 4.5 pounds), the MS2711B is the world's lightest fully functional hand-held spectrum analyzer with the built-in tracking generator option (option 20).



(For further information see page 294)

Development and Proving 3G Terminals

MX785101A,

MX785201A

W-CDMA Virtual Signaling Tester (VST), W-CDMA Protocol Test System (PTS)

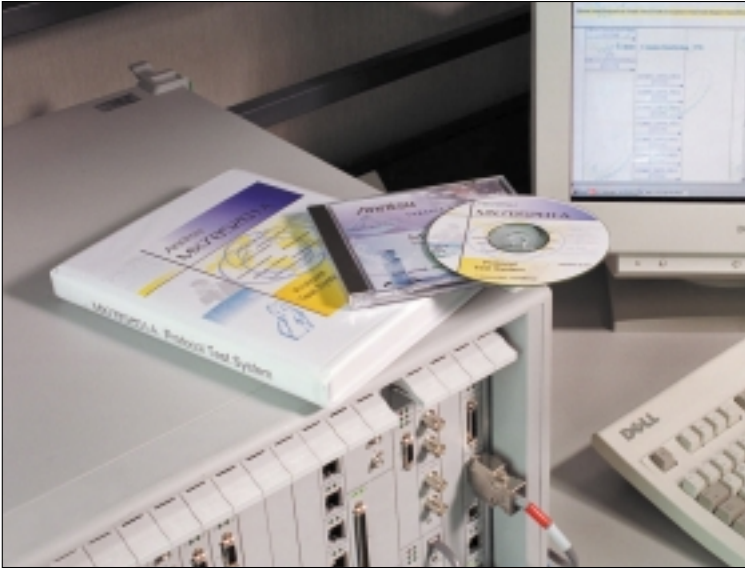

The MX785101A VST (Virtual Signaling Tester) and MX785201A PTS (Protocol Test System) is a family of test and verification tools from Anritsu for next generation wireless products. They have been developed to provide the test support today's research and development engineers need to successfully meet demanding performance and time to market targets.

They provide a common user interface thus reducing operator learn time as development progresses and migrates over the range of Anritsu's 3G development tools. In addition, test procedures generated for the PTS can be run on the VST and vice versa. This enables test procedures to be developed very early in the development cycle and to evolve as the user equipment evolves. A substantial saving in the investment in development of test procedures can be realized.

(For further information see page 286)

For Analyzing Antenna Problems

S113C Site Master

2 to 1600 MHz



The Site Master S113C is a precision, hand-held instrument that performs Return Loss/SWR and fault location in cable and antenna systems. The Site Master S113C offers frequency coverage, from 2 MHz to 1600 MHz. Light weight, rugged design, and wide temperature range make them ideal for Cellular, HF, Broadcast, and SMR field applications. Site Master's proprietary design provides superior On-channel RF immunity, which is important for live site testing. A RF power monitor is available to make common power measurements in the field.

(For further information see page 297)

For Analyzing Antenna Problems**S114C Site Master**

2 to 1600 MHz, Spectrum Analysis 100 kHz to 1600 MHz

The Site Master S114C is a precision, hand-held instrument that performs return loss/SWR and fault location in cable and antenna systems. The Site Master S114C offers frequency coverage, from 2 MHz to 1600 MHz. Built-in spectrum analysis capability from 100 kHz to 1600 MHz provides the technicians and field engineers the ability to identify and solve RF systems problems like coverage, interference, antenna alignment and other path related signal problems. Light weight, rugged design, and wide temperature range make them ideal for Cellular, HF, Broadcast, SMR field applications. Site Master's proprietary design provides superior On-channel RF immunity, which is important for live site testing. A RF power monitor is available to make power measurements in the field.

(For further information see page 297)

**For Analyzing Antenna Problems****S251C Site Master**

625 MHz to 2500 MHz

The Site Master S251C is a broadband two-port transmission line and antenna analyzers that performs return loss/SWR, fault identification, insertion gain, insertion loss, in the analog (GSM900 and AMPS) and digital cellular service (GSM1800 and PCS1900) providers that perform installation and periodic maintenance verification. The S251C features selectable output level of -30 dBm and an optional Bias Tee, to perform two-port insertion gain measurements of TMA without the need of an external supply through the PDU (Power Distribution Unit). This simplifies the technician's task of verifying the performance and operation of the tower mounted amplifier in the field. The Site Master S251C's +6 dBm output level is used for antenna isolation measurements to help confirm operation of multiple systems on the same tower. Its high dyn

(For further information see page 297)



For Analyzing Antenna Problems

S331C Site Master

25 to 4000 MHz



The Site Master S331C is a precision, hand-held instrument that performs return loss/SWR and fault location measurements. The Site Master S331C offers broad frequency coverage, from 25 MHz to 4000 MHz. Light weight, rugged design, and wide temperature range make them ideal for HF, Broadcast, Cellular, GSM1800, PCS1900, GPS, ISM, Avionics field applications. Site Master's proprietary design provides superior On-channel RF immunity, which is important for live site testing.

(For further information see page 297)

For Analyzing Antenna Problems

S332C Site Master

25 to 3300 MHz, Spectrum Analysis 100 kHz to 3000 MHz



The Site Master S332C is a precision, hand-held instrument that performs return loss/SWR and fault location measurements in cable and antenna systems. The Site Master S332C offers frequency coverage, from 25 MHz to 3300 MHz. Built-in spectrum analysis capability from 100 kHz to 3000 MHz provides the technicians and field engineers the ability to identify and solve RF systems problems like coverage, interference, antenna alignment and other path related signal problems. Lightweight, rugged design, and wide temperature range make them ideal for HF, Broadcast, Cellular, GSM1800, PCS1900, GPS, ISM, Avionics field applications. Site Master's proprietary design provides superior On-channel RF immunity, which is important for live site testing. A RF power monitor is available to make power measurements in the field.

(For further information see page 297)

Broadband S-Parameter Measurements to 110 GHz**ME7808A Broadband Vector Network Analyzer**

40 MHz to 110 GHz

The ME7808A Broadband Vector Network Analyzer (VNA) is a high performance measurement solution that covers 40 MHz to 110 GHz in a single fast sweep. Built on the advanced technology of the Anritsu Lightning 65 GHz VNA, the ME7808A is ideal for making accurate S-parameter measurements of components and devices to 110 GHz. The flexible system architecture of the ME7808A makes it easy to adapt to multiple measurement applications.

(For further information see page 368)

**The Ideal Local Oscillator for RF and Microwave Applications****MG3690A Synthesized CW Generator**

0.1 Hz to 40 GHz

The MG3690A leverages the proven design of the EI Toro family of Anritsu synthesizers, adding new features to meet the latest needs of the new millennium. The EI Toro platform gives the MG3690A excellent performance with a proven reliability record of greater-than 49,000 hours MTBF. This allows the MG3690A to offer a standard 3-year warranty. From the sleek new lines of the front panel, the larger 1/4 VGA LCD, the reduced front panel buttons and menu depth, to the 10 kg lighter and 15 cm shallower depth, the MG3690A meets the new millennium value-based needs.

- Broad frequency coverage including 0.1 Hz to 40 GHz in a single coax output
- Ultra-low SSB phase noise and spurious
- +17 dBm guaranteed leveled power to 20 GHz
- 0.01 Hz frequency resolution
- <5 ms switching time for <100 MHz sweep steps
- Digital frequency sweep and digital power sweep
- Wide dynamic range with accurate output levels
- Intuitive, menu-driven front panel

(For further information see page 400)



Target Simulation & Signal Analysis for Automotive Radar; Exceptional Performance at an Affordable Price
ME7220A Radar Test System (RTS)

76 to 77 GHz



The ME7220A Radar Test System (RTS) accurately and repeatedly characterizes 76-77 GHz automotive radar modules and systems, in a confined and controlled environment, to ensure quality and optimum functionality. The RTS is designed to work with current and future generations of automotive radar, including Adaptive Cruise Control (ACC) radar and collision warning or avoidance radar. The test system provides a simulated radar target response with one of two set target ranges with an adjustable target Radar Cross Section (RCS). The signal response can be Doppler shifted to simulate the speed of a moving target. The system also allows the measurement of the power characteristics or Effective Isotropic Radiated Power (EIRP) of the transmitted radar signal as well as its spectral characteristics (bandwidth, spurious signals, AM/FM Noise, etc.).

(For further information see page 450)

Hermetic Connector; Easy Installation
Integrated V Connectors

DC to 65 GHz



The Integrated V Connector® family is a group of female connectors which have the launcher and the glass bead integrated into one piece. All compensation steps for matching to Microstrip or Coplanar Waveguide (CPW) are included in the solder-in hermetic* connectors, ensuring that they deliver excellent performance. The integrated V connectors come in two easy-to-install styles: the solder-in version, which is the V115F group, and the V116F screw-in version, which allows more versatility of microcircuit launch design. These connectors, except for the CPW version, are designed to be used with the V110-1 Stress Relief Contacts. The Integrated V connectors are compatible with other V Connectors.

(For further information see page 465)

*Ideal for Optical Communications***V255 Ultra-Wideband Bias Tee**

50 kHz to 65 GHz

The V255 Gen II Ultra Wideband Bias Tee is designed to meet the high electrical performance requirement of passive components in optical communication networks. Given a broader bandwidth of 50 kHz to 65 GHz, with low insertion losses and very good return loss, makes it ideal to use in 40 Gbps systems to bias optical modulators and broad band data drivers. It's fast rise time and flat group delay performance allows extremely accurate measurements within a laboratory environment. The V255 Bias Tee comes with a standard V Connector® that assures excellent impedance match across the available wide bandwidth. The DC signal can be applied or extracted from the bias tee through an SMC connector at the third port. As with our other bias tees, the V255 also has a one-year warranty.

(For further information see page 510)

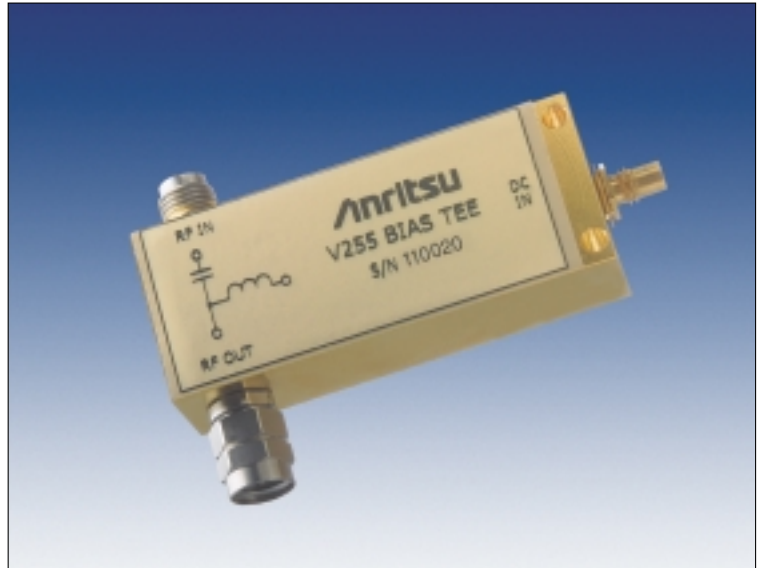
*Ideal for Optical Communications and High-Speed Pulse Applications***V265 DC Block**

50 kHz to 65 GHz

The V265 DC Block has been designed and optimized for optical communications and other high speed pulse, data or microwave applications. Based on the coaxial resilient connection – which is the same as on our V255 Gen II Bias Tee – it provides excellent low frequency response with very low losses and flat group delay over the temperature of operation. Designed to apply AC drive signals to a device while eliminating any DC voltage or current components, the V265 DC Block can be used in isolating DC leakage between two electrical components. The DC block comes with a standard V Connector® and assures excellent impedance match across the wide bandwidth available. A one-year warranty is provided.

(For further information see page 514)



*Monitor, Access and Test***MP1033A DS3 Hi-Cap Test System**

The Anritsu MP1033A is a combination access, test and performance monitor system for DS3 circuits. It enables a service provider to non-intrusively determine the quality of the signal at the DSX3 in the central office as well as at the point where service is delivered to the customer. It can be the tool to provide documented proof-of-service quality to the end user, or at the point of hand-off between an ILEC and a CLEC. In the event of an outage, the equipment can help pinpoint faults - and the responsible party - to support quick service restoration.

(For further information see page 523)

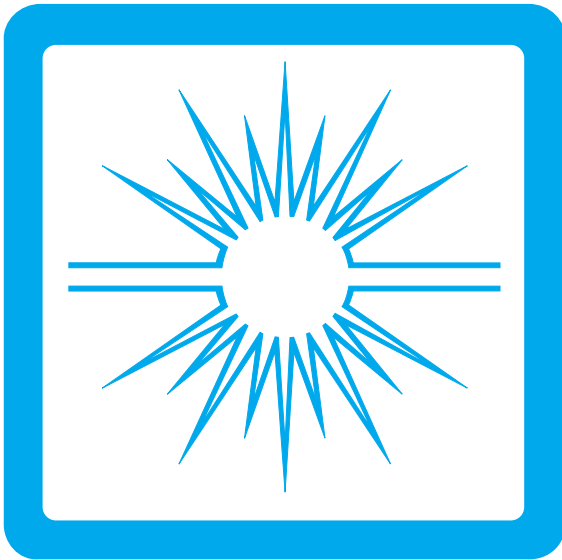

OPTICAL MEASURING INSTRUMENTS

Selection Guide	38
Tunable Laser Source	45
Optical Component Tester	48
SLD Light Source	52
Stabilized Light Source	54
Optical Power Meters	57, 122
Optical Handy Power Meter	61
Optical Test Set	64
Multi Channel Box	70
Optical Loss Test Set	73
Optical Time Domain Reflectometers	78, 85
Optical Spectrum Analyzers	90, 95, 103
WDM Network Tester	100
WDM Tester	107
Optical Amplifier Test System	109
Optical Channel Selector	114
Programmable Optical Attenuator	116, 123
E/O, O/E Converter	118
Optical Directional Coupler	120
Optical Channel Drop Unit	121
Optical Wavelength/Frequency Counter	122
Waveform Monitor	123
Optical Attenuators	123, 124
Bare Fiber Connector	124
Fiber Adapter	124
Remote Fiber Test System	125
Optical Accessories	126

Selection guide

Model	Application	Optical power		Light source wavelength		Loss		Optical identification		Optical return loss measurement		Baseband characteristic		Fiber evaluation		Laser diode testing	Others	Remarks
		Low level	Medium/high level	Spectrum Wavelength	High-loss	High accuracy	Loss-wavelength	Identification	Loss	Optical return loss	End-to-end	Loop-back	O/E Converter and waveform	E/O Converter	Fault location			
Light sources	MG9001A					√	√			√				√	√			0.85/1.31/1.55 μm (LD, LED)
	MG9002A					√	√			√				√	√			
Tunable laser sources	MG9541A					√	√	√									√	1.500 to 1.580 μm
SLD light source	MG9587A					√	√											1.45 to 1.65 μm
Optical power meters	ML9001A	√	√			√	√			√					√			-100 to +10 dBm
	ML9002A			√				√		√					√			-70 to +20 dBm
	ML910B	√	√			√	√			√					√			-90 to +20 dBm
Standard optical power meter	ML9050A		√															0.4 to 1.8 μm
Optical wavelength/frequency counter	MF9630A				√													0.6 to 1.6 μm (187 to 500 THz)
Optical test set	MT9810A	√	√			√	√		√	√	√				√			0.75 to 1.7 μm
Multi channel box	MT9812B	√	√					√	√	√					√			0.75 to 1.7 μm
Optical loss test set	MS9020D		√					√	√	√	√				√			0.85/1.3/1.55 μm
Optical spectrum analyzer	MS9710B	√	√	√	√	√		√		√						√		0.6 to 1.75 μm
	MS9710C	√	√	√	√	√		√		√						√		0.6 to 1.75 μm
	MS9780A	√	√	√	√	√		√		√						√		0.6 to 1.75 μm
WDM network tester	MS9720A	√	√	√	√			√		√					√			1.450 to 1.650 μm
WDM tester	MS9715A	√	√	√	√			√										1.527 to 1.567 μm
Optical amplifier test system	ME7890B	√	√	√	√			√										1.530 to 1.570 μm
Optical time domain reflectometers	MW9060A														√	√		1.31/1.55 μm (SM), 0.85/1.30 μm (GI)
	MW9076 series		√				√		√	√	√				√	√		1.31/1.45/1.55/1.625 μm (SM)
Optical attenuators	MN938A					√												0.85/1.3 μm
	MN9605C					√												1.31/1.55 μm
	MN95D					√												1.3 μm
	MN924C					√												1.3/1.55 μm
Programmable optical attenuator	MN9625A/9626A					√												1.2 to 1.65 μm
Waveform monitors	MP9653A/9654A/9655A												√					1.31/1.55 μm
Optical channel selectors	MN9662A/9664A/9672A/9674A																√	1.2 to 1.65 μm
E/O, O/E converter	MP9677B												√	√				10G optical jitter solution
Optical directional coupler	MN9604C									√							√	1.25 to 1.60 μm
Bare fiber connectors	MP922B																√	
Fiber adapter	MA9013A																√	
Optical accessories	Optical fiber cord, adapter, dummy fiber, optical fiber cutter, jacket stripper, mode scrambler																√	

Optical connector options for Anritsu optical measuring instruments

A variety of optical connectors are used with optical fibers worldwide. Specify the option number, model name, and number of the optical connector from the table below according to the type of optical connector you use. If no specification is made, an FC-type connector will be supplied.

For combinations marked with “√” symbols in the table, the required instrument can be supplied according to the order. For connectors without “√” symbols or which do not appear in the table, consult your sales representative. For measuring equipment with more than one

control panel, specify only the connector connected to the measured fiber. Be sure to consult us before ordering, particularly for optical connectors for single-mode fibers, to avoid trouble with connectors not fitting.

Optical connectors may be designed for either flat-polished or PC-polished ends. Some measuring instruments use connectors only for PC-polished ends; consult the literature on the instrument before specifying the connector option.

Model		Connector option number																	
		21	22	23	25	26	27	31	34	35	37	38	39	40	41	42	43	45	47
		NEC D4	AT & T Biconical*1	Amphenol 906*2	FC-APC*3	SC-APC*3	E-2000*1	EC*3	Diamond*4	Amphenol 905	FC-PC*1	ST	DIN 47256	SC	TOCP 172*2	HFS-13/A (Gj)*2	HMS-10/A (SM)*1	FC	HRL-10 (APC)*3
Light source units (for MG9001A and MG9002A)	MG0914E	✓	✓						✓		✓	✓	✓	✓				✓	
	MG0917A/B	✓	✓						✓		✓	✓	✓	✓				✓	
	MG0917D	✓									✓	✓	✓	✓			✓	✓	
	MG0918B	✓	✓						✓		✓	✓	✓	✓				✓	
	MG0918D	✓									✓	✓	✓	✓			✓	✓	
	MG0927D/J	✓									✓	✓	✓	✓			✓	✓	
	MG0928D/J	✓									✓	✓	✓	✓			✓	✓	
Tunable laser source	MG9541A						✓	✓			✓*5	✓*5	✓*5	✓*5			✓*5		
SLD light source	MG9587A										✓	✓	✓	✓			✓		
LED sources (for MS9020D)	MS0901A	✓	✓	✓					✓	✓	✓	✓	✓	✓	✓	✓	✓	✓	✓
	MS0902A	✓	✓	✓					✓	✓	✓	✓	✓	✓	✓	✓	✓	✓	✓
	MS0903A	✓	✓	✓					✓	✓	✓	✓	✓	✓	✓	✓	✓	✓	✓
	MS0904A	✓	✓	✓					✓	✓	✓	✓	✓	✓	✓	✓	✓	✓	✓
	MS0904B										✓		✓	✓				✓	
	MS0905A									✓	✓			✓	✓			✓	
	MS0906A	✓	✓	✓					✓	✓	✓	✓	✓	✓	✓	✓	✓	✓	✓
LD sources (for MS9020D)	MS0902D										✓			✓				✓	
	MS0903D										✓			✓				✓	
	MS0908A										✓*5	✓*5	✓*5	✓*5			✓*5		
	MS0909A										✓*5	✓*5	✓*5	✓*5			✓*5		
Optical power sensors (for ML910B)	MA9301A	✓	✓							✓	✓	✓	✓	✓				✓	
	MA9302A	✓	✓	✓					✓		✓	✓	✓	✓	✓		✓	✓	
	MA9305B	✓	✓	✓							✓	✓	✓	✓				✓	
	MA9307A										✓	✓						✓	
	MA9801A	✓	✓								✓	✓	✓					✓	
	MA9802A	✓	✓	✓					✓		✓	✓	✓	✓	✓			✓	✓
	MA9807A										✓	✓							
Optical power sensors (for ML9002A and MS9020D)	MA9421A	✓	✓	✓					✓	✓	✓	✓	✓	✓	✓	✓	✓	✓	✓
	MA9423A	✓	✓	✓					✓	✓	✓	✓	✓	✓	✓	✓	✓	✓	✓
	MA9621A	✓	✓	✓					✓	✓	✓	✓	✓	✓			✓	✓	✓
	MA9721A	✓	✓	✓					✓	✓	✓	✓	✓	✓			✓	✓	✓
	MA9723A	✓	✓	✓					✓	✓	✓	✓	✓	✓			✓	✓	✓
Optical power sensors (for ML9001A)	MA9411A	✓	✓	✓					✓	✓	✓	✓	✓	✓	✓	✓	✓	✓	✓
	MA9412A	✓	✓								✓	✓	✓	✓			✓	✓	✓
	MA9611A	✓	✓	✓					✓	✓	✓	✓	✓	✓			✓	✓	✓
	MA9612A	✓	✓								✓	✓	✓	✓			✓	✓	✓
	MA9711A	✓	✓	✓					✓	✓	✓	✓	✓	✓	✓	✓	✓	✓	✓
	MA9712A	✓	✓	✓					✓	✓	✓	✓	✓	✓	✓	✓	✓	✓	✓
	MA9714B										✓*5	✓*5	✓*5	✓*5			✓*5		
Optical power sensors (for MS9020D)	MA9622A										✓*5	✓*5	✓*5	✓*5			✓*5		
Optical return loss measuring unit	MS0907A (for MS9020D)										✓	✓*1	✓*1	✓*1			✓		
Optical test set	MT9810A										✓*5	✓*5	✓*5	✓*5			✓*5		
Multi channel box	MT9812B										✓*5	✓*5	✓*5	✓*5			✓*5		
Adapter	MP92B	✓	✓	✓					✓	✓	✓	✓	✓	✓	✓		✓	✓	
	MA9013A	✓										✓	✓	✓			✓	✓	
	MA9001B	✓	✓	✓					✓	✓	✓	✓	✓	✓	✓	✓	✓	✓	✓

Continued on next page

Model		Connector option number																	
		21	22	23	25	26	27	31	34	35	37	38	39	40	41	42	43	45	47
		NEC D4	AT & T Biconical*1	Amphenol 906*2	FC-APC*3	SC-APC*3	E-2000*1	EC*3	Diamond*4	Amphenol 905	FC-PC*1	ST	DIN 47256	SC	TOCP 172*2	HFS-13/A (Gj)*2	HMS-10/A (SM)*1	FC	HRL-10 (APC)*3
Optical wavelength/frequency counter	MF9630A	√	√						√		√	√	√	√			√	√	
Optical spectrum analyzer	MS9710B				√	√	√	√			√*5	√*5	√*5	√*5			√*5		√
	MS9710C				√	√	√	√			√*5	√*5	√*5	√*5			√*5		√
	MS9780A						√				√*5	√*5	√*5	√*5			√*5		
WDM network tester	MS9720A					√				√*5	√*5	√*5	√*5			√*5		√	
WDM tester	MS9715A					√	√				√*5	√*5	√*5	√*5			√*5		
Optical amplifier test system	ME7890B										√*5	√*5	√*5	√*5			√*5		
Optical time domain reflectometer	MW9060A	MW0945B	√	√					√			√	√	√			√	√	
		MW0947B	√	√					√			√	√	√			√	√	
		MW0944B	√*5	√					√*5		√	√*5	√*5	√*5			√		√
		MW0967B	√	√	√				√			√	√	√		√		√	
	MW9076 series				√	√					√	√	√	√			√		
Waveform monitors	MP9653A																		√
	MP9654A																		√
	MP9655A/B										√*5	√*5	√*5	√*5			√*5		
Optical attenuators	MN95D	√	√						√		√	√	√	√		√			√
	MN924C	√	√						√		√*6	√*6	√*6	√*6			√	√*6	
	MN9605C										√*5	√*5	√*5	√*5			√*5		
	MN938A	√	√						√		√	√	√	√		√		√	
Programmable optical attenuator	MN9625A/9626A				√						√	√	√	√			√	√	
Optical channel selectors	MN9662A/9664A/9672A/9674A										√*5	√*5	√*5	√*5			√*5		√
E/O, O/E converter	MP9677B											√	√	√			√		
Optical directional coupler	MN9604C										√		√						
Optical fiber cord for baseband measurements		√																	√
Dummy fiber cord for optical loss measurements		√									√								√
Mode scrambler	MZ106C										√			√					√

- *1: Ferrule type; PC
- *2: Ferrule type; Flat
- *3: Ferrule type; APC (angled PC)
- *4: Ferrule diameter; 3.5 mm, M9 x 0.5 screw
- *5: Ferrule type; PC (user replaceable and cleanable)
- *6: Ferrule type; Flat (user replaceable and cleanable)

No marking: Ferrule type; Flat and PC.

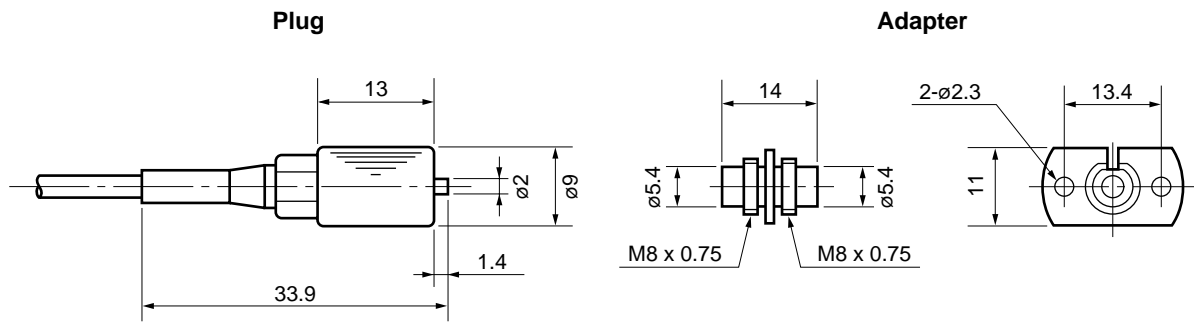
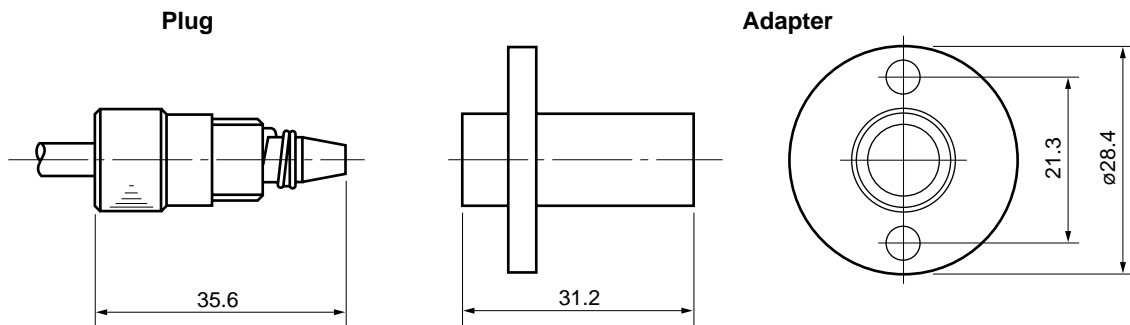
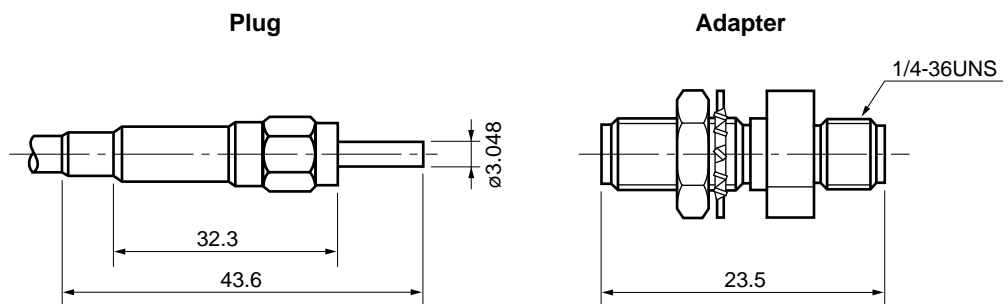
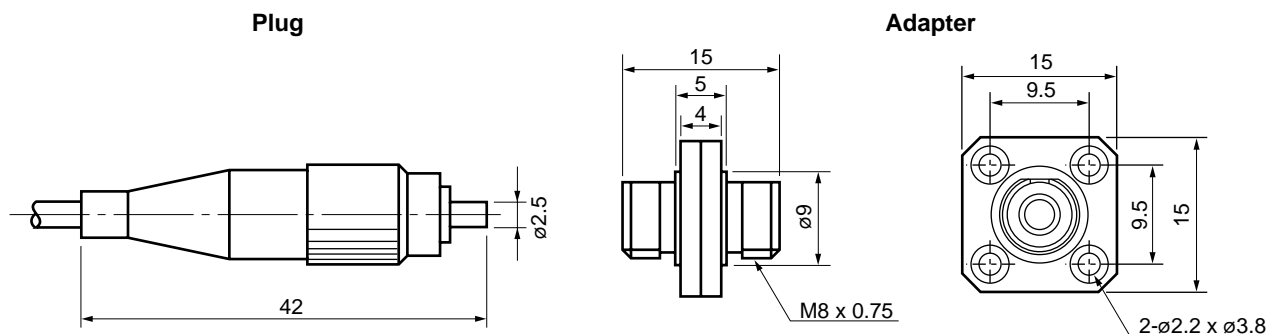
Option 21: Type D4 connector (flat, convex: PC)

Option 22: AT&T Biconical connector (convex: PC)

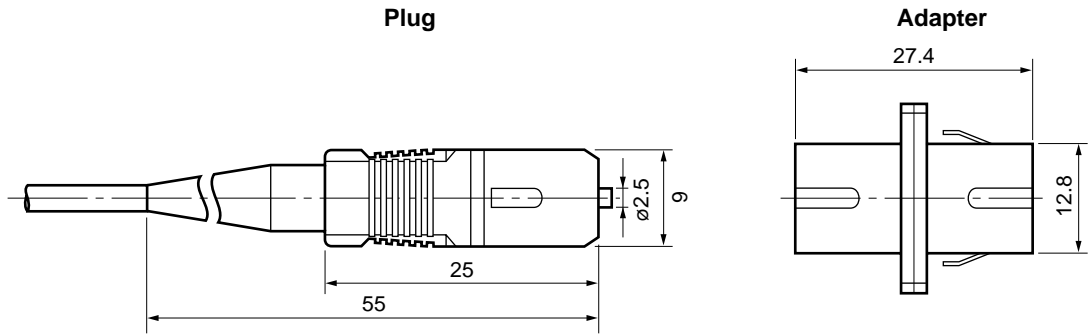
Option 23: Amphenol type 906 connector (flat)

**Option 25: FC-APC (angled convex), Option 37: FC-PC (convex)
Option 45: FC (flat)**

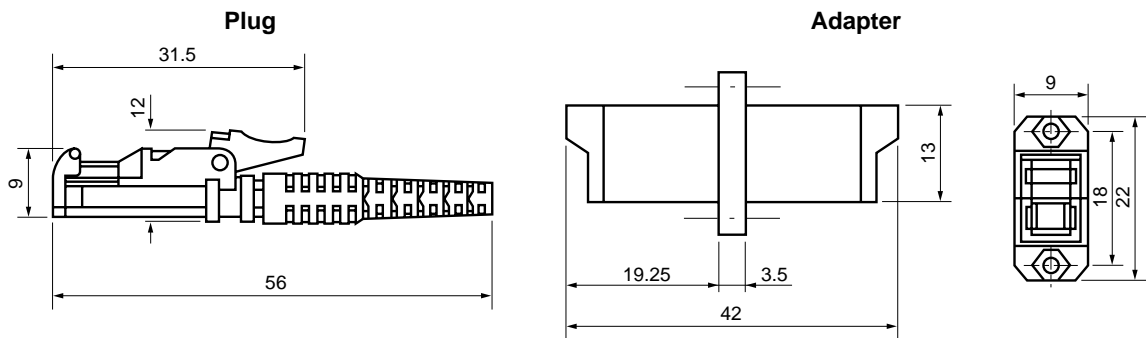
Option 26: SC-APC (angled convex)
 Option 40: SC connector (flat, convex: PC)



Option 27: E-2000 (convex: PC, angled convex: APC)



Option 31: EC (angled convex: APC)

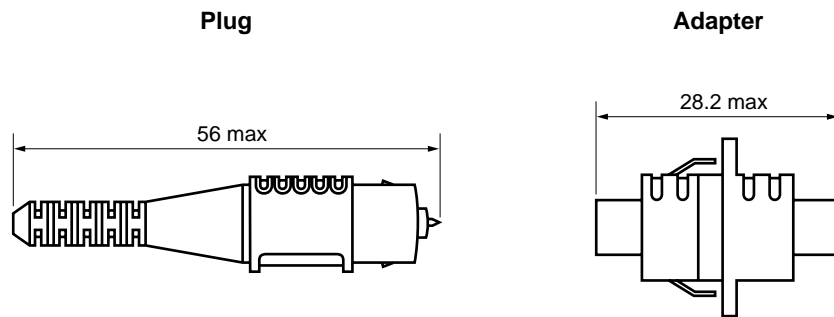

Option 34: Diamond connector
 GI: HFS-3 (flat)
 SM: HMS-0 (convex: PC)

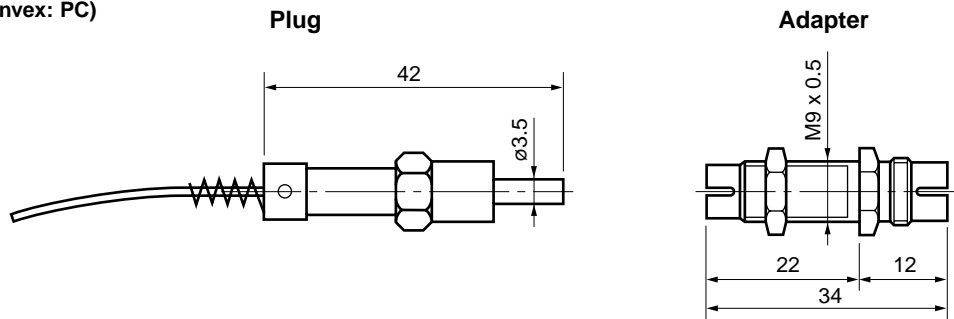

Option 35: Amphenol type 905 connector, HP SMA connector
 Amphenol type 905: Flat
 HP SMA: Convex (PC)

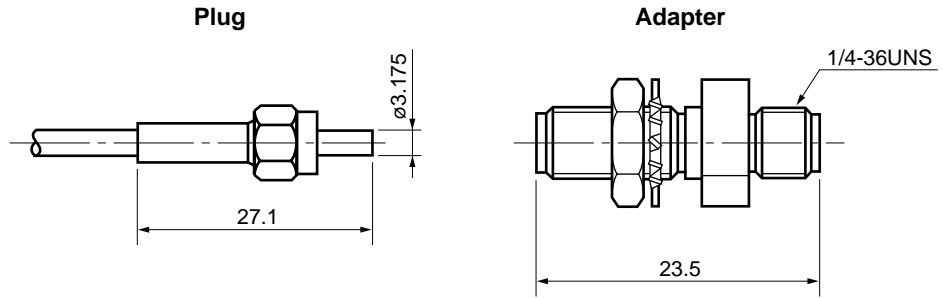

Option 38: ST connector (flat, convex: PC)

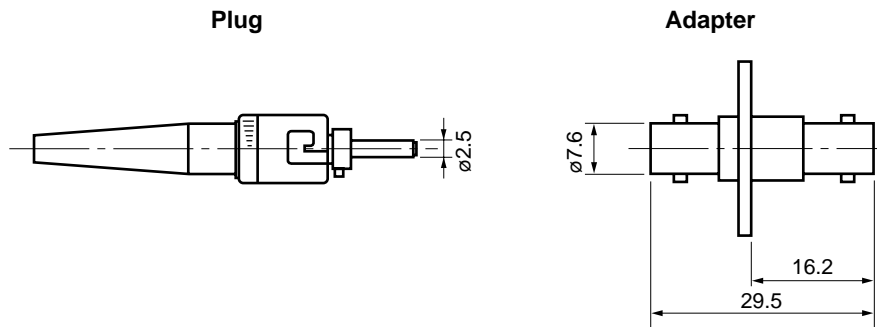

Option 39: DIN connector (flat, convex: PC)
Option 47: HRL-10 (angled convex)

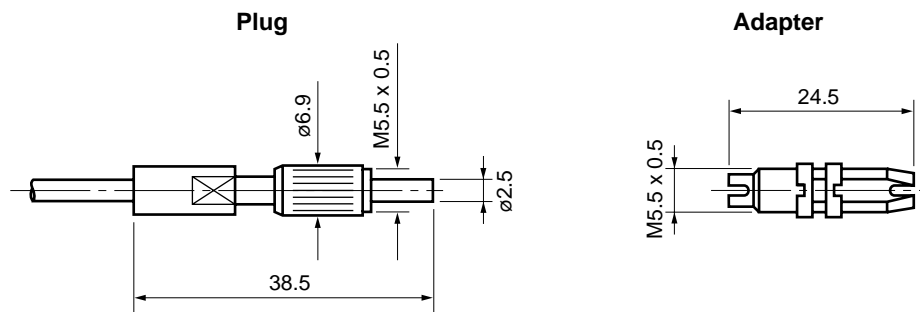

Option 41: TOCP 172 (flat)

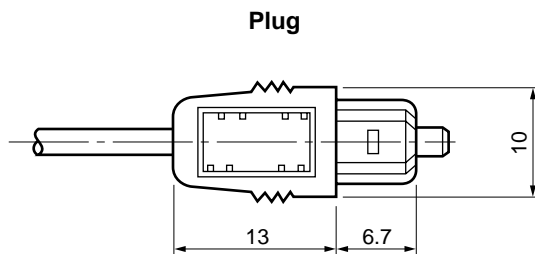

Option 42: HFS-13/A (GI, flat)

Plug

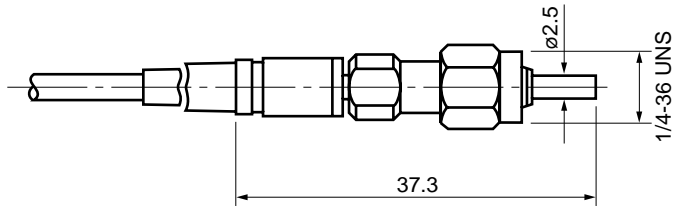

Adapter

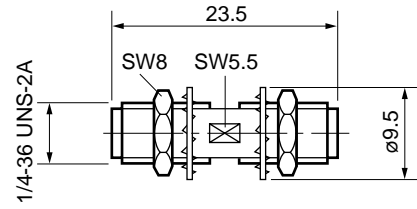

Option 43: HMS-10/A (SM, convex: PC)

Plug

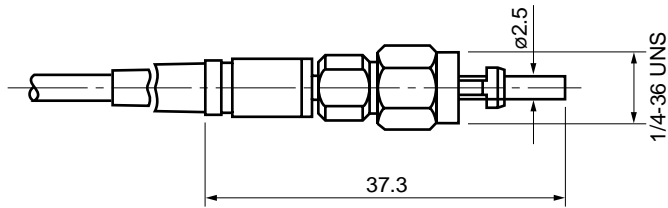

Adapter

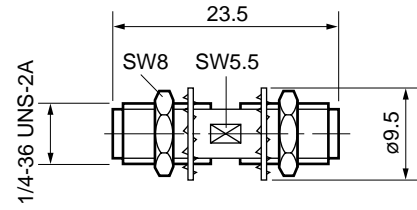

TUNABLE LASER SOURCE
MG9541A
 1510 to 1640 nm

For Evaluating Characteristics of WDM Transmission Systems and Optical Components

NEW



CE GPIB

The MG9541A covers the wavelength band from 1510 to 1640 nm with three outputs — a variable optical level output, a high power output and a high signal-to-noise ratio output. The MG9541A supports a wide variety of applications including optical amplifier evaluation systems and evaluation of characteristics of optical components used in WDM transmission systems.

Features

• **Full coverage of C and L bands**

The wavelength range is 1510 to 1640 nm, offering ideal support for the C-band (1530 to 1565 nm) and L-band (1565 to 1625 nm) wavelengths used in WDM communications, and for evaluating the performance of optical components and transmission systems.

• **Variable level of -30 to 0 dBm (1st port)**

An internal optical attenuator provides a high-stability optical output over a variable level range of -30 to 0 dBm, offering an effective solution for evaluation of component performance versus input level, such as optical amplifiers.

• **High power (+7 dBm) output (2nd port)**

The optical power is better than +7 dBm in the wavelength range from 1530 to 1580 nm, and better than +6 dBm in the C to L bands. In addition to use as an optical saturation signal for optical amplifier systems, this output also supports saturation tests of optical amplifiers and WDM transmission systems.

• **ITU-T grid wavelength setting functions**

The grid wavelength used in WDM communications (ITU-T SG15) is easy to set, and a user grid wavelength can also be set because any wavelength can be registered.

• **External control via built-in Ethernet**

In addition to built-in support for GPIB and RS-232C, an Ethernet interface (10BASE-T/100BASE-TX) is provided as standard equipment, offering external control via a network.

• **High signal-to-noise ratio (approx. 70 dB) optical output (3rd port)**

This port has a signal-to-noise ratio of approx. 70 dB. As shown in the spectrum waveform, the source spontaneous emission (SSE) generated by the MG9541A itself is lower than the detection limit of the measuring instrument. When combined with a high-sensitivity power meter, it can be used to measure the performance of passive optical components, such as optical filters, optical isolators, optical couplers, etc.

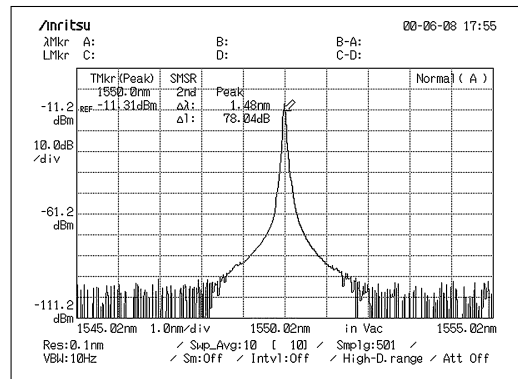

Example of high signal-to-noise ratio spectrum

Specifications

Optical output port*1	1st output (variable level over wide range)	2nd output (high-power)	3rd output (high signal-to-noise ratio)
Wavelength range	1510 to 1640 nm (>130 nm)		
Wavelength setting resolution	1 pm		
Absolute wavelength accuracy	±55 pm (valid for 10 h after wavelength calibration and at constant temperature)		
Relative wavelength accuracy	±45 pm (constant temperature)		
Wavelength repeatability	±35 pm (constant temperature)		
Wavelength stability	±8 pm (approx. 1000 MHz, 0 to 10 min after changed the parameter, constant temperature) ±0.8 pm (approx. 100 MHz, 10 min to 1 h after changed the parameter, constant temperature)		
Maximum output power	≥+1 dBm (1530 to 1580 nm) ≥0 dBm (1530 to 1625 nm) ≥-2 dBm (1510 to 1640 nm)	≥+7 dBm (1530 to 1580 nm) ≥+6 dBm (1530 to 1625 nm) ≥+4 dBm (1510 to 1640 nm)	≥-15 dBm (1530 to 1625 nm) ≥-20 dBm (1510 to 1640 nm)
Minimum output power	≤-30 dBm (1510 to 1640 nm)	2 dB down from the maximum output power (1510 to 1640 nm)	≤-30 dBm (1510 to 1640 nm)
Power linearity	±0.30 dB (constant temperature)	±0.60 dB (constant temperature)	±0.3 dB (constant temperature)
Power repeatability	±0.02 dB (≥-20 dBm, constant temperature) ±0.04 dB (<-20 dBm, constant temperature)	±0.22 dB (constant temperature)	±0.02 dB (≥-20 dBm, constant temperature) ±0.04 dB (<-20 dBm, constant temperature)
Power stability	±0.01 dB (≥-20 dBm, 1 h, constant temperature)*2 ±0.02 dB (<-20 dBm, 1 h, constant temperature)*2	±0.20 dB (0 to 10 min after changing setting, constant temperature) ±0.05 dB (10 min. to 1 h after changing setting, constant temperature)	±0.01 dB (≥-20 dBm, 1 h, constant temperature)*2 ±0.02 dB (<-20 dBm, 1 h, constant temperature)*2
Level flatness	±0.30 dB (constant temperature)	±0.60 dB (1530 to 1580 nm, 1570 to 1625 nm, constant temperature)	±0.30 dB (constant temperature)
Signal-to-noise ratio	≥47 dB/0.1 nm (1530 to 1620 nm) ≥40 dB/0.1 nm (1520 to 1620 nm) ≥37 dB/0.1 nm (typical, 1510 to 1640 nm)	≥47 dB/0.1 nm (1530 to 1620 nm) ≥40 dB/0.1 nm (1520 to 1620 nm) ≥37 dB/0.1 nm (typical, 1510 to 1640 nm) *At maximum output	≥69 dB/0.1 nm (1520 to 1620 nm) ≥66 dB/0.1 nm (typical, 1510 to 1640 nm)
Spectrum line width	Coherence control off: ≤800 kHz (typical), Coherence control on: ≥10 MHz (typical)		
Polarization extinction ratio	≥15 dB (typical, when FC-PANDA or SC connector is used and Anritsu specified polarization-maintaining optical fiber is used.)		
Tuning speed	<2200 ms/100 nm, <1200 ms /10 nm, <1200 ms /1 nm		
Power	85 to 132 Vac/170 to 250 Vac, 47.5 to 63 Hz, <190 VA		
Warming-up time	<1 h (power on at room temperature)		
Temperature range	+10° to +35°C (operating), -20° to +60°C (storage)		
Dimensions and mass	320 (W) x 133 (H) x 451 (D) mm, ≤16.5 kg		
EMC	EN61326: 1997/A1: 1998 (Class A), EN61000-3-2: 1995/A2: 1998 (Class A), EN61326: 1997/A1: 1998 (Annex A)		
LVD	EN61010-1: 1993/A2: 1995 (Installation category II, Pollution degree 2)		
Laser safety	IEC-60825-1: Class 3B, FDA (21CFR1040.10): Class III b		

*1: The specifications for 3 kinds of optical output ports are applied for the selected one port.

*2: When the supplied terminator is connected to the 2nd output.

Safety measures for laser products

MG9541A complies with optical safety standards of the IEC pub. 6082 5-1 and the FDA (21CFR1040.10, USA). The following descriptive labels are affixed to the product.



21CFR1040-10, label

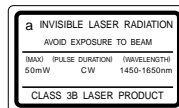

IEE-60825-1, label

Ordering information

Please specify model/order number, item, and quantity when ordering.

Model/Order No.	Name
MG9541A	Main frame Tunable Laser Source
	Standard accessories
	Power cord, 2.6 m : 1 pc
	Optical connector*1: 3 pcs
F0013	Fuse, 5 A: 2 pcs
W1814AE	MG9541A operation manual: 1 pc
W1815AE	MG9541A remote control operation manual: 1 pc
S0003	Optical output control key: 2 pcs
B0329F	Front cover (3/4MW3U): 1 pc
J1076	Terminator: 1 pc
	Peripheral instruments
MS9710B	Optical Spectrum Analyzer
MS9710C	Optical Spectrum Analyzer
	Application parts
Z0282	Ferrule cleaner
Z0283	Replacement reel for ferrule cleaner (6 pcs/set, for Z0282)
Z0284	Cleaner for optical adapter (stick type, 200 pcs/set)
J1082	FC · PC-FC · PC-1M-PM13 (FC · PC polarization-maintaining optical fiber cord, 1 m)
J1083	FC · PC-SC · PC-1M-PM13 (FC · PC-SC · PC conversion polarization-maintaining optical fiber cord, 1 m)
J1084	SC · PC-SC · PC-1M-PM13 (SC · PC polarization-maintaining optical fiber cord, 1 m)
J0575	FC · PC-FC · PC-2M-SM (FC · PC optical fiber cord, SM, 2 m)
J0006	GPIB cable, 0.5 m
J0007	GPIB cable, 1 m
J0008	GPIB cable, 2 m
J0009	GPIB cable, 4 m
J0654A	Serial interface cable
J0655A	Serial interface cable
J0739G	Replaceable optical connector (FC-PANDA)
J0618D	Replaceable optical connector (ST)
J0618E	Replaceable optical connector (DIN)
J0618F	Replaceable optical connector (HMS-10/A)
J0619B	Replaceable optical connector (SC)
B0498	Rack mount kit
	Options
MG9541A-29	Tunable laser source (with FC-PANDA connector)*1
MG9541A-38	Tunable laser source (with ST connector)*1
MG9541A-39	Tunable laser source (with DIN connector)*1
MG9541A-40	Tunable laser source (with SC connector)*1
MG9541A-43	Tunable laser source (with HMS-10/A connector)*1

*1: When ordering, the option-specified connector is supplied as standard. Specify the option number after the model name. If a connector is not specified, a FC-PANDA connector (Option 29) is supplied as standard.

OPTICAL COMPONENT TESTER
ME7894A

For Evaluating Passive Optical Devices such as WDM and Fiber Amplifiers

NEW



The ME7894A is used in conjunction with the MG9541A Tunable Laser Source, the MT9810B Optical Test Set and the MA9332A Optical Sensor to configure a high-speed measurement system for optical components (filters, couplers, isolators, etc.) used in WDM transmission systems. The measurement can be easily set up over a wide wavelength range from C-band (1530 to 1565 nm) to L-band (1565 to 1625 nm).

Functions

• **C- and L-bands (1510 to 1640 nm)**

The ME7894A has a signal-to-noise ratio of approx. 70 dB over a wide wavelength range from the C-band (1530 to 1565 nm) to the L-band (1565 to 1625 nm) using the 3rd port of the MG9541A Tunable Laser Source. It is ideal for measuring the wavelength characteristics of WDM optical components.

• **High-speed measurement**

Combining the ME7894A with the MA9332A Optical Sensor makes high-speed measurement possible. For example, 5001 data points can be measured in less than 10 seconds. (wavelength sweep range: 20 nm, span: 4 pm, bandwidth: Auto)

• **High dynamic range**

A measurement range of more than 50 dB is achieved from 1530 to 1625 nm (C-and L-bands) by using the high-signal-to-noise ratio (approx. 70 dB) optical output (3rd port) and high sensitive sensor.

• **2-channel automatic measurement**

Measurement conditions can be input directly into the settings screen displayed on a PC. The ME7894A can measure up to two sensor channels automatically and display the results as a graph.

• **Bare fiber support**

A bare fiber can be connected to the MA9332A Optical Sensor, greatly reducing the inspection time on optical component production lines, etc., and increasing the work efficiency. Moreover, measurement is possible using only the MA9332A with no need to move main power meter.

MX789400A Optical Component Tester Control Software

When the MX789400A software is installed in a PC, the MG9541A and MT9810B can be controlled via the GPIB. The software has functions to calculate the data before and after the DUT is inserted, measure the DUT loss wavelength characteristics, and display the results graphically. It makes evaluation of components easier and the measured data can be saved as a text file for importing into spreadsheet applications, etc.

Versatile control functions

The MX789400A*1 has both detailed setting functions and ActiveX*2 for required control. The software manages timing during tracking measurement with the MG9541A and MT9810B. By using Visual Basic*2, etc., it is possible to create powerful software applications for the required evaluation.

*1: For the performance of recommended PC, refer to the note *5 in page 49.

*2: Registered trademark of Microsoft Corporation

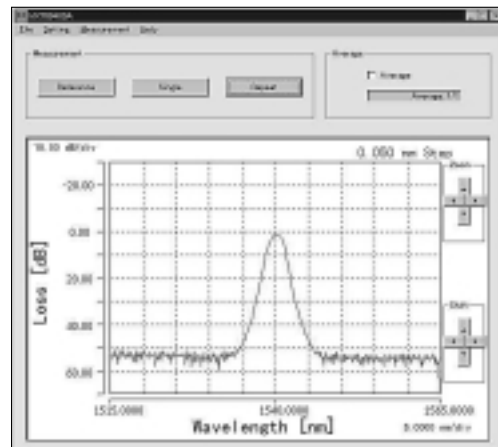

Optical filter measurement example

Applications

• Measuring wavelength characteristics of optical coupler

The signal-to-noise ratio of the optical output of 3rd port of the MG9541A is 70 dB (typ.). When this high-signal-to-noise ratio optical signal is input to an optical coupler, the wavelength characteristics of the branch ratio can be measured by the MT9810B and the results displayed as a graph on a PC.

• Multiple light sources

The characteristics of optical components can be checked efficiently by branching the high-power optical output (2nd port) of the MG9541A. For example, several test-stations can use one MG9541A by branching the high-power output.

• Measuring wavelength characteristics of fiber bragg grating

When the high-signal-to-noise ratio optical output of 3rd port of the MG9541A is input to a fiber Bragg grating, the MT9810B can measure the transmitted and reflected light. The measurement results are displayed graphically on a PC.

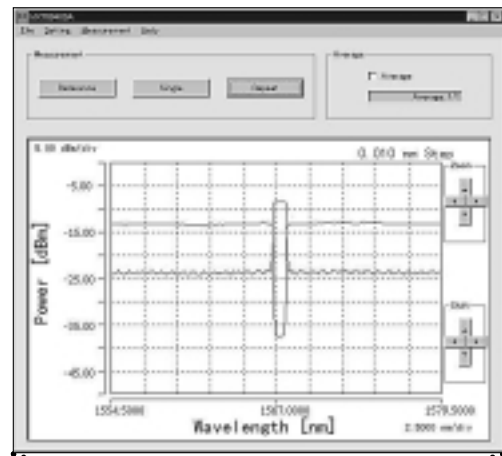

FBG measurement example

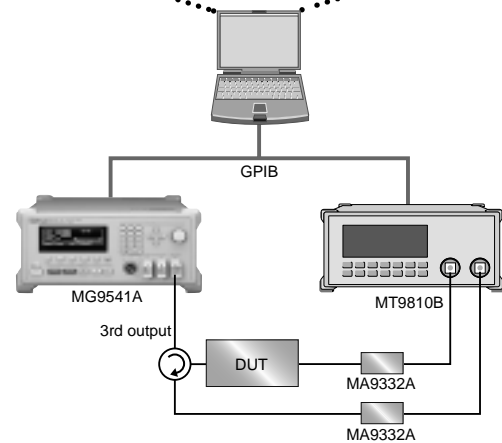

Specifications

• ME7894A Optical Component Tester

Configuration instruments	MG9541A, MT9810B, MU931002A, MA9332A
Wavelength measurement range	1510 to 1640 nm
Minimum wavelength resolution	1 pm
Absolute wavelength accuracy*1	±55 pm
Wavelength repeatability*2	±35 pm
Loss measurement dynamic range	≥50 dB (1530 to 1625 nm)
Loss measurement accuracy	≤±0.3 dB (-10 dBm)
Loss measurement linearity*3	≤±0.1 dB ±5 nW (-10 to -50 dBm)
Loss measurement repeatability	≤±0.1 dB ±5 nW (-10 to -49 dBm)
SNR*4	≥69 dB/0.1 nm (MG9541A 3rd output)
Measurement time	≤10 s (wavelength span: 20 nm, wavelength resolution: 4 pm, using 1 channel)
Number of channels	Max. 2 channels
Operating temperature	+10° to +35 °C
Software*5	MX789400A Optical Component Tester Control Software
EMC	EN61326: 1997/A1: 1998 (Class A), EN61000-3-2: 1995/A2: 1998 (Class A), EN61326: 1997/A1: 1998 (Annex A)
LVD	EN61010-1: 1993/A2: 1995 (Installation Category II, Pollution degree 2)

*1: After wavelength calibration, <10 h, constant temperature

*2: Constant temperature

*3: -10 dBm reference

*4: Signal-to-noise ratio

*5: PC required for MX789400A

IBM-PC AT compatible with CPU equivalent of Intel Celeron 450 MHz or higher (with FPU), 64 Mbytes of RAM min., 100 Mbytes or more of free disk space, 1024 x 768 pixel min. display, running Microsoft Windows 95 service pack 1 or later, or Windows 98 and Microsoft Internet Explorer V.4.01 or later, with National Instrument PCI-GPIB or PCMCIA-GPIB installed

Microsoft Windows and Internet Explorer are registered trademarks of Microsoft Corporation in the USA and other countries. Other company names and trademarks in this catalog are the property of their respective owners.

• MG9541A Tunable Laser Source

For the specifications, refer to page 46.

• MT9810B Optical Test Set

Display resolution	dBm: 0.001, 0.01, 0.1 dB: 0.001, 0.01, 0.1 Watt: 5 digits
Display range	-199.999 to +199.999 dBm, ± 0.0001 pW to ± 10000 W
Display	Fluorescent character display tube
Remote control	GPIO, RS-232C
External trigger input connector	BNC type (MG9541A dedicated)
Laser safety mechanism	Remote interlock, optical output control (key control)
Environmental conditions	Operating temperature and humidity: 0° to +50°C/ $\leq 90\%$ (no condensation), Storage temperature: -25° to +71°C
Plug-in units	Max. 2
Dimensions and mass	213(W) x 88(H) x 351(D) mm, ≤ 3.5 kg (excluding plug-in units)
Power	85 to 132 Vac/170 to 250 Vac, 47.5 to 63 Hz, ≤ 70 VA
EMC	EN61326: 1997/A1: 1998 (Class A), EN61000-3-2: 1995/A2: 1998 (Class A), EN61326: 1997/A1: 1998 (Annex A)
LVD	EN61010-1: 1993/A2: 1995 (Installation Category II, Pollution degree 2)

• MA9332A Optical Sensor

This specifications are available combined with MT9810B Optical Test Set.

Element	InGaAs-PD
Input type	Fiber (with using MA9005A connector adapter)
Applicable optical fiber	9/125 to 62.5/125 mm (NA: ≤ 0.29)
Wavelength range	750 to 1700 nm
Optical power measurement range*1	+5 to -80 dBm (continuous light)
Noise level*2	≤ -76 dBm
Polarization dependency*3	$\leq \pm 0.017$ dB (typ: $\leq \pm 0.01$ dB)
Optical power measurement uncertainty*4	Reference conditions: $\pm 2\%$, operating conditions: $\pm 3.5\%$
Linearity*5	$\leq \pm 0.05$ dB ± 50 pW (+7 to 0 dBm), $\leq \pm 0.01$ dB ± 30 pW (0 to -70 dBm)
Optical connector*6	FC-PC, ST, DIN, HMS-10/A, SC
Environmental conditions	Operating temperature and humidity: 0° to +50°C/ $\leq 90\%$ (no condensation) Storage temperature: -40° to +71°C
Dimensions and mass	45 (W) x 60 (H) x 110 (D) mm, ≤ 500 g
Connection with MT9810B	Requires MU931002A

*1: 1550 nm

*2: Peak-to-peak noise, measurement interval: 100 ms, averaging: 10 times, 1550 nm

*3: Using SM fiber (ITU-T G.652), return loss: ≥ 45 dB, 1550 nm

*4: Reference conditions

SM fiber (ITU-T G.652), master FC connector, power level: 100 μ W (-10 dBm), continuous light, 1550 nm, 23° $\pm 2^\circ$ C, at day of calibration, after 30 min warm-up

Operating conditions

SM fiber (ITU-T G.652), master FC connector, power level: 100 μ W (-10 dBm), continuous light, any wavelength in 1000 to 1650 nm range, 23° $\pm 5^\circ$ C, within 1 year after calibration, after 30 min warm-up, add 1% to accuracy for a fiber other than SM fiber (ITU-T G.652)

*5: Measurement conditions

Constant temperature within 23° $\pm 5^\circ$ C, bandwidth: auto/0.1 Hz/1 Hz/10 Hz, any wavelength in 1000 to 1650 nm, continuous light, power level: 100 μ W (-10 dBm) reference, after 30 min warm up

*6: Specify connector for optical connector option supplied as standard accessory. If connector not specified, FC-PC (Option 37) supplied as standard.

Ordering information

Please specify model/order number, name and quantity when ordering.

Model/Order No.	Name
MG9541A	Main frame Tunable Laser Source
	Standard accessories
	Power cord, 2.6 m : 1 pc
	Optical connector*1: 3 pcs
F0013	Fuse, 5 A: 2 pcs
W1814AE	MG9541A operation manual: 1 copy
W1815AE	MG9541A remote control operation manual: 1 copy
S0003	Optical output control key: 2 pcs
B0329F	Front cover (3/4MW3U): 1 pc
J1076	Optical terminator: 1 pc
	Peripheral instruments
MS9710B	Optical Spectrum Analyzer
MS9710C	Optical Spectrum Analyzer
	Application parts
Z0282	Ferrule cleaner
Z0283	Ferrule cleaner tape
Z0284	Adapter cleaner
J1082	FC · PC-FC · PC-1M-PM13 (FC · PC polarization-maintaining optical fiber cord, 1 m)
J1083	FC · PC-SC · PC-1M-PM13 (FC · PC-SC · PC polarization-maintaining optical fiber conversion cord, 1 m)
J1084	SC · PC-SC · PC-1M-PM13 (SC · PC polarization-maintaining optical fiber cord, 1 m)
J0575	FC · PC-FC · PC-2M-SM (FC · PC optical fiber cord, 2 m, SM)
J0006	GPIB cable, 0.5 m
J0007	GPIB cable, 1 m
J0008	GPIB cable, 2 m
J0009	GPIB cable, 4 m
J0654A	Serial interface cable (9P-9P)
J0655A	Serial interface cable (9P-25P)
J0739G	Replaceable optical connector (FC-PANDA)
J0618D	Replaceable optical connector (ST)
J0618E	Replaceable optical connector (DIN)
J0618F	Replaceable optical connector (HMS-10/A)
J0619B	Replaceable optical connector (SC)
B0498	Rack mount kit
	Options
MG9541A-29	Tunable laser source (FC-PANDA connector)
MG9541A-38	Tunable laser source (ST connector)
MG9541A-39	Tunable laser source (DIN connector)
MG9541A-40	Tunable laser source (SC connector)
MG9541A-43	Tunable laser source [HMS-10/A (DIAMOND) connector]
ME7894A	Main frame Optical Component Tester
	Configuration instruments
MG9541A	Tunable Laser Source: 1 unit
MT9810B	Optical Test Set: 1 unit
MU931002A	Sensor Adapter: 1 unit
MA9332A	Optical Sensor: 1 unit
	Standard accessories
J0008	GPIB cable, 2 m: 2 pcs
J0775D	Coaxial cable, 2 m: 1 pc
	Option
ME7894A-01	2 channel option (able to use two units of MU931002A or MA9332A simultaneously)

Model/Order No.	Name
MT9810B	Main frame Optical Test Set
	Standard accessories
W1886AE	MT9810B operation manual: 1 copy
W1887AE	MT9810B remote control operation manual: 1 copy
J0895	RCA short pin: 1 pc
J0896	RCA plug (for remote interlock): 1 pc
Z0391	Key (for optical output control): 1 pc
F0011	Fuse, 2 A: 2 pcs
	Power cord, 2.6 m: 1 pc
B0425	Blank panel: 1 pc
	Plug-in unit
MU931002A	Sensor Adapter
	Standard accessories
J1073A	Optical sensor connection cable, 1.5 m: 1 pc
MX789400A	Optical Component Tester Control Software (FD): 1 set
W1926AE	MX789400A operation manual: 1 copy
	Optical sensor head
MA9332A	Optical Sensor (MA9005A Connector Adapter standard equipment)*2
	Options
MA9332A-37	FC-PC connector
MA9332A-38	ST connector
MA9332A-39	DIN connector
MA9332A-40	SC connector
MA9332A-43	HMS-10/A connector
	Application parts
MA9005A-37	Connector adapter (FC-PC)
MA9005A-38	Connector adapter (ST)
MA9005A-39	Connector adapter (DIN)
MA9005A-40	Connector adapter (SC)
MA9005A-43	Connector adapter (HMS-10/A)

*1: Connector for specified options at ordering supplied as standard. Specify by appending number after model. If connector not specified, FC-PANDA (Option 29) supplied as standard.

*2: Connector for specified options at ordering supplied as standard. Specify by appending number after model. If connector not specified, FC-PC (Option 37) supplied as standard.

Note: For personal computer, please contact your nearest Anritsu representative.

SLD LIGHT SOURCE
MG9587A
 1450 to 1650 nm

For Measurement of Wavelength Transmission Characteristics and PMD



The MG9587A provides a stable source of light over a wide wavelength range of more than 200 nm. It incorporates highly accurate control of the Super Luminescence Diode source (SLD; Anritsu manufactured), realizing a high output level and stability. It has applications in the measurement of wavelength transmission characteristics, where a white light source might have insufficient output to provide adequate dynamic range. By combining the MG9587A with the MS9710B/C Optical Spectrum Analyzer (OSA), high-dynamic range transmission measurements become possible.

In addition, using the MG9587A combined with an Anritsu optical spectrum analyzer, it is possible to measure polarization mode dispersion (PMD) in optical fibre and other optical components. The method used is the Fixed Analyzer (FA) Method, allowing fast and easy PMD measurement. The MS9710B/C Optical Spectrum Analyzer comes with application software for PMD measurement as standard. The MG9587A can also be installed into the MS9710B/C (option 13/14 for the MS9710B/C).

Basic features

Figure 1 shows the typical output spectrum of the MG9587A. While its peak level is -40 dBm/nm or more, it outputs more than -60 dBm/nm over a total bandwidth of 200 nm. Combined with the MS9710B/C, the transmission measurement dynamic range is greater than 30 dB at the spectrum edges, and more than 50 dB at the peak wavelength.

Figure 2 shows the spectrum of the WDM band. It features a flat characteristic of approximately 1 dB level deviation in a wavelength range of 50 nm around 1550nm.

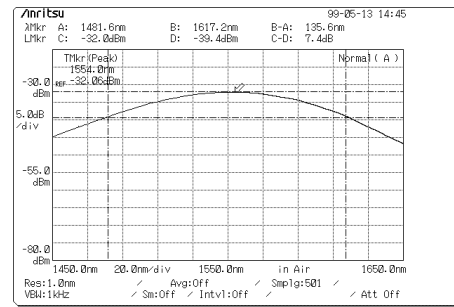

Fig. 1 Center wavelength: 1550 nm, Span width: 200 nm, RBW: 1 nm

Note: The measured level of the MG9587A depends on the Resolution Bandwidth (RBW) setting of the OSA. If the RBW is set to 0.5 nm on the OSA, then the measured level becomes 3 dB lower than when the RBW is set to 1 nm. It is for this reason that the SLD spectrum is always specified in power per unit nm (i.e., the power measured in an equivalent bandwidth of 1 nm).

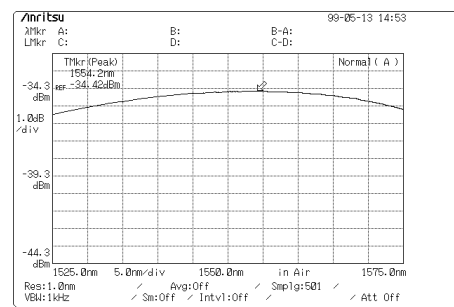

Fig. 2 Center wavelength: 1550 nm, Span width: 50 nm, RBW: 1 nm

Application

• Measurement examples of wavelength transmission characteristics

The following shows an example of Optical Band Pass Filter (OBPF) measurement.

Using the A trace of the optical spectrum analyzer, the spectrum is measured after being transmitted through a standard SM fiber patch cord. The measured value is assumed to be the reference level. Then the device under test (DUT) is connected, and the spectrum is measured and displayed on the B trace. By calculating the difference between these two spectra, the transmission characteristics of the DUT can be displayed. Anritsu optical spectrum analyzers feature a (B – A) function, that is able to normalize spectra so that the actual transmission characteristics of DUTs can be easily measured with high reproducibility.

Figure 3 shows the spectrum (B – A) trace after subtraction. The peak search feature of the optical spectrum analyzer reveals that the insertion loss of the OBPF is 1.99 dB. The analysis feature of the optical spectrum analyzer finds that the half bandwidth (FWHM) is 2.32 nm.

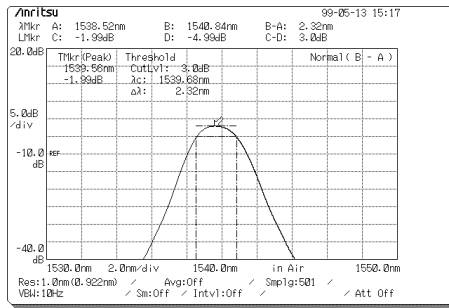
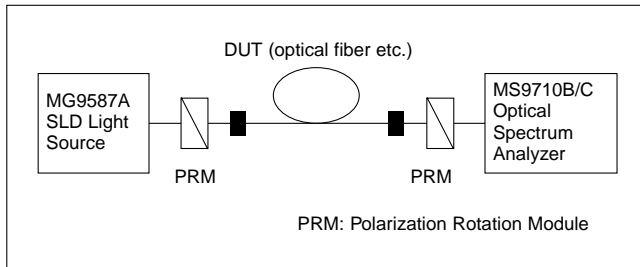

Fig. 3 Loss characteristics (B – A) trace

• PMD measurement example



• Measuring polarization mode dispersion

Polarization mode dispersion is one of the most important factors in determining the upper limit of an optical fiber system's transmission bit rate. There are many methods for measuring PMD, but all fall into 2 categories: time domain and frequency domain methods. The MS9710B/C is equipped with the Fixed Analyzer (FA) method, an automated frequency domain method employing wavelength scanning and extreme counting. The measured waveform is immediately processed to indicate the PMD value. Assuming that the 1st peak wavelength is λ_1 , the nth peak wavelength is λ_2 , and the difference between these two is $\Delta\lambda$ ($\lambda_2 - \lambda_1$), the MS9710B/C can automatically read each value and calculate the PMD by using the formula below:

$$PMD = \text{RMS DGD (Differential Group Delay)} = K \frac{N-1}{C} \times \frac{\lambda_1 \cdot \lambda_2}{\Delta\lambda}$$

K: Mode coupling factor, C: velocity of light (m/s),

N: number of counted peaks

Specifications

Wavelength range	1450 to 1650 nm
Output level	> -40 dBm/nm (1550 nm \pm 10 nm) > -60 dBm/nm (1450 to 1650 nm)
Output level stability*1	\pm 0.04 dB (MS9710B/C setting resolution: 1 nm, no polarization change, constant temperature, measured for 20 minutes at 1550 nm)
Spectrum half width	>70 nm (90 nm typical)
Optical connector	User replaceable type (FC, SC, ST, DIN, HMS-10/A)
Environmental condition	Operating temperature: 0° to +40°C, Storage temperature: -20° to +60°C, Relative humidity: <90%
Power	AC 85 to 132/170 to 250 V, 47.5 to 63 Hz, \leq 35 VA
Dimension and mass	213 (W) x 88 (H) x 250 (D) mm, \leq 3.5 kg *Excluding projections

*1: Measured after one hour warm-up

Ordering information

Please specify model/order number, name, and quantity when ordering.

Model/Order No.	Name
MG9587A	Main frame SLD Light Source
	Standard accessories
	Optical connector adapter*1: 1 pc
	Power cord, 2.5 m: 1 pc
F0011	Fuse, 2.0 A: 2 pcs
B0329L	Front cover: 1 pc
W1768AE	MG9587A operation manual: 1 copy
	Options
MG9587A-37	FC connector
MG9587A-38	ST connector
MG9587A-39	DIN connector
MG9587A-40	SC connector
MG9587A-43	HMS-10/A (DIAMOND) connector
	Application parts
J0617B	Replaceable optical connector (FC)
J0618D	Replaceable optical connector (ST)
J0618E	Replaceable optical connector (DIN)
J0618F	Replaceable optical connector (HMS-10/A)
J0619B	Replaceable optical connector (SC)
J0635B	Optical fiber patch-cord (FC · PC-FC · PC-2M-SM), 2 m
Z0282	Ferrule cleaner (A-type)
Z0283	Ferrule cleaner tape (for Z0282, 6 pcs/set)
Z0284	Adapter cleaner (stick-type, 200 pcs/set)
G0084	Polarization rotation module

*1: Please specify the connector to be supplied as the standard connector when ordering the above options. If the connector is not specified, an FC connector (MG9587A-37) will be supplied as standard.

STABILIZED LIGHT SOURCE
MG9001A/9002A
 0.85/1.3/1.55 μm

A Variety of Light Sources Units such as LED



MG9001A

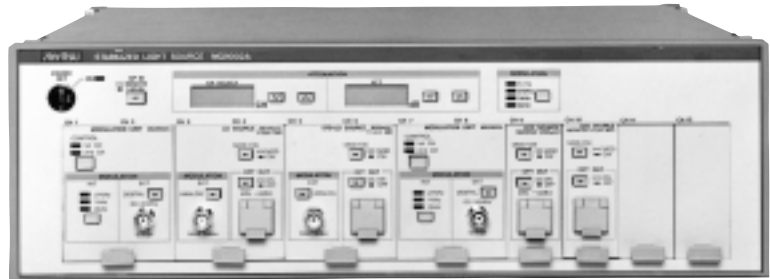

MG9002A



The MG9001A/9002A can be used as stabilized light sources for different applications by changing the light source units. In particular, they have been designed for a high output stability of 0.02 dB. The MG9001A can hold 2 LED light source units. The MG9002A can hold 12 LED light source units making it ideal for measurement of loss in multi-core fiber cables. Analog and digital modulation functions are also provided in both models, which means that they can be used as E/O converters.

Features

- **Plug-in unit light sources**
 Units can be changed according to the application to configure very economical measurement arrangements.
- **Integrated optical power meter**
 The MG9001A can be connected to the ML9001A Optical Power Meter to configure a high-performance optical loss test set.
- **Integrated loss measurement in multi-core fiber cables**
 Connecting the MG9002A and the ML9001A permits simultaneous loss measurement of 12 cores in multi-core fiber cable.
- **Various modulation functions**
 Analog and digital modulation functions enable use of these models as LAN-system measuring instruments and as E/O converters for measuring baseband characteristics. Note that to apply external digital modulation and internal modulation separately to the MG9002A, the MG0902A Modulation Unit must be used.
- **Variable optical output level**
 The optical output level can be varied in 0.01 dB steps up to 6 dB.
- **Wide operating temperature range** (−10° to 50°C)

Application

Easy combined multi-core fiber cable loss measurement

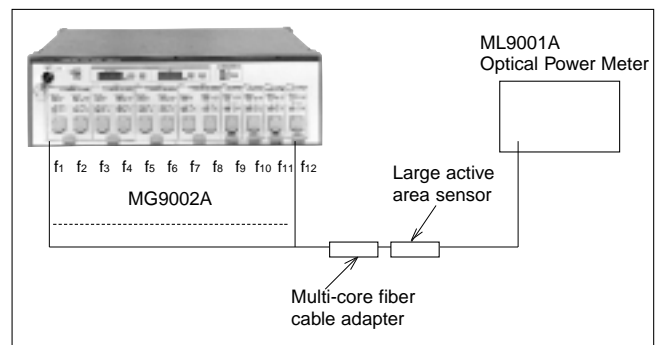

Note: f_1 to f_{12} : Individual modulation frequency
 Connecting the MG9002A to the ML9001A makes loss measurement in multi-core fiber cable easy with a single connection.

Specifications

• Main frames

Model	MG9001A	MG9002A
Number of units that can be installed	LED light source: 1 to 2 pcs	LED light source: 1 to 12 pcs
Attenuation display	0 to 6 dB, 0.01 dB steps	
Internal modulation	Frequencies: (270 kHz, 1 kHz, 2 kHz) $\pm 0.1\%$	Simultaneous modulation frequencies: (270 Hz, 1 kHz, 2 kHz) $\pm 0.1\%$ Individual modulation frequencies for each channel: Twelve range 170 to 1000 Hz
	Duty factor: 50 $\pm 10\%$ Output synchronized with modulation signal: TTL level (terminated at 10 k Ω), BNC	
External modulation	Frequency: DC to 30 MHz Input level: 0 to +0.8/+2 to +5 V Impedance: 75 Ω , BNC connector	See MG0902A Modulation Unit specification
GPIO	SH1, AH1, T8, L4, SR0, RL1, PP0, DC1, DT0, C0	
Temperature range	-10° to +50°C (spec. meet), -40° to +70°C (storage)	
Power	AC 100 V $^{+10}_{-15}\%$, 50/60/400 Hz, ≤ 49 VA (full units)	AC 100 V $^{+10}_{-15}\%$, 50/60 Hz, ≤ 200 VA (full units)
Dimensions and mass	213 (W) x 88 (H) x 251 (D) mm, ≤ 4 kg (without unit)	426 (W) x 133 (H) x 351 (D) mm, ≤ 12 kg (without unit)
EMC	EN61326: 1997/A1, 1998 (Class A) EN61000-3-2: 1995/A2, 1998 (Class D) EN61326: 1997/A1, 1998 (Annex A)	—
LVD	EN610101-1: 1993/A2, 1995 (Installation Category II, Pollution degree 2)	—

Explanation and warning label example

Maximum power output and wavelength are given for *1 and *2 respectively.

Explanation label (IEC)

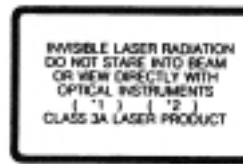

Warning label (CFR)



• LED Light Source Units

Model	MG0914E	MG0917A	MG0917B	MG0918B	MG0917D	MG0918D	MG0927D/J*1	MG0928D/J*1	
Compatible fiber	GI	GI/SM						SM	
Wavelength (μm)	0.85 ± 0.015 *2	1.3 ± 0.03 *2	1.31 ± 0.01	1.55 ± 0.01	1.31 ± 0.01	1.55 ± 0.01	1.31 ± 0.01	1.55 ± 0.01	
Spectral bandwidth	≤ 50 nm*2	≤ 130 nm*2	≤ 20 nm	≤ 25 nm	≤ 20 nm	≤ 25 nm	≤ 20 nm	≤ 25 nm	
Output*3	GI fiber	-13 ± 1 dBm	-20 ± 1 dBm	≥ -35 dBm			—		
	SM fiber	—	≥ -40 dBm	≥ -50 dBm			≥ -28 dBm	≥ -32 dBm	
Output level	Temperature characteristics	≤ 0.2 dB*4				≤ 0.1 dB*5	≤ 0.2 dB*6	≤ 0.2 dB*6(FC-PC)	≤ 0.5 dB*6(FC)
	Short term stability	≤ 0.02 dB*7						≤ 0.02 dB*7(FC-PC)	≤ 0.05 dB*7(FC)
Modulation	Internal digital modulation	Frequencies: (270 Hz, 1kHz, 2 kHz) $\pm 0.1\%$, individual modulation frequencies for each channel Duty factor: 50 $\pm 10\%$							
	External digital modulation	Input	Rise/fall time: ≤ 3 ns (10 to 90%), Level: 0 to +0.8/+2 to +5 V, Connector: BNC, Impedance: 75 Ω , Frequency: DC to 10 MHz				Output Rise/fall time: ≤ 10 ns		
	Output	Rise fall time: ≤ 30 ns							
Attenuation setting range	0 to 6 dB, 0.01 dB steps								
Connector*8	FC-type (standard model)						FC-PC type (standard model)		
Temperature range	-10° to +50°C (spec.meet), -40° to +70°C (storage)								
Dimensions and mass	31 (W) x 74 (H) x 178 (D) mm, ≤ 400 g				62 (W) x 74 (H) x 178 (D) mm, ≤ 500 g		62 (W) x 74 (H) x 178 (D) mm, ≤ 500 g(MG0927D/0928D) ≤ 600 g(MG0927J/0928J)		

*1: MG0927J and MG0928J are single units with two optical outputs

*2: 25°C, attenuator 0 dB

*3: CW, attenuator 0 dB

*4: CW, attenuator 0 dB, -10° to +50°C, 8 hours

*5: CW, 10° to 40°C, 8 hours

*6: CW, -10° to +50°C, 8 hours

*7: CW, $\pm 1^\circ\text{C}$ change at a temperature between -10° to +50°C, for one hour

*8: D4, DIN, DIAMOND and ST connectors are available as options.

For other connectors, please consult your nearest Anritsu representative.

Note: Above specifications are expressed for the case when 2 m of GI fiber (50/125 μm , NA 0.2) or SM fiber (10/125 μm , NA 0.1) is connected.

• Modulation Unit

Model	MG0902A
Modulation	Frequency: DC to 30 MHz Input: 0 to +0.8/+2 to +5 V, 75 Ω, BNC
Temperature range	-10° to +50°C (spec.meet), -40° to +70°C (storage)
Dimensions and mass	62 (W) x 74 (H) x 178 (D) mm, ≤400 g

Light source units selection guide

• LED Light Source Units

Fiber	Model	Wavelength	Output power	Number of channel	Features/Applications	
GI	MG0914E	0.85 μm	-13±1 dBm	1	GI fiber loss measurement	
GI/SM	MG0917A	1.3 μm	-20±1 dBm (GI) ≥-40 dBm (SM)	1	GI/SM fiber loss measurement	
	MG0918B	1.55 μm	≥-35 dBm (GI) ≥-50 dBm (SM)	1		
	MG0917B	1.31 μm	≥-35 dBm (GI) ≥-50 dBm (SM)	1	Narrow spectrum	GI/SM fiber high-precision loss measurement
	MG0917D	1.31 μm	≥-35 dBm (GI) ≥-50 dBm (SM)	2	Narrow spectrum	Low-loss measurement of optical fibers, optical devices, optical connectors, etc.
	MG0918D	1.55 μm	≥-35 dBm (GI) ≥-50 dBm (SM)	2	Excellent temperature stability	
SM	MG0927J	1.31 μm	≥-28 dBm	2	Two optical output in one unit	Edge-emitting LED use
	MG0928J	1.55 μm	≥-32 dBm	2	One optical output in one unit	SM fiber high-precision loss measurement
	MG0927D	1.31 μm	≥-28 dBm	2		High-loss measurement of optical fibers, optical devices
	MG0928D	1.55 μm	≥-32 dBm	2		

Ordering information

Please specify model/order number, name, and quantity when ordering.

Model/Order No.	Name
MG9001A	Main frame Stabilized Light Source
MG9002A	Stabilized Light Source
	Standard accessories (MG9001A)
	Power cord, 2.5 m: 1 pc
F0009	Fuse, 1.25 A (T1.25A250V): 2 pcs
F0039	Fuse, 0.2 A (MF51NN250V0.2ADC01): 1 pc
F0040	Fuse, 0.315 A (MF51NN250V0.315ADC01): 3 pcs
F0043	Fuse, 1 A (MF51NN250V1ADC01): 1 pc
F0044	Fuse, 1.6 A (MF51NN250V1.6ADC01): 2 pcs
E0007	Optical output control key: 2 pcs
W0487AE	MG9001A/MG9002A operation manual: 1 copy
	Standard accessories (MG9002A)
J0017	Power cord, 2.5 m: 1 pc
F0013	Fuse, 5 A (T5A250V): 2 pcs
F0040	Fuse, 0.315 A (MF51NN250V0.315ADC01): 2 pcs
F0043	Fuse, 1 A (MF51NN250V1ADC01): 2 pcs
F0045	Fuse, 2 A (MF51NN250V2ADC01): 1 pc
F0046	Fuse, 3.15 A (MF51NN250V3.15ADC01): 6 pcs
E0007	Optical output control key: 2 pcs
W0487AE	MG9001A/MG9002A operation manual: 1 copy
	Option
MG900[]A-02	Top cover for stacking

Model/Order No.	Name
	Plug-in units
MG0914E	LED Source (0.85 μm, GI)
MG0917A	LED Source (1.3 μm, GI)
MG0917B	LED Source (1.31 μm, GI/SM)
MG0917D	LED Source (1.31 μm, GI/SM)
MG0918B	LED Source (1.55 μm, GI/SM)
MG0918D	LED Source (1.55 μm, GI/SM)
MG0927D	Edge Emitting LED Source (1.3 μm, SM)
MG0927J	Edge Emitting LED Source (1.31 μm, SM)
MG0928D	Edge Emitting LED Source (1.55 μm, SM)
MG0928J	Edge Emitting LED Source (1.55 μm, SM)
MG0902A	Modulation Unit
	Application accessories
B0283	Blank panel
J0200B	FC-FC-2M-GI (FC optical fiber cord, 2 m, GI)
J0439B	FC · PC-FC · PC-2M-GI (FC · PC optical fiber cord, 2 m, GI)
J0056B	FC-FC-2M-SM (FC optical fiber cord, 2 m, SM)
J0635B	FC-PC-FC · PC-2M-SM (FC · PC optical fiber cord, 2 m, SM)
J0282	Optical fiber cord SGS driver
Z0173	MG9001A/MG9002A service kit
B0340	MG9001A hard carrying case (without casters)
B0341	MG9002A hard carrying case (with casters)

OPTICAL POWER METER
ML9001A

A Variety of Optical Sensors such as Si, Ge and InGas



The ML9001A is a single-channel digital-display optical power meter. It ensures accuracy and linearity over a wide wavelength range and greatly improves measurement reliability. It also has an improved basic performance. For example, measurements can be made over the wide level range from -100 to +20 dBm because internal reflection in the power sensors has been suppressed. The ML9001A also has many new functions that make it easier to use than other power meters. It can be used for all optical power measurements such as optical fiber loss measurement and optical device performance evaluation.

Features

• **Enables high-accuracy measurement**

The ML9001A accurately and automatically calibrates all the power sensors within the specified wavelength range and ensures a ±5% accuracy at -23 dBm. It also has a ±0.15 dB linearity (-23 dBm reference value). The ML9001A extends the guaranteed accuracy range of the measured values and enables high-accuracy measurement.

• **One power sensor for repeater maintenance and long-distance fiber loss measurement**

The MA9612A Optical Power Sensor has ultra-high sensitivity. Its measurement level range is -100 to ±3 dBm in the 1.3 μm band and it can sense either continuous light or modulated light. A single MA9612A can measure the near-end and far-end outputs of a repeater as well as measure long-distance fiber losses.

• **Multi-core fiber cable losses easily measured**

For modulated light measurement, the ML9001A has 12 modulation frequencies including 270 Hz. This meter can easily be used to measure multi-core fiber cable losses by using it with the MG9002A Stabilized Light Source (mounts up to 12 light source units).

• **Interchangeable optical connectors**

The optical connectors of all the power sensors accept adapters. This system allows the optical connectors to be interchanged so the ML9001A can be quickly used with various optical connectors. Since the internal coating of the optical power sensors suppresses reflected light, measurement errors are reduced in beam measurement (with or without an optical fiber).

• **Reduced measurement time**

The ML9001A has a much better response speed and stability than conventional optical power meters. With GPIB, it can measure at 30 ms/point so the measurement time can be reduced to less than 50% of conventional automatic measurement.

• **High-performance optical loss test set**

Stacking the ML9001A with the MG9001A Stabilized Light Source quickly configures a high-performance optical loss test set. Selecting various light source units and enables the ML9001A to measure all optical losses.

Specifications

• **ML9001A Optical Power Meter**

Indicator

Display	4 digit, W, W _(REL) , dBm, dB _(REL) selectable
Calibration coefficient	Adjustable
Recorder output	1 V/full-scale, linear output
Range select	Manual selection and automatic ranging
Measurement mode	Continuous and modulated light*1
Wavelength sensitivity correction	Automatic correction in 1 nm steps
Data memory	Max. 1000 data via GPIB
Dimensions and mass	213 (W) x 88 (H) x 250 (D) mm, ≤4 kg

Sensor

Model	MA9411A/A1	MA9412A	MA9611A
Wavelength range	0.38 to 1.15 μm		0.75 to 1.7 μm
Element	Si photodiode		InGaAs photodiode
Active area diameter	9.5 mm	–	–
Input type	Direct to photodiode	Connector*2	Connector*2
Dimensions and mass	40 (W) x 32 (H) x 62/73 (D) mm, ≤ 400 g	61 (W) x 42 (H) x 110 (D) mm, ≤ 800 g	40 (W) x 32 (H) x 65 (D) mm, ≤ 400 g

Model	MA9612A	MA9711A/A1	MA9712A	MA9714B
Wavelength range	0.75 to 1.7 μm	0.75 to 1.8 μm		
Element	InGaAs photodiode	Ge photodiode	Cooled-Ge photodiode	
Active area diameter	–	5 mm		–
Input type	Connector*2	Direct to photodiode		Connector*3
Dimensions and mass	61 (W) x 42 (H) x 110 (D) mm, ≤ 800 g	40 (W) x 32 (H) x 62/73 (D) mm, ≤ 400 g	42 (W) x 47 (H) x 110 (D) mm, ≤ 500 g	47 (W) x 61 (H) x 128 (D) mm, ≤ 800 g

Overall

Model	MA9411A/A1	MA9412A	MA9611A	
Optical power measurement range	Continuous light	-70 to $+10$ dBm*4 (0.1 nW to 10 mW)	-90 to 0 dBm*4 (1 pW to 1 mW)	-70 to $+3$ dBm*5 (0.1 nW to 2 mW)
	Modulated light	-70 to $+7$ dBm*6 (0.1 nW to 5 mW)	-90 to -3 dBm*6 (1 pW to 0.5 mW)	-80 to 0 dBm*7 (10 pW to 1 mW)
Measurement accuracy	Absolute accuracy (-23 dBm)	$\pm 5\%$ *8 (0.5 to 0.95 μm)		$\pm 5\%$ *9 (1.0 to 1.6 μm)
	Linearity continuous light: 23°C, -23 dBm as reference	± 0.15 dB*10 (± 0.45 dB for -70 to -60 dBm)	± 0.15 dB*10 (± 0.45 dB for -90 to -80 dBm)	± 0.15 dB*10 (± 0.45 dB for -70 to -60 dBm)
Resolution	W, W (REL) display: 0.1 to 1%, dBm display: 0.01 dB, dB (REL) display: 0.001 dB			
Power	100/115/120/200/220 Vac $\pm 10\%$, 240 Vac $\pm 4\%$, 50/60/400 Hz, ≤ 40 VA			
Operating temperature	0° to 50°C			
EMC*11	EN61326: 1997/A1: 1998 (Class A), EN61000-3-2: 1995/A2: 1998 (Class D), EN61326: 1997/A1: 1998 (Annex A)			
LVD	EN610101-1: 1993/A2, 1995 (Installation Category II, Pollution degree 2)			

Model	MA9612A	MA9711A/A1	MA9712A	MA9714B	
Optical power measurement range	Continuous light	-100 to $+3$ dBm*5 (0.1 pW to 2 mW)	-40 to $+10$ dBm*5 (0.1 μW to 10 mW)	-60 to $+10$ dBm*5 (1 nW to 10 mW)	-47 to $+23$ dBm*12 (20 nW to 200 mW)
	Modulated light	-90 to 0 dBm*7 (1 pW to 1 mW)	-60 to $+7$ dBm*7 (1 nW to 5 mW)	-70 to $+7$ dBm*7 (0.1 nW to 5 mW)	-57 to $+20$ dBm*13 (2 nW to 100 mW)
Measurement accuracy	Absolute accuracy (-23 dBm)	$\pm 5\%$ *9 (1.0 to 1.6 μm)	$\pm 5\%$ *9 (0.95 to 1.5 μm)	$\pm 4.5\%$ (1.3 μm) $\pm 5\%$ (0.95 to 1.6 μm)	$\pm 4.5\%$ (1.55 μm)*14 $\pm 5\%$ (0.95 to 1.6 μm)*15
	Linearity continuous light: 23°C, -23 dBm as reference	± 0.15 dB*10 (± 0.45 dB for -90 to -80 dBm)	± 0.15 dB*10 (± 0.45 dB for -40 to -30 dBm)	± 0.15 dB*10 (± 0.45 dB for -60 to -50 dBm)	± 0.15 dB*16 (-37 to $+20$ dBm, ± 0.45 dBm for -47 to -37 dBm)
Resolution	W, W (REL) display: 0.1 to 1%, dBm display: 0.01 dB, dB (REL) display: 0.001 dB				
Power	100/115/120/200/220 Vac $\pm 10\%$, 240 Vac $\pm 4\%$, 50/60/400 Hz, ≤ 40 VA				
Operating temperature	0° to 50°C				
EMC*11	EN61326: 1997/A1: 1998 (Class A), EN61000-3-2: 1995/A2: 1998 (Class D), EN61326: 1997/A1: 1998 (Annex A)				
LVD	EN610101-1: 1993/A2, 1995 (Installation Category II, Pollution degree 2)				

- *1: Twelve modulation frequencies including 270 Hz and 1 kHz
- *2: FC-type connector standard
- *3: Only for PC type SM fiber (10/125 μm , NA 0.1)
- *4: At 0.85 μm
- *5: At 1.3 μm
- *6: At 0.85 μm , 270 Hz
- *7: At 1.3 μm , 270 Hz
- *8: For wavelengths other than 0.85 μm , specified at 23° $\pm 5^\circ\text{C}$

- *9: For wavelengths other than 1.3 μm , specified at 23° $\pm 5^\circ\text{C}$
- *10: At 23° $\pm 5^\circ\text{C}$
- *11: Electromagnetic compatibility
- *12: At 1.55 μm
- *13: At 1.55 μm , 270 Hz
- *14: At 1.55 μm , 0 dBm
- *15: At 0 dBm
- *16: Reference = 0 dBm

Note: When an optical fiber is used, performance is guaranteed for a fiber core diameter of up to 62.5 μm and an NA of up to 0.29. When any other fiber is used, a measurement error may occur.

• **Optical connector options**

Option No.	Optical connector
21	D4
22	RUNGE
23*1	Amphenol 906 type
34	DIAMOND (ø 3.5)
35*1	HP-SMA, Amphenol 905 type
36	Amphenol 905 type
38	ST
39	DIN
40	SC
41*2	TOCP172
43	HMS-10/A
45	FC

*1: If adapter mounted on MA9412A/9612A, repeatability may be reduced.

*2: For MA9411A

Ordering information

Please specify model/order number, name, and quantity when ordering.

Model/order No.	Name
ML9001A	Main frame Optical Power Meter
J0313	Standard accessories (for ML9001A) Sensor connecting cord A, 2 m (for MA9412A/9612A/9712A/9714B): 1 pc
J0314	Sensor connecting cord B, 2 m (for MA9411A/A1, MA9611A and MA9711A/A1): 1 pc
F0004	Power cord, 2.5 m: 1 pc
F0007	Fuse, 0.4 A (T400MA250V): 2 pcs
W0420AE	Fuse, 0.8 A (T800MA250V): 2 pcs
W0420BE	ML9001A operation manual: 1 copy ML9001A service manual: 1 copy
MA9411A/A1*1	Optical power sensors Optical Power Sensor
MA9412A	Optical Power Sensor (with J0480A connector adapter)
MA9611A	Optical Power Sensor (with MA9005A connector adapter)
MA9612A	Optical Power Sensor (with J0480A connector adapter)
MA9711A/A1*1	Optical Power Sensor
MA9712A	Optical Power Sensor
MA9714B*2	Optical Power Sensor
MA9001B*3	Optional accessories Connector Adapter (FC type, for MA9411A/MA9711A)
J0480A*3	Connector adapter (FC type, for MA9412A)
J0480B*3	Connector adapter (FC type, for MA9612A)
MA9005A*3	Connector Adapter (FC type, for MA9611A)
MP92B*3	Connector Adapter (FC type, for MA9712A)
MA9013A*3	Fiber Adapter (with FC type plug, for fibers with 125 µm clad dia., 0.25 to 1.0 mm jacket dia.)
MP916A	Fiber Adapter (for MA9002A and MP94A, for plastic fiber with 1 mm dia.)
MP93A	Fiber Adapter (≤150 µm clad dia., 0.8 to 1.0 mm jacket dia.)
MP94A	Adapter (for MA9712A, used with MP93A)
MA9002A	Adapter (for MA9411A/MA9711A, used with MP93A)
MA9805A	Optical Attenuator (for MA9411A, 10 dB)
MA9306A	Optical Attenuator (for MA9711A, 10 dB)
MZ8010A	Optical Sensor Holder (securely mounts MA9411A/A1 or MA9711A/A1 for measuring light traveling through free space)
J0007	GPIB cable, 1 m
J0008	GPIB cable, 2 m
B0186	Front cover
J0617B*4	Replaceable optical connector (FC)
J0618D*4	Replaceable optical connector (ST)
J0618E*4	Replaceable optical connector (DIN)
J0618F*4	Replaceable optical connector (HMS-10/A)
J0619B*4	Replaceable optical connector (SC)

*1: MA9411A1 and MA9711A1 are lateral input sensors.

*2: Specify one of FC, ST, DIN, SC or DIAMOND (HMS-10A).

When the connector type is not specified, FC is supplied.

*3: The optical connector of the standard product is FC. Please specify the option numbers along with model names shown in the tables, if you need a different optical connector.

*4: For MA9714B

ML9001A with sensor

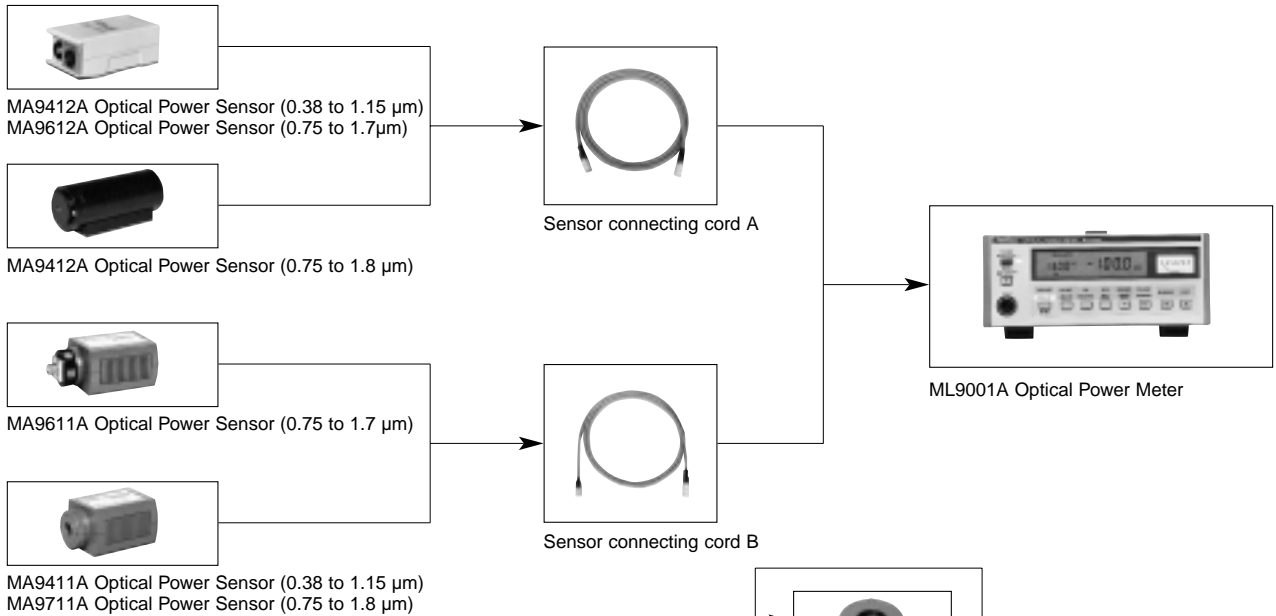

Adapters (option)

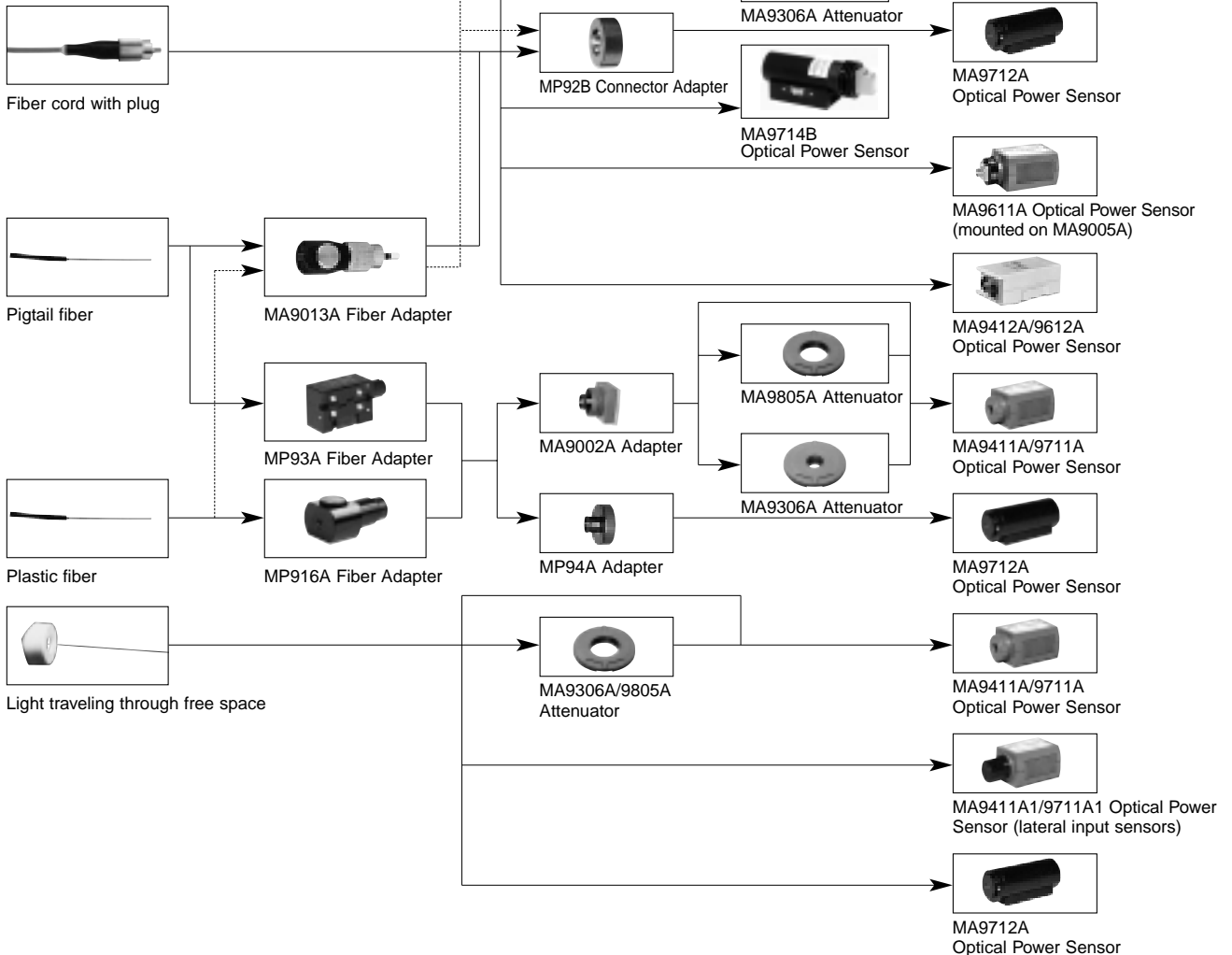

OPTICAL HANDY POWER METER
ML9002A

For Easy Optical Power Measurement



The ML9002A is a compact handy power meter with a measurement level as wide as other more expensive instruments. Seven optical sensors are available for different wavelengths, measurement levels, and optical input types. Each can be calibrated for three common wavelengths so absolute optical power can be read directly. Each optical sensor can either be incorporated directly in the main frame or connected using a connecting cord. The ML9002A can be used to check optical disks, optical printers and optical communications systems and can back-up on-side operations as a powerful multifunctional measuring instrument for maintenance.

Features

• **Accurate optical power measurement**

The power of a narrow beam can be accurately measured even when an adapter is changed because anti-reflection optical sensor is used.

• **Long-distance measurement with wide measurement level range**

An unprecedented wide measurement level has been achieved in this handy optical power meter. Optical power of -70 to +3 dBm (MA9621A Optical Power Sensor) in the 1.3 μm band and -70 to +10 dBm (MA9423A Optical Power Sensor) in the 0.85 μm band can be measured.

• **Direct absolute power readings for three wavelengths**

Each optical sensor is calibrated at three wavelengths (0.633/0.78/0.85 μm or 0.66/0.78/0.85 μm for short wavelengths, and 0.85/1.3/1.55 μm for long wavelengths). The absolute power is indicated automatically just by switching to the measured wavelength.

• **Flexible measurements**

Two types of connections, a plug-in system (sensor incorporated into main frame) or a cord system (sensor connected using connecting cord), are possible so that measurement capabilities are flexible.

• **Monitoring without cutting optical fiber**

The optical power in an optical fiber cable (ø0.25 mm, UV-coated fiber) can be measured by using the MA9722A Optical Power Sensor.

• **Compatible with various connectors**

The ML9002A can be quickly connected to FC, D4, RUNGE, ST, DIN, DIAMOND, and SC connectors just by replacing the connector adapter.

Optical Sensors
MA9421A, MA9423A, MA9621A, MA9721A, MA9723A

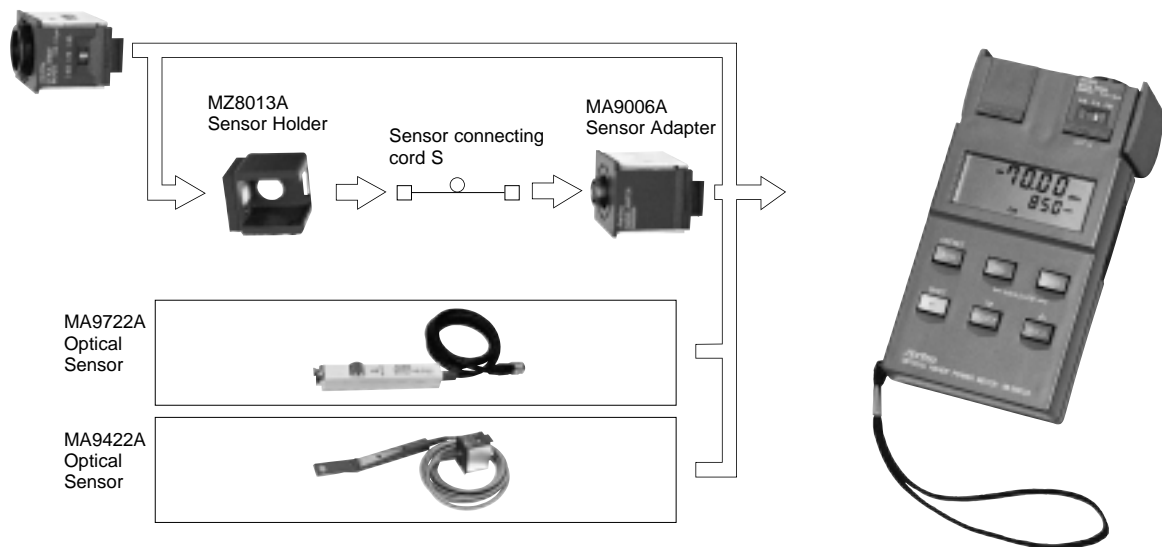

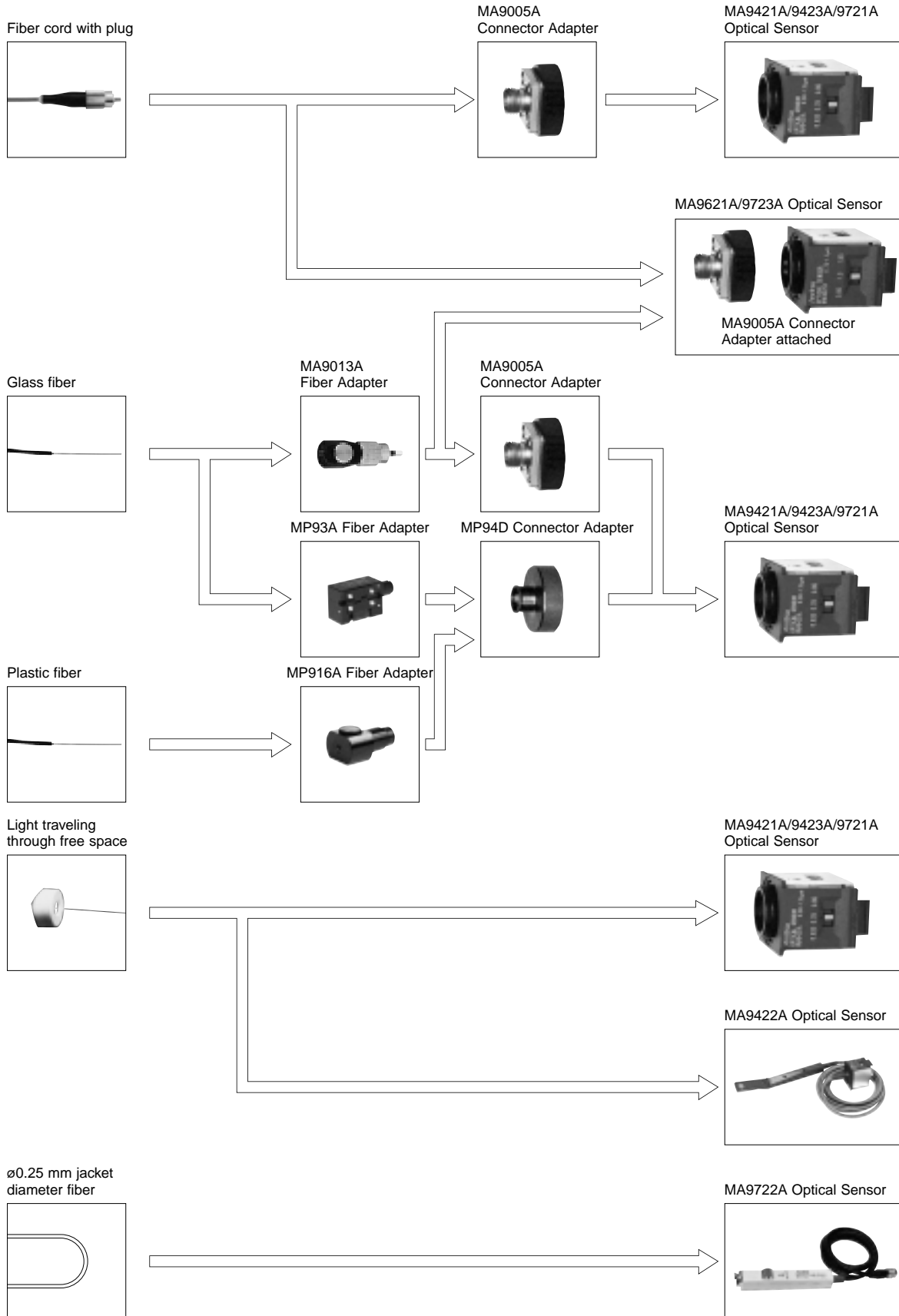

Specifications

Main frame	Unit display	W, W(REL), dBm, and dB(REL), selectable, 4 digits						
	Recorder output	1 V/full-scale, 0.316 V/-5 dB						
	Averaging	ON/OFF settings						
	Range hold	Range settings						
	Buzzer	1 dB sound threshold level setting						
	Auto power off	After 5 minutes non-use (with internal Ni-Cd battery)						
	Dimensions and mass	90 (W) x 196 (H) x 38 (D) mm, ≤700 g						
Sensors	Model	MA9421A	MA9422A	MA9423A	MA9621A	MA9721A	MA9723A	MA9722A
	Wavelength (μm)	0.38 to 1.15			0.75 to 1.7		0.75 to 1.8	
	Element	Si photodiode			InGaAs photodiode	Ge photodiode		
	Active area diameter	9.5 mm	9 mm	9.5 mm	1 mm	5 mm	1 mm	3 mm
	Input	Direct			FC connector adapter*1	Direct	FC connector adapter*1	Direct*2
	Measurement range (dBm)	-60 to +20 (at 0.85 μm)	-50 to +20 (at 0.85 μm)	-70 to +10 (at 0.85 μm)	-70 to +3 (at 1.3 μm)	-40 to +10 (at 1.3 μm)	-60 to +3(at 1.3 μm, 0° to 40°C)	-50 to 0 (at 1.3 μm, 0° to 40°C)
	Dimensions and mass	30 (W) x 30 (H) x 37 (D) mm, ≤100 g	15 (W) x 16 (H) x 140 (D) mm, ≤200 g	30 (W) x 30 (H) x 37 (D) mm, ≤100 g				20 (W) x 20 (H) x 128 (D) mm, ≤300 g
Overall	Measurement accuracy	±5% (-10 dBm, CW mode)				±5% (-10 dBm, CW mode)*3		Not specified
	Calibration wavelength	0.633/0.78/0.85 μm		0.66/0.78/0.85 μm	0.85/1.3/1.55 μm		Not specified	
	Measurement resolution	W/W(REL): 0.1 to 1%, dBm/dB(REL): 0.01 dB						
	Operating hours	20 hr or more, floating operation possible (on internal Ni-Cd battery)						
	Temperature range	Operating: 0° to 50°C, Storage: -30° to 50°C, Recharging: 10° to 45°C						
	EMC	EN61326: 1997/A1, 1998 (Class A) EN61000-3-2: 1995/A2, 1998 (Class D) EN61326: 1997/A1, 1998 (Annex A)						
	LVD	EN610101-1: 1993/A2, 1995 (Installation Category II, Pollution degree 2)						

*1: Used for NA ≤0.29 core diameter fiber ≤62.5 μm

*2: Used for 0.25 μm jacket diameter fiber

*3: For 1.55 μm wavelength, it is specified at 23° ±5°C

Ordering information

Please specify model/order number, name, and quantity when ordering.

Model/Order No.	Name
ML9002A	Main frame Optical Handy Power Meter
MA9421A	Optical sensors Optical Sensor
MA9422A	Optical Sensor (Thin sensor)
MA9423A	Optical Sensor
MA9621A	Optical Sensor (MA9005A Connector Adapter attached)
MA9721A	Optical Sensor
MA9722A	Optical Sensor (fiber identification sensor)
MA9723A	Optical Sensor (MA9005A Connector Adapter attached)
Z0178	Standard accessories AC adapter: 1 pc Power cord, 2.5 m: 1 pc
B0232	Blank panel: 1 pc
W0400CE	ML9002A instruction manual: 1 copy
J0477	Auto-power-off override plug: 1 pc
MA9005A*	Optional accessories Connector Adapter (for optical sensor)
MA9006A	Sensor Adapter (for sensor connecting cord S/T)
MP93A	Fiber Adapter (≤150 μm clad dia., 0.8 to 1.0 mm jacket dia.)
MP94D	Connector Adapter (for MP93A and MP916A)
MA9013A	Fiber Adapter
MZ8013A	Sensor Holder
J0056B	FC-FC-2M-SM (FC optical fiber cord, 2 m, SM)
J0200B	FC-FC-2M-GI (FC optical fiber cord, 2 m, GI)
J0436	Sensor connecting cord S (for ML9002A sensors)
J0438	Recorder output cord
Z0179	Carrying case (with shoulder strap)
Z0182	Soft case
B0234	Battery box

*: Choose from the options listed in the following table when ordering non-FC optical connector.

Optical connector options table

Option No.	Optical connector
21	D4
22	RUNGE
23	Amphenol Type 906
24	OF-2
34	DIAMOND*1
35	HP-SMA, Amphenol Type 905
38	ST
39	DIN
40	SC
41	TOCP172*2

*1: 3.5 mm diameter ferrule, M9 screw

*2: For MA9421A, MA9423A only

OPTICAL TEST SET
MT9810A

Basic Measuring Instrument for Optical Systems

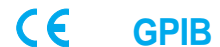

The MT9810A offers superior accuracy and reliability for evaluating a wide range of optical devices and systems. It has a full range of plug-in type, high-output DFB-LDs complying with the ITU-T recommended wavelength grid, as well as high-accuracy optical sensors. It ensures effective support for future needs as a basic measuring instrument.

Superior operability is achieved through use of an easy-to-read 7 mm high, seven-segment and full dot matrix display. And a complete range of replaceable optical connectors eliminate all connection problems while making cleaning easy. GPIB and RS-232C interfaces are standard and configuration of a remote control system is simplified using the bundled LabVIEW® software drivers.

*: LabVIEW® is a registered trademark of National Instruments Corp.

Feature

- Flexibility for every application
- For WDM systems
- Measurement EDFAs and Raman amplifiers

Performance

• Wide dynamic range

Optical loss of up to 120 dB can be measured using the high-output (+10 dBm) light sources and the high-sensitivity (-110 dBm min.) sensors.

• High-output, high-stability DFB-LD light sources

The DFB-LD light sources have a high output of +10 dBm while achieving a stability of better than $\leq \pm 0.005$ dB and a center optical frequency stability of better than $\leq \pm 2$ GHz, facilitating high-stability and high reliability measurement.

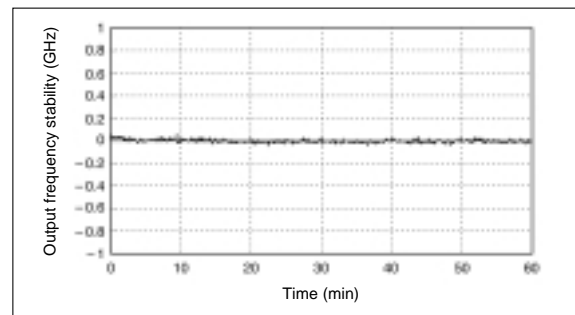
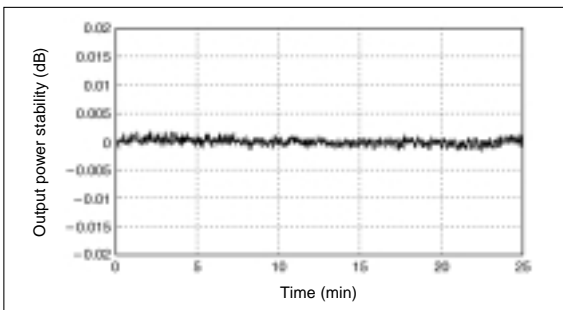

• Conforms to ITU-T wavelength grid

A complete line up of DFB-LD light sources for optical frequencies meeting the ITU-T recommendations for Dense-WDM (DWDM) networks (191.7 to 195.9 THz at 100 GHz interval) is available.

• High-accuracy optical power measurement

Under reference conditions, the optical power measurement uncertainty is $\leq \pm 2\%$, and under actual operating conditions it is $\leq \pm 3.5\%$ with a linearity of better than $\leq \pm 0.01$ dB. These excellent specifications permit measurement of optical power with high accuracy and repeatability.

• Sensors with high return loss and low polarization dependency

Even without a reflection-suppression adapter, the sensor return loss and polarization dependency are 40 dB min. and 0.02 dB max. respectively, making them ideal for evaluating devices and systems that use optical amplifiers.

• High-speed analog output

The optical sensors have a maximum bandwidth of 100 kHz (approx. 3 dB), permitting measurement of optical power variations with a response speed of approx. 10 μ s.

• High-resolution optical power measurement

The MT9810A has a display resolution of 0.001 dB and optical power can be measured at a high resolution of 0.0001 dB via the GPIB and RS-232C interfaces.

Functions and applications

• Variable optical frequency

The center optical frequency of the DFB-LDs can be varied in a range of ≤ 60 GHz (approx. ≤ 0.5 nm). Moreover, it can be displayed in frequency and wavelength units [λ (nm) = c (m/s)/ f (Hz)], where c is the velocity of light in a vacuum (2.99792×10^8 m/s)].

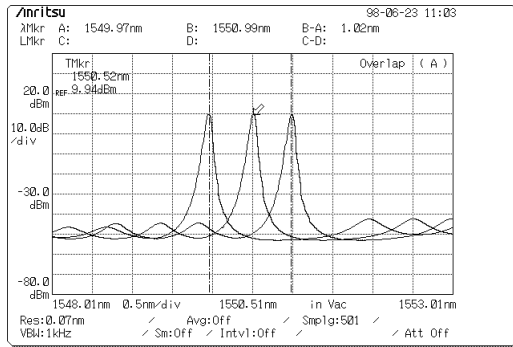

• Variable optical power measurement interval and bandwidth

The best optical power measurement interval can be set according to the application; for example, a long interval for long-term measurement and a short interval for high-speed measurement. Additionally, the average power of a pulsed optical signal can be measured by narrowing the band, and the variations in optical power at optical switching can be measured by widening the band.

• Measurement of max. and min. optical power and variation

There is no need to save the measured optical power in memory because the maximum and minimum optical powers and variation are always displayed, permitting real-time evaluation of optical stability and polarization dependent loss (PDL).

• Measurement conditions saved and copied

Up to 10 sets of measurement conditions can be saved for each channel (one of the 10 sets can be set as the default). Moreover, when channel 1 and channel 2 use the same type of unit, the measurement conditions for one side can be copied to the other side.

• Saved measured optical power

A maximum of 1000 power measurements per channel can be saved, and the saved measurements can be read by remote control, permitting various analyses and processing.

• Evaluation of WDM device wavelength characteristics

By combining the MG9637A/9638A Tunable Laser Source with the MT9810A, wavelength-loss characteristic measurements of WDM device (filter etc.) are possible.

• Insertion loss and optical attenuation measurement of optical couplers/splitters

Combining a light source and optical sensor permits measurement of the insertion loss and isolation of optical couplers and Arrayed Waveguide Grating (AWG), etc. with a wide dynamic range of 120 dB max. Moreover, the high linearity of ± 0.01 dB facilitates attenuation evaluation of optical attenuators.



Optical insertion loss measurement using relative value (MT9810A display)

• Optical switching characteristics

Optical switching times up to about 10 μ s can be evaluated by inputting the analog output to an oscilloscope, etc.

• Optical fiber loss

When an optical sensor and light source are combined, optical fiber loss can be measured. Near-end and far-end measurements are possible using various reference values.

Parameter (PRMTR) setting



Reference data input (MT9810A display)

Ref function



Measurement relative to reference data (MT9810A display)

• Polarization dependent loss (PDL) of optical devices

The PDL of the device under test can be read directly from the variation width using the Max. and Min. functions by inputting an optical signal scrambled by a polarization controller to the DUT and measuring the output with an optical sensor.

• Optical pulse average power measurement

Average power is used to evaluate the power of an optical pulse with a long repetition cycle. At this time, the optical sensor bandwidth is switched to narrow band to measure the optical pulse average power. If the pulse duty is known, the peak power can be back-calculated. (However, there is some error due to the extinction ratio of the intensity modulation and the waveform distortion.)

$$P_{\text{peak}} (W) = \frac{P_{\text{average}} (W)}{\text{Duty} (\%)/100}$$

Specifications

• MT9810A Optical Test Set (main frame)

Display resolution	dBm: 0.001, 0.01, 0.1 dB: 0.001, 0.01, 0.1 W: 5 digits
Display range	-199.999 to +199.999 dBm, ± 0.0001 pW to ± 10000 W
Display	Fluorescent character display tube, 7 segments (5-1/2 digits), 2 screens, dot matrix (138 x 20 dots), dedicated segments (AUTO, AVG, MOD, CAL, SYS, PRMTR, APPL, REMOTE)
System settings	Remote (GPIB, RS-232C) GPIB: Address RS-232C Data length: 7/8 bits, Stop bit: 1/2 bits Parity bit: None, odd, even Speed: 1200, 2400, 4800, 9600, 14400, 19200 bps Buzzer volume: 4 levels, Contrast: 9 levels Time setting: Year, month, day, hour, minute, second (24 hour display)
Functions	General Settings save: 10 max. (each channel) Settings copy: Between channels (only for same type of unit) Selectable controlled channel Using optical sensor Bar graph display: 60 dots Record measurement: 1000 max. data (each channel) Calculations: Channel subtraction, max./min./(max. - min.) displays, relative value display (measured value reference, numeric value input), calibration value correction
Remote control	GPIB, RS-232C
Laser safety mechanism	Remote inter-lock, optical output control (key control)
Environmental conditions	Operating temperature/humidity: 0° to 50°C/≤90% (no condensation); storage temperature: -25° to 71°C
Plug-in units	2 max.
LabVIEW® driver	Bundled as standard
Dimensions and mass	213 (W) x 88 (H) x 351 (D) mm, ≤3.5 kg
Power supply	100 to 120/200 to 240 Vac (+10%/−15%), ≤70 VA, 47.5 to 63 Hz
EMC	EN61326: 1997/A1, 1998 (Class A) EN61000-3-2: 1995/A2, 1998 (Class A) EN61326: 1997/A1, 1998 (Annex A)
LVD	EN610101-1: 1993/A2, 1995 (Installation Category II, Pollution degree 2)

• DFB-LD light sources

Model	MU952501A/952502A/952503A/952504A/952505A	MU952601A/952602A/952603A/952604A/952605A/952606A
Optical element	DFB-LD	
Applicable optical fiber	SM (ITU-T G.652)	
Specified wavelength range (fp) ^{*1}	191.7 to 195.9 THz (1563.86 to 1530.33 nm)	186.3 to 191.6 THz (1609.19 to 1564.68 nm)
Center optical frequency ^{*2}	fp ± 0.01 THz (approx. ± 0.08 nm)	
Spectrum half width ^{*2}	≤30 MHz	
Optical output power ^{*2}	+10 ± 1 dBm	+7 ± 1 dBm
Optical power stability	Time stability (short term) ^{*2, *3, *4} : $\leq \pm 0.005$ dB Time stability (long term) ^{*2, *3, *5} : $\leq \pm 0.02$ dB Temperature stability ^{*2, *3, *6} : $\leq \pm 0.25$ dB	Time stability (short term) ^{*2, *3, *4} : $\leq \pm 0.01$ dB Time stability (long term) ^{*2, *3, *5} : $\leq \pm 0.02$ dB Temperature stability ^{*2, *3, *6} : $\leq \pm 0.25$ dB
Center frequency stability	Time stability (short term) ^{*2, *4} : $\leq \pm 2$ GHz (approx. ± 0.02 nm) Time stability (long term) ^{*2, *5} : $\leq \pm 4$ GHz (approx. ± 0.04 nm)	
Optical frequency tuning	Tuning range: fp ± 60 GHz (approx. ± 0.48 nm), Step: 1 GHz (approx. 0.01 nm) Accuracy ^{*2} : $\leq \pm 10$ GHz (setting to fp + 60 GHz or fp - 60 GHz, 25°C)	
Internal modulation	Frequency ^{*2} : 270 Hz, 1 kHz, 2 kHz $\pm 0.1\%$ Duty: 50% $\pm 5\%$, Extinction ratio: ≥ 13 dB	
Optical output attenuation	0.00 to 6.00 dB (0.01 dB steps), Accuracy: $\leq \pm 0.5$ dB (at 25°C when set to 6.00 dB)	
Laser safety mechanism	IEC60825-1: Class 3A, 21CFR1040.10: Class IIIb	
Optical connector	FC-PC, ST, DIN, HMS-10/A, SC ^{*7}	
Warm-up time	1 h (after optical output on)	
Environmental conditions	Operating temperature/humidity: +15° to +35°C/≤90% (no condensation); Storage temperature: -25° to +71°C	
Dimensions and mass	41 (W) x 78 (H) x 335 (D) mm, ≤700 g	

Note: Wavelengths in vacuum

*1: Specify an optical frequency (wavelength) and model name from the ordering information.

*2: At CW, optical attenuation setting (0.00 dB), center optical frequency (fp) using SM fiber (ITU-T G.652) and FC-PC connector

*3: When return loss seen from light source side is 40 dB min.

*4: 5 min at constant temperature (at one point from 20 to 30°C)

*5: 1 h at constant temperature

*6: 8 h at 15° to 35°C

*7: Specified connector for optical connector option supplied as standard accessory.
If connector not specified, FC-PC (Option 37) supplied as standard.

• FP-LD light sources

Model	MU951301A	MU951501A	MU951001A*1
Optical element	FP-LD		
Fiber	SM fiber (ITU-T G.652)		
Wavelength*2	1310 ±20 nm	1550 ±20 nm	1310/1550 ±20 nm
Spectral half-width*2	≤5 nm	≤10 nm	≤5 nm (1310 nm), ≤10 nm (1550 nm)
Optical output power*2	+7 ±1 dBm		
Optical output power stability	Time stability (short term)*2, *3, *4: ≤±0.002 dB Time stability (long term)*2, *3, *5: ≤±0.02 dB Temperature stability*2, *3, *6: ≤±0.1 dB		Time stability (short term)*2, *3, *4: ≤±0.005 dB Time stability (long term)*2, *3, *5: ≤±0.05 dB Temperature stability*2, *3, *6: ≤±0.15 dB
Internal modulation	Frequency: 270 Hz, 1 kHz, 2 kHz ±0.1%, Duty: 50% ±5%, Extinction ratio: ≥13 dB		
Optical output attenuation	0.00 to 6.00 dB (0.01 dB steps), Accuracy: ≤±0.5 dB (at 25°C when set to 6.00 dB)		
Laser safety mechanism	IEC60825-1: Class 3A, 21CFR1040.10: Class IIIb		
Optical connector	FC-PC, ST, DIN, HMS-10/A, SC*7		
Warm-up time	1 h (after optical output on)		
Environmental conditions	Operating temperature/humidity: 0° to +50°C/≤90% (no condensation); Storage Temperature: -25° to +71°C		
Dimensions and mass	41 (W) x 78 (H) x 335 (D) mm, ≤700 g		

Note: Wavelengths in vacuum

- *1: Only one MU951001A can be installed into MT9812B.
- *2: At CW, optical attenuation setting (0.00 dB), using SM fiber (ITU-T G.652) and FC-PC connector
- *3: When return loss seen from light source side is 40 dB min.
- *4: 15 min at constant temperature (at one point from 20 to 30°C)
- *5: 6 h at constant temperature
- *6: 8 h at 0° to 50°C
- *7: Specified connector for optical connector option supplied as standard accessory. If connector not specified, FC-PC (Option 37) supplied as standard.

Laser product safety protection

MU952501A/952502A/952503A/952504A/952505A, MU952601A/952602A/952603A/952604A/952605A/952606A and MU951301A/951501A/951001A are laser products and safety protection conforming to optical safety standards IEC 60825-1 and 21CFR1040.10 (USA) is incorporated; the following warning label is affixed to the product.

• **21CFR1040.10 warning label (example)**

MU952501A/952502A/952503A/952504A/952505A



• **IEC 60825-1 warning label (example)**

MU952501A/952502A/952503A/952504A/952505A

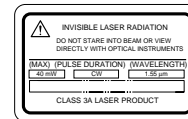

• **Optical sensors**

Model	MU931311A	MU931421A	MU931422A
Element	InGaAs-PD		
Input type	Fiber		
Applicable optical fiber	SM (ITU-T G.652)		9/125 to 62.5/125 μm (NA: ≤0.29)
Wavelength range	800 to 1600 nm	750 to 1700 nm	
Optical power measurement range*1	CW: +10 to -110 dBm MOD: +7 to -90 dBm	CW: +10 to -80 dBm MOD: +7 to -90 dBm	
Noise level*2	≤-93 dBm	≤-73 dBm	
Polarization dependency*3	≤0.02 dB		≤0.05 dB
Return loss*3	≥40 dB		-
Optical power measurement uncertainty	Reference conditions*4: ±2%, Operating conditions*5: ±3.5%		
Linearity*6	±0.05 dB (+10 to 0 dBm), ±0.01 dB ±0.3 pW (-90 to 0 dBm)	±0.05 dB (+10 to 0 dBm), ±0.01 dB ±30 pW (-70 to 0 dBm)	
Calibration factor input	-99.999 to +99.999 dB		
Wavelength sensitivity correction	Measurement wavelength input in 0.01 nm units		
Zero set operation	Automatic zero calibration		
Range select	Auto, manual		
Modulated light reception	CW/MOD selectable, MOD: 270 Hz, 1 kHz, 2 kHz		
Measurement interval*7	1, 10, 20, 50, 100, 200, 500 ms, 1 s to 99 h 59 min 59 s		
Average setting	Off, 2, 5, 10, 20, 50, 100, 200, 500, 1000 times		
Analog output*8	Approx. +2 V		
Bandwidth select*9	Auto, manual Manual setting: 0.1, 1, 10, 100 Hz, 1, 10, 100 kHz (CW mode only)	Auto, manual Manual setting: 0.1, 1, 10, 100 Hz, 1, 10 kHz (CW mode only)	

Continued on next page

Model	MU931311A	MU931421A	MU931422A
Optical connector*10	FC-PC, ST, DIN, HMS-10/A, SC		
Environmental conditions	Operating temperature/humidity: 0° to +50°C/≤90% (no condensation); storage: -40° to +71°C		
Dimensions and mass	41 (W) x 78 (H) x 335 (D) mm, ≤700 g	41 (W) x 78 (H) x 335 (D) mm, ≤550 g	

*1 Wavelength: 1300 nm

*2 Measurement interval: 100 ms, average: 10 times, peak to peak noise, wavelength: 1300 nm

*3 SM fiber (ITU-T G.652), return loss: ≥45 dB, wavelength: 1550 nm

*4 Reference conditions

SM fiber (ITU-T G.652), master FC connector

Power level: 100 μW (-10 dBm), CW light, wavelength: 1300 nm, ambient temperature: 23° ±2°C

At day of calibration, warm-up: 1 h (MU931311A) and 30 min (MU931421A/931422A)

*5 Operating conditions

SM Fiber (ITU-T G.652), master FC connector, CW light, any wavelength in 1000 to 1600 nm (MU931311A) and 1000 to 1650 nm (MU931421A/931422A), ambient temperature: 23° ±5°C, within 1 year after calibration, warm-up: 1 h (MU931311A) and 30 min (MU931421A/931422A), Uncertainty increase by 1% if either a fiber other than a SM fiber (ITU-T G.652) or an APC connector is used with the MU931422A.

*6 Measurement conditions: Constant temperature within 23° ±5°C, bandwidth: auto/0.1/1/10 Hz, any wavelength in 1000 to 1600 nm (MU931311A) and 1000 to 1650 nm (MU931421A/931422A), CW light, power level: 100 μW (-10 dBm) reference, warm-up: 1 h (MU931311A) and 30 min (MU931421A/931422A)

*7 Only record measurements for measurement interval of ≤100 ms

*8 Full-scale value for each measurement range

*9 Approx. 3 dB bandwidth. Response time at bandwidth setting of 100 kHz varies according to analog output amplitude

*10 Specify connector for optical connector option supplied as standard accessory. If connector not specified, FC-PC (Option 37) supplied as standard.

• MA9331A (with MU931001A Optical Sensor Adapter)

Sensor element	InGaAs-PD
Input type	Fiber
Supported fiber	9/125 to 62.5/125 μm (NA: ≤0.29)
Wavelength range	940 to 1640 nm
Optical power measurement range*1	+35 to -50 dBm
Noise level	≤-43 dBm
Polarization dependent loss*2	≤0.01 dB (PC connector), ≤0.05 dB (APC connector)
Optical power measurement accuracy	±3% (at +30 dBm)*3, ±4% (at +30 dBm)*4
Linearity*5	±0.05 dB ±30 nW (-40 to +35 dBm)
Environmental conditions	Operating temperature/humidity: 0° to +40°C/≤90% (no condensation) Storage temperature/humidity: -40° to +71°C/≤90% (no condensation)
Dimensions and mass	60 (W) x 78 (H) x 90 (D) mm, ≤750 g

*1 1550 nm

*2 SM fiber (ITU-T G.652), 1550 nm

*3 Reference conditions: SM fiber (ITU-T G.652), 1550 nm, APC connector, +30 dBm, CW light, 23° ±2°C (RH: 60% ±10%)

*4 Operating conditions: SM fiber (ITU-T G.652), 980 nm ±1 nm, 1240 to 1340 nm, 1440 to 1640 nm, APC connector, +30 dBm, CW light, 23° ±5°C (2% increase when using wavelength outside above range), RH: 60% ±10%

*5 Constant temperature within 23° ±5°C range

Ordering information

Please specify the model/order number, name and quantity when ordering.

Model/Order No.	Name	Model/Order No.	Name
MT9810A	Main frame Optical Test Set	MU952504A	Light Source
J0895	Standard accessories RCA short pin (for remote inter-lock): 1 pc RCA plug (for remote inter-lock): 1 pc Key (for laser output control): 2 pcs Fuse, 2 A (for 100/200 Vac): 2 pcs Blank panel: 1 pc Power cord, 2.6 m: 1 pc LabVIEW® driver (3.5 inch FD): 1 pc MT9810A operation manual: 1 copy MT9810A remote control operation manual: 1 copy	MU952505A	Light Source
J0896		MU952601A	Light Source
Z0391		MU952602A	Light Source
F0011		MU952603A	Light Source
B0425		MU952604A	Light Source
MX981001A		MU952605A	Light Source
W1428AE		MU952606A	Light Source
W1483AE		MU951301A	Light Source
		MU951501A	Light Source
		MU951001A	Light Source
MT9810A-01	Option High power sensor option (for MA9331A)		Standard accessory Optical connector adapter*
B0438B	Application parts Rack mount kit (for one MT9810A) Rack mount kit (for two MT9810A) 8P modular cable, 1 m 8P modular cable, 2 m 8P modular cable, 5 m 8P modular cable, 10 m Protective cover		Options
B0438		MU952501A-01	Light source (fp: 193.10 THz, 1552.52 nm)
J0897B		MU952501A-02	Light source (fp: 193.20 THz, 1551.72 nm)
J0897C		MU952501A-03	Light source (fp: 193.30 THz, 1550.92 nm)
J0897D		MU952501A-04	Light source (fp: 193.40 THz, 1550.12 nm)
J0897E		MU952501A-05	Light source (fp: 193.50 THz, 1549.32 nm)
B0427		MU952501A-06	Light source (fp: 193.60 THz, 1548.51 nm)
		MU952501A-07	Light source (fp: 193.70 THz, 1547.72 nm)
	MU952501A-08	Light source (fp: 193.80 THz, 1546.92 nm)	
	MU952501A-09	Light source (fp: 193.90 THz, 1546.12 nm)	
	MU952501A-10	Light source (fp: 194.00 THz, 1545.32 nm)	
MU952501A		MU952502A-01	Light source (fp: 192.10 THz, 1560.61 nm)
MU952502A		MU952502A-02	Light source (fp: 192.20 THz, 1559.79 nm)
MU952503A		MU952502A-03	Light source (fp: 192.30 THz, 1558.98 nm)

Continued on next page

Model/Order No.	Name
MU952502A-04	Light source (fp: 192.40 THz, 1558.17 nm)
MU952502A-05	Light source (fp: 192.50 THz, 1557.36 nm)
MU952502A-06	Light source (fp: 192.60 THz, 1556.55 nm)
MU952502A-07	Light source (fp: 192.70 THz, 1555.75 nm)
MU952502A-08	Light source (fp: 192.80 THz, 1554.94 nm)
MU952502A-09	Light source (fp: 192.90 THz, 1554.13 nm)
MU952502A-10	Light source (fp: 193.00 THz, 1553.33 nm)
MU952503A-07	Light source (fp: 191.70 THz, 1563.86 nm)
MU952503A-08	Light source (fp: 191.80 THz, 1563.05 nm)
MU952503A-09	Light source (fp: 191.90 THz, 1562.23 nm)
MU952503A-10	Light source (fp: 192.00 THz, 1561.42 nm)
MU952504A-01	Light source (fp: 194.10 THz, 1544.53 nm)
MU952504A-02	Light source (fp: 194.20 THz, 1543.73 nm)
MU952504A-03	Light source (fp: 194.30 THz, 1542.94 nm)
MU952504A-04	Light source (fp: 194.40 THz, 1542.14 nm)
MU952504A-05	Light source (fp: 194.50 THz, 1541.35 nm)
MU952504A-06	Light source (fp: 194.60 THz, 1540.56 nm)
MU952504A-07	Light source (fp: 194.70 THz, 1539.77 nm)
MU952504A-08	Light source (fp: 194.80 THz, 1538.98 nm)
MU952504A-09	Light source (fp: 194.90 THz, 1538.19 nm)
MU952504A-10	Light source (fp: 195.00 THz, 1537.40 nm)
MU952505A-01	Light source (fp: 195.10 THz, 1536.61 nm)
MU952505A-02	Light source (fp: 195.20 THz, 1535.82 nm)
MU952505A-03	Light source (fp: 195.30 THz, 1535.04 nm)
MU952505A-04	Light source (fp: 195.40 THz, 1534.25 nm)
MU952505A-05	Light source (fp: 195.50 THz, 1533.47 nm)
MU952505A-06	Light source (fp: 195.60 THz, 1532.68 nm)
MU952505A-07	Light source (fp: 195.70 THz, 1531.90 nm)
MU952505A-08	Light source (fp: 195.80 THz, 1531.12 nm)
MU952505A-09	Light source (fp: 195.90 THz, 1530.33 nm)
MU952601A-01	Light source (fp: 191.10 THz, 1568.77 nm)
MU952601A-02	Light source (fp: 191.20 THz, 1567.95 nm)
MU952601A-03	Light source (fp: 191.30 THz, 1567.13 nm)
MU952601A-04	Light source (fp: 191.40 THz, 1566.31 nm)
MU952601A-05	Light source (fp: 191.50 THz, 1565.50 nm)
MU952601A-06	Light source (fp: 191.60 THz, 1564.68 nm)
MU952602A-01	Light source (fp: 190.10 THz, 1577.03 nm)
MU952602A-02	Light source (fp: 190.20 THz, 1576.20 nm)
MU952602A-03	Light source (fp: 190.30 THz, 1575.37 nm)
MU952602A-04	Light source (fp: 190.40 THz, 1574.54 nm)
MU952602A-05	Light source (fp: 190.50 THz, 1573.71 nm)
MU952602A-06	Light source (fp: 190.60 THz, 1572.89 nm)
MU952602A-07	Light source (fp: 190.70 THz, 1572.06 nm)
MU952602A-08	Light source (fp: 190.80 THz, 1571.24 nm)
MU952602A-09	Light source (fp: 190.90 THz, 1570.42 nm)
MU952602A-10	Light source (fp: 191.00 THz, 1569.59 nm)
MU952603A-01	Light source (fp: 189.10 THz, 1585.36 nm)
MU952603A-02	Light source (fp: 189.20 THz, 1584.53 nm)
MU952603A-03	Light source (fp: 189.30 THz, 1583.69 nm)
MU952603A-04	Light source (fp: 189.40 THz, 1582.85 nm)
MU952603A-05	Light source (fp: 189.50 THz, 1582.02 nm)
MU952603A-06	Light source (fp: 189.60 THz, 1581.18 nm)
MU952603A-07	Light source (fp: 189.70 THz, 1580.35 nm)
MU952603A-08	Light source (fp: 189.80 THz, 1579.52 nm)
MU952603A-09	Light source (fp: 189.90 THz, 1578.69 nm)
MU952603A-10	Light source (fp: 190.00 THz, 1577.86 nm)
MU952604A-01	Light source (fp: 188.10 THz, 1593.79 nm)
MU952604A-02	Light source (fp: 188.20 THz, 1592.95 nm)
MU952604A-03	Light source (fp: 188.30 THz, 1592.10 nm)
MU952604A-04	Light source (fp: 188.40 THz, 1591.26 nm)
MU952604A-05	Light source (fp: 188.50 THz, 1590.41 nm)
MU952604A-06	Light source (fp: 188.60 THz, 1589.57 nm)
MU952604A-07	Light source (fp: 188.70 THz, 1588.73 nm)
MU952604A-08	Light source (fp: 188.80 THz, 1587.88 nm)
MU952604A-09	Light source (fp: 188.90 THz, 1587.04 nm)
MU952604A-10	Light source (fp: 189.00 THz, 1586.20 nm)
MU952605A-01	Light source (fp: 187.10 THz, 1602.31 nm)
MU952605A-02	Light source (fp: 187.20 THz, 1601.46 nm)
MU952605A-03	Light source (fp: 187.30 THz, 1600.60 nm)
MU952605A-04	Light source (fp: 187.40 THz, 1599.75 nm)
MU952605A-05	Light source (fp: 187.50 THz, 1598.89 nm)
MU952605A-06	Light source (fp: 187.60 THz, 1598.04 nm)

Model/Order No.	Name
MU952605A-07	Light source (fp: 187.70 THz, 1597.19 nm)
MU952605A-08	Light source (fp: 187.80 THz, 1596.34 nm)
MU952605A-09	Light source (fp: 187.90 THz, 1595.49 nm)
MU952605A-10	Light source (fp: 188.00 THz, 1594.64 nm)
MU952606A-03	Light source (fp: 186.30 THz, 1609.19 nm)
MU952606A-04	Light source (fp: 186.40 THz, 1608.33 nm)
MU952606A-05	Light source (fp: 186.50 THz, 1607.47 nm)
MU952606A-06	Light source (fp: 186.60 THz, 1606.60 nm)
MU952606A-07	Light source (fp: 186.70 THz, 1605.74 nm)
MU952606A-08	Light source (fp: 186.80 THz, 1604.88 nm)
MU952606A-09	Light source (fp: 186.90 THz, 1604.03 nm)
MU952606A-10	Light source (fp: 187.00 THz, 1603.17 nm)
Applications parts	
J0617B	Replaceable optical connector (FC, user replaceable)
J0618D	Replaceable optical connector (ST, user replaceable)
J0618E	Replaceable optical connector (DIN, user replaceable)
J0618F	Replaceable optical connector (HMS-10/A, user replaceable)
J0619B	Replaceable optical connector (SC, user replaceable)
J0952A	Conversion cord (FC · PC-FC · APC), 1 m
J0954A	Conversion cord (SC · PC-SC · APC), 1 m
Z0282	Ferrule cleaner
Z0283	Ferrule cleaning tape (6 pcs/set)
Z0284	Adapter cleaner (stick type, 200 pcs/set)
Optical sensor	
MU931311A	Optical sensor
MU931421A	Optical sensor
MU931422A	Optical sensor (MA9005A Connector Adapter attached)
MA9331A	Optical Sensor (with MA9008A, requires MU931001A: sold separately)
Standard accessories	
W1624AE	Optical connector adapter (for MU931311A/931421A)* MU931422A operation manual (for MU931422A): 1 pc
Applications parts	
MA9008A	Connector Adapter*
MU931001A	Sensor Adapter
J0617B	Replaceable optical connector (FC, user replaceable)
J0618D	Replaceable optical connector (ST, user replaceable)
J0618E	Replaceable optical connector (DIN, user replaceable)
J0618F	Replaceable optical connector (HMS-10/A, user replaceable)
J0619B	Replaceable optical connector (SC, user replaceable)
MA9005A-37	Connector adapter (FC, for MU931422A)
MA9005A-38	Connector adapter (ST, for MU931422A)
MA9005A-39	Connector adapter (DIN, for MU931422A)
MA9005A-40	Connector adapter (SC, for MU931422A)
MA9005A-43	Connector adapter (HMS-10/A, for MU931422A)
MA9008A-37	FC-PC connector
MA9008A-38	ST connector
MA9008A-39	DIN connector
MA9008A-40	SC connector
MA9008A-43	HMS-10/A connector
MA9008A-32	MU connector
Z0282	Ferrule cleaner
Z0283	Ferrule cleaning tape (6 pcs/set)
Z0284	Adapter cleaner (stick type, 200 pcs/set)
J0635B	Optical fiber cord (FC-PC · FC-PC · 2M-SM), 2 m
J0127A	Coaxial cord (BNC-P · RG-58A/U · BNC-P), 1 m
J0003A	Coaxial cord (SMA-P · 3D-2W · SMA-P), 1 m
J0901A	Coaxial adapter (SMA-P · BNC-J)
J0902A	Coaxial adapter (SMA-J · BNC-P)
MA9013A	Fiber Adapter (for bare fiber)
Optical connector options (for light sources and optical sensors)	
[Model]-37	FC-PC connector (user replaceable)
[Model]-38	ST connector (user replaceable)
[Model]-39	DIN connector (user replaceable)
[Model]-40	SC connector (user replaceable)
[Model]-43	HMS-10/A connector (user replaceable)
[Model]-32	MU connector (user replaceable)

* Specify one of the optical connector options as a standard accessory at ordering. Specify by appending the option number to the model. If nothing is specified, the FC-PC connector (Option 37) will be supplied as the standard connector.

MULTI CHANNEL BOX
MT9812B

For Adding Light Sources and Optical Sensors for Maximum of 9 Channels



The MT9812B is a nine-channel mainframe providing high accuracy and reliable applications for the evaluation of various optical devices and systems including WDM. It can incorporate up to nine units of DFB-LD light sources and high-accuracy optical sensors which support optical frequencies conformable to ITU-T recommendations. Moreover, by adopting the format of a plug-in unit, it can meet a wide range of requirements. Setting of each unit and checking of the setting conditions can be carried out on the front panel. In addition, GPIB and RS-232C are provided as standards, making it easy to configure the measuring system based on the remote control.

Specifications

• MT9812B Multi Channel Box

Plug-in units*1	9 max.
Display	7 segments LED, 7 digits (sign: 1 digit, numerical value: 6 digits)
Remote control	GPIB, RS-232C
Laser safety mechanism	Remote inter-lock, optical output control (key control)
Environmental conditions	Operating temperature/humidity*2: 0° to 40°C/≤90% (no condensation) Storage temperature: -30° to +71°C
Power	AC 85 to 132/170 to 250 V, 47.5 to 63 Hz, ≤250 VA
Dimensions and mass	426 (W) x 133 (H) x 451 (D) mm, ≤9 kg (without units)
EMC	EN61326: 1997/A1, 1998 (Class A) EN61000-3-2: 1995/A2, 1998 (Class A) EN61326: 1997/A1, 1998 (Annex A)
LVD	EN610101-1: 1993/A2, 1995 (Installation Category II, Pollution degree 2)

*1: Only one MU951001A can be installed into MT9812B

*2: Narrowest temperature range of the plug-in units or MT9812B

• DFB-LD light sources

Same as MT9810A (see page 66)

• FP-LD light sources

Same as MT9810A (see page 67)

• Optical sensors

Same as MT9810A (see page 67)

Ordering information

Please specify the model/order number, name and quantity when ordering.

Model/Order No.	Name
MT9812B	Main frame Multi Channel Box
	Standard accessories
J0895	RCA short pin (for remote inter-rock): 1 pc
J0896	RCA plug (for remote inter-rock): 1 pc
Z0391	Key (for laser output control): 2 pcs
F0013	Fuse, 5 A (for 100/200 Vac): 2 pcs
	Power cord, 2.6 m: 1 pc
B0425	Blank panel: 8 pcs
W1555AE	MT9812B operation manual: 1 copy
	Option
MT9812B-01	High power sensor option (for MA9331A)
	Application parts
J0006	GPIB cable, 0.5 m
J0007	GPIB cable, 1 m
J0008	GPIB cable, 2 m
J0009	GPIB cable, 4 m
J0655A	RS-232C cable (9P-25P, cross)
J0654A	RS-232C cable (9P-9P, cross)
	Light source units
MU952501A	Light Source
MU952502A	Light Source
MU952503A	Light Source
MU952504A	Light Source
MU952505A	Light Source
MU952601A	Light Source
MU952602A	Light Source
MU952603A	Light Source
MU952604A	Light Source
MU952605A	Light Source
MU952606A	Light Source
MU951301A	Light Source
MU951501A	Light Source
MU951001A	Light Source
	Standard accessory
	Optical connector adapter*
	Options
MU952501A-01	Light source (fp: 193.10 THz, 1552.52 nm)
MU952501A-02	Light source (fp: 193.20 THz, 1551.72 nm)
MU952501A-03	Light source (fp: 193.30 THz, 1550.92 nm)
MU952501A-04	Light source (fp: 193.40 THz, 1550.12 nm)
MU952501A-05	Light source (fp: 193.50 THz, 1549.32 nm)
MU952501A-06	Light source (fp: 193.60 THz, 1548.51 nm)
MU952501A-07	Light source (fp: 193.70 THz, 1547.72 nm)
MU952501A-08	Light source (fp: 193.80 THz, 1546.92 nm)
MU952501A-09	Light source (fp: 193.90 THz, 1546.12 nm)
MU952501A-10	Light source (fp: 194.00 THz, 1545.32 nm)
MU952502A-01	Light source (fp: 192.10 THz, 1560.61 nm)
MU952502A-02	Light source (fp: 192.20 THz, 1559.79 nm)
MU952502A-03	Light source (fp: 192.30 THz, 1558.98 nm)
MU952502A-04	Light source (fp: 192.40 THz, 1558.17 nm)
MU952502A-05	Light source (fp: 192.50 THz, 1557.36 nm)
MU952502A-06	Light source (fp: 192.60 THz, 1556.55 nm)
MU952502A-07	Light source (fp: 192.70 THz, 1555.75 nm)
MU952502A-08	Light source (fp: 192.80 THz, 1554.94 nm)
MU952502A-09	Light source (fp: 192.90 THz, 1554.13 nm)
MU952502A-10	Light source (fp: 193.00 THz, 1553.33 nm)
MU952503A-07	Light source (fp: 191.70 THz, 1563.86 nm)
MU952503A-08	Light source (fp: 191.80 THz, 1563.05 nm)
MU952503A-09	Light source (fp: 191.90 THz, 1562.23 nm)
MU952503A-10	Light source (fp: 192.00 THz, 1561.42 nm)
MU952504A-01	Light source (fp: 194.10 THz, 1544.53 nm)
MU952504A-02	Light source (fp: 194.20 THz, 1543.73 nm)
MU952504A-03	Light source (fp: 194.30 THz, 1542.94 nm)
MU952504A-04	Light source (fp: 194.40 THz, 1542.14 nm)
MU952504A-05	Light source (fp: 194.50 THz, 1541.35 nm)
MU952504A-06	Light source (fp: 194.60 THz, 1540.56 nm)
MU952504A-07	Light source (fp: 194.70 THz, 1539.77 nm)
MU952504A-08	Light source (fp: 194.80 THz, 1538.98 nm)
MU952504A-09	Light source (fp: 194.90 THz, 1538.19 nm)
MU952504A-10	Light source (fp: 195.00 THz, 1537.40 nm)
MU952505A-01	Light source (fp: 195.10 THz, 1536.61 nm)
MU952505A-02	Light source (fp: 195.20 THz, 1535.82 nm)
MU952505A-03	Light source (fp: 195.30 THz, 1535.04 nm)

Model/Order No.	Name
MU952505A-04	Light source (fp: 195.40 THz, 1534.25 nm)
MU952505A-05	Light source (fp: 195.50 THz, 1533.47 nm)
MU952505A-06	Light source (fp: 195.60 THz, 1532.68 nm)
MU952505A-07	Light source (fp: 195.70 THz, 1531.90 nm)
MU952505A-08	Light source (fp: 195.80 THz, 1531.12 nm)
MU952505A-09	Light source (fp: 195.90 THz, 1530.33 nm)
MU952601A-01	Light source (fp: 191.10 THz, 1568.77 nm)
MU952601A-02	Light source (fp: 191.20 THz, 1567.95 nm)
MU952601A-03	Light source (fp: 191.30 THz, 1567.13 nm)
MU952601A-04	Light source (fp: 191.40 THz, 1566.31 nm)
MU952601A-05	Light source (fp: 191.50 THz, 1565.50 nm)
MU952601A-06	Light source (fp: 191.60 THz, 1564.68 nm)
MU952602A-01	Light source (fp: 190.10 THz, 1577.03 nm)
MU952602A-02	Light source (fp: 190.20 THz, 1576.20 nm)
MU952602A-03	Light source (fp: 190.30 THz, 1575.37 nm)
MU952602A-04	Light source (fp: 190.40 THz, 1574.54 nm)
MU952602A-05	Light source (fp: 190.50 THz, 1573.71 nm)
MU952602A-06	Light source (fp: 190.60 THz, 1572.89 nm)
MU952602A-07	Light source (fp: 190.70 THz, 1572.06 nm)
MU952602A-08	Light source (fp: 190.80 THz, 1571.24 nm)
MU952602A-09	Light source (fp: 190.90 THz, 1570.42 nm)
MU952602A-10	Light source (fp: 191.00 THz, 1569.59 nm)
MU952603A-01	Light source (fp: 189.10 THz, 1585.36 nm)
MU952603A-02	Light source (fp: 189.20 THz, 1584.53 nm)
MU952603A-03	Light source (fp: 189.30 THz, 1583.69 nm)
MU952603A-04	Light source (fp: 189.40 THz, 1582.85 nm)
MU952603A-05	Light source (fp: 189.50 THz, 1582.02 nm)
MU952603A-06	Light source (fp: 189.60 THz, 1581.18 nm)
MU952603A-07	Light source (fp: 189.70 THz, 1580.35 nm)
MU952603A-08	Light source (fp: 189.80 THz, 1579.52 nm)
MU952603A-09	Light source (fp: 189.90 THz, 1578.69 nm)
MU952603A-10	Light source (fp: 190.00 THz, 1577.86 nm)
MU952604A-01	Light source (fp: 188.10 THz, 1593.79 nm)
MU952604A-02	Light source (fp: 188.20 THz, 1592.95 nm)
MU952604A-03	Light source (fp: 188.30 THz, 1592.10 nm)
MU952604A-04	Light source (fp: 188.40 THz, 1591.26 nm)
MU952604A-05	Light source (fp: 188.50 THz, 1590.41 nm)
MU952604A-06	Light source (fp: 188.60 THz, 1589.57 nm)
MU952604A-07	Light source (fp: 188.70 THz, 1588.73 nm)
MU952604A-08	Light source (fp: 188.80 THz, 1587.88 nm)
MU952604A-09	Light source (fp: 188.90 THz, 1587.04 nm)
MU952604A-10	Light source (fp: 189.00 THz, 1586.20 nm)
MU952605A-01	Light source (fp: 187.10 THz, 1602.31 nm)
MU952605A-02	Light source (fp: 187.20 THz, 1601.46 nm)
MU952605A-03	Light source (fp: 187.30 THz, 1600.60 nm)
MU952605A-04	Light source (fp: 187.40 THz, 1599.75 nm)
MU952605A-05	Light source (fp: 187.50 THz, 1598.89 nm)
MU952605A-06	Light source (fp: 187.60 THz, 1598.04 nm)
MU952605A-07	Light source (fp: 187.70 THz, 1597.19 nm)
MU952605A-08	Light source (fp: 187.80 THz, 1596.34 nm)
MU952605A-09	Light source (fp: 187.90 THz, 1595.49 nm)
MU952605A-10	Light source (fp: 188.00 THz, 1594.64 nm)
MU952606A-03	Light source (fp: 186.30 THz, 1609.19 nm)
MU952606A-04	Light source (fp: 186.40 THz, 1608.33 nm)
MU952606A-05	Light source (fp: 186.50 THz, 1607.47 nm)
MU952606A-06	Light source (fp: 186.60 THz, 1606.60 nm)
MU952606A-07	Light source (fp: 186.70 THz, 1605.74 nm)
MU952606A-08	Light source (fp: 186.80 THz, 1604.88 nm)
MU952606A-09	Light source (fp: 186.90 THz, 1604.03 nm)
MU952606A-10	Light source (fp: 187.00 THz, 1603.17 nm)
	Applications parts
J0617B	Replaceable optical connector (FC, user replaceable)
J0618D	Replaceable optical connector (ST, user replaceable)
J0618E	Replaceable optical connector (DIN, user replaceable)
J0618F	Replaceable optical connector (HMS-10/A, user replaceable)
J0619B	Replaceable optical connector (SC, user replaceable)
J0952A	Conversion cord (FC · PC-FC · APC), 1 m
J0954A	Conversion cord (SC · PC-SC · APC), 1 m
Z0282	Ferrule cleaner
Z0283	Ferrule cleaning tape (6 pcs/set)
Z0284	Adapter cleaner (stick type, 200 pcs/set)
	Optical sensor
MU931311A	Optical Sensor
MU931421A	Optical Sensor
MU931422A	Optical Sensor (MA9005A Connector Adapter attached)
MA9331A	Optical Sensor (with MA9008A, requires MU931001A: sold separately)

Continued on next page

Model/Order No.	Name
	Standard accessories
W1624AE	Optical connector adapter (for MU931311A/931421A)* MU931422A operation manual (for MU931422A): 1 pc
	Applications parts
MA9008A	Connector Adapter*
MU931001A	Sensor Adapter
J0617B	Replaceable optical connector (FC, user replaceable)
J0618D	Replaceable optical connector (ST, user replaceable)
J0618E	Replaceable optical connector (DIN, user replaceable)
J0618F	Replaceable optical connector (HMS-10/A, user replaceable)
J0619B	Replaceable optical connector (SC, user replaceable)
MA9005A-37	Connector adapter (FC, for MU931422A)
MA9005A-38	Connector adapter (ST, for MU931422A)
MA9005A-39	Connector adapter (DIN, for MU931422A)
MA9005A-40	Connector adapter (SC, for MU931422A)
MA9005A-43	Connector adapter (HMS-10/A, for MU931422A)
MA9008A-37	FC-PC connector
MA9008A-38	ST connector
MA9008A-39	DIN connector
MA9008A-40	SC connector
MA9008A-43	HMS-10/A connector
MA9008A-32	MU connector
Z0282	Ferrule cleaner
Z0283	Ferrule cleaning tape (6 pcs/set)
Z0284	Adapter cleaner (stick type, 200 pcs/set)
J0635B	Optical fiber cord (FC-PC · FC-PC · 2M-SM), 2 m
J0127A	Coaxial cord (BNC-P · RG-58A/U · BNC-P), 1 m
J0003A	Coaxial cord (SMA-P · 3D-2W · SMA-P), 1 m
J0901A	Coaxial adapter (SMA-P · BNC-J)
J0902A	Coaxial adapter (SMA-J · BNC-P)
MA9013A	Fiber Adapter (for bare fiber)
	Optical connector options (for light sources and optical sensors)
[Model]-37	FC-PC connector (user replaceable)
[Model]-38	ST connector (user replaceable)
[Model]-39	DIN connector (user replaceable)
[Model]-40	SC connector (user replaceable)
[Model]-43	HMS-10/A connector (user replaceable)
[Model]-32	MU connector (user replaceable)

*: Specify one of the optical connector options as a standard accessory at ordering. Specify by appending the option number to the model. If nothing is specified, the FC-PC connector (Option 37) will be supplied as the standard connector.

OPTICAL LOSS TEST SET
MS9020D

For Measuring Optical Loss and Checking Optical Parts



The MS9020D is a handy optical measuring instrument that incorporates an LD or an LED light source and an optical power meter. It can also be used for return loss measurement. Every unit of the LD light source (4 types), LED source (7 types), the sensors (8 types) and the return loss measurement unit (1 type) is a plug-in type, for easy exchange and highest suitability for field use.

The MS9020D covers 0.66 μm , 0.85 μm , 1.3 μm , and 1.55 μm bands for optical loss measurement. In addition to the CW mode, it provides a modulated light mode with 270 Hz, 1 kHz, and 2 kHz modulation signals. Therefore, it is possible to measure optical loss over a wide dynamic range without stray light effect. This is the most suitable for single mode fiber measurement. For return loss, 1.3 μm band single mode fibers can be measured in the 0 to 40 dB range. As a power meter, every sensor has a wavelength calibration function of 5 nm steps at 3 wavelengths, so absolute values can be read directly.

Features

- Measures optical loss up to 67 dB
- Measures CW and modulated light
- Provides calibration function of 5 nm steps at 3 wavelengths
- Also measures optical return loss (0 to 40 dB)
- Operates in 3 modes; AC, rechargeable battery, and dry cells
- Various connectors

Specifications

• MS9020D (mainframe)

Unit display	W, W (REL), dBm, dB (REL) selectable, 4 digits
Measurement resolution	W/W (REL) display: 0.1 to 1%, dBm/dB (REL) display: 0.01/0.1 dB, Blanking is possible.
Auto power off	Power turns off automatically after 5 minutes of no adjustment
Recorder output	1 V (on full-scale display), 0.316 V (on -5 dB from full-scale)
Battery alarm	Down-side part flickers when battery voltage goes down.
Auto offset	Sensor zero point is adjusted automatically.
Back light	Display section back light can be set on and off.
Averaging	On and off selectable
Range hold	Range can be specified and set to be on and off.
Reference value input	Used to input the loss point reference value
Buzzer	Sound when input level is higher than set reference level in 1 dB steps
Wavelength sensitivity characteristics compensation	Deviation of optical power sensor is compensated automatically in 5 nm steps.

Applications

• Optical fiber loss measurement

When measuring optical fibers, it is convenient to provide one MS9020D each at both the near and far ends. By using switchable light source units (MS0904A/B, MS0909A), one-touch measurement of 0.85/1.3 μm and 1.3/1.55 μm can be done.

More accurate loss measurement is possible by using the modulated light function. When an LD light source is used, it is possible to measure optical loss up to 67 dB.

• Optical parts performance check

A light source and optical power meter are provided, and an optical parts performance check is possible at low cost.

• Optical return loss measurement

Return loss of connectors or optical devices can be measured easily using return loss measuring units.

Continued on next page

Resume function	At power on, the state when the power is just turned off is restored.
Backup	Setting condition is backed up for 30 minutes, when the line voltage is zero at exchanging batteries for example.
Modulation	CW, 270 Hz, 1 kHz, 2 kHz (2 kHz is for MA9621A only)
Power	Operation is possible using AC adapter, Ni-Cd battery [Operation hour: 4-hour for outputting light, No operation hour: 9-hour for light is turned off (when fully charged after new battery fully discharged), Charge time: 6-hour], UM-3 Alkali/Manganese battery*1 (Require 4 pcs. Operation hour is equivalent with Ni-Cd battery at 25°C.)
Temperature range	0° to 50°C (use), 10° to 45°C (at charging), -30° to +50°C (storage)
Dimensions and mass	90 (W) x 190 (H) x 38 (D) mm, ≤700 g
EMC	EN61326: 1997/A1: 1998 (Class A), EN61000-3-2: 1995/A2: 1998 (Class D), EN61326: 1997/A1: 1998 (Annex A)
LVD	EN610101-1: 1993/A2, 1995 (Installation Category II, Pollution degree 2)

*1: Optional accessories

• Light sources

Model	MS0901A*1	MS0902A*1	MS0903A*1	MS0904A*1	MS0904B*1	MS0905A*1
Applicable fiber	GI	SM, GI			SM	Plastics
Element	LED				EE-LED	LED
Wavelength (μm)	0.85 ±0.03	1.3 ±0.03	1.55 ±0.035	1.3 ±0.03 1.55 ±0.035	1.31 ±0.02 1.55 ±0.035	0.66 ±0.03
Spectral half-width (nm)	≤60	≤140	≤210	≤140 (1.3 μm) ≤210 (1.55 μm)	≤25	≤50
Optical output level: CW mode (dBm)*2	≥-20*3	≥-20*3 ≥-40*4	≥-25*3 ≥-45*4	≥-22 (1.3 μm)*3 ≥-27 (1.55 μm)*3 ≥-42 (1.3 μm)*4 ≥-47 (1.55 μm)*4	≥-36 (1.3 μm)*4 ≥-42 (1.55 μm)*4	≥-10*5
Stability*2,*6	≤0.3 dB				≤2 dB	≤0.4 dB
Short-term stability*2,*7	≤0.04 dB				≤0.05 dB	
Internal modulation	Frequency: 270 Hz/1 kHz/2 kHz±1.5%, Square wave (duty factor: 45 to 55%)					
Optical connector*8	FC, ST, DIN, HMS-10/A, SC type connector adapter				FC, ST, DIN, HMS-10/A, SC type integrated with connector	Amphenol 905, FC type connector adapter
Temperature range	0° to 50°C (use), -40° to +70°C (storage)					
Dimensions and mass	30 (W) x 30 (H) x 37 (D) mm, ≤200 g					

Model	MS0906A*9	MS0902D*10,*11	MS0903D*10,*11	MS0908A*12,*13	MS0909A*10,*12	
Applicable fiber	GI, SM	SM			SM (ITU-T G.652)	
Element	LED	LD			FP-LD	
Wavelength (μm)	0.85 ±0.03 1.30 ±0.03	1.31 ±0.025*14	1.55 ±0.025*14	0.635 ±0.010*14	1.31 ±0.02*14 1.55 ±0.02*14	
Spectral half-width (nm)	≤60 (0.85 μm) ≤140 (1.30 μm)	≤5*14	≤10*14	≤5*14	≤5 (1.31 μm)*14 ≤10 (1.55 μm)*14	
Optical output level: CW mode (dBm)*2	≥22 (0.85/1.3 μm)*3 ≥-42 (1.3 μm)*4	-3±1*4,*14			-3±1*14,*15	≥-3*14,*15
Stability*2,*6	≤0.3 dB	±0.5 dB*4			±2 dB*2,*15,*16	±0.5 dB*2,*6,*15
Short-term stability*2,*7	≤0.04 dB	±0.05 dB*4			-	±0.05 dB*2,*7,*15
Internal modulation	Frequency: 270 Hz/1 kHz/2 kHz±1.5%, Square wave (duty factor: 45 to 55%)			Flickering light function (3 steps)	Frequency: 270 Hz/1 kHz/2 kHz ±1.5% Duty: 45 to 55%	
Optical connector*8	FC, ST, DIN, HMS-10/A, SC type connector adapter	FC or SC type integrated with connector*17			Replaceable connector, PC polish (FC, ST, DIN, HMS-10A, SC)	
Temperature range	0° to 50°C (use), -40° to +70°C (storage)			0° to 40°C (use), -40° to +70°C (storage)	0° to 50°C (use), -40° to +70°C (storage)	
Dimensions and mass	30 (W) x 30 (H) x 37 (D) mm, ≤200 g			90 (W) x 133 (H) x 38 (D) mm, ≤300 g	90 (W) x 133 (H) x 38 (D) mm, ≤500 g	

*1: Installed in MS9020A/B/C/D

*2: Used with FC-type connectors

*3: When connected with Anritsu GI fiber (50/125 μm, NA 0.2, 2 m)

*4: When connected with Anritsu SM fiber (10/125 μm, NA 0.1, 2 m)

*5: When connected with Anritsu plastic fiber (1 mmφ, NA 0.5, 2 m)

*6: CW, 0° to 50°C (5 hour)

*7: CW, at ±1°C (1 minute) within 0° to 50°C

*8: Specify one connector among those shown in the specification table.

When no connector and manufacturer's name are specified, FC-type (Amphenol 905 type for MS0905A) will be mounted and supplied. Other than the connectors indicated in the table are dealt in special connectors of custom-made. The ordering method of optical connectors are indicated in the table on page 39.

*9: Installed in MS9020B/C/D

*10: Laser Product Safety Standards: Class-1 (IEC Pub. 825, FDA 21CFR)

*11: Installed in MS9020C/D

*12: Installed in MS9020D

*13: Laser Product Safety Standards: Class-2 (IEC Pub. 825, FDA 21CFR)

*14: CW, 25°C

*15: Connected with SM fiber (ITU-T G.652), 2 m

*16: CW, at 0° to 40°C ambient temperature, 5 hour

*17: Use the conversion cord (see ordering information) for other optical connectors

• Optical sensors

Model	MA9421A*1	MA9422A*1	MA9423A*1	MA9621A*1
Wavelength range	0.38 to 1.15 μm			0.75 to 1.7 μm
Element	Si diode			InGaAs diode
Active area diameter	ø9.5 mm	ø9 mm	ø9.5 mm	ø1 mm
Input	Direct			FC, ST, DIN, HMS-10/A, SC type connector adapter*2
Measurement range	CW (dBm)	-60 to +20 (0.85 μm)	-50 to +20 (0.85 μm)	-70 to +10 (0.85 μm)
	MOD (dBm)	-65 to +17 (0.85 μm)	-50 to +17 (0.85 μm)	-75 to +7 (0.85 μm)
Measurement accuracy*3	±5%*4			±5%*5
Temperature range	0° to 50°C (use), -40° to +70°C (storage)			
Dimensions and mass	30 (W) x 30 (H) x 37 (D) mm, ≤100 g	15 (W) x 16 (H) x 140 (D) mm, ≤200 g	30 (W) x 30 (H) x 37 (D) mm, ≤100 g	

Model	MA9622A*7,*8	MA9721A*1	MA9722A*1	MA9723A*1
Wavelength range	1.2 to 1.7 μm	0.75 to 1.8 μm		
Element	InGaAs diode	Ge diode		
Active area diameter	-	ø5 mm	ø3 mm	ø1 mm
Input	FC, SC, ST, DIN, HMS-10/A, replaceable connector, PC polishing	Direct	Direct*9	FC, ST, DIN, HMS-10/A, SC type connector adapter*2
Measurement range	CW (dBm)	-50 to +23 (1.3/1.55 μm)	-40 to +10 (1.3 μm)	-60 to 0*10 (1.3 μm)
	MOD (dBm)	-55 to +20 (1.3/1.55 μm)	-50 to +7 (1.3 μm)	-65 to -3*10 (1.3 μm)
Measurement accuracy*3	±5%*11	±5%*6,*12	-	±5%*6,*12
Temperature range	0° to 50°C (use), -40° to +70°C (storage)			
Dimensions and mass	30 (W) x 30 (H) x 37 (D) mm, ≤100 g	20 (W) x 20 (H) x 128 (D) mm, ≤300 g	30 (W) x 30 (H) x 37 (D) mm, ≤100 g	

*1: Installed in MS9020A/B/C/D

*2: Specify one connector among those shown in the specification table. When no connector and manufacturer's name are specified, FC-type (Amphenol 905 type for MS0905A) will be mounted and supplied. Other than the connectors indicated in the table are dealt in special connectors of custom-made. The ordering method of optical connectors are indicated in the table on page 39.

*3: Used with FC-type connectors

*4: At -10 dBm, 0.633/0.78/0.85 μm CW light mode

*5: At -10 dBm, 0.66/0.78/0.85 μm CW light mode

*6: At -10 dBm, 0.85/1.3/1.55 μm CW light mode

*7: Installed in MS9020D, applicable connector: SM fiber (ITU-T G.652)

Return loss: ≥40 dB (1.55 ±0.2 μm, only when return loss of optical connector: ≥45 dB)
Polarization dependency: ≤0.1 dB (1.55 ±0.02 μm)

*8: Installed in MS9020D

*9: Used with UV coated SM fiber with a jacket diam. 0.25 mm

*10: 0° to 40°C

*11: At -10 dBm, 1.3/1.55 μm CW light mode

*12: At -10 dBm, 1.55 μm CW light mode, 18° to 28°C

• MS0907A Return Loss Measurement Unit*1

Applicable fiber	SM (10/125 μm, NA 0.1)
Wavelength	1.31 ±0.03 μm (25°C)
Measurement range	0 to 40 dB (relative to total internal reflection cord, including output connector reflection)
Measured data display range	0 to 60 dB (relative to total internal reflection cord, excluding output connector reflection)
Measurement accuracy	±1 dB (relative to the reflection, constant temperature)
Optical output connector*2	FC, ST, DIN, HMS-10/A, SC: PC-type
Temperature range	0° to 50°C (use), -40° to +70°C (storage)
Dimensions and mass	90 (W) x 93 (H) x 36 (D) mm, ≤300 g

*1: Installed in MS9020B/C/D; Laser Product Safety Standards: Class-1 (IEC Pub. 825, FDA 21CFR)

*2: Specify one connector among those shown in the specification table. When no connector and manufacturer's name are specified, FC-type (Amphenol 905 type for MS0905A) will be mounted and supplied. Other than the connectors indicated in the table are dealt in special connectors of custom-made. The ordering method of optical connectors are indicated in the table on page 39.

Safety measures for laser products

The MS0908A complies with the optical safety standards in Class 2 of the IEC pub. 825 and the FDA (21CFR 1040.10, USA); the following descriptive labels are affixed to the product (FDA label is only affixed to product for export to the USA).

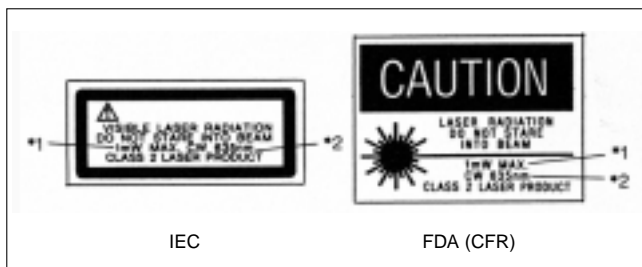

The maximum output is indicated under *1, and the wavelength under *2. Caution: Do not look directly into the laser beam.

MA9722A Optical Sensor



Optical Sensor
(MA9421A/9423A/9621A/
9721A/9723A)



LED Source
(MS0901A/0902A/0903A/
0904A/0904B/0905A/0906A)

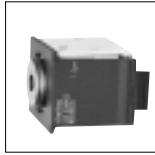

LD Source
(MS0902D/0903D)



Optical sensor
(MA9422A)



LD Source
(MS0908A/0909A)

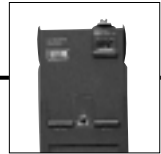

(A photograph
includes a sensor)



MS9020D

Fiber cord with plug

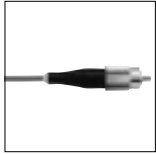

Bare fiber

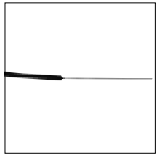

Bare fiber

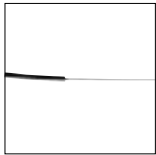

Fiber cord with plug

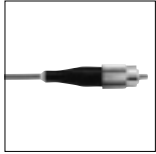

UV coated SM fiber (with a jacket diam. 0.25 mm)

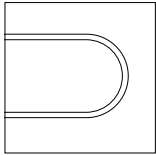

MA9014A

Bare Fiber Connector



Pigtail fiber



MA9013A Fiber Adapter



MA9004A Connector Adapter attached
MA9015A Connector Adapter (MS0905A only)

LED Source
(MS0901A/0902A/0903A/0904A/
0904B/0905A/0906A)

LD Source
(MS0902D/0903D)

FC/SC type (integrated with connector)

Optical Sensor
(MA9421A/9423A/9621A/9721A/9723A)

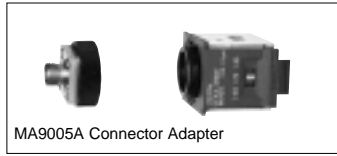

MA9005A Connector Adapter

MA9722A Optical Sensor



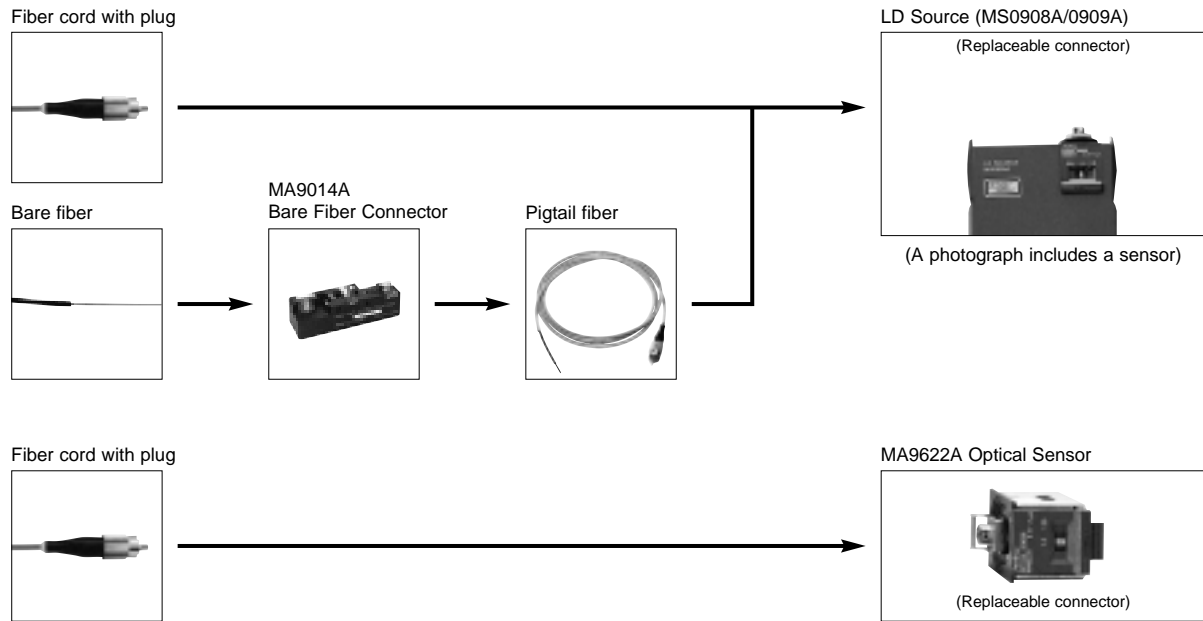

Ordering information

Please specify model/order number, name, and quantity when ordering.

Model/Order No.	Name
MS9020D	Mainframe Optical Loss Test Set (with Ni-Cd batteries)
Z0178	Standard accessories AC adapter: 1 pc Power cord, 2.5 m: 1 pc
J0599	AC operation adapter: 1 pc
J0477	Continuunt adapter: 1 pc
J0441	Total internal reflection cord (for MS0907A only): 1 pc
W1306AE	MS9020D operation manual: 1 copy
	LED sources
MS0901A	LED Source (MA9004A Connector Adapter attached)
MS0902A	LED Source (MA9004A Connector Adapter attached)
MS0903A	LED Source (MA9004A Connector Adapter attached)
MS0904A	LED Source (MA9004A Connector Adapter attached)
MS0904B	LED Source (integrated with connector)
MS0905A	LED Source (MA9015A Connector Adapter attached)
MS0906A	LED Source (MA9004A Connector Adapter attached)
MS0902D	LD Source (integrated with connector)
MS0903D	LD Source (integrated with connector)
MS0908A	LD Source (replaceable connector attached)
MS0909A	LD Source (replaceable connector attached)
	Optical sensors
MA9421A	Optical Sensor
MA9422A	Optical Sensor (thin type)
MA9423A	Optical Sensor
MA9621A	Optical Sensor (MA9005A Connector Adapter attached)
MA9622A	Optical Sensor (for high power, replaceable optical connector attached)
MA9721A	Optical Sensor
MA9722A	Optical Sensor (for fiber identification)
MA9723A	Optical Sensor (MA9005A Connector Adapter attached)
	Optical return loss measuring unit
MS0907A	Optical Return Loss Measuring Unit

Model/Order No.	Name
	Optional accessories
MA9004A	Connector Adapter (for MS0901A/0902A/0903A/0904A/0906A)
MA9005A	Connector Adapter (for MA9421A/9423A/9621A/9721A/9723A)
MA9006A	Sensor Adapter (for optical sensors)
MA9013A	Fiber Adapter (Clad diam. 125 μm; Jacket diam. 0.25 to 1 mm)
MA9014A	Bare Fiber Connector
MA9015A	Connector Adapter (for MS0905A)
MP93A	Fiber Adapter (Clad diam. ≤150 μm)
MP94D	Connector Adapter (used with MP93A)
MZ8013A	Sensor Holder
J0436	Optical sensor cord S (for ML9002A, MS9020A/B/C/D)
J0438	Recorder output cord (mini-jack with clips)
J0200B	FC-FC-2M-GI (FC optical fiber cord, 2 m, GI)
J0056B	FC-FC-2M-SM (FC optical fiber cord, 2 m, SM)
Z0179	Carrying case
Z0180	Battery pack (for Alkali/Manganese cell, up to 4 pcs)
Z0181	Ni-Cd battery pack
Z0182	Soft case (MS0908A/0909A can not house)
Z0426	Carrying case (for MS9020D + MS0908A/0909A)
J0206A	FC-PC-DIA-PC-1M-SM (FC-PC-DIAMOND-PC optical conversion cord, 1 m, SM)
J0208A	FC-BIC-1M-GI (FC-BICONIC optical conversion cord, 1 m, GI)
J0210A	FC-D4-1M-SM (FC-D4 optical conversion cord, 1 m, SM)
J0517A	FC-DIN-1M-SM (FC-DIN optical conversion cord, 1 m, SM)
J0519A	FC-ST-1M-SM (FC-ST optical conversion cord, 1 m, SM)
J0521A	FC-SC-1M-SM (FC-SC optical conversion cord, 1 m, SM)
J0617B	Replaceable connector (FC) *For MA9622A, MS0908A/0909A
J0618D	Replaceable connector (ST) *For MA9622A, MS0908A/0909A
J0618E	Replaceable connector (DIN) *For MA9622A, MS0908A/0909A
J0618F	Replaceable connector (HMS-10/A) *For MA9622A, MS0908A/0909A
J0619B	Replaceable connector (SC) *For MA9622A, MS0908A/0909A
Z0333A	Wavelength selector *For MS0904A/0904B/0906A/0909A
B0232	Blank panel

OPTICAL TIME DOMAIN REFLECTOMETER

MW9076 Series

1.31/1.45/1.55/1.625 μm (SM)

Simple Measurement of Chromatic Dispersion



Features

- 45 dB high dynamic range
- 8 m short dead zone
- Simple measurement of chromatic dispersion from one end of optical fiber
- Measurement in 10 s (Full-Auto mode), 0.15 s real-time sweep
- 5 cm high resolution, 50,000 sampling points
- 8.4 inch TFT-LCD color display

Model	MW9076B1	MW9076B	MW9076C	MW9076D1
Optical fiber	SM	SM	SM	SM
Wavelength	1.31/1.55 μm ±25 nm	1.31/1.55 μm ±25 nm	1.31/1.55/1.625 μm ±25 nm	1.31/1.45/1.55/1.625 μm ±3 nm
Dynamic range	40.5/38.5 dB (typical)	45/43 dB (typical)	41.5/39.5/37 dB	34.5/33.5/32.5/30.0 dB
Dead zone (Fresnel, back-scattered)	1.6/8 m	1.6/8 m	1.6/8 m	3/25 m
Chromatic dispersion				√
Light source function		√	√	
Options	Visible light source	√	√	√
	Optical power meter	√	√	
	High power optical power meter	√	√	√
	Optical channel selector unit	√	√	√
Features	<ul style="list-style-type: none"> • High cost performance • Short dead zone • Low cost 	<ul style="list-style-type: none"> • Highest class model • Wide dynamic range • Short dead zone 	<ul style="list-style-type: none"> • Three wavelengths • L-band measurement 	<ul style="list-style-type: none"> • Chromatic dispersion measurement • Four wavelengths • Wavelength accuracy: ±3 nm

Performance and functions

• High dynamic range

When using a wavelength of 1.55 μm , a point about 190 km distant can be measured.



• Chromatic dispersion characteristics

The zero and total dispersion can be displayed along with the delay, dispersion and dispersion slope at 0.1 nm steps.

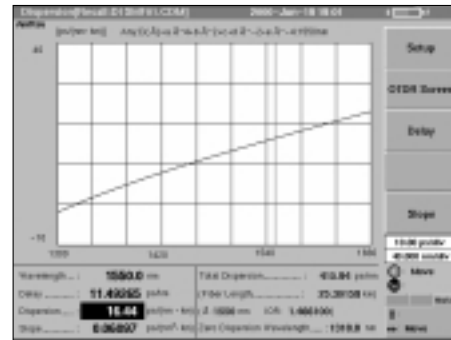

• Short dead zone

Clearly measure up to near end by 8 m dead zone (back-scatter, SM unit)

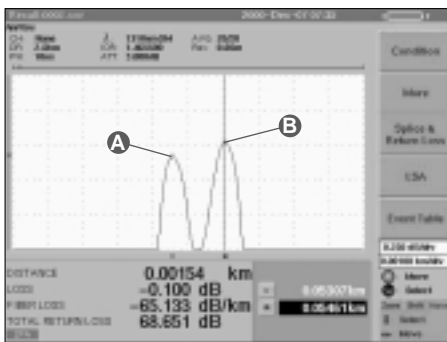
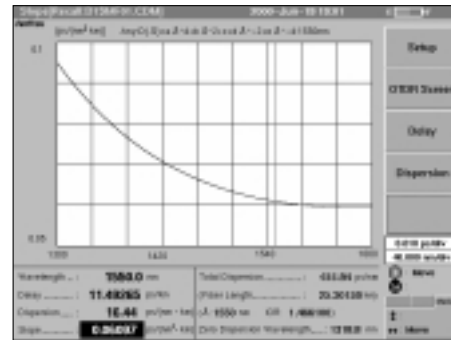
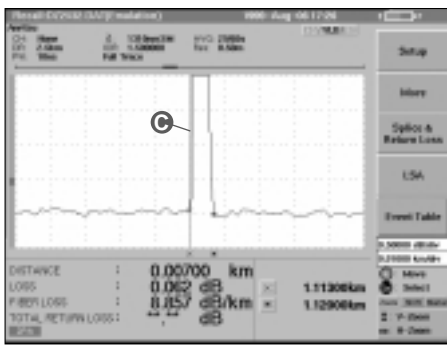

• High-speed measurement

It takes only 10 seconds to measure and display the waveform and connection loss on one screen. Just one press of the Start key is all that is needed to make measurement.

• Full automatic mode

Measurement results are displayed by simply pressing the Start key. All complicated settings of distance range, pulse width, attenuator, and maker can be automatically executed. Measurement speed in this mode was significantly increased. When the wavelengths are set to ALL, wavelengths are automatically changed.

• Repeated measurement

A series of operations, such as measurement, wavelength switching, data saving, optical channel switching, and next optical fiber measurement, can be executed automatically under preset measurement conditions. This mode is ideal for measuring a multi-core optical fiber.

• Waveform comparison function

Measured and saved data can be compared on the same screen. In addition, differences can be displayed as a waveform for simple observation of distance and level differences. This is useful for checking aging changes or comparing several fibers.

• Chromatic dispersion measurement

The MW9076D1 has a built-in function for measuring chromatic dispersion even outdoors. The chromatic dispersion can be measured automatically over a wide range from 1300 to 1660 nm from one end of the fiber. The dispersion reproducibility is $\pm 0.05 \text{ ps}/(\text{nm} \cdot \text{km})^*$ and the dynamic range is 30 dB. The MW9076D1 can be operated from an external PC using remote commands to measure the chromatic dispersion. For detail of the chromatic dispersion measurement, refer to the document of "product introduction MW9076 series Optical Time Domain Reflectometer".

*: Measured with 25 km of 1.3 μm zero-dispersion fiber (ITU-T G.652) at 1550 nm.

• Fresnel reflection

The far-end Fresnel reflection can be measured for four wavelengths (1310/1450/1550/1625 nm).

• Group delay characteristics

The fitting formula supports cubic or quintic Sellmeier, and polynomials can be applied to various types of fibers.

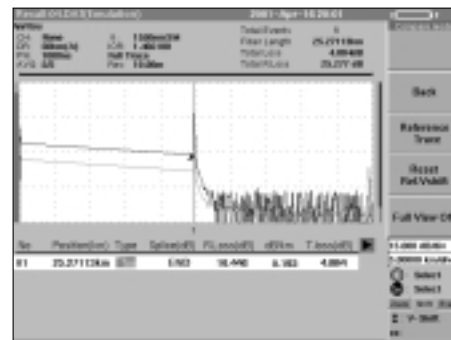

- **Warning level setup function**

In automatic measurement mode, an event warning value can also be set in addition to a detection threshold value. For example, the threshold value can be set to the acceptance level, and warning value to a pass/rejection decision level. In this case, all events will be detected, and those exceeding the warning value are displayed in another color, therefore, enabling the operator to easily identify possible "borderline" events.

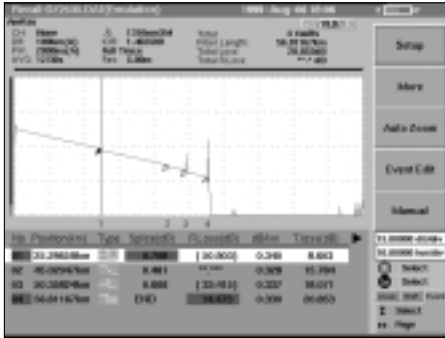

- **Communication light check function**

When measuring a fiber in service, there is a possibility of mis-measurement by an OTDR. To guard against the risk of mis-measurement, this check function checks for the presence of light other than the OTDR optical measurement pulse.

- **Optical channel selector control function**

In addition to using the built-in optical channel selector, external MN9662A/9664A Optical Channel Selector can be controlled via the RS-232C interface from an OTDR. By using these selectors, an optical fibercable consisting of up to 32 cores can be measured automatically.

- **Visible LD**

A 635 nm visible LD option is available for the detection of breaks and loss points along the fiber to be measured.

- **Light source, power meter**

Optical fiber loss can be measured using the optical power meter function and light source function. Two types of optical power meters are supported: One is measurement range of -70 to +3 dBm (MW9076B/B1/C-02 option), the other is measurement range of -50 to +23 dBm (MW9076B/B1/C-03 option).

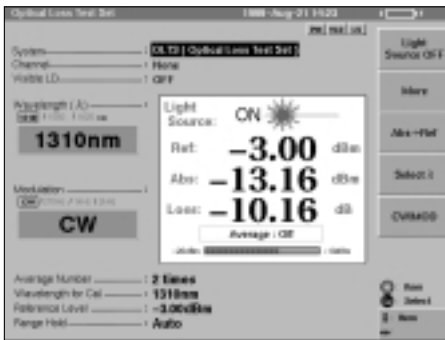

- **VGA output terminal**

The VGA connector outputs the screen interface to a CRT monitor, which is very useful for production-line applications.

- **Large internal memory**

About 18 MB internal memory is provided as standard. The following table shows the number of waveforms which can be saved in each media.

Media	GR196	Analysis
FDD (1.4 MB)	123	67
PC-ATA card (32 MB)	2700	1520
PC-ATA card (256 MB)	16000	10600
Internal memory (18 MB)	1560	860
Hard disk (1 GB)*	32700	32700

Number of data points: 5,000

*: The hard disk is for the PC card slot (IBM Microdrive DSCM-11000 + PC card adapter)

MX907600A OTDR Emulation Software

- **Emulation function**

Measured waveform data can be analyzed using a PC.

- **Data transmission function**

Data files recorded by the MW9076 series can be transferred to a PC via the RS-232C port.

- **Both-end measurement function**

A new waveform can be composed by averaging data measured at both ends of an optical fiber.

Specifications

• Optical Time Domain Reflectometer (main frame)

Model	MW9076B	MW9076C	MW9076B1	MW9076D1
Wavelength	1310/1550 ±25 nm*1	1310/1550/1625 ±25 nm*1	1310/1550 ±25 nm*1	1310/1450/1550/1625 ±3 nm*1
Measurable optical fiber	10/125 μm single-mode optical fiber (ITU-T G.652)			
Optical connector	FC, SC, DIN, HMS-10/A, ST (replaceable, PC type)			
Distance range	1, 2.5, 5, 10, 25, 50, 100, 200, 250, 400 km			
Pulse width	10, 20, 50, 100, 500, 1000, 2000, 4000, 10000, 20000 ns			
Dynamic range*2 (S/N = 1)	42.5 dB (1.31 μm) 40.5 dB (1.55 μm) *Typical value: 45 dB (1.31 μm) 43 dB (1.55 μm)	41.5 dB (1.31 μm) 39.5 dB (1.55 μm) 37 dB (1.625 μm)	38 dB (1.31 μm) 36 dB (1.55 μm) *Typical value: 40.5 dB (1.31 μm) 38.5 dB (1.55 μm)	34.5 dB (1.31 μm) 33.5 dB (1.45 μm) 32.5 dB (1.55 μm) 30.0 dB (1.625 μm)
Dead zone (back-scattered light)*3	≤8 m (1.31 μm) ≤9 m (1.55 μm)	≤8 m (1.31 μm) ≤9 m (1.55 μm) ≤12 m (1.625 μm)	≤8 m (1.31 μm) ≤9 m (1.55 μm)	≤25 m
Dead zone (Fresnel reflection)*4	≤1.6 m	≤1.6 m	≤1.6 m	≤3 m
Marker resolution	0.05 to 800 m			
Sampling resolution	0.05 to 80 m			
Sampling points*5	Quick mode: 5001, 6251 Normal mode: 20001, 25001 High mode: 40001, 50001			
Distance measurement accuracy	±1 m ±3 x measurement distance x 10 ⁻⁵ ± marker resolution (excluding uncertainty caused by fiber IOR)			0.1 m ±3 x measurement distance x 10 ⁻⁵ ± marker resolution (excluding uncertainty caused by fiber IOR)
Loss measurement accuracy (linearity)	±0.05 dB/dB or ±0.1 dB (whichever is greater)			
Return loss measurement accuracy	±2 dB			
Automatic measurement*11	Measurement items: Total loss, total return loss. Each event distance, connection loss, return loss, or reflection amount (displays in table format) Threshold values Connection loss: 0.01 to 9.99 dB (in 0.01 dB steps), Return loss: 20 to 60 dB (in 1 dB steps), Fiber-end: 1 to 99 dB (in 1 dB steps) Warning values Splice connection loss: 0.1 to 10 dB (in 0.01 dB steps), Connector connection loss: 0.1 to 10 dB (in 0.01 steps), Return loss: 10 to 50 dB (in 0.1 dB steps), Fiber loss: 0.1 to 10 dB (in 0.01 steps), Total loss: 0.1 to 60 dB (in 0.1 steps), Total return loss: 10 to 50 dB (in 0.1 dB steps) Number of detected events: Up to 99 Automatic setting: Distance range, pulse width, averaging count (time) Measurement time: ≤60 s (in full automatic measurement mode) Connection check: Automatic check of front panel connector connection quality Communication light check: Check for presence of communication light in optical fiber to be measured			
Manual measurement	Measurement items: Transmission loss and distance between 2 points, loss per unit length between 2 points, connection loss, return loss/ reflection amount, total return loss Real-time sweep: 0.1 to 0.2 second or less*6			
Optical loss measurement light source function	Applicable optical fibers: SM optical fiber (ITU-T G.652), PC polishing Optical connectors: Shared with OTDR (same port) Light-emitting elements: FP-LD Center wavelength: 1310/1550 ±25 nm (MW9076B, CW, 25°C) 1310/1550/1625 ±25 nm (MW9076C, CW, 25°C) Spectrum width: ≤5/10 nm (MW9076B, CW, 25°C) ≤5/10/10 nm (MW9076C, CW, 25°C) Output level accuracy: -3 ±1.5 dBm (CW, 25°C, SM optical fiber: 2 m) Optical output short term stability: ≤0.1 dB [CW, at one point from -10° to +40°C (±1°C), Difference between maximum and minimum values in one min, SM optical fiber cable: 2 m] Output waveform CW, 270 Hz, 1 kHz, 2 kHz (Modulated waves are square waves.) Modulation frequency: 270 Hz/1 kHz/2 kHz ±1.5% Laser safety specification: 21CFR Class 1, IEC 60825-1 Class 1			

Model	MW9076B	MW9076C	MW9076B1	MW9076D1
Chromatic dispersion measurement function		—		Wavelength measurement range: 1300 to 1660 nm Wavelength accuracy: $\pm 0.5 \text{ nm}^{*7}$ Zero dispersion wavelength repeatability: $\pm 0.6 \text{ nm}^{*10}$ Dispersion repeatability (typical): $\pm 0.05 \text{ ps}/(\text{nm} \cdot \text{km})^{*10}$ Dynamic range: 30 dB (4% Fresnel)
Other functions	Waveform storage (Bellcore, SOR or Anritsu, Data format, user selectable), print output (Centronics), repeated measurement function (A series of operations such as wavelength switching, waveform storage, and printing can be executed by pressing a single key.), relative distance set (zero cursor set), calendar clock, distance unit set (km, kf, mi), title input (up to 32 characters), remaining battery power display			
Laser safety specification	21CFR Class 1, IEC Pub 825-1 Class 1			
Power	$\leq 35 \text{ W}$ max. (at charging), 4 W (in standard state, MU250000A power consumption included.)			
Battery	Continuous operation: 6 h (typical value) ^{*8}			
Dimensions and mass	290 (W) x 194 (H) x 30 (D) mm (MW9076B/C main frame) 290 (W) x 194 (H) x 75 (D) mm (MU250000A Display Unit included) $\leq 1.4 \text{ kg}$ $\leq 3.7 \text{ kg}$ (MU250000A display unit and battery pack included)			290 (W) x 194 (H) x 77 (D) mm (MW9076D1 main frame) 290 (W) x 194 (H) x 122 (D) mm (with MU250000A Display Unit) $\leq 3.1 \text{ kg}$ (MW9076D1 main frame only), $\leq 5.4 \text{ kg}$ (with MU250000A Display Unit and battery pack included)
Environmental condition	Operating temperature and humidity: -10° to 40°C , $\leq 85\%$ (no condensation) Storage temperature and humidity: -20° to 60°C , $\leq 85\%$ Vibration: Conforming to MIL-T-28800E Class 3 Shock: 76 cm height, 6 surfaces, 8 corners ^{*9} Dust-proofing: MIL-T-28800E Drip-proofing: MIL-T-28800E			
EMC	EN61326: 1997/A1, 1998 (Class A) EN61000-3-2: 1995/A2, 1998 (Class D) EN61326: 1997/A1, 1998 (Annex A)			
LVD	EN610101-1: 1993/A2, 1995 (Installation Category II, Pollution Degree 2)			

- *1: At 25°C, pulse width: 1 μs
- *2: At 25°C, pulse width: 20 μs , averaging time: 180 s
- *3: Pulse width: 10 ns, return loss: 40 dB (Refer to the figure right)
- *4: Pulse width: 10 ns (Refer to the figure right)
- *5: Either value is automatically selected in each mode, depending on the distance range.
- *6: At quick mode
- *7: Compared value with internal wavelength data at chromatic dispersion measurement
- *8: At back light low brightness, measurement not executed.
- *9: Dropped on the floor of plywood (thickness 5 cm) fixed by concrete. Not applicable to the MW9076D1
- *10: Measured with 25 km of 1.3 μm zero-dispersion fiber (ITU-T G.652) at 1550 nm.
Not an error from absolute value but repeatability of measured results. Contact Anritsu Corporation in case of measuring ITU-T G.655 fiber.
- *11: Automatic measurement is a supporting function which enables to operate easier, it doesn't assure results. As there is a case of miss detection, please check a waveform data, either.

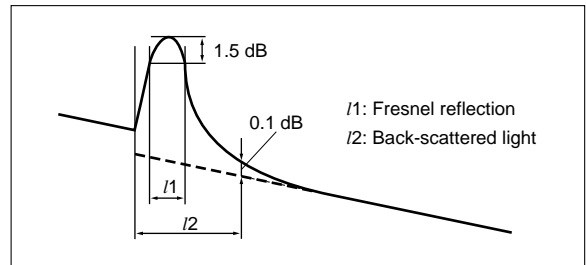

Note: MW9076D1 can accept a special wavelength request. Please consult us.

• **MU250000A/A1/A4 Display Unit**

Display	MU250000A Unit: 8.4 inch color, TFT-LCD (640 x 480 pixels, transparent type, with back light) MU250000A1 Unit: 7.2 inch color, STN-LCD (640 x 480 pixels, semi-transparent type, with back light on/off) MU250000A4 Unit: 7.8 inch color, STN-LCD (640 x 480 pixels, reflective type, with front light on/off)
Interface	Serial interface: RS-232C-1 (115.2 kbps max.), with D-sub 9-pin connector RS-232C-2 (57.6 kbps max.), with mini-DIN 8-pin connector Printer interface: 8-bit parallel interface (Centronics), with D-sub, 25-pin connector Keyboard interface: IBM US ENGLISH (101 keys) 106 keys compatible, with mini-DIN 6-pin connector VGA output connector: Mini-DIN 10-pin connector
FDD	Built-in 3.5 inch (1.44 MB/720 kB)
Power supply	10 to 26.4 Vdc 100 to 250 Vac (rated), 50/60 Hz, ≤50 VA max. (Specific AC adapter is used.) Battery: CGR-B/802 Lithium ion battery pack can be used. (mounted in main frame)
Power	≤35 W
Dimensions and mass	290 (W) x 194 (H) x 45 (D) mm, ≤1.9 kg
Environmental conditions	Restricted by memory card specifications when a memory card is mounted. AC adapter: Depend on the conditions of AC adapter Operation temperature and humidity: -10° to +40°C, ≤85% (no condensation), +5° to 40°C, ≤80% (FDD is used.) Storage temperature and humidity: -20° to 60°C, ≤85% Vibration: Conform to MIL-T-28800E Class 3 Shock: 76 cm height, 6 surfaces, 8 corners* Dust proofing: Conform to MIL-T-28800E Drip proofing: Conform to MIL-T-28800E
EMC	Same as MW9076 series
LVD	Same as MW9076 series

*: Dropped on the floor of plywood (thickness 5 cm) fixed by concrete

• **Battery pack: CGR-B/802D**

Battery	Lithium ion secondary battery
Voltage, capacity	14.4 V, 2550 mAh (36.72 Wh)
Continuous drive time	See the MW9076 series specifications
Charging time	≤3 h
Dimensions and mass	134.5 (W) x 89.5 (H) x 20.5 (D) mm, ≤390 g

• **AC adapter: ADP60WB24.0**

Rated AC input	100 to 240 Vac, 50/60 Hz
Rated DC output	24 Vdc, 2.5 A
Dimensions and mass	109.5 x 62.5 x 31 mm, ≤350 g
Safety specifications	UL, CSA, TUV, CE, AS
Environmental conditions	Operating temperature and humidity: 0° to +40°C, 80% Storage temperature and humidity: -20° to +80°C, 90%

• **Visible light source: MW9076B/B1/C/D1-01**

Central wavelength	635 ±15 nm (at 25°C)
Optical output	-3.0 ±1.5 dBm
Output optical fiber	10/125 μm, SM (ITU-T G.652)
Optical connector	FC, SC, ST, DIN, DIAMOND (HMS-10/A) *Replaceable
Optical safety	IEC Pub 60825-1 Class 2, 21CFR Class 2
Environmental conditions	Same as MW9076 series
EMC	Same as MW9076 series
LVD	Same as MW9076 series

Safety measures for laser products

This option complies with optical safety standards in Class 2 of the IEC pub. 60825-1 and the FDA (21CFR1040.10, USA); the following descriptive labels are affixed to the product (FDA labels is only affixed to product for export to the USA).

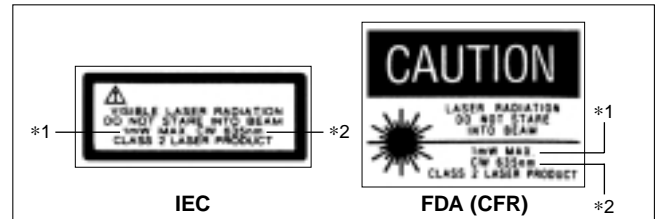

The maximum output is indicated under *1, and the wavelength under *2.
Caution: Do not look directly into the laser beam.

• **Optical power meter: MW9076B/B1/C-02, MW0976B/B1/C-03**

Applicable optical fiber	10/125 μm, SM (ITU-T G.652)
Optical connector	FC, SC, ST, DIN, DIAMOND (HMS-10/A) *Replaceable
Wavelength range	1.2 to 1.7 μm
Measurement range	Option 02: +3 to -70 dBm (continuous light) 0 to -73 dBm (modulated light) Option 03: +23 to -50 dBm (continuous light) +20 to -53 dBm (modulated light)
Measurement accuracy	Option 02: ±5% (-30 dBm, 1.31/1.55 μm, continuous light) Option 03: ±5% (-10 dBm, 1.31/1.55 μm, continuous light)
Environmental conditions	Same as MW9076 series
EMC	Same as MW9076 series
LVD	Same as MW9076 series

• **MU960001A/960002A Optical Channel Selector Unit**

Model	MU960001A	MU960002A
Configuration	1 x 4	1 x 8
Wavelength range	1.2 to 1.65 μm (The special wavelength are 1.31/1.55 μm.)	
Optical fiber	10/125 μm, SM (ITU-T G.652)	
Optical connector	FC, SC, ST, DIN, DIAMOND (HMS-10/A) *Replaceable	
Insertion loss	≤2.5 dB	≤4.5 dB
Environmental conditions	Same as MW9076 series (not applicable to the shock)	
Dimensions	290 (W) x 194 (H) x 47 (D) mm	
Mass	≤1.5 kg	≤2.0 kg
EMC	Same as MW9076 series	
LVD	Same as MW9076 series	

*MU960001A/MU960002A can not be attached to MW9076D1.

Ordering information

Please specify model/order number, name and quantity when ordering.

Model/Order No.	Name
	Optical Time Domain Reflectometer (main frame, requires display unit)
MW9076B	SMF 1.31/1.55 μm OTDR
MW9076B1	SMF 1.31/1.55 μm OTDR
MW9076C	SMF 1.31/1.55/1.625 μm OTDR
MW9076D1	SMF 1.31/1.45/1.55/1.625 μm OTDR
	Standard accessories (main frame)
W1659AE	MW9076 series operation manual: 1 copy
W1660AE	MW9076 series serial interface manual: 1 copy
	Connector adapter*1: 1 pc
Z0404A	Lithium ion battery pack: 1 pc
	Units
MU250000A	Display Unit (8.4 inch TFT-LCD)
MU250000A1	Display Unit (7.2 inch STN-LCD)
MU250000A4	Display Unit (7.8 inch STN-LCD)
	Standard accessories (display unit)
ADP60WB24.0	AC adapter
Z0402	Front cover
O979	A-2 power cord*2 (for Japan)
J0980	A-2 power cord*2 (for USA, Canada, Taiwan)
J0981	B4 power cord*2 (for UK, Malaysia, South Africa, Hong Kong)
J0982	C7 power cord*2 (for Europe)
J0983	S3 power cord*2 (for Oceania, China)
Z0403A	Belt with hook
MU960001A	Optical Channel Selector Unit (1 x 4 channels, with connector adapter*1)
MU960002A	Optical Channel Selector Unit (1 x 8 channels, with connector adapter*1)
	Battery pack
Z0404A	Lithium ion battery pack
	Software
MX907600A	OTDR Emulation Software
	Options
MW9076B/B1/C/D1-01	Visible light source*7
MW9076B/B1/C-02	Optical power meter*3, *4, *7
MW9076B/B1/C-03	High power optical power meter*3, *4, *7
MW9076B/B1/C-04	Delete battery pack
MW9076B/C-25	FC-APC connector*7
MW9076B/C-26	SC-APC connector*7
MW9076B/B1/C/D1-37	FC-PC connector
MW9076B/B1/C/D1-38	ST connector
MW9076B/B1/C/D1-39	DIN connector
MW9076B/B1/C/D1-40	SC connector
MW9076B/B1/C/D1-43	DIAMOND (HMS-10/A) connector
MW9076B/C-47	HRL-10 connector*7
MU960001A-37	FC-PC connector
MU960002A-37	FC-PC connector
MU960001A-38	ST connector
MU960002A-38	ST connector
MU960001A-39	DIN connector
MU960002A-39	DIN connector
MU960001A-40	SC connector
MU960002A-40	SC connector
MU960001A-43	DIAMOND (HMS-10/A) connector
MU960002A-43	DIAMOND (HMS-10/A) connector

Model/Order No.	Name
	Application parts
Z0301A	Keyboard (requires mini-DIN conversion adapter)
JT8MA3-NT1	PC-ATA card (8 MB)
JT16MA3-NT1	PC-ATA card (16 MB)
JT32MA3-NT1	PC-ATA card (32 MB)
JT64MA3-NT1	PC-ATA card (64 MB)
JT128MA3-NT1	PC-ATA card (128 MB)
JT256MA3-NT1	PC-ATA card (256 MB)
JT512MA3-NT1	PC-ATA card (512 MB)
J0057	Optical adapter FC type
J0635□*8	Optical fiber cord [with FC-PC at both ends (SM)]
B0442	Soft carrying case [440 (W) x 310 (H) x 110 (D) mm]
Z0435	Soft carrying case [430 (W) x 300 (H) x 170 (D) mm]
Z0436	Hard carrying case (holds main frame and thermal printer)
J0617B	Replaceable optical connector (FC)
J0618D	Replaceable optical connector (ST)
J0618E	Replaceable optical connector (DIN)
J0618F	Replaceable optical connector (HMS-10/A, HFS-13/A)
J0619B	Replaceable optical connector (SC)
J0441	Total internal reflection cord (SM)
J1039	Total internal reflection cord (SC-PC)
J1040A	1.31/1.55 LWPF filter cord (FC-PC), 1 m
J1040B	1.31/1.55 LWPF filter cord (FC-PC), 2 m
J1041A	1.31/1.55 LWPF filter cord (SC-PC), 1 m
J1041B	1.31/1.55 LWPF filter cord (SC-PC), 2 m
J0654A	Serial interface cord (for remote control with IBM-PC/AT or J-310, 9 pin-9 pin)
J0655A	Serial interface cord (for PC-98 remote control, 9 pin-25 pin)
J0977	Serial interface cord (for connection with external optical channel selector)
Z0434	Mini-DIN conversion adapter (for keyboard, Z0301A)
J0978	VGA conversion cable (for external monitor)
J1041A	1.31/1.55 LWPF filter cord (SC · PC), 1 m
	Peripherals
BL-80R2	High speed thermal printer
BL-100W	AC adapter (for BL-80R2, AC 100 to 240 V)
DPU-414-31B	Thermal printer*5
PW-4007-U1	AC adapter*5
DPU-414-31B	Thermal printer*6
PW-4007-E1	AC adapter*6
J0614	Printer connection cable (for DPU-414)
	Supplies
BL-80-30	Printer paper (for BL-80R2 thermal printer, 10 rolls/set)
TP411-28CL	Printer paper (for DPU-414 Thermal printer, 10 rolls/set)

*1: Specify one of FC, ST, DIN, SC or DIAMOND. When the connector type is not specified, FC-PC is supplied.

*2: Specify one of A-2, B4, C7 or S3.

*3: The optical power meter (Option 02) and high-level-input optical power meter (Option 03) cannot be mounted at the same time.

*4: The optional optical power meter and high-level-input optical power meter cannot be set for MW9076D1.

*5: 108 to 132 V, 60 Hz, 0° to +40°C, Seiko products (printer cable: sold separately)

*6: 207 to 253 V, 50 Hz, 0° to +40°C, Seiko products (printer cable: sold separately)

*7: Factory option

*8: Specify the optical fiber length as A, B or C (A: 1 m, B: 2 m, C: 3 m)

OPTICAL TIME DOMAIN REFLECTOMETER
MW9060A

1.31/1.55 μm (SM), 0.85/1.3 μm (GI)

For High-Accuracy Measurement of Optical Fiber Cables



The MW9060A is an upgraded version of the high-performance MW9040A/B OTDR. Anritsu's unique procedure and event-registration functions combine to reduce measurement time. The new unit also incorporates a 3.5 inch FDD and printer.

This is a universal type OTDR to be used for single mode or multimode fiber in a wide dynamic range for long distance or in a high-resolution for short distance.

There are 2 types of wide dynamic range plug-in units in the single mode (1.31 μm, 1.31/1.55 μm) whose dynamic ranges are 34 dB, 32 dB, and 34/32 dB, respectively. The long-distance optical fibers can be measured with high efficiency. There are also 2 types of high-resolution plug-in unit, one is in single mode (1.31/1.55 μm) and the other is in multimode (0.85/1.30 μm). A single mode unit realizes near-end dead zone of 8 m (MW0944B high-resolution unit), and a multimode fiber unit realizes the zone of 3 m, thus making possible for fault detection from the near end.

Features

- For long- and short-haul, and single-mode and multimode fiber
- Fast 0.3-s sweep speed (FAST mode, 2PA mode)
- Procedure and event registration functions shorten measurement time
- Printer and 3.5 inch FD/PMC drives as standard equipment
- Return loss measurement

Functions and Performance

• Measurement of long optical fibers

The MW0945B/0947B plug-in units have a dynamic range of 34/32 dB or better (1.31/1.55 μm), for measuring long optical fibers of 180 km or more. A measurement example for a long optical fiber with a transmission loss of 0.18 dB/km (1.55 μm) is shown below.

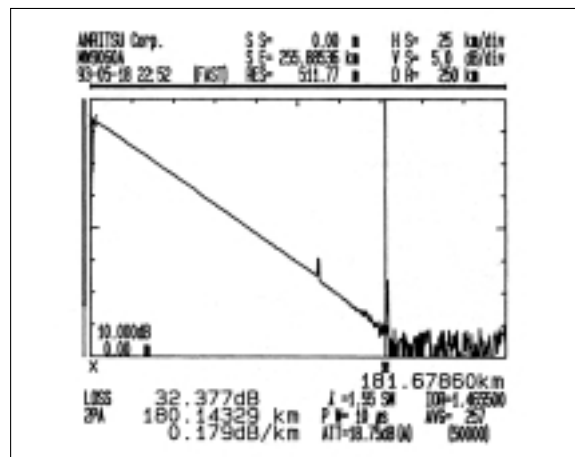

• High-resolution measurements

The MW0944B plug-in unit has a spatial resolution of less than 2 m and a near-end dead zone of less than 8 m, making it useful for detecting faults in short optical fibers used in buildings, etc.

• Built-in high-speed printer

The image displayed on the screen can be printed in about 7 seconds at 73.1 x 57.1 mm. Averaging continues even during printing and the unit also responds to key input during printing, so there is no need to wait for printing to finish.

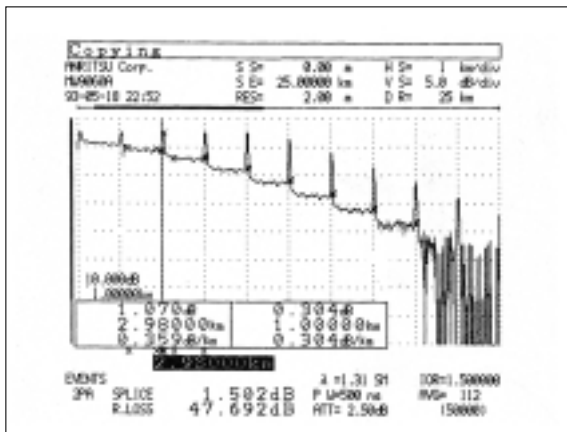

Copy example using event function

• PMC and FD drives

With a 512 KB PMC, 248 measured waveform screens can be recorded. The FDD uses the MS-DOS[®] format, so recorded data can be read on a PC. Up to 700 measured waveform screens can be recorded on one 2HD floppy disk. PMCs offer better durability than floppy disks and are very reliable even in dusty and hot environments.
*: MS-DOS is a registered trademark of Microsoft Corporation.

• Direct-plot function

Direct printing to an external printer or plotter is possible using the GPIB interface.

• Unique procedure and event registration functions

The procedure function can be used to assign operation procedures to function keys. The same operation can then be repeated just by pressing the assigned function key. In addition, event markers can be set at any point to be measured; when the LASER-ON key is pressed, the measured results are displayed in an event table according to the marker settings.

Specifications

• MW9060A (main frame)

Sweep speed	Min. 0.3 s/sweep (used in fast sweep mode and 2PA mode)	
Automatic search	No. of search points: Max. 5 points (at event mode off), max. 100 points (at event mode on) Threshold (dB): 0.05, 0.1, 0.3, 1.0, 3.0, 5.0	
Optical return loss measurement	Provided	
Waveform comparison	Displays 2 waveforms simultaneously	
Smoothing function	Improves the S/N ratio of the waveform by 6 levels from level 1 through level 6	
Full-trace display function	Display the full measurement trace, measured by switching each attenuator in turn	
Relative distance measurement function	Display distance relative to cursor setting	
Event function	Fiber length, total loss, transmission loss, return loss for fiber on either side of splice point	
Procedure function	Key command sequence is recorded and assigned to a single key for automatic execution.	
Built-in memory	32 waveforms (store the setting conditions at the same time)	
Memory card	Plug-in memory card, 32/64/128/256/512 KB (option)	
Floppy disk*1	Micro Floppy disk, storage capacity (MS-DOS ^{®2} formatted), 2 MB/1 MB (1.44 MB/720 KB) or 1.6 MB/1 MB (1.2 MB/720 KB)	
Printer	Hard copy of screen display is available by line thermal printer.	
Title display	20 characters x 2 lines	
Index of refraction (IOR)	1.400000 to 1.699999 (in 0.000001 steps)	
Distance display units	Meters, feet, miles	
CRT	6-inch, green	
Interface	GPIB	Conforms to IEE-488.1 and IEEE-488.2 Device mode: SH1, AH1, T6, L4, SR1, RL1, PP0, DC1, DT1, C0, E2 Controller mode: SH1, AH1, T6, L4, SR1, RL1, PP0, DC1, DT1, C4, C7, E2
	Direct plot	Hard copy of the measurement screen to an external plotter/printer is available through GPIB.
Power supply	85 to 132 (170 to 250) Vac, 50/60 Hz ±5%, ≤160 VA	
Temperature and humidity*3	-10° to +55°C (operate), -20° to +60°C (storage), ≤80%	
Dimensions and mass	284 (W) x 177 (H) x 450 (D) mm, ≤12.5 kg (without plug-in units)	
EMC	EN61326: 1997/A1, 1998 (Class A) EN61000-3-2: 1995/A2, 1998 (Class A) EN61326: 1997/A1, 1998 (Annex A)	
LVD	EN610101-1: 1993/A2, 1995 (Installation Category II, Pollution degree 2)	

*1: 1 MB/1.6 MB (720 KB/1.2 MB) capability available as option
720 KB/1.44 MB: When formatting the IBM-PC series (IBM is a registered trademark of International Business Machines Corporation)
720 KB/1.2 MB: When formatting the PC-9800 series (PC-9800 series is a product of NEC.)

*2: MS-DOS is a registered trademark of Microsoft Corporation.

*3: When plug-in memory cards (PMC) are used, the operating temperature is:
PMC left inserted: -10° to +55°C
Inserting/removing PMC: 0° to +55°C
Operating temperature when floppy disk and printer are used: +5° to +35°C

• **MW0944B high-resolution unit**

Wavelength*1		1310/1550 nm ±15 nm				
Fiber under measurement		10/125 μm single-mode fiber (ITU-T G.652)				
Optical connector*2		FC-PC, DIAMOND-PC, ST-PC, DIN-PC, SC-PC				
Pulse width		10 ns	20 ns	100 ns	500 ns	2 μs
Dynamic range (one-way back-scattered light level)*3,*4	Effective	6.5/4.0 dB	8.0/5.5 dB	11.5/9.0 dB	15.0/12.5 dB	18.0/15.5 dB
	SNR=1	9.5/7.0 dB	11.0/8.5 dB	14.5/12.0 dB	18.0/15.5 dB	21.0/18.5 dB
Dynamic range (4% Fresnel reflection)*4	Effective	34.5/33.0 dB				
	SNR=1	37.5/36.0 dB				
Near-end dead zone*5,*6	Fresnel reflection	3 m	5 m	13 m	55 m	220 m
	Back-scattered light	8 m	10 m	20 m	65 m	240 m
Spatial resolution*5,*7	Fresnel reflection	2 m	4 m	13 m	55 m	220 m
	Back-scattered light	2 m	4 m	15 m	60 m	220 m
Mask function*5,*8	No. of masks	5 max. (optical)				
	Mask width	13 m	13 m	18 m	65 m	240 m
Variable near-end mask width		Provided				
Variable optical output power function*8		Provided				
Distance range (km)*5		10, 25, 50, 100				
Horizontal axis*5	Scale (m/div)	2.5, 5, 10, 25, 50, 100, 250, 500, 1 km (10 km range) 2.5, 5, 10, 25, 50, 100, 250, 500, 1 km, 2.5 km (25 km range) 2.5, 5, 10, 25, 50, 100, 250, 500, 1 km, 2.5 km, 5 km (50 km range) 2.5, 5, 10, 25, 50, 100, 250, 500, 1 km, 2.5 km, 5 km, 10 km (100 km range)				
	Resolution	Sampling resolution: 5 cm to 20 m Read-out resolution: 5 cm to 200m				
	Accuracy	±1 m ±measured value (m) x 2 x 10 ⁻⁵ (does not include uncertainty in fiber index of refraction)				
Vertical axis	Scale (dB/div)	0.1, 0.25, 0.5, 1, 2.5, 5				
	Read-out resolution	0.001 dB				
	Linearity	±0.05 dB/dB				
Ambient temperature		0° to +35°C (spec. meet), -10° to +60°C(storage)				
Mass		≤2.5 kg				

• **MW0945B/0947B wide dynamic range unit**

Wavelength*1		1310 nm ±15 nm											
Fiber under measurement		10/125 μm single-mode fiber (ITU-T G.652)											
Optical connector*9		FC, DIAMOND, ST, DIN, SC											
Pulse width		20 ns	100 ns	500 ns	1 μs	4 μs	10 μs	20 ns	100 ns	500 ns	1 μs	4 μs	10 μs
Dynamic range (one-way back-scattered light level)*3,*4	Effective	15 dB	20 dB	23 dB	26 dB	31 dB	34 dB	13 dB	18 dB	21 dB	24 dB	29 dB	32 dB
	SNR=1	18 dB	23 dB	26 dB	29 dB	34 dB	37 dB	16 dB	21 dB	24 dB	27 dB	32 dB	35 dB
Dynamic range (4% Fresnel reflection)*4	Effective	35 dB	39 dB	41 dB	42 dB	44 dB	45 dB	34 dB	38 dB	40 dB	41 dB	43 dB	44 dB
	SNR=1	38 dB	42 dB	44 dB	45 dB	47 dB	48 dB	37 dB	41 dB	43 dB	44 dB	46 dB	47 dB
Near-end dead zone*5,*6	Fresnel reflection	35 m	50 m	95 m	200 m	700 m	1500 m	35 m	50 m	95 m	200 m	700 m	1500 m
	Back-scattered light	35 m	50 m	95 m	200 m	700 m	1500 m	35 m	50 m	95 m	200 m	700 m	1500 m
Spatial resolution*5,*7	Fresnel reflection	15 m	30 m	75 m	150 m	500 m	1500 m	15 m	30 m	75 m	150 m	500 m	1500 m
	Back-scattered light	30 m	50 m	90 m	200 m	700 m	1500 m	30 m	50 m	90 m	200 m	700 m	1500 m
Mask function*5,*8	No. of masks	5 max. (optical)											
	Mask width	75 m	75 m	150 m	200 m	700 m	1500 m	75 m	75 m	150 m	200 m	700 m	1500 m
Variable optical output power function*8		Provided											
Distance range (km)*5		10, 25, 50, 100, 250											
Horizontal axis*5	Scale (m/div)	5, 10, 25, 50, 100, 250, 500, 1 km (10 km range) 5, 10, 25, 50, 100, 250, 500, 1 km, 2.5 km (25 km range) 5, 10, 25, 50, 100, 250, 500, 1 km, 2.5 km, 5 km (50 km range) 5, 10, 25, 50, 100, 250, 500, 1 km, 2.5 km, 5 km, 10 km (100 km range) 5, 10, 25, 50, 100, 250, 500, 1 km, 2.5 km, 5 km, 10 km, 25 km (250 km range)											
	Resolution	Sampling resolution: 10 cm to 50 m, Read-out resolution: 10 cm to 500 m											
	Accuracy	±1 m ±measured value (m) x 2 x 10 ⁻⁵ (does not include uncertainty in fiber index of refraction)											
Vertical axis	Scale (dB/div)	0.1, 0.25, 0.5, 1, 2.5, 5											
	Read-out resolution	0.001 dB											
	Linearity	±0.03 dB/dB											
Ambient temperature		-10° to +55°C (spec. meet), -40° to +75°C (storage)											
Mass		≤2.5 kg											

• MW0967B high-resolution unit

Wavelength*1		850/1300 nm ±15 nm				
Fiber under measurement*10		50/125 μm GI multimode fiber (NA0.2) *ITU-T G.651				
Optical connector*11		FC, DIAMOND, ST, DIN, SC				
Pulse width		5 ns	20 ns	100 ns	500 ns	2 μs
Dynamic range one-way back-scattered light level*3,4	Effective	9.0/7.0 dB	12.0/10.0 dB	15.5/13.5 dB	19.0/17.0 dB	21.5/20.0 dB
	SNR = 1	12.0/10.0 dB	15.0/13.0 dB	18.5/16.5 dB	22.0/20.0 dB	24.5/23.0 dB
Dynamic range (4% Fresnel reflection)*4	Effective	27/29 dB	29/31 dB			
	SNR = 1	30/32 dB	32/34 dB			
Near-end dead zone*5,6	Fresnel reflection	1.5 m	1.5 m	1.5 m	1.5 m	1.5 m
	Back-scattered light	3 m	4.5 m	15 m	60 m	220 m
Spatial resolution*5,7	Fresnel reflection	2 m	4 m	15 m	60 m	220 m
	Back-scattered light	2 m	4 m	15 m	60 m	220 m
Mask function		Not provided				
Variable optical output power function		Provided				
Distance range (km)*5		10, 25, 50, 100				
Horizontal axis*5	Scale (m/div)	2.5, 5, 10, 25, 50, 100, 250, 500, 1 km (10 km range) 2.5, 5, 10, 25, 50, 100, 250, 500, 1 km, 2.5 km (25 km range) 2.5, 5, 10, 25, 50, 100, 250, 500, 1 km, 2.5 km, 5 km (50 km range) 2.5, 5, 10, 25, 50, 100, 250, 500, 1 km, 2.5 km, 5 km, 10 km (100 km range)				
	Resolution	Sampling resolution: 5 cm to 20 m Read-out resolution: 5 cm to 200 m				
	Accuracy	±1m ±measured value (m) × 2 × 10 ⁻⁵ (does not include uncertainty fiber index of refraction)				
Vertical axis	Scale (dB/div)	0.1, 0.25, 0.5, 1, 2.5, 5				
	Readout resolution	0.001 dB				
	Linearity	±0.05 dB/dB				
Ambient temperature		-10° to +55°C (spec. meet), -40° to +75°C (storage)				
Mass		≤2.5 kg				

*1: Not applicable in the variable optical output power mode

*2: Please specify one of these types when ordering. Please contact us for other connectors. (However, the dynamic range is degraded by 0.5 dB for DIAMOND and D4 connectors.)

*3: Dynamic range (one-way back-scattered light)

Effective: The difference between the level of the point which is 0.3 dB higher than the peak noise level and the level of the point where near-end back-scattering occurs. SNR=1: The level difference between the RMS noise level and the level where near end back-scattering occurs.

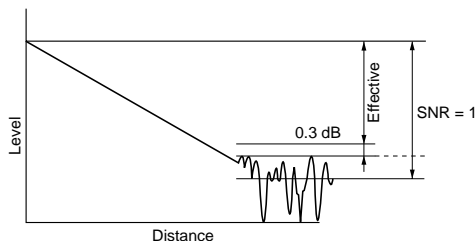

*4: Values are obtained using smoothing (level 6). With no smoothing, all values are reduced by 2 dB.

*5: When the index of refraction is set to 1.500000.

*6: Near-end dead zone

Fresnel reflection: The minimum distance at which the 4% Fresnel reflection generated by the fault can be detected. (MW0944B with built-in variable optical output power function used.)

Back-scattered light: The near-end dead zone (for back-scattered light) is the distance at which the near-end back-scattered light level approaches ±0.5 dB of its final value. — For the MW0944B: This specification represents the values for the FC-PC connector (when return loss ≥25 dB). When a fiber with an FC connector (flat polished) is measured, the dead zone may be larger than the specified value. The variable near-end mask width function can be used to suppress dead zone widening to 2 to 3 m.

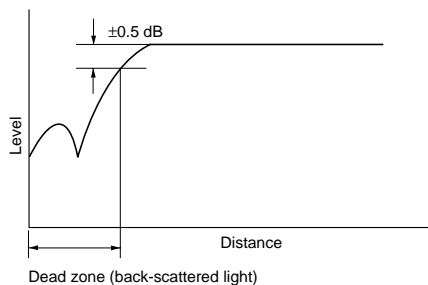

*7: Spatial resolution

Fresnel reflection: The width of an unsaturated Fresnel reflection pulse at the point that is 1.5 dB less than the peak value.

Back-scattered light: The distance between the points where the beginning and ending levels at a splice etc. (≤1 dB) are within ±0.1 dB of their initial and final values, respectively.

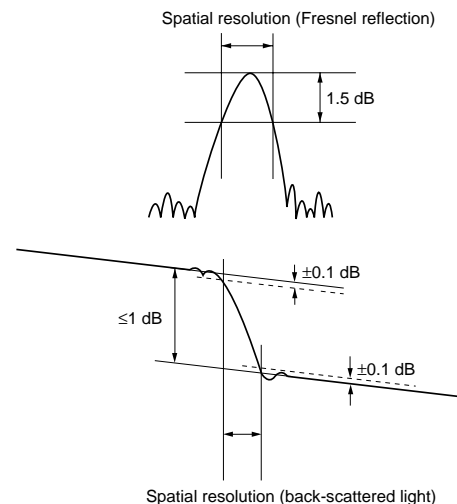

*8: All masks including the near-end mask (except MW0945B and MW0947B) are OFF in the variable optical output mode.

*9: Please specify one of these types when ordering. Please contact us for other connectors. (However, the dynamic range is degraded by 0.5 dB for DIAMOND, D4, and AT&T Biconic connectors.)

*10: The dynamic range is increased by about 1.5 dB when measuring 62.5/125 μm (NA 0.29) fibers. The transmission loss measurement result may differ from that obtained with NA 0.29 by as much as 0.1 dB/km.

*11: Please specify one of these types when ordering. Please contact us for other connectors.

Ordering information

Please specify model/order number, name, and quantity when ordering.

Model/order No.	Name
MW9060A	Main frame Optical Time Domain Reflectometer
MW0944B	Plug-in units SMF 1.31/1.55 μm Unit (short distance, high resolution)
MW0945B	SMF 1.31 μm Unit (long distance, wide-dynamic range measurement)
MW0947B	SMF 1.31/1.55 μm Unit (long distance, wide-dynamic range measurement)
MW0967B	GIF 0.85/1.30 μm Unit (short distance, high resolution)
	Standard accessories (main frame)
	Power cord, 2.5 m: 1 pc
F0013	Fuse, 5 A: 2 pcs
Z0240	Thermal roll paper (2 rolls/set): 2 sets
W0667AE	MW9060A operation manual: 1 copy
	Standard accessory (plug-in unit)
B0346	Unit adapter (for unit installation): 1 pc/1 unit
	Options (main frame)
MW9060A-01	GPIO interface
MW9060A-02	1.2 MB FDD (conforming to NEC PC-9800 series format)
	Options (plug-in unit)
MW09[][]-21	D4 connector
MW09[][]-22	AT&T Biconic connector (unavailable for the MW0944B)
MW0967B-23	Amphenol 906
MW09[][]-37	FC-PC connector (unavailable for the MW0944B/0967B)

Model/order No.	Name
	Optional accessories
B0293	CRT hood
P0005	Memory card (RAM: 32 KB)
P0006	Memory card (RAM: 64 KB)
P0007	Memory card (RAM: 128 KB)
P0008	Memory card (RAM: 256 KB)
P0009	Memory card (RAM: 512 KB)
J0007	GPIO cable, 1 m
J0008	GPIO cable, 2 m
J0057	Optical adapter, FC type
J0200[*]	FC-FC-[*]M-GI (FC optical fiber cord, [*] m, GI)
J0056[*]	FC-FC-[*]M-SM (FC optical fiber cord, [*] m, SM)
J0087[*]	FC-D4-[*]M-GI (FC-D4 optical conversion cord, [*] m, GI)
J0210[*]	FC-D4-[*]M-SM (FC-D4 optical conversion cord, [*] m, SM)
J0209[*]	FC-BIC-[*]M-GI (FC-BICONIC optical conversion cord, [*] m, GI)
J0208[*]	FC-BIC-[*]M-GI (FC-BICONIC optical conversion cord, [*] m, GI)
J0207[*]	FC-DIA-[*]M-GI (FC-DIAMOND optical conversion cord, [*] m, GI)
J0206[*]	FC-PC-DIA-PC-[*]M-SM (FC-PC-DIAMOND-PC optical conversion cord, [*] m, SM)
J0516[*]	FC-DIN-[*]M-GI (FC-DIN optical conversion cord, [*] m, GI)
J0517[*]	FC-DIN-[*]M-SM (FC-DIN optical conversion cord, [*] m, SM)
J0518[*]	FC-ST-[*]M-GI (FC-ST optical conversion cord, [*] m, GI)
J0519[*]	FC-ST-[*]M-SM (FC-ST optical conversion cord, [*] m, SM)
J0520[*]	FC-SC-[*]M-GI (FC-SC optical conversion cord, [*] m, GI)
J0521[*]	FC-SC-[*]M-SM (FC-SC optical conversion cord, [*] m, SM)
B0329K	Protective cover (for front panel)
B0350	Carrying case (hard type)
Z0245	Carrying case for plug-in unit (hard type)
Z0246	Carrying case for plug-in unit (soft type)
	Peripherals
MA9014A	Bare Fiber Connector (common use for SM and GI fiber)
MA9013A	Fiber Adapter
FP-850	Printer (EPSON product)
VP-870	Printer (EPSON product)
HP7550A	Plotter (HP product)
	Supplies
Z0168	3.5 inch mini floppy disk (2HD): 10 pcs/set
Z0054	3.5 inch mini floppy disk (2DD): 10 pcs/set

[*]: These lengths are expressed by symbols A, B and C in the order number, for example; J0200A, B or C, where A = 1 m, B = 2 m, C = 3 m.

OPTICAL SPECTRUM ANALYZER
MS9710C
 600 to 1750 nm

High Performance for DWDM Optical Communications

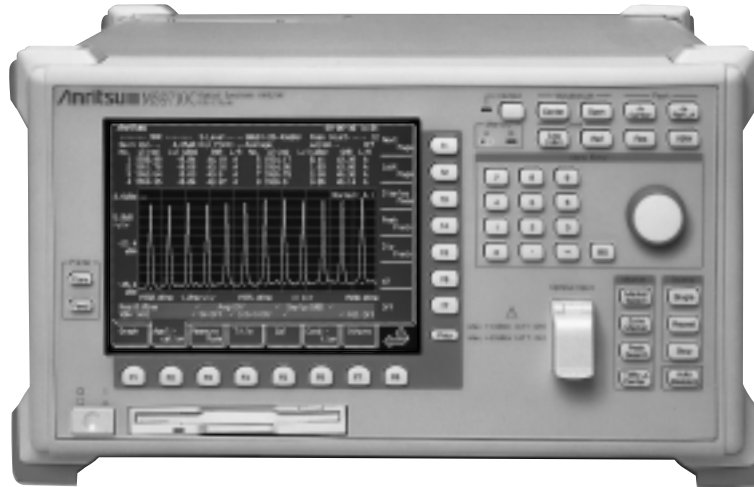

The MS9710C is a diffraction-grating spectrum analyzer for analyzing optical spectra in the 600 to 1750 nm wavelength band. In addition to uses such as measurement of LD and LED spectra, it has functions for measuring the transmission characteristics of passive elements such as optical isolators, as well as NF/Gain of optical fiber amplifier systems.

In addition to its basic features, the superior stability and reliability of the diffraction grating (patent pending) offer the severe level and wavelength specifications particularly in the WDM band.

This analyzer has the dynamic range, reception sensitivity, and sweep speed requested by users, backed by Anritsu's high-level technology. The high sensitivity meets the exacting demands placed on today's measuring instruments. In particular, the excellent wavelength and level specifications fully meet the dense WDM requirements (1520 to 1620 nm).

The MS9710C Optical Spectrum Analyzer is the successor to the popular MS9710B but with improved functions and higher performance. The specifications have been upgraded for the important 1.55 μm band for WDM communications and have also been optimized to include the new requirements for L-band (1570 to 1620 nm) use. In addition to the high reliability and excellent basic performance, this analyzer has a full range of application functions to support accurate measurement in the fastest possible time.

Features

- Wavelength accuracy of ±20 pm (C-band) and ±50 pm (L-band)
- Dynamic range of 42 dB (0.2 nm from peak wavelength), 70 dB (1 nm from peak wavelength)
- WDM measurement of wavelength, level, and SNR for up to 128 channels

Performance and applications

• 70 dB dynamic range

The dynamic range at 0.2 nm from the peak wavelength is better than 42 dB and is a high 58 dB min. at 0.4 nm from the peak, permitting high-accuracy measurement of DWDM systems with a 50 GHz (0.4 nm) channel spacing. The analyzer demonstrates its excellence in SNR measurement of WDM light sources, as well as in evaluation of narrow-band optical band pass filters.

Distance from peak wavelength	0.2 nm	0.4 nm	1 nm
Normal dynamic range mode	42 dB (45 dB typical)	58 dB	62 dB
High dynamic range mode	42 dB (45 dB typical)	60 dB	70 dB

High-dynamic range measurement example with DFB-LD spectrum passed via narrow-band Band-Pass Filter (BPF).

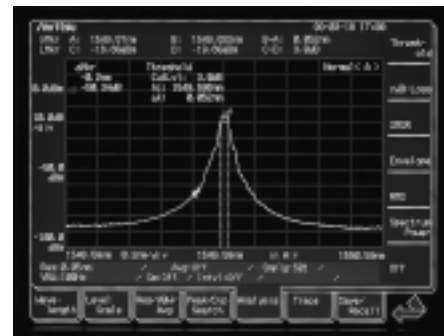
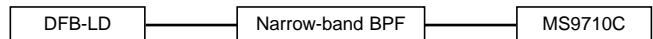

• Relying on WDM transmission

As a result of the need for increased transmission capacity, R&D into large-capacity transmission techniques is becoming more active, and Wavelength Division Multiplexing (WDM) is now in use. This WDM transmission technology requires quantitative measurement of the signal quality and wavelength transmission characteristics of each channel.

Measuring instruments for this purpose require highly-accurate wavelength and level measurements. Furthermore, accurate measurement of fiber-amplifier NF requires extremely good polarization dependant loss characteristics and level linearity specifications.

The MS9710C design achieves excellent wavelength and level specifications for this purpose in the 1520 to 1620 nm wavelength band and also in the extended band (L-band) to 1620 nm. In particular, the wavelength accuracy can be calibrated automatically using an optional internal reference wavelength light source; the post-calibration accuracy is better than ±20 pm.

Specifications for WDM application

Mainframe, option	MS9710C	With Option 15*2
Wavelength accuracy*1	±20 pm (1530 to 1570 nm) ±50 pm (1520 to 1600 nm)	±20 pm (1520 to 1620 nm)
Wavelength resolution	50 pm (FWHM of internal optical BPF)	
Resolution accuracy	≤±3% (1530 to 1570 nm, resolution: 0.2 nm)	≤±3% (1520 to 1620 nm, resolution: 0.2 nm)
Level flatness to wavelength	±0.1 dB (1530 to 1570 nm) ±0.3 dB (1520 to 1620 nm)	±0.1 dB (1520 to 1620 nm)
Polarization dependency	±0.05 dB (1550/1600 nm)	
Level linearity	±0.05 dB (1550 nm)	±0.05 dB (1550/1600 nm)
	-50 to 0 dBm (ATT: off), -30 to +20 dBm (ATT: on)	

*1: After calibration with optical reference wavelength light source

*2: L-band enhancement

Full function lineup

In addition to its excellent basic functions, the MS9710C comes with a full lineup of other useful functions summarized in the following table.

Device analysis	For analyzing and evaluating waveforms of optical devices (DFB-LDs, FP-LDs, LEDs)
Waveform analysis	For waveform analysis by RMS and threshold methods; SMSR, half-width evaluation, WDM waveform analysis
Application measurement	EDFA NF and gain measurement, polarization mode dispersion measurement
Modulation, pulsed light measurement	Max. frequency range (VBW) = 1 MHz
Markers	Multimarkers: Marker function for max. 300 points Zone markers: For waveform analysis within zone Peak/dip search: Searches for a peak or dip
Power monitor	Also functions an optical power meter
Vacuum wavelength display	Converts displayed wavelength to value in vacuum
External interfaces	GPIB, RS-232C, VGA monitor output

• 3.5 inch internal FDD

In addition to saving and recalling measurement data, etc., waveforms saved to floppy disk can be easily and directly read by a personal computer.

The PC screen shown on the right is displaying an image of the MS9710C screen saved to floppy disk. Screen images can be saved to FD media and output as Windows® bitmap-format files. In addition, since the data can be output in text-file format, it can be manipulated easily using spreadsheet software.

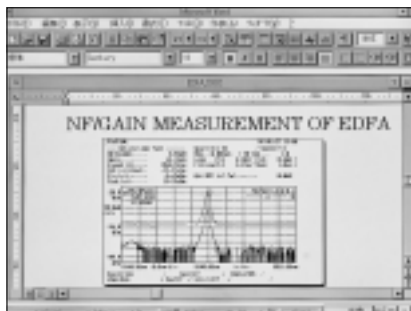

• Spectrum analysis for WDM communication systems

The wavelength, level, and SNR of up to 300 WDM channels can be analyzed.

A new noise level left/right average function (shown below) has been added to a SNR measurement. In addition, the noise level is normalized to a per nm figure. Accurate SNR measurement can be achieved due to the high-resolution accuracy of the MS9710C.

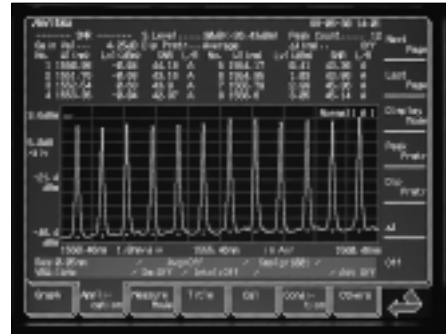

The measurement results described above can be switched to a table display that can be saved and recalled in text format. Both the wavelength and frequency are shown in the table.



• NF measurement of fiber amplifier (EDFA)

NF measurement by the optical method using an optical spectrum analyzer measures the light input to and output from the EDFA. NF is determined by the beat noise between the optical signal and the Amplified Spontaneous Emission (ASE) from the EDFA as well as by the beat noise between the ASE.

Since the MS9710C measures the ASE level with very high accuracy, three methods can be used to measure NF: 1. Pulse measurement (JIS: under discussion), 2. Level calibration using fitting, and 3. Polarization nulling. Moreover, measurement can be performed with the required dynamic range, level linearity, and polarization dependency.

* This analyzer is available as the ME7890B Optical Amplifier Test System (using a pulse method) in combination with the MF9619C Optical Modulator and a personal computer, to give the best system for measuring WDM signals with the smallest possible error.



- **Convenient light source option, including reference wavelength light source for better accuracy**

Any one of the SLD light source & Reference wavelength light source (Option 13), SLD light source (Option 14), Reference wavelength light source (Option 05), and White light source (Option 02) can be installed in the MS9710C.

The block diagram of the SLD light source & Reference wavelength light source option is shown below. This option has two separate output ports: Port 1 for wavelength calibration, and the Port 2 for measuring transmission characteristics. When the MS9710C is calibrated automatically by inputting the reference wavelength light source, post-calibration wavelength accuracy in the 1520 to 1620 nm range is better than ± 20 pm (Option 15). This is very useful in precision absolute measurement of the wavelengths of light sources used in WDM systems.

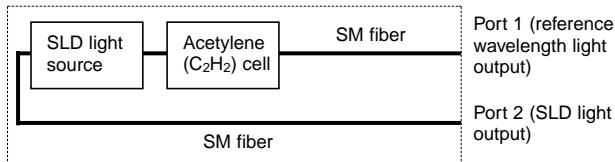

Block diagram of SLD light source & Reference wavelength light

The following diagram shows the spectrum of the SLD light source output from Port 2.

When this light source is used instead of the earlier white light source for measurement of the wavelength transmission characteristics of optical receiver elements, it is possible to achieve a 20 dB wider dynamic range.

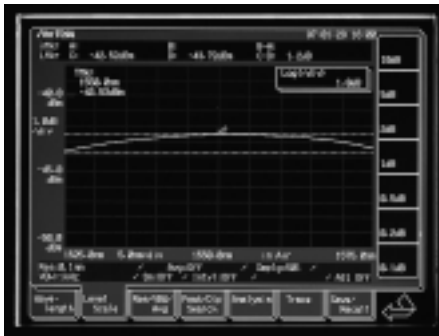

Spectrum of SLD light

The following figure is a measurement example of the transmission characteristics of an optical band pass filter using the SLD light source.



Measurement of optical bandpass filter

If this dynamic range is not required, a lower-cost white light source can be installed instead.

- **Tracking function with tunable laser source**

As shown below, by connecting the TLS of MG9541A and the MS9710C with an RS-232C cable, tracking operation is achieved. This setup provides an optical scalar network analyzer without an external controller. It is very convenient for measuring the wavelength transmission characteristics of optical components with a wide dynamic range.

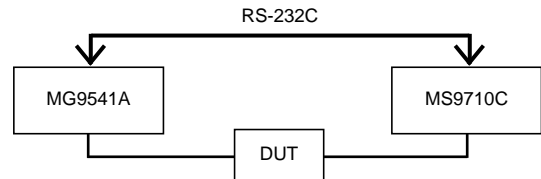

Measurement is performed using the MS9710C soft keys; the analyzer's marker, trace, and smoothing functions permit easy analysis of measurement results, including transmission loss, full width half maximum (FWHM), and stop-band loss characteristics. Screens A and B below show measurement examples for a dielectric filter with a center wavelength of 1540 nm. Screen A shows the FWHM measurement; since the wavelength repeatability is better than ± 7 pm, the FWHM can be measured with very high accuracy. Screen B shows the pass band and stop band loss characteristics. Measurement is possible with a wide dynamic range of better than 70 dB when the MS9710C resolution bandwidth is set 0.2 nm.



Screen A: FWHM measurement example

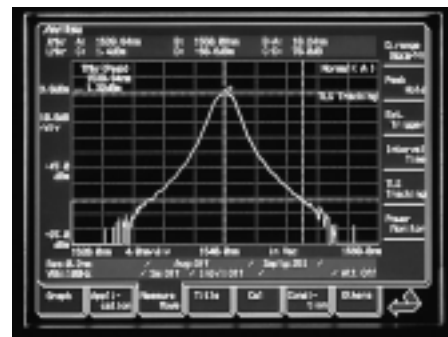

Screen B: Wide dynamic range measurement example

- **VGA output connector**

A VGA output connector is provided on the rear panel of the MS9710C for displaying the measurement screen on an external monitor.

Specifications

Main frame, option	MS9710C	With Option 15 (L-band enhancement)		
Applicable optical fiber	10/125 μm SM fiber (ITU-T G.652)			
Optical connector*1	User replaceable (FC, SC, ST, DIN, HMS-10/A), factory option (E2000, FC-APC, SC-APC, HRL-10)			
Wavelength	Measurement range	600 to 1750 nm		
	Accuracy	±20 pm (1530 to 1570 nm)*2, ±50 pm (1520 to 1600 nm)*2		
		±200 pm (1530 to 1570 nm)*3, ±300 pm (600 to 1750 nm)*3		
	Stability	±5 pm		
	Linearity	±20 pm (1530 to 1570 nm)		
	Resolution	0.05, 0.07, 0.1, 0.2, 0.5, 1.0 nm (RBW: 3 dB optical filter; transmission bandwidth)		
	Read resolution	5 pm		
Resolution*4	≤±2.2% (1530 to 1570 nm, resolution: 0.5 nm) ≤±3% (1530 to 1570 nm, resolution: 0.2 nm) ≤±7% (1530 to 1570 nm, resolution: 0.1 nm) ≤±4% (1520 to 1530 nm, 1570 to 1620 nm, resolution: 0.5 nm) ≤±5% (1520 to 1530 nm, 1570 to 1620 nm, resolution: 0.2 nm) ≤±10% (1520 to 1530 nm, 1570 to 1620 nm, resolution: 0.1 nm)	≤±2.2% (1520 to 1620 nm, resolution: 0.5 nm) ≤±3% (1520 to 1620 nm, resolution: 0.2 nm) ≤±7% (1520 to 1620 nm, resolution: 0.1 nm)		
	≤±7% (1600 to 1520 nm, 1620 to 1750 nm, resolution: 0.5 nm) ≤±15% (1600 to 1520 nm, 1620 to 1750 nm, resolution: 0.2 nm) ≤±30% (1600 to 1520 nm, 1620 to 1750 nm, resolution: 0.1 nm)			
Level	Measurement range	-65 to +10 dBm (600 to 1000 nm, 0 to +30°C, optical ATT: off) -85 to +10 dBm (1000 to 1250 nm, 0 to +30°C, optical ATT: off) -90 to +10 dBm (1250 to 1600 nm, 0 to +30°C, optical ATT: off) -75 to +10 dBm (1600 to 1700 nm, 0 to +30°C, optical ATT: off) -55 to +10 dBm (1700 to 1750 nm, 0 to +30°C, optical ATT: off) -60 to +10 dBm (600 to 1000 nm, +30 to +50°C, optical ATT: off) -80 to +10 dBm (1000 to 1250 nm, +30 to +50°C, optical ATT: off) -85 to +10 dBm (1250 to 1600 nm, +30 to +50°C, optical ATT: off) -70 to +10 dBm (1600 to 1700 nm, +30 to +50°C, optical ATT: off) -50 to +10 dBm (1700 to 1750 nm, +30 to +50°C, optical ATT: off) -70 to +23 dBm (1100 to 1600 nm, 0 to +30°C, optical ATT: on) -65 to +23 dBm (1100 to 1600 nm, +30 to +50°C, optical ATT: on) [Resolution: ≥0.07 nm, VBW: 10 Hz, sweep average: 10 times]		
	Accuracy	±0.4 dB (1300/1550 nm, input: -23 dBm, resolution: ≥0.1 nm)		
	Stability	±0.02 dB (1 min, resolution: ≥0.1 nm, input: -23 dBm, no polarization fluctuation)		
	Flatness	±0.1 dB (1530 to 1570 nm, resolution: 0.5 nm, optical ATT: off) ±0.3 dB (1520 to 1620 nm, resolution: 0.5 nm, optical ATT: off)	±0.1 dB (1520 to 1620 nm, resolution: 0.5 nm, optical ATT: off)	
	Linearity	±0.05 dB (1550 nm, -50 to 0 dBm, optical ATT: off)	±0.05 dB (1550/1600 nm, -50 to 0 dBm, optical ATT: off)	
		±0.05 dB (1550 nm, -30 to +20 dBm, optical ATT: on)	±0.05 dB (1550/1600 nm, -30 to +20 dBm, optical ATT: on)	
Polarization dependency	±0.05 dB (1550/1600 nm), ±0.1 dB (1300 nm) *Setting resolution: ≥0.5 nm			
Dynamic range*5	High-dynamic range mode (20° to 30°C): 70 dB (1 nm from peak wavelength), 60 dB (0.4 nm from peak wavelength), 42 dB (0.2 nm from peak wavelength) Normal mode (20° to 30°C): 62 dB (1 nm from peak wavelength), 58 dB (0.4 nm from peak wavelength), 42 dB (0.2 nm from peak wavelength)			
Optical return loss	≥35 dB (1300/1550 nm)			
Sweep	Sweep width: 0, 0.2 to 1200 nm Sweep speed (typical)*6 : 0.5 s (normal dynamic mode, sweep width: 500 nm, VBW: 10 kHz, center wavelength: 1200 nm, sweep start to stop, no optical input, sampling point: 501)			
Display	6.4 inch, color TFT-LCD			
Memory	A/B (2 trace), 3.5 inch FDD (for MS-DOS® format)			
Printer	Internal (thermal type)			
Interface	GPIO, RS-232C, VGA output			
Operating conditions	Operating temperature: 0° to +50°C (FDD: +5° to +50°C), storage temperature: -20° to +60°C, Relative humidity: ≤90% (no condensation, FDD: 20 to 80%) Shock: 30 G, 11 ms pulse, half sine			
Power	85 to 132 Vac/170 to 250 Vac, 47.5 to 63 Hz, 150 VA (max.)			
Dimensions and mass	320 (W) x 177 (H) x 350 (D) mm, ≤16.5 kg			
EMC	EN61326: 1997/A1, 1998 (Class A) EN61000-3-2: 1995/A2, 1998 (Class A) EN61326: 1997/A1, 1998 (Annex A)			
LVD	EN610101-1: 1993/A2, 1995 (Installation Category II, Pollution degree 2)			

*1: One of these connector is attached. Please specify when ordering.

*2: After WI cal (ref) at wavelength reference optical light source (Option 05/13)

*3: After WI cal (Ext) at DFB-LD and soon external optical light source

*4: Actual screen resolution, 0° to 30°C

*5: Setting resolution: 0.05 nm, wavelength: 1550 nm, optical attenuator: off

*6: Typical value for reference; not guaranteed specification

VBW, sweep speed, minimum light reception sensitivity*1

VBW	10 Hz	100 Hz	1 kHz	10 kHz	100 kHz	1 MHz
Sweep speed (typ)	30 s	5 s	0.5 s	0.5 s	0.5 s	0.5 s
Minimum light reception sensitivity*2	-90 dBm	-80 dBm	-70 dBm	-60 dBm	-50 dBm	-40 dBm

*1: Data for reference (501 points no averaging; not guaranteed specifications (except tracking with MG9541A))

*2: RMS noise level (1250 to 1600 nm)

Note: Warm-up the MS9710C for about 5 min. to ensure stable operation. The above specifications were obtained 2 hours after power-on.

White light source (Option 02)

Optical output	≥-59 dBm/nm (multimode fiber input)*1
Wavelength range	900 to 1600 nm
Operating temperature	18° to 28°C

*1: -65 dBm (typ) measured with MS9710C (at 1 nm wavelength resolution) which has single-mode fiber at the input.

Wavelength reference light source (Option 05)

Wavelength reference	1530 nm band Acetylene
----------------------	------------------------

Wavelength Reference & SLD light source (Option 13)

Wavelength range	1450 to 1650 nm
Output level	>-40 dBm/nm (1550 nm ±10 nm) >-60 dBm/nm (1450 to 1650 nm)
Output level stability*1	±0.04 dB (MS9710C setting resolution: 1 nm, no polarization change, constant temperature, measured for 20 min at 1550 nm)
Spectrum half width	>70 nm (typical: 90 nm)
Optical connector	User replaceable type (FC, SC, ST, DIN, HMS-10/A)
Operating temperature	0° to 40°C
Wavelength reference	1530 nm band Acetylene

*1: Measured after one hour warm-up

SLD light source (Option 14)

Wavelength range	1450 to 1650 nm
Output level	>-40 dBm/nm (1550 nm ±10 nm) >-60 dBm/nm (1450 to 1650 nm)
Output level stability*1	±0.04 dB (MS9710C setting resolution: 1 nm, no polarization change, constant temperature, measured for 20 min at 1550 nm)
Spectrum half width	>70 nm (typical: 90 nm)
Optical connector	User replaceable type (FC, SC, ST, DIN, HMS-10/A)
Operating temperature	0° to 40°C

*1: Measured after one hour warm-up

Ordering information

Please specify model/order number, name, and quantity when ordering.

Model/Order No.	Name
	Main frame
MS9710C	Optical Spectrum Analyzer
	Standard accessories
	Optical connector adapter*1: 1 pc
	Power cord, 2.5 m: 1 pc
F0012	Fuse, 3.15 A (for 100/200 Vac system): 2 pcs
Z0312	Printer paper: 2 rolls
W1579AE	MS9710C operation manual: 1 copy
W1580AE	Remote control operation manual: 1 copy
MX971003S	LabVIEW® driver (RS-232C): 1 pc
MX971003G	LabVIEW® driver (GPIB): 1 pc
B0329G	Front cover: 1 pc
	Options
MS9710C-02	White light source*2
MS9710C-05	Wavelength reference light source*2
MS9710C-13	Wavelength reference & SLD light source*2
MS9710C-14	SLD light source*2
MS9710C-15	L-band enhancement
MS9710C-25	FC-APC connector*3
MS9710C-26	SC-APC connector*3
MS9710C-27	E2000 (Diamond) connector*3
MS9710C-37	FC connector*4
MS9710C-38	ST connector*4
MS9710C-39	DIN connector*4
MS9710C-40	SC connector*4
MS9710C-43	HMS-10/A (Diamond) connector*4
MS9710C-47	HRL-10 connector*3
	Application parts
J0654A	RS-232C cable (9P-9P)
J0655A	RS-232C cable (9P-25P)
J0007	GPIB cable, 1 m
J0617B	Replaceable optical connector (FC)
J0618D	Replaceable optical connector (ST)
J0618E	Replaceable optical connector (DIN)
J0618F	Replaceable optical connector (HMS-10/A)
J0619B	Replaceable optical connector (SC)
J0635B	FC-PC · FC-PC 2M-SM (FC-PC optical fiber cord, 2 m, SM)
Z0282	Ferrule cleaner
Z0283	Replacement reel for ferrule cleaner (for Z0282)
Z0284	Cleaner for optical adapter (stick type)
B0336C	Hard carrying case
G0084A	Polarization rotation module (for PMD measurement)
B0330C	Tilt stand

*1: Specify the connector to be supplied as the standard connector when ordering the above options. If the connector is not specified, the FC connector (MS9710C-37) is supplied as standard.

*2: Factory options; Two units cannot be installed simultaneously. Exchangeable-type optical connectors (FC, SC, ST, DIN, HMS-10/A) are supplied when specified at ordering. One conversion cord is supplied for connecting other optical connectors to the FC connector.

*3: Factory option

*4: User replaceable

MS-DOS® is a registered trademark of Microsoft Corporation.

LabVIEW® is a registered trademark of National Instruments.

OPTICAL SPECTRUM ANALYZER
MS9710B
 600 to 1750 nm

For Evaluating LED/LD Spectra and Transmission Characteristics of Passive Elements

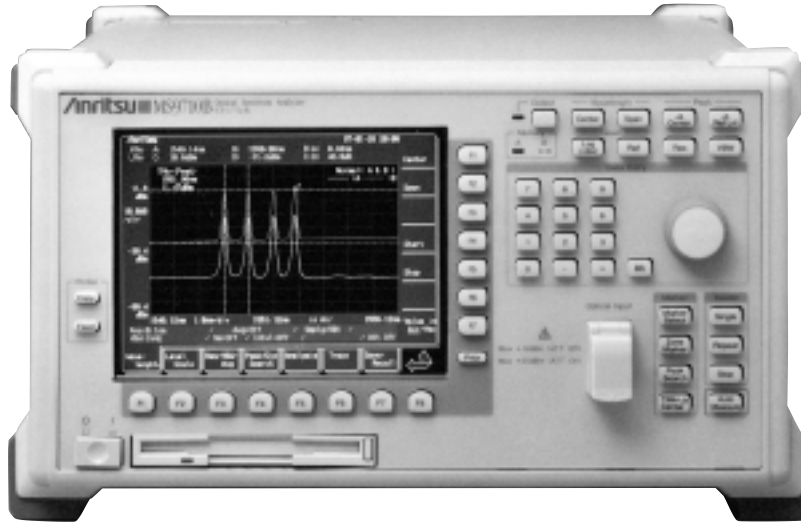

The MS9710B is a diffraction-grating spectrum analyzer for analyzing optical spectra in the 600 to 1750 nm wavelength band. In addition to uses such as measurement of LD and LED spectra, it has functions for measuring the transmission characteristics of passive elements such as optical isolators, as well as the NF/Gain of optical fiber systems.

In addition to its basic features, the superior stability and reliability of the diffraction grating (patent pending) easily pass the severe specifications required for precise measurement of WDM communications methods, particularly in the 1.55 μm band. This analyzer has the dynamic range, reception sensitivity, and sweep speed requested by users, backed by Anritsu's high-level technology. The high sensitivity meets the exacting demands placed on today's measuring instruments. In particular, the excellent wavelength and level specifications fully meet the dense WDM requirements in the 1.55 μm band.

In addition to having a much wider dynamic range, its compact portability (approx. 50% lighter) eliminates the large cumbersome image of earlier analyzers by perfectly combining portability with high performance. In addition to the high reliability and excellent basic performance, this analyzer has a full range of application functions to support accurate measurement in the fastest possible time.

Features

- 70 dB dynamic range
- -90 dBm guaranteed optical reception sensitivity
- Internal 3.5 inch FDD (Windows®)
- Tracking with tunable laser source
- Optical pulse measurement
- Full range of WDM application functions

Performance and functions

• 70 dB dynamic range

The measurement dynamic range of the MS9710B in the normal measurement mode at a wavelength 1 nm from the peak wavelength is 62 dB. In the high dynamic range measurement mode, better than 70 dB can be achieved. The analyzer demonstrates its excellence in SMSR measurement of DFB-LDs, as well as in evaluation of narrow-band optical band pass filters. (See top screen in adjoining column.)

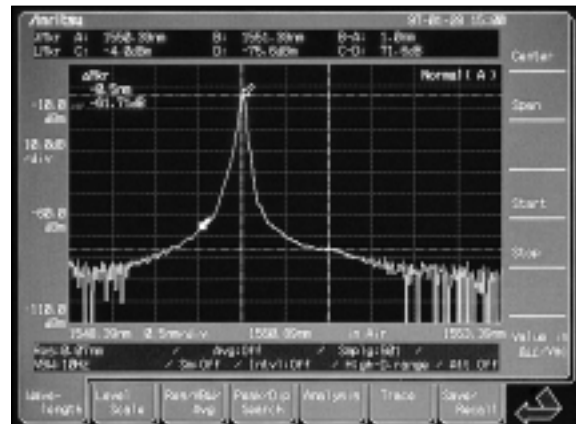

• -90 dBm guaranteed optical reception sensitivity

The MS9710B has achieved an improved S/N over a wide range by taking thorough countermeasures to noise and stray light. The RMS noise level at wavelengths from 1250 to 1600 nm is -90 dBm max. The screen display below is the waveform obtained when measuring a 1.55 μm DFB-LD optical source of -85 dBm; only 25 seconds are required for the measurement. In addition, the S/N can be improved using sweep averaging.

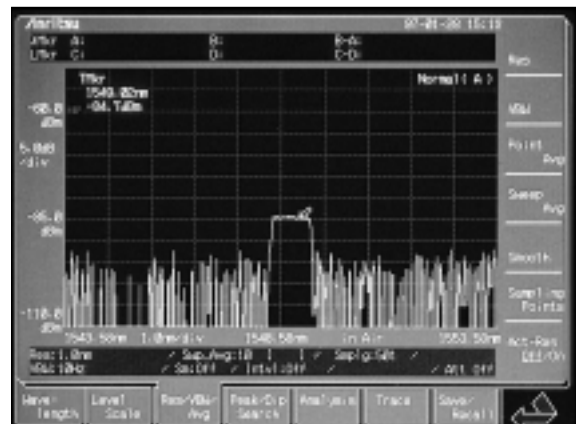

• Full function lineup

In addition to its excellent basic functions, the MS9710B comes with a full lineup of other useful functions summarized in the following table.

Device analysis	For analyzing and evaluating waveforms of optical elements (DFB-LDs, FP-LDs, LEDs)
Waveform analysis	For waveform analysis by RMS and threshold methods; SMSR, half-width evaluation, WDM waveform analysis
Application measurement	EDFA NF and gain measurement, PMD measurement (See applications.)
Modulation, pulsed light measurement	Max. frequency range (VBW) = 1 MHz
Markers	Multimarkers: Marker function for max. 128 points (See applications.) Zone markers: For waveform analysis in zone Peak/dip search: Searches for a peak or dip
Power monitor	Also functions as optical power meter
Vacuum wavelength display	Converts displayed wavelength to value in vacuum
External interfaces	GPIB, RS-232C

• Relying on 1.55 μm transmission band

As a result of the need for increased transmission capacity, R&D into large-capacity transmission techniques is becoming more active and wavelength division multiplexing (WDM) is ready to use. This WDM transmission technology requires quantitative measurement of the wavelength transmission characteristics between each channel. Measuring instruments for this purpose require more accurate wavelength and level measurement. Furthermore, accurate measurement of fiber-amplifier NF requires extremely good polarized light dependency and level linearity specifications. The MS9710B design has achieved excellent wavelength and level specifications for this purpose in the 1.53 to 1.57 μm wavelength band. In particular, the wavelength accuracy can be calibrated automatically using an optional internal reference wavelength light source — the post-calibration accuracy is better than ±0.05 nm. Evaluation of WDM systems requires measurement without repeated calibration at each measurement and the MS9710B achieves high-accuracy measurement with high repeatability.

Applications

• Spectrum analysis for WDM communication system

The wavelength characteristics for the gain, and signal to noise ratio (SNR) between each channel are difficult problems in WDM transmission technology. In evaluation, it is very important to measure this quantitatively. The MS9710B permits extremely quick and simple waveform analysis of up to 300 spectra. The waveform and level (SNR) of each peak exceeding the set threshold is displayed. The screen display below shows an example of the tilt gain.

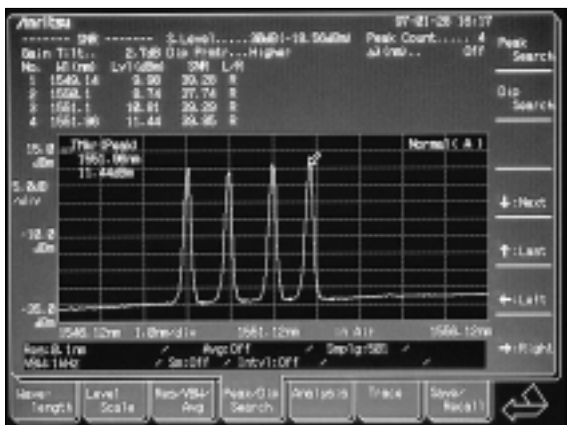

• Polarization mode dispersion

An important factor determining the upper limit of the transmission bit rate is the polarization mode dispersion (PMD). PMD is measured in the time and wavelength domains (see below). The MS9710B can be used as a fixed analyzer to perform simple and automated measurement in the wavelength domain and immediately computes the PMD by data processing from the measured waveform. The wavelength difference ($\lambda_2 - \lambda_1$) between the peak wavelength (λ_1) and the wavelength at the Nth peak (λ_2) are read directly, and the PMD is calculated from the following equation:

$$PMD = K \frac{N-1}{C} \times \frac{\lambda_1 \cdot \lambda_2}{\Delta \lambda}$$

where: K is the mode coupling factor and C is the speed of light (m/s).

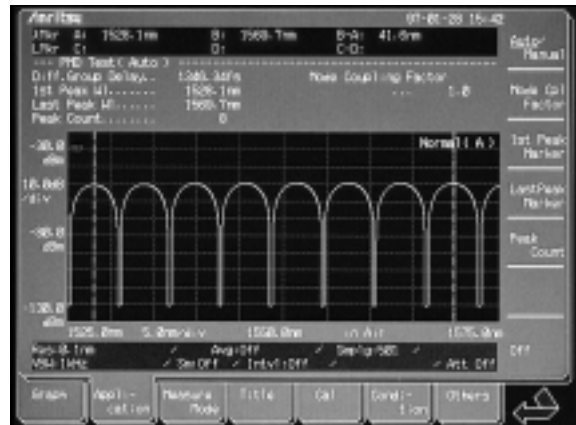

• NF measurement of fiber amplifier (EDFA)

NF measurement by the optical method using an optical spectrum analyzer measures the light input and output to and from the EDFA. NF is determined by the beat noise between the optical signal and the amplified spontaneous emission (ASE) as well as by the beat noise between the ASE (see below).

Since the MS9710B measures the ASE level with very high accuracy, three methods can be used to measure NF: 1. Pulse measurement (JIS Method: under discussing), 2. Level calibration using fitting, and 3. Polarized light nulling*. Moreover, measurement can be performed with the required dynamic range, level linearity, and polarization dependency.

*: This analyzer, available as the ME7890B Optical Amplifier Test System (uses a pulse method) in combination with the MF9619C Optical Modulator and a personal computer, is the best system for measuring WDM signals with the smallest possible error.

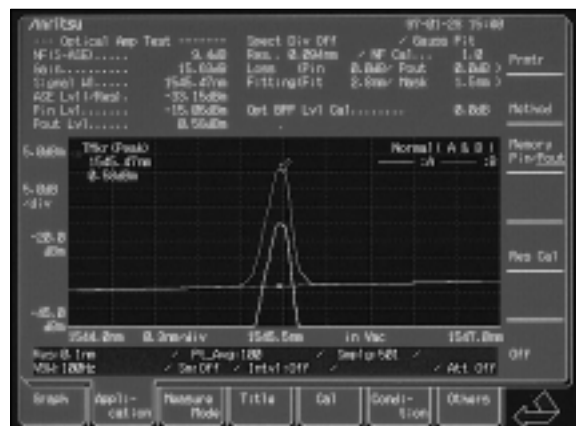

• **Convenient light source option (reference wavelength or white light) for better accuracy**

The SLD light source and reference wavelength light source (Option 13), SLD light source (Option 14), reference wavelength light source (Option 05), and white light source (Option 02) can each be installed in the MS9710B. The block diagram of the SLD light source and reference wavelength light source option is shown below. This option has two separate output ports: Port 1 for wavelength calibration and Port 2 for measuring transmission characteristics. When the MS9710B is calibrated automatically by inputting the reference light for the wavelength, post-calibration wavelength accuracy in the 1.52 to 1.57 μm range is better than ± 0.05 nm. This is very useful in precision absolute measurement of the wavelengths of light sources used in WDM systems.

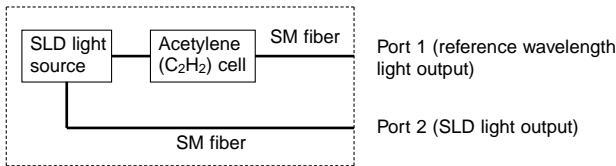

Block diagram of SLD light source & reference wavelength light

The following diagram shows the spectrum of the SLD light output from Port 2. When this light source is used instead of the earlier white light source for measurement of the wavelength transmission characteristics of optical receiver elements, it is possible to achieve a 20 dB wider dynamic range.

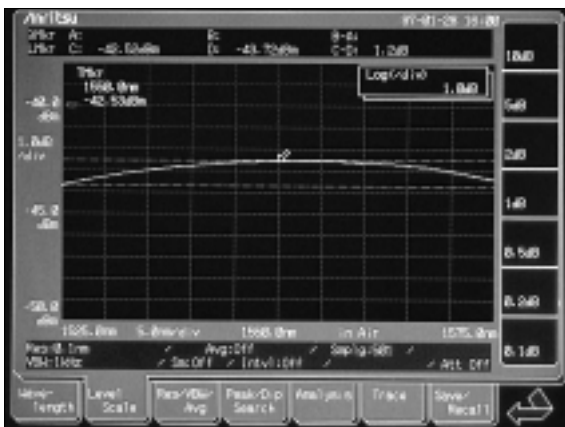

Spectrum of SLD light source

• **Measurement of modulated and pulsed light**

The synchronization signal for the measured modulated/pulsed light is input to the external input trigger on the rear panel. With this analyzer, the data can be held by this sync signal. As a result, the spectrum of the modulated or pulsed light can be measured accurately without data loss. In addition, an optical source that does not have a sync signal can be measured in the same manner by setting an appropriate gate time. The waveform in the diagram on the right shows measurement of an optical pulse (OTDR's light source) with a pulse width of 1 μs and a duty cycle of 1%. However, for accurate spectrum measurement, the VBW must be set to a wider bandwidth than the modulation frequency of the measured light (see below). The maximum settable VBW in the MS9710B is 1 MHz. (Refer to the specifications page for the relationship between VBW, received light sensitivity and sweep time.)

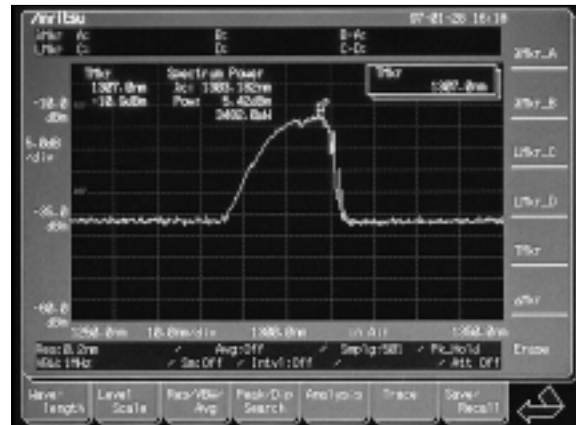

• **Tracking with tunable laser source**

By connecting the TLS of MG9541A and the MS9710B with an RS-232C cable, tracking operation is achieved. This setup provides an optical scalar network analyzer without an external controller. This setup is very convenient for measuring the wavelength transmission characteristics of wide dynamic range optical elements.

Measurement is performed using the MS9710B soft keys; the analyzer's marker, trace, and smoothing functions permit easy analysis of measurement results, including transmission loss, full width half maximum (FWHM) stop-band loss characteristics.

The screen below shows a measurement example for a dielectric filter with a center wavelength of 1540 nm. The screen shows a pass band and stop band loss characteristics. Measurement is possible at a wide dynamic range of better than 70 dB when the MS9710B resolution bandwidth is set 0.2 nm.

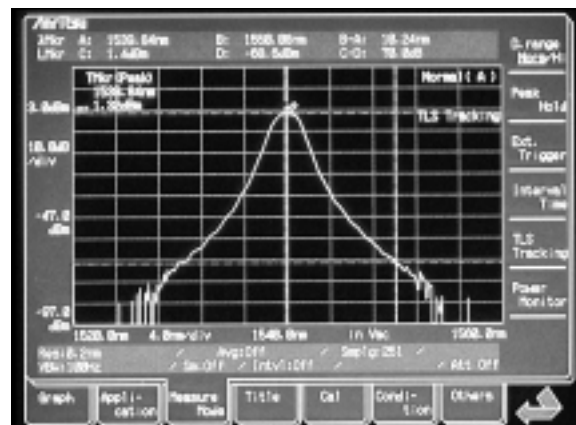

Specifications

• MS9710B

Fiber	10/125 μm SM fiber (ITU-T G.652)
Optical connector*1	User replaceable: FC, SC, ST, DIN, HMS-10/A Factory option (not user replaceable): E-2000 (Diamond), EC (Radial), FC-APC, SC-APC, HRL-10
Wavelength	Range: 600 to 1750 nm Accuracy: ±0.2 nm (1530 to 1570 nm, after wavelength calibration) ±0.3 nm (600 to 1750 nm, after wavelength calibration) ±0.05 nm (1530 to 1570 nm, resolution: 0.07 to 0.2 nm, after calibration with wavelength reference light source option) ±0.1 nm (1530 to 1570 nm, resolution: 0.5 to 1 nm, after calibration with wavelength reference light source option) Stability: ±5 pm (smoothing: 11 points, 1 minute, at half-width center wavelength) Linearity: ±20 pm (1530 to 1570 nm) Resolution: 0.07, 0.1, 0.2, 0.5, 1 nm Resolution accuracy*2: ±2.2% (resolution: 0.5 nm, 1550 ±20 nm), ±5% (resolution: 0.5 nm, at other wavelength), ±3% (resolution: 0.2 nm, 1550 ±20 nm), ±15% (resolution: 0.2 nm, at other wavelength), ±7% (resolution: 0.1 nm, 1550 ±20 nm), ±30% (resolution: 0.1 nm, at other wavelength)
Level	Measurement range: -65 to +10 dBm (600 to 1000 nm, +10° to +30°C, VBW: 10 Hz, sweep averaging: 10 times) -85 to +10 dBm (1000 to 1250 nm, +10° to +30°C, VBW: 10 Hz, sweep averaging: 10 times) -90 to +10 dBm (1250 to 1600 nm, +10° to +30°C, VBW: 10 Hz, sweep averaging: 10 times) -75 to +10 dBm (1600 to 1700 nm, +10° to +30°C, VBW: 10 Hz, sweep averaging: 10 times) -55 to +10 dBm (1700 to 1750 nm, +10° to +30°C, VBW: 10 Hz, sweep averaging: 10 times) -65 to +20 dBm (1100 to 1600 nm, attenuator: on) Accuracy: ±0.4 dB (1300/1550 nm, -23 dBm, resolution: ≥0.1 nm) Stability: ±0.02 dB (1550 nm, -23 dBm, resolution: ≥0.1 nm, 1 minute, constant temperature, no polarization shift) Linearity: ±0.05 dB (1550 nm, 0 to -50 dBm) Flatness: ±0.1 dB (1530 to 1570 nm)
Polarization dependency	±0.05 dB (1.55 μm band, resolution: ≥0.5 nm), ±0.1 dB (1.3 μm band, resolution: ≥0.5 nm)
Dynamic range	70 dB (±1 nm, resolution: 0.07 nm, 1.55 μm band, high-dynamic range mode measurement, 20° to 30°C) 60 dB (±0.5 nm, resolution: 0.07 nm, 1.55 μm band, high-dynamic range mode measurement, 20° to 30°C) 62 dB (±1 nm, resolution: 0.07 nm, 1.55 μm band, normal mode measurement) 58 dB (±0.5 nm, resolution: 0.07 nm, 1.55 μm band, normal mode measurement)
Optical return loss	≥35 dB (1.3/1.55 μm band)
Sweep	Sweep width: 0, 0.2 to 1200 nm Sweep speed*3(typical): 0.5 s (sweep width: 500 nm, normal mode measurement, VBW: 10 kHz)
Display	6.4 inch color TFT-LCD
Memory	A, B (2 traces), 3.5 inch FDD (for Windows®)
Printer	Internal (thermal type)
Interface	GPIO, RS-232C
Main functions	Optical pulse measurement, power monitor, wavelength auto-calibration
Operating conditions	Operating temperature: 0° to +50°C (FDD: 5° to 50°C), storage temperature: -20° to +60°C, Relative humidity: ≤90% (no condensation)
Power	85 to 132 Vac/170 to 250 Vac, 47.5 to 63 Hz, 150 VA (max.)
Dimensions and mass	320 (W) x 177 (H) x 350 (D) mm, ≤16.5 kg
EMC	EN61326: 1997/A1: 1998 (Class A), EN61000-3-2: 1995/A2: 1998 (Class A), EN61326: 1997/A1: 1998 (Annex A)
LVD	EN610101-1: 1993/A2, 1995 (Installation Category II, Pollution degree 2)

*1: One of these connector is attached. Please specify when ordering.

*2: Actual screen resolution

*3: Typical value for reference; not guaranteed specification

• White light source (Option 02)

Optical output	≥-59 dBm/1 nm (multimode/fiber input)*1
Wavelength range	900 to 1600 nm
Operating temperature	18° to 28°C

*1: -65 dBm (typ.) measured with MS9710B (at 1 nm wavelength resolution) which has single mode fiber at the input

• Reference wavelength light source (Option 05)

Wavelength reference	1.53 μm band Acetylene
----------------------	------------------------

• Wavelength Reference & SLD light source (Option 13)

Wavelength range	1450 to 1650 nm
Output level	>-40 dBm/nm (1550 nm ±10 nm) >-60 dBm/nm (1450 to 1650 nm)
Output level stability*1	±0.04 dB (MS9710B setting resolution: 1 nm, no polarization change, constant temperature, measured for 20 min at 1550 nm)
Spectrum half width	>70 nm (typical: 90 nm)
Optical connector	User replaceable type (FC, SC, ST, DIN, HMS-10/A)
Operating temperature	0° to 40°C
Wavelength reference	1530 nm band Acetylene

*1: Measured after one hour warm-up

• SLD light source (Option 14)

Wavelength range	1450 to 1650 nm
Output level	>-40 dBm/nm (1550 nm ±10 nm) >-60 dBm/nm (1450 to 1650 nm)
Output level stability*1	±0.04 dB (MS9710B setting resolution: 1 nm, no polarization change, constant temperature, measured for 20 min at 1550 nm)
Spectrum half width	>70 nm (typical: 90 nm)
Optical connector	User replaceable type (FC, SC, ST, DIN, HMS-10/A)
Operating temperature	0° to 40°C

*1: Measured after one hour warm-up

• **VBW, sweep speed, minimum light reception sensitivity*1**

VBW	10 Hz	100 Hz	1 kHz	10 kHz	100 kHz	1 MHz
Sweep speed (typ.)	30 s	5 s	0.5 s	0.5 s	0.5 s	0.5 s
Minimum light reception sensitivity*2	-90 dBm	-80 dBm	-70 dBm	-60 dBm	-50 dBm	-40 dBm

*1: Data for reference; not guaranteed specifications (except tracking with MG9541A)

*2: RMS noise level (1.25 to 1.6 μm)

Note: Warm-up to the MS9710B for about 5 minutes to ensure stable operation. The above specifications were obtained 2 hours after power-on.

Ordering information

Please specify model/order number, name, and quantity when ordering.

Model/Order No.	Name
MS9710B	Main frame Optical Spectrum Analyzer
	Standard accessories
	Optical connector adapter*1: 1 pc
	Power cord, 2.5 m: 1 pc
F0012	Fuse, 3.15 A (for 100/200 Vac system): 2 pcs
Z0312	Printer paper: 2 rolls
W1283AE	MS9710B operation manual: 1 copy
W1284AE	Remote control operation manual: 1 copy
MX971002S	LabVIEW® driver (RS-232C): 1
MX971002G	LabVIEW® driver (GPIB): 1
B0329G	Front cover: 1 pc
	Options
MS9710B-02	White light source*2
MS9710B-05	Reference wavelength light source*2
MS9710B-06	Monitor output
MS9710B-13	Wavelength reference & SLD light source*2
MS9710B-14	SLD light source*2
MS9710B-25	FC-APC connector*3
MS9710B-26	SC-APC connector*3
MS9710B-27	E2000 (Diamond) connector*3
MS9710B-31	EC (Radial) connector*3
MS9710B-37	FC connector*4
MS9710B-38	ST connector*4
MS9710B-39	DIN connector*4
MS9710B-40	SC connector*4
MS9710B-43	HMS-10/A (Diamond) connector*4
MS9710B-47	HRL-10 connector*3
	Application parts
J0654A	RS-232C cable, 9P-9P
J0655A	RS-232C cable, 9P-25P
J0007	GPIB cable, 1 m
J0617B	Replaceable optical connector (FC)
J0618D	Replaceable optical connector (ST)
J0618E	Replaceable optical connector (DIN)
J0618F	Replaceable optical connector (HMS-10/A)
J0619B	Replaceable optical connector (SC)
J0635B	FC-PC-FC-PC-2M-SM (FC-PC optical fiber cord, 2 m, SM)
Z0282	Ferrule cleaner
Z0283	Replacement reel for ferrule cleaner (for Z0282)
Z0284	Cleaner for optical adapter (stick type)
B0336C	Hard carrying case
G0084A	Polarization rotation module (for PMD measurement)
B0330C	Tilt stand

*1: Specify the connector to be supplied as the standard connector when ordering the above options. If the connector is not specified, the FC connector (MS9710B-37) is supplied as standard.

*2: Factory options; Two units cannot be installed simultaneously. Exchangeable-type optical connectors (FC, SC, ST, DIN, HMS-10/A) are supplied when specified at ordering. One conversion cord is supplied for connecting other optical connectors to the FC connector.

*3: Factory option

*4: User replaceable

Windows® is a registered trademark of Microsoft Corporation.

LabVIEW® is a registered trademark of National Instruments.

WDM NETWORK TESTER
MS9720A

For Manufacturing Devices for WDM Optical Communications and for Installing and Maintaining Networks

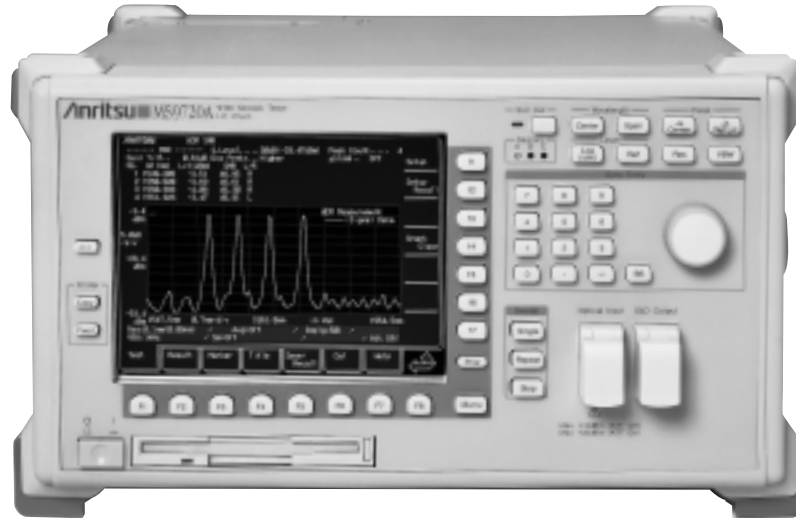

The MS9720A is an optical spectrum analyzer with a diffraction grating that is used to measure and analyze optical spectra in the 1450 to 1650 nm band for WDM communications systems. In addition to having excellent basic performance, such as high wavelength accuracy, wide dynamic range, and good optical reception sensitivity ideally suited to measurement and analysis of the optical spectra used in WDM communications, it has a full line-up of functions matching a wide range of needs ranging from manufacturing of WDM communications devices to installation and maintenance.

Features

- ± 20 pm wavelength accuracy (reference optical source built-in)
- 58 dB dynamic range (1 nm from signal wavelength)
- -87 dBm optical reception sensitivity
- Three memories, three traces, split screen
- Full line-up of functions and applications
- VGA output connector

Performance and functions

• ± 20 pm wavelength accuracy with built-in light source

A wavelength accuracy of ± 20 pm is achieved over a range of 1530 to 1570 nm by performing calibration using the built-in wavelength reference light source. Wavelength calibration is performed automatically just by pressing the Cal key, permitting accurate measurement of the absolute wavelength value required in evaluation of WDM systems. Calibration of the absolute wavelength value uses the absorption spectrum of acetylene. The block diagram of the calibration light source is shown below. In addition, the output of the built-in SLD light source can be used for evaluating the transmission characteristics of passive elements.

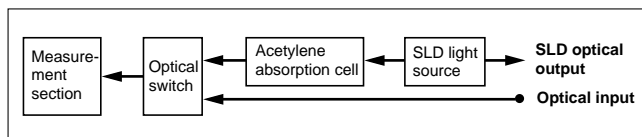

Block diagram of calibration light source

• 58 dB dynamic range

The measurement dynamic range at the wavelength 1 nm from the peak is 58 dB demonstrating the tester's power when measuring the SNR of light sources in WDM systems and when evaluating filters, etc. The following screens show the dynamic range at 1 and 0.5 nm from the peak.

Dynamic range	58 dB (1 nm from peak)
	53 dB (0.5 nm from peak)

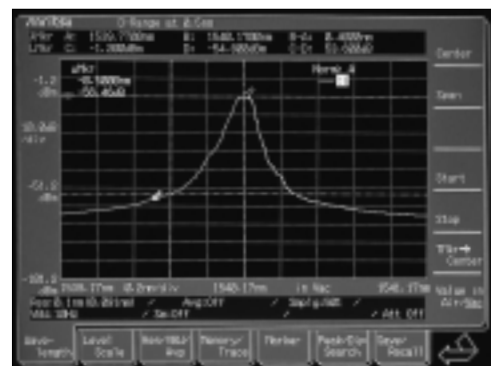
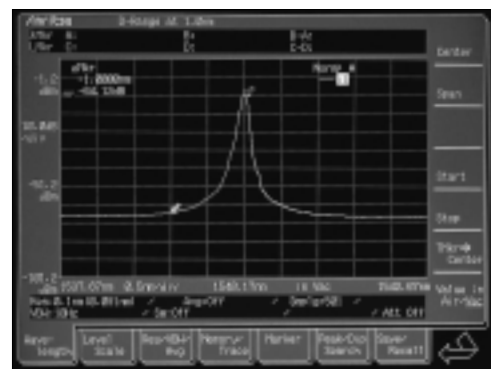

• **Full line-up of functions and applications**

In addition to its excellent basic performance, the MS9720A has a full line-up of useful functions. The basic waveform analysis functions offer applications for evaluating every important item in WDM systems.

Waveform analysis	Threshold analysis, SMSR analysis, spectrum power (integrated power calculation)
Applicable measurement	Insertion loss, isolation, directivity, return loss, polarization mode dispersion (PMD), fiber amplifier noise figure (NF), WDM wavelength analysis, long-term measurement

The following screens show threshold and SNR analysis of a WDM signal waveform. The effective analysis range is set using the Zone Marker even for WDM signals, enabling independent analysis of the waveform of each channel.

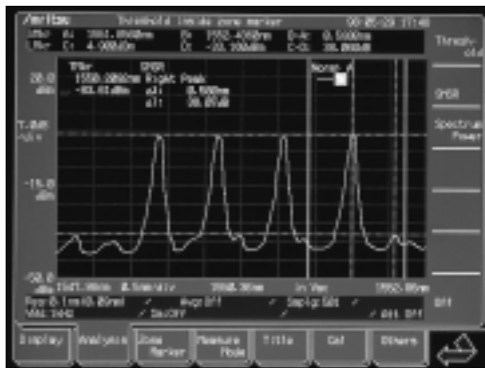
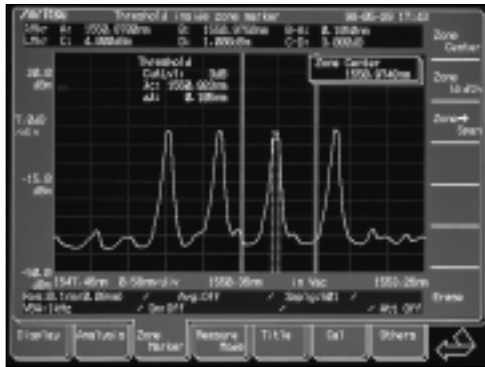

• **Long-term measurement**

The MS9720A has a long-term measurement function for displaying the wavelength, level, and SNR, etc., as a table, and saving the average, maximum, and minimum value of each measurement to floppy disk as a text file at a set measurement interval. The wavelength is calibrated every 6 hours and the level is calibrated every 1 hour in long-term measurement.



Specifications

Applicable fiber	10/125 μm SM fiber (ITU-T G.652)
Optical connector	User replaceable (FC, SC, ST, DIN, HMS-10/A), Factory option (E2000, FC-APC, SC-APC, HRL-10)
Wavelength	Range: 1450 to 1650 nm Accuracy: ±20 pm (1550 ±20 nm, room temperature), ±50 pm (1520 to 1600 nm), ±0.3 nm (all range) *After wavelength calibration Stability: ±5 pm (smoothing: 11 pt, 1 minute, at half-width of center wavelength) Linearity: ±20 pm (1550 ±20 nm) Read resolution: 5 pm (display resolution: 1 pm) Setting resolution: 0.1, 0.2, 0.5, 1.0 nm (filter: 3 dB bandwidth) Resolution accuracy: ≤±10% (1550 ±20 nm, 0° to 30°C), ≤±30% (1550 ±100 nm, 0° to 30°C)
Level	Measurement level ranges: -87 to +10 dBm (1450 to 1600 nm, 0° to 30°C), -72 to +10 dBm (1600 to 1650 nm, 0° to 30°C), -82 to +10 dBm (1450 to 1600 nm, 30° to 50°C), -67 to +10 dBm (1600 to 1650 nm, 30° to 50°C), -68 to +23 dBm (1450 to 1600 nm, 0° to 30°C, internal optical attenuator: on) Accuracy: ±0.4 dB (1550 nm, -23 dBm) Stability: ±0.02 dB (1550 nm, -23 dBm, 1 minute, constant temperature, no polarization fluctuation) Linearity: ±0.05 dB (1550 nm, -50 to 0 dBm) Flatness: ±0.1 dB (1550 ±20 nm), ±0.3 dB (1520 to 1600 nm)
Polarization dependency	±0.15 dB
Dynamic range	58 dB (at point 1 nm from peak), 53 dB (at point 0.5 nm from peak)
Optical return loss	35 dB (1550 nm)
SLD output	>-40 dBm/nm (at 1550 nm)
Display	6.4 inch color TFT-LCD
Memory trace	Three measurement memories and three trace displays

Continued on the next page

Printer	Internal (thermal type)
Interface	GPIO, RS-232C, monitor output (VGA compatible)
Data save/output	3.5 inch floppy disk drive
EMC	EN61326: 1997/A1, 1998 (Class A) EN61000-3-2: 1995/A2, 1998 (Class A) EN61326: 1997/A1, 1998 (Annex A)
LVD	EN610101-1: 1993/A2, 1995 (Installation Category II, Pollution degree 2)
Ambient conditions	Operating temperature: 0° to +50°C (however, 5° to 50°C for FDD) Storage temperature: -20° to +60°C Relative humidity: ≤90% (no condensation, 20% to 80% for FDD)
Power	85 to 132/172 to 250 Vac, 47.5 to 63 Hz, 150 VA (max.)
Dimensions and mass	320 (W) x 177 (H) x 350 (D) mm (excluding projections), ≤16.5 kg

Note: Warm-up to the MS9720A for about 5 minutes to ensure stable operation. The above specifications are obtained at 2 hours after power-on.

Ordering information

Please specify model/order number, name, and quantity when ordering.

Model/order No.	Name
MS9720A	Main frame WDM Network Tester
	Standard accessories
	Optical connector adapter*1: 1 pc
F0012	Fuse, 3.15 A (for 100/200 Vac): 2 pcs
W1343AE	MS9720A operation manual: 1 copy
W1344AE	MS9720A remote control operation manual: 1 copy
	Power cord, 2.6 m: 1 pc
B0329G	Front cover (3/4MW4U): 1 pc
Z0312	Printer paper: 2 rolls
MX972001S	LabVIEW® Driver (RS-232C): 1 pc
MX972001G	LabVIEW® Driver (GPIO): 1 pc
	Options
MS9720A-27	E2000 (DIAMOND) connector
MS9720A-37	FC connector
MS9720A-38	ST connector
MS9720A-39	DIN connector
MS9720A-40	SC connector
MS9720A-43	HMS-10/A (DIAMOND) connector
MS9720A-47	HRL-10 connector (factory option)
	Application parts
MN9604C	Optical Directional Coupler
J0654A	Serial interface cable (IBM-PC/AT, J-310, remote control)
J0655A	Serial interface cable (9P-25P)
J0007	GPIO cable, 1 m
J0617A	Replaceable connector (FC)
J0618D	Replaceable connector (ST)
J0618E	Replaceable connector (DIN)
J0618F	Replaceable connector (HMS-10/A)
J0619B	Replaceable connector (SC)
J0635B	Optical fiber cord (FC · PC-FC · FC-2M-SM), 2 m
J0441	Total internal reflection fiber cord
Z0282	Replacement reel for ferrule cleaner (Kuretop A type)
Z0283	Ferrule cleaner spare tape (for Z0282, 6 pcs/set)
Z0284	Adapter cleaner (stick type, 200 pcs/set)
B0330C	Tilt bail
B0336C	Hard carrying case
G0084A	Polarization rotation module

*1: Specify the connector to be supplied as the standard connector when ordering the above options.
If the connector is not specified, the FC connector (MS9720A-37) is supplied as standard.

OPTICAL SPECTRUM ANALYZER
MS9780A
 600 to 1750 nm

For Fibers with Core Diameters of 10, 50, and 62.5 μm



The MS9780A is a diffraction-grating spectrum analyzer for analyzing optical spectra in the 600 to 1750 nm wavelength band. Its input section has been redesigned to support fibers with core diameters of 50/62.5 μm; the input section of the MS9780A can be used to measure the spectra of LDs and LEDs, etc. In addition to uses such as measurement of LD and LED spectra, it has functions for measuring the transmission characteristics of passive elements such as optical isolators, as well as the NF/Gain of optical fiber amplifier systems. In addition to its basic features, the superior stability and reliability of the diffraction-grating (patent pending) capability easily passes the severe specifications required for the precise measurement of WDM communications methods, particularly in the 1.55 μm band. This analyzer, which is backed by Anritsu's high-level technology, has the dynamic range, reception sensitivity and sweep speed requested by users. Its high sensitivity meets the exacting demands placed on today's measuring instruments. In particular, the excellent wavelength and level specifications fully meet the dense WDM requirements in the 1.55 μm band. In addition to the high reliability and excellent basic performance, this analyzer has a full range of application functions to support accurate measurement in the fastest possible time.

Features

- 70 dB dynamic range
- -90 dBm guaranteed optical reception sensitivity
- Optical pulse measurement
- Full range of WDM application functions
- Tracking with tunable laser source

Applications

• 70 dB dynamic range
 The measurement dynamic range of the MS9780A in the normal measurement mode at a wavelength 1 nm from the peak wavelength is 62 dB. In the high-dynamic range measurement mode, better than 70 dB can be achieved. The analyzer demonstrates its excellence in SMSR measurement of DFB-LDs, as well as in evaluation of narrow-band optical band pass filters.

Measurement mode	Dynamic range (at SM fiber)	
	1 nm from peak	0.5 nm from peak
High dynamic range	70 dB	60 dB
Normal	62 dB	58 dB

Wide-dynamic range measurement example with DFB-LD spectrum passed via narrow-band BPF.

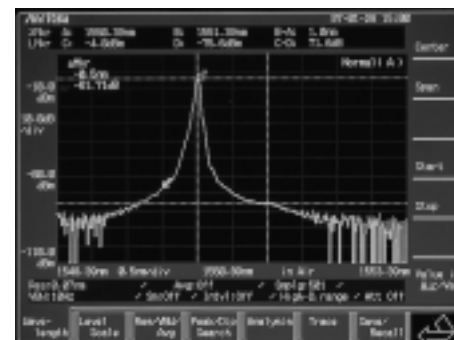
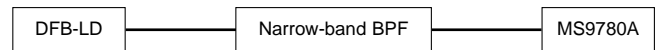

• -90 dBm guaranteed optical reception sensitivity

The MS9780A has achieved an improved S/N over a wide range by taking thorough countermeasures to noise and stray light. The RMS noise level at wavelengths from 1250 to 1600 nm is -90 dBm max. In addition, the S/N can be improved using sweep averaging. The screen display below shows the waveform after 10 averagings; the S/N is improved by more than 5 dB.

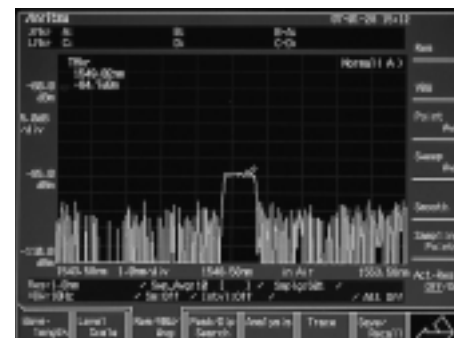

• Full function lineup

In addition to its excellent basic functions, the MS9780A comes with a full lineup of other useful functions summarized in the following table.

Device analysis	For analyzing and evaluating waveforms of optical elements (DFB-LDs, FP-LDs, LEDs)
Waveform analysis	For waveform analysis by RMS and threshold methods; SMSR, half-width evaluation, WDM waveform analysis
Application measurement	EDFA NF and gain measurement, PMD measurement (See applications.)
Modulation, pulsed light measurement	Max. frequency range (VBW) = 1 MHz (See applications.)
Markers	Multimarkers: Marker function for max. 128 points (See applications.) Zone markers: For waveform analysis in zone specified zone Peak/dip search: Searches for a peak or dip
Power monitor	Also functions as optical power meter
Vacuum wavelength	Converts displayed wavelength to value in display vacuum
External interfaces	GPIB, RS-232C

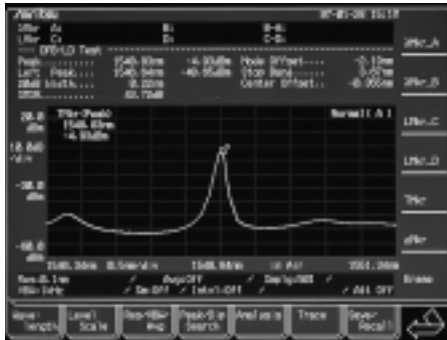

• Spectrum analysis for WDM communication systems

Difficult problems in WDM transmission technology are the wavelength characteristics for the gain, and signal to noise ratio (SNR) between each channel. In evaluation, it is very important to measure this quantitatively. The MS9780A permits extremely quick and simple waveform analysis of up to 128 spectra. The waveform and level (SNR) of each peak exceeding the set threshold is displayed. The screen display below shows an example of the tilt gain.

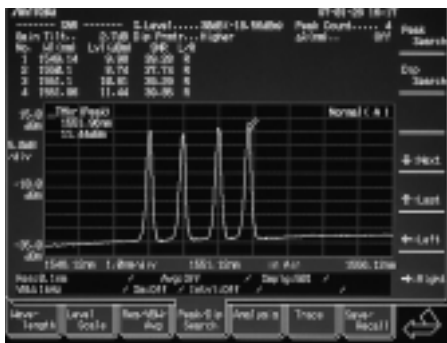

• Convenient light source option (refer wavelength light) for better accuracy

Any one of the wavelength reference & SLD light source (Option 03), SLD light source (Option 04), reference wavelength light source (Option 05), and white light source (Option 02) can be installed in the MS9780A.

The block diagram of the wavelength reference & SLD light source option is shown below. This option has two separate output ports: Port 1 for wavelength calibration, and Port 2 for measuring transmission characteristics. When the MS9780A is calibrated automatically by inputting the reference light for the wavelength, post-calibration wavelength accuracy in the 1.52 to 1.57 μm range is better than ± 0.05 nm. This is very useful in precision absolute measurement of the wavelengths of light sources used in WDM systems.

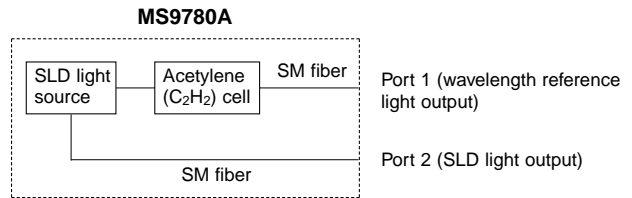

Block diagram of wavelength reference & SLD light

The following diagram shows the spectrum of the SLD light output from Port 2. When this light source is used instead of the earlier white light source for measurement of the wavelength transmission characteristics of optical receiver elements, it is possible to achieve a 20 dB wider dynamic range.

The following figure shows an example of measuring the transmission characteristics of optical band pass filter using the SLD light.

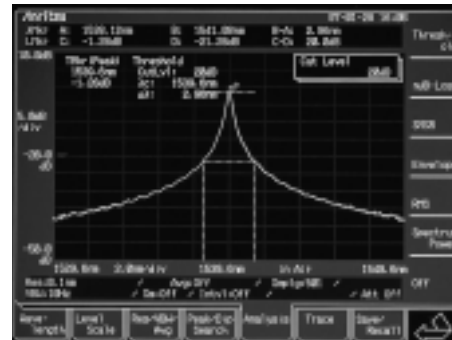

Measurement of optical band pass filter

If this dynamic range is not required, a lower-cost white light source can be installed instead. The following figure shows the spectrum of the white light source. When this light is used, transmission characteristics can be measured in wide range of 900 to 1750 nm.

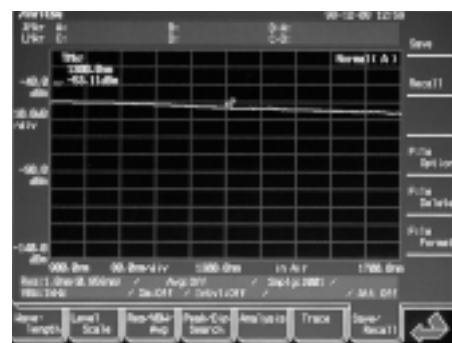

Spectrum of white light source

Specifications

• MS9780A

Fiber	SM (9.5/125 μm), GI (50/125 μm)*1, GI (62.5/125 μm)*1
Wavelength	Range : 600 to 1750 nm Sweep width: 0, 0.2 to 1200 nm Accuracy: ±0.3 nm (600 to 1750 nm, after wavelength calibration with external light source) ±0.05 nm (1550 ±20 nm, resolution: 0.07 to 0.2 nm, after calibration with wavelength reference light source option)*2 ±0.1 nm (1550 ±20 nm, resolution: 0.5/1.0 nm, after calibration with wavelength reference light source option)*2 Stability: ±5 pm (1 minute)
Resolution	Setting: 0.07*2, 0.1, 0.2, 0.5, 1.0 nm Accuracy*2,*3: ±30% (1300/1550 nm, resolution: 0.1 nm), ±15% (1300/1550 nm, resolution: 0.2 nm), ±7% (1300/1550 nm, resolution: 0.5 nm)
Level	Measurement range (attenuator: off, 0° to +30°C): -65 to +10 dBm (600 to 1000 nm), -85 to +10 dBm (1000 to 1250 nm), -90 to +10 dBm (1250 to 1600 nm), -75 to +10 dBm (1600 to 1700 nm), -55 to +10 dBm (1700 to 1750 nm, +10° to +30°C) Measurement range (attenuator: on, 0° to +30°C): -65 to +20 dBm (1100 to 1650 nm) Accuracy*2: ±0.6 dB (1300/1500 nm, -23 dBm, resolution: ≥0.2 nm) Stability*2: ±0.1 dB (1550 nm, -23 dBm, resolution: ≥0.2 nm, 1 minute) Linearity*2: ±0.1 dB (1550 nm, -50 to 0 dBm) Polarization dependency*2: ±0.15 dB (1300/1500 nm, resolution: ≥0.5 nm) Dynamic range*2 Normal mode: 62 dB (±1 nm), 58 dB (±0.5 nm) *1550 nm, resolution: 0.07 nm Wide dynamic range mode: 70 dB (±1 nm), 60 dB (±0.5 nm) *1550 nm, resolution: 0.07 nm, 25° ±5°C Return loss*2: 32 dB (1300/1550 nm)
Sweep	Sweep width: 0, 0.2 to 1200 nm Sweep speed (typical*4): 0.5 s (sweep width: 500 nm, normal mode measurement, VBW: 10 kHz)
Display	6.4 inch color TFT-LCD
Memory	A, B (2 trace), 3.5 inch FDD (for Windows®)
Printer	Internal (thermal type)
Interface	GPIO, RS-232C
Main functions	Optical pulse measurement, power monitor, wavelength auto-calibration
Operating conditions	Operating temperature: 0° to +50°C (FDD: 5° to 50°C), Storage temperature: -20° to +60°C Relative humidity: ≤90% (no condensation)
Power	85 to 132 Vac/170 to 250 Vac, 47.5 to 63 Hz, 150 VA (max.)
Dimensions and mass	320 (W) x 177 (H) x 350 (D) mm, ≤16.5 kg
EMC	EN61326: 1997/A1, 1998 (Class A) EN61000-3-2: 1995/A2, 1998 (Class A) EN61326: 1997/A1, 1998 (Annex A)
LVD	EN610101-1: 1993/A2, 1995 (Installation Category II, Pollution degree 2)

*1: The NA of GI fiber is 0.2 for a core diameter of 50/125 μm and 0.275 for 62.5/125 μm. However, the permissible NA is 0.1 due to the spectroscopy limitations.

*2: Connects to SM fiber (10/125 μm)

*3: Effective resolution value

*4: Typical value for reference; not guaranteed specification

• White light source (Option 02)

Optical output	≥-59 dBm/1 nm (typical value: -55 dBm/1 nm)
Wavelength range	900 to 1600 nm
Operating temperature	18° to 28°C

• Wavelength reference & SLD light source (Option 03)

Optical output	≥-40 dBm/1 nm (single mode/fiber input)
Wavelength range	1540 to 1560 nm
Operating temperature	15° to 30°C
Wavelength reference	1.53 μm band Acetylene

• SLD light source (Option 04)

Optical output	≥-40 dBm/nm (single mode/fiber input)
Wavelength range	1540 to 1560 nm
Operating temperature	15° to 30°C

• Reference wavelength light source (Option 05)

Wavelength reference	1.53 μm band Acetylene
----------------------	------------------------

• VBW, sweep speed, minimum light reception sensitivity*6

VBW	10 Hz	100 Hz	1 kHz	10 kHz	100 kHz	1 MHz
Sweep speed (typ.)	30 s	5 s	0.5 s	0.5 s	0.5 s	0.5 s
Minimum light reception sensitivity*7	-90 dBm	-80 dBm	-70 dBm	-60 dBm	-50 dBm	-40 dBm

*6: Data for reference; not guaranteed specifications (except tracking with MG9541A)

*7: RMS noise level (1.25 to 1.6 μm)

Note: Warm-up to the MS9780A for about 5 minutes to ensure stable operation. The above specifications were obtained 2 hours after power-on.

Ordering information

Please specify model/order number, name, and quantity when ordering.

Model/Order No.	Name
MS9780A	Main frame Optical Spectrum Analyzer
	Standard accessories
	Optical connector adapter*1: 1 pc
	Power cord, 2.5 m: 1 pc
F0012	Fuse, 3.15 A (for 100 Vac system): 2 pcs
Z0312	Printer paper: 2 rolls
W1477AE	MS9780A operation manual: 1 copy
W1478AE	Remote control operation manual: 1 copy
MX978001S	LabVIEW® driver (RS-232C): 1
MX978001G	LabVIEW® driver (GPIB): 1
B0239G	Front cover: 1 pc
	Options
MS9780A-02	White light source*2
MS9780A-03	Wavelength reference & SLD light source*2
MS9780A-04	SLD light source*2
MS9780A-05	Reference wavelength light source*2
MS9780A-06	Monitor output (VGA output)*3
MS9780A-27	E2000 (Diamond) connector*3
MS9780A-37	FC connector*4
MS9780A-38	ST connector*4
MS9780A-39	DIN connector*4
MS9780A-40	SC connector*4
MS9780A-43	HMS-10/A (Diamond) connector*4
	Application parts
J0654A	RS-232C cable (9P-9P)
J0655A	RS-232C cable (9P-25P)
J0007	GPIB cable, 1m
J0617B	Replaceable optical connector (FC)
J0618D	Replaceable optical connector (ST)
J0618E	Replaceable optical connector (DIN)
J0618F	Replaceable optical connector (HMS-10/A)
J0619B	Replaceable optical connector (SC)
J0635B	FC-PC · FC-PC · 2M-SM (FC-PC optical fiber cord, 2 m, SM)
J0893B	FC · PC-FC · PC-2M-GI (50/125 μm)
J0894B	FC · PC-FC · PC-2M-GI (62.5/125 μm)
J0203	Optical fiber cord with lens attached to end (50 μm core diameter), 2 m
J0204	Optical fiber cord with lens attached to end (200 μm core diameter), 2 m
Z0282	Ferrule cleaner (Cletop A type, 1 pc)
Z0283	Tape for ferrule cleaner (6 pcs/set)
Z0284	Cleaner for optical adapter (stick-type, 200 pcs/set)
B0336C	Hard carrying case
B0330C	Tilt stand

*1: Specify the connector to be supplied as the standard connector when ordering the above options. If the connector is not specified, the FC connector (MS9780A-37) is supplied as standard.

*2: Factory options; Two units cannot be installed simultaneously. Exchangeable-type optical connectors (FC, ST, DIN, HMS-10/A) are supplied when specified at ordering. One conversion cord is supplied for connecting other optical connectors to the FC connector.

*3: Factory option

*4: User replaceable

Note:

Windows® is a registered trademark of Microsoft Corporation.

LabVIEW® is a registered trademark of National Instruments.

WDM TESTER MS9715A 1.527 to 1.567 μm

For Maintaining and Monitoring WDM Optical Communication Systems

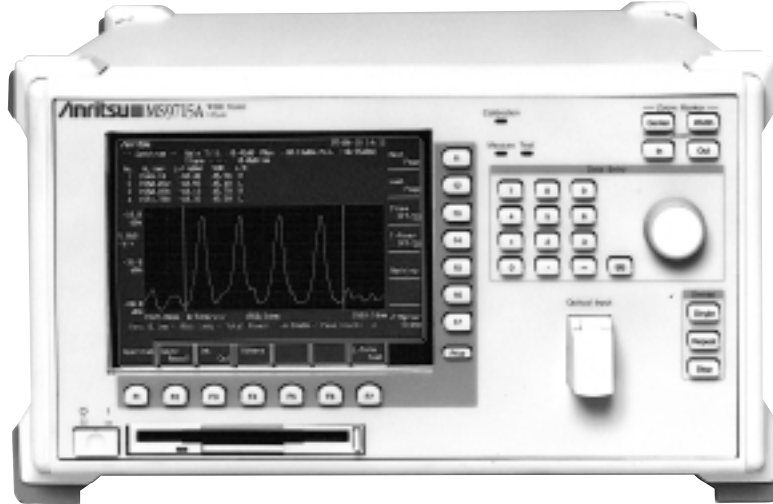

Custom-made product



Optical communications are getting into full swing. Great things are expected of WDM optical communications in answer to the recent social demand for dramatic increases in transmission volume. In WDM communications, multiple optical elements are used in an optical amplifier and various characteristics are precisely controlled to maintain system performance.

The MS9715A is a measuring instrument for use in system manufacture, construction, and maintenance. One instrument combines accurate measurement of necessary items over long periods and satisfies conditions of simplicity of use in construction and maintenance operations, lightness and compactness, and superior environmental performance with respect to vibration and shock. In addition, since the LabVIEW driver is fitted as standard, programming by remote control is simple. A windows compatible floppy disk drive is also fitted as standard.

Feature

- For WDM optical communication

Performance and functions

• Measurement items

Maximum, minimum, and average values over a long period for wavelength, level, SNR^{*1}, channel spacing^{*2}, gain tilt^{*3}, gain slope^{*4}, total power, and spectrum measurement.

*1: Signal to Noise Ratio (dB). Noise resolution level of 0.1 nm. Of the signal's 2 extremes, that with the greater level (smaller SNR) is automatically selected.

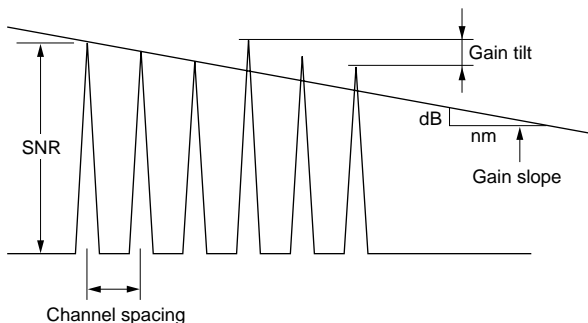

*2: Wavelength difference between spectra for individual signal (nm, GHz)

*3: Difference between maximum and minimum peak values for total signal spectrum

*4: Slope of least mean square regression line of total signal spectrum peaks (dB/nm)

• Superior basic functions

The MS9715A provides the high performance required for the performance testing and evaluation of WDM equipment. Wavelength measurement has ± 50 pm accuracy, ± 5 pm wavelength stability, and ± 20 pm wavelength linearity. High performance level measurement has a dynamic range of 53 dB (0.5 nm from peak), ± 0.4 dB level accuracy, ± 0.02 dB level stability, and ± 0.05 dB level linearity^{*5}.

*5: 5 performances at 0.1 nm resolution

• Calculation functions

Measurement calculation functions for SNR, gain tilt, total power, gain slope, channel spacing, etc. are provided.

• 2 measurement modes

Spectrum measurement mode and long-time measurement mode are provided. As shown on the screen below, in spectrum measurement mode, the results calculated are displayed. (Spectrum is expanded or contracted using the zoom marker).

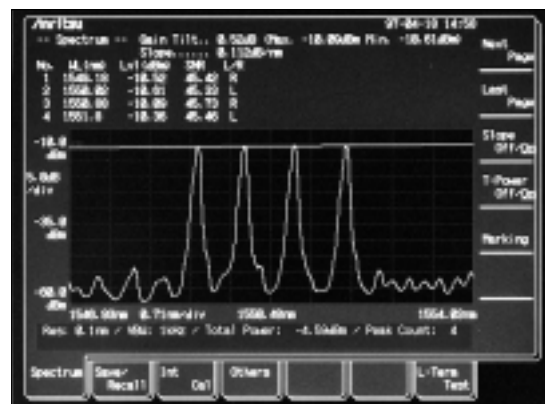

Example of gain tilt and gain slope display

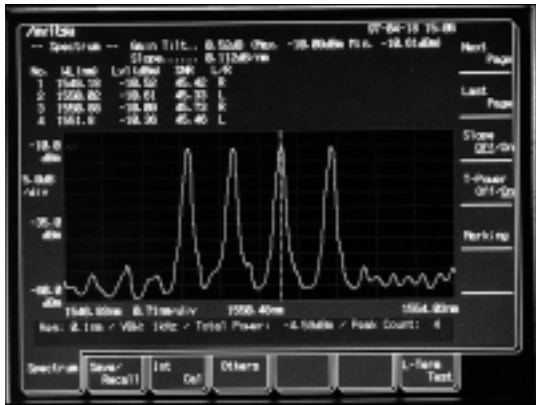

Example of specific spectrum emphasis display



Wavelength table

• Ease of operation

Measured wavelength settings can be freely expanded or contracted using the zoom marker. The guide spectrum for a specific spectrum can be found at a glance while freely setting the marker. In addition, the level axis is automatically set by detection of maximum and minimum. Wavelength calibration is performed automatically using an internal standard light source.

• Long-time mode

The long-time mode displays measurement results for wavelength, level, and SNR in tables. Besides average value, maximum value, minimum value, and maximum – minimum value for the time interval set by the user (sampling period), the table displays the difference between the current value and that at start time (initial long-time measurement). The wavelength tables also display channel spacing. The complete table value display for each sampling period is treated as one set, and a maximum of 1000 sets are recorded on floppy disk. The behavior of the measured system can be analyzed over a long time period. During the long-time measurement, wavelength calibration is performed automatically using the internal wavelength standard; even if ambient conditions change during the measurement, high wavelength measurement accuracy is secured.



Level table

Specifications

Wavelength	Range: 1.527 to 1.567 μm (integrate power: 1.52 to 1.58 μm) Accuracy: ± 0.05 nm Stability: ± 5 pm (1 min), ± 10 pm (constant temperature: 60 min) Linearity: ± 20 pm Resolution: 0.1 nm Resolution accuracy: $\pm 10\%$ (actual display resolution)
Level	Range: -65 to $+20$ dBm Accuracy: ± 0.4 dB Stability: ± 0.02 dB (-23 dBm, 1 min, constant temperature) Linearity: ± 0.05 dB (0 to -50 dBm) Flatness: ± 0.15 dB
Polarization dependency	± 0.25 dB
Dynamic range	58 dB (± 1 nm), 53 dB (± 0.5 nm)
Measurement signal	Max. 32 waves
Return loss	≥ 35 dB
Wavelength reference	Acetylene (1.52 μm)
Display	6.4", color TFT-LCD
Measurement item	Maximum, minimum and average values over a long period for wavelength, level, SNR, channel spacing, gain tilt, gain slope, total power, and spectrum
Memory	3.5" FD (for Windows)
Interface	RS-232C, GPIB
Environmental condition	Operating temperature: $+5^\circ$ to $+50^\circ\text{C}$ Storage temperature: -20° to $+60^\circ\text{C}$ Relative humidity: $\leq 90\%$
Power	AC 85 to 132/170 to 250 V, 47.5 to 63 Hz, ≤ 150 VA
Dimensions and mass	320 (W) x 177 (H) x 350 (D) mm, ≤ 16.5 kg
EMC	EN61326: 1997/A1, 1998 (Class A) EN61000-3-2: 1995/A2, 1998 (Class A) EN61326: 1997/A1, 1998 (Annex A)
LVD	EN610101-1: 1993/A2, 1995 (Installation Category II, Pollution degree 2)

Ordering information

Please specify model/order number, name, and quantity when ordering.

Model/order No.	Name
MS9715A	Mainframe WDM Tester (custom-made product)
	Standard accessories
	Power cord, 2.5 m: 1 pc
F0012	Fuse, 3.15 A (for 100/200 Vac system): 2 pcs
B0329G	Front cover (3/4MW4U): 1 pc
MX971501S	LabVIEW® driver (RS-232C): 1
MX971501G	LabVIEW® driver (GPIB): 1
W1234AE	MS9715A operation manual: 1 copy
W1235AE	MS9715A remote control operation manual: 1 copy
	Options
MS9715A-27	E-2000 (Diamond) connector
MS9715A-31	EC (Radial) connector
MS9715A-37	FC connector
MS9715A-38	ST connector
MS9715A-39	DIN connector
MS9715A-40	SC connector
MS9715A-43	HMS-10/A (Diamond) connector
	Optional accessories
J0654A	Serial interface cable (IBM-PC/AT, for J-310)
J0655A	Serial interface cable (9/25-pin)
J0007	GPIB cable, 1 m: 2 pcs
J0617B	Replaceable optical connector (FC)
J0618D	Replaceable optical connector (ST)
J0618E	Replaceable optical connector (DIN)
J0618F	Replaceable optical connector (HMS-10/A)
J0619B	Replaceable optical connector (SC)
J0635B	Optical fiber cord (FC-PC connector, for SM), 2 m
Z0282	Ferrule cleaner
Z0283	Tape for Ferrule cleaner (6 pcs/set, for Z0282)
Z0284	Adapter cleaner (200 pcs/set)

OPTICAL AMPLIFIER TEST SYSTEM ME7890B 1.530 to 1.620 μm

For Precise Evaluation of Amplifiers for WDM Optical Communications



*The photograph shows an example of the system composition.

GPIB

The optical amplifier is a key device in today's high-capacity and long-distance optical communications networks, and evaluation of the optical amplifier noise figure (NF) and gain demands measuring instruments with excellent performance and accuracy. The ME7890B covers both band of C-Band and L-Band. The ME7890B supports this need using the optical pulse probe method.

Feature

- High-accuracy NF and gain measurement using optical pulse probe method
- Fast, high-accuracy NF and gain measurement at low cost
- Supports optical pulse probe method

Performance and functions

• Optical pulse probe method

The ME7890B uses a combination of the optical pulse method to measure amplified spontaneous emission (ASE) of the optical amplifier with high accuracy, and the optical probe method to measure quickly over a wide wavelength range. The optical pulse probe method measures the wavelength characteristics using a weak optical signal (probe) that has almost no effect on the locked inversion of the optical amplifier. A saturating signal is input so that the optical amplifier is in exactly the same condition as when it is in actual use.

At evaluation of an optical amplifier for wavelength division multiplexing (WDM) communications, fewer saturating signals are substituted for the WDM light source, creating the same conditions as when a WDM optical signal is input. The probe signal light is used to measure the NF and gain, and then a wavelength tunable laser source or a wide-band light source is used for measurement over a wide wavelength range.

The following graph compares the gain measured by the pulse and probe methods using a 16-channel WDM light source. Almost the same gain wavelength characteristics are obtained by substituting a single-channel saturating signal with the same total power as the 16-channel WDM light source.

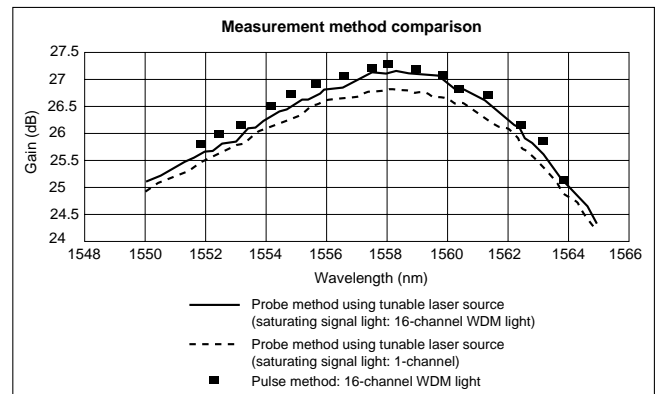

The measurement error when the number of optical saturating signals becomes smaller depends on the characteristics of the optical amplifier under test, as well as on the appropriately number of saturating signals, the wavelengths, power, and probe signal power: accurate comparison with the pulse method results requires determination of these parameters.

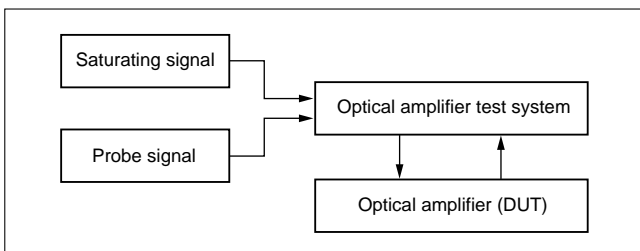

• Standard configuration

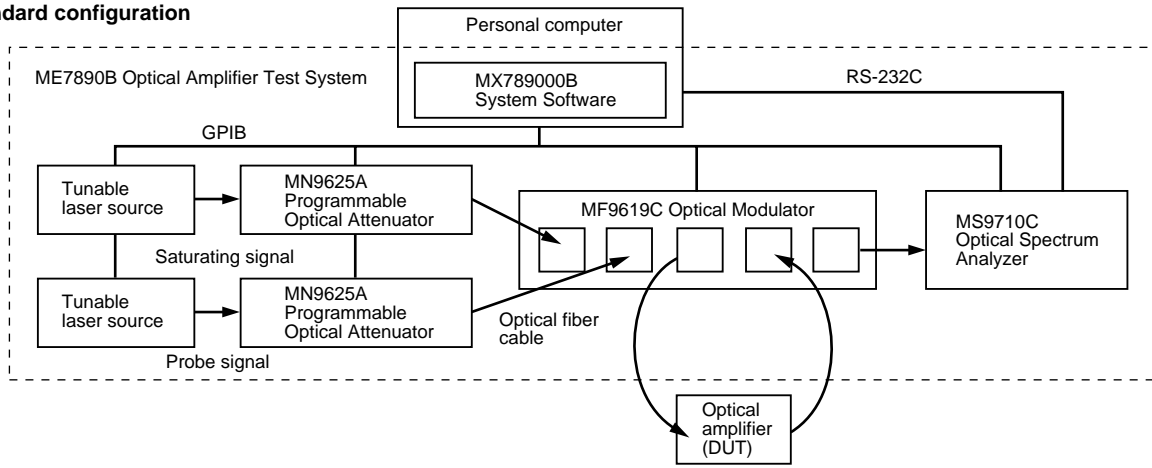

• Using WDM Light Source

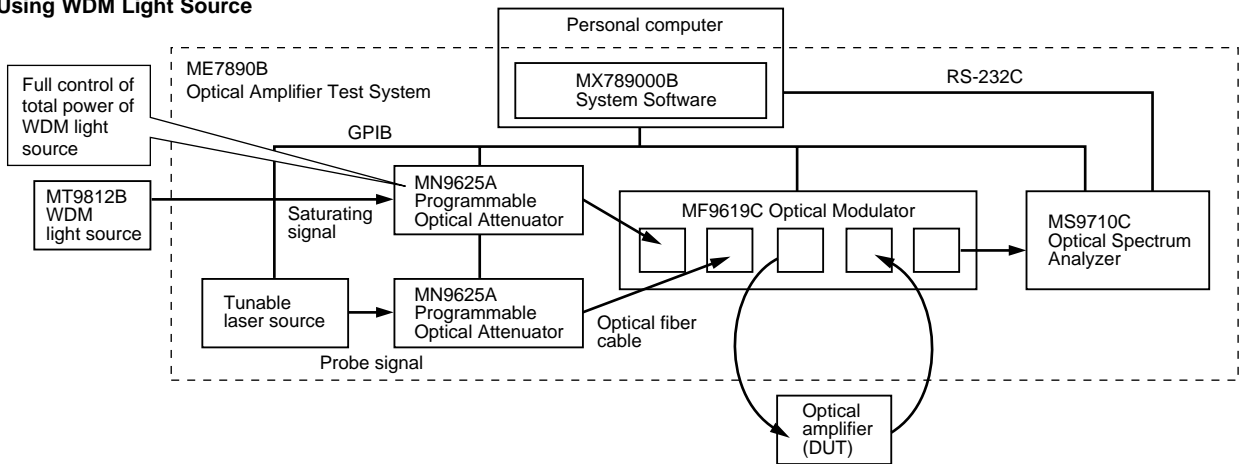

• Using MS9710C SLD light source output (option) as the probe light signal

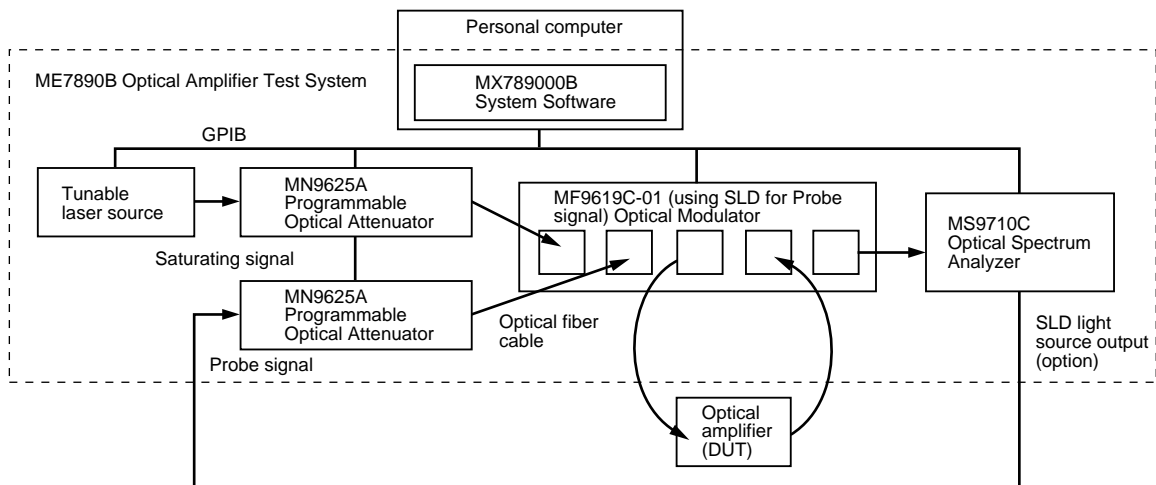

When a wide-band light source such as an SLD is used as the probe light source, specify the MF9619C (Option 01: using SLD for probe signal) with a small loss for the probe light input port. However, EDFAs saturation input level is reduced by 3 dB.

• Pulse method

High-accuracy measurement*1

The pulse method is the most highly accurate measurement for NF and gain. In the pulse method, the on/off extinction ratio of the optical modulator is better than 65 dB, which causes almost no error in measuring the ASE level as a result of leakage of the amplified optical signal. In addition, the ASE level is measured directly, so there is no deviation from the actual noise gap resulting from measurement using the fitting method. The polarization dependency and the insertion loss are both optimized and the method has excellent reliability. In the following diagram, the measured spectrum is expanded, and the measured ASE spectrum can be observed with almost no error.

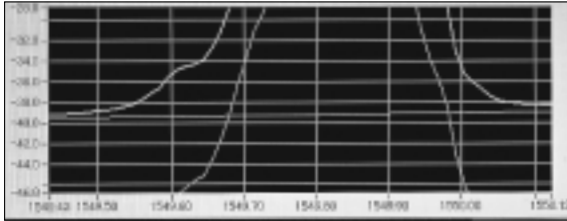

*1: Considering fiber connection/disconnection reproducibility at calibration, power meter measurement level accuracy, optical spectrum analyzer (OSA) wavelength flatness/level linearity/resolution accuracy, optical switch switching reproducibility, optical switch and OSA polarization dependency, measured wavelength accuracy.

The NF accuracy is found from the following equation for the error of part and the total error is estimated by the RSS method.

$$NF = \frac{P_{ase} \times \lambda^3}{h \times c^2 \times RES \times G} + \frac{1}{G}$$

where, P_{ase} = ASE level of signal wavelengths, h = Planck's constant, RES = OSA resolution, λ = Wavelength, c = Velocity of light in a vacuum, G = Optical amplifier gain

Measurement example

The following diagrams show a measurement example using a 16-channel WDM light source (top: spectrum display, bottom: gain and NF profile display).

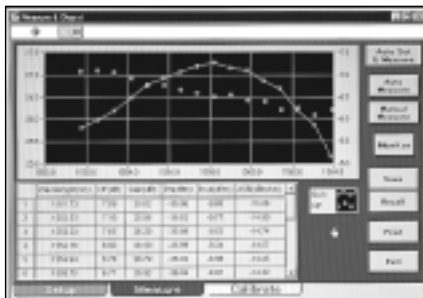

System setup

When measuring using the pulse method, the system controls the MS9710C Optical Spectrum Analyzer and the MF9619C Optical Modulator. A WDM light source can also be used. At measurement start, the wavelength of each channel is detected and the NF and gain of each channel is measured automatically.

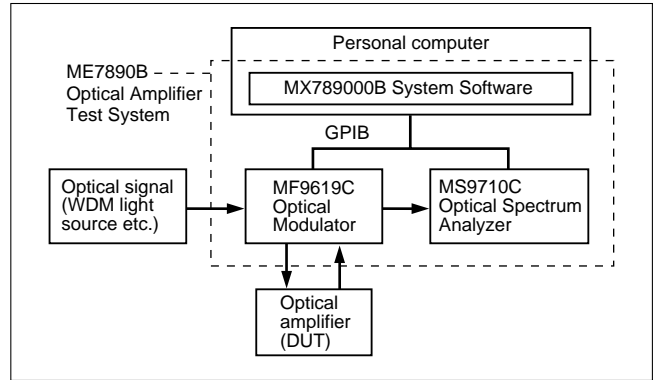

Automatic setting of wavelength and power

When the tracking function is used, the tunable laser source and programmable optical attenuator are controlled. The NF and gain are measured automatically using a matrix as the wavelength and level are varied.

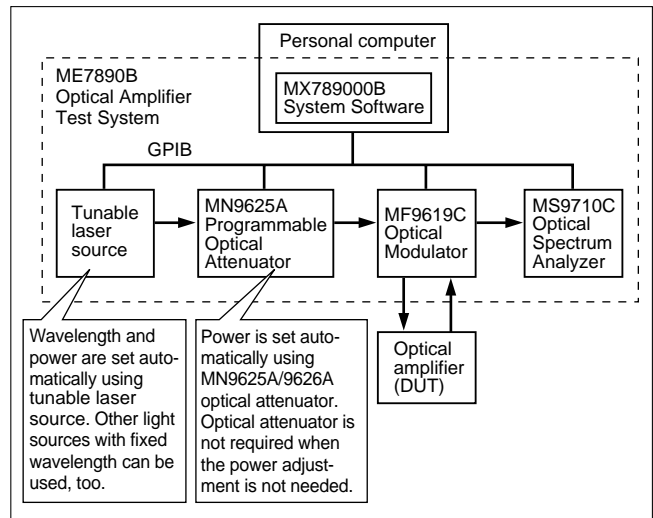

System setup

Specifications

• ME7890B Optical Amplifier Test System

To ensure that the system operates with good stability, warm it up for about 20 minutes. The following specifications were obtained after a 2-hour warm up period.

Measurement wavelength	1530 to 1620 nm (guaranteed range), 1525 to 1635 (measurable range)
Input level range	Input signal (INPUT SATURATING SIGNAL port): -40 to +10 dBm/nm (MS9710C attenuator: off), -25 to +20 dBm/nm (MS9710C attenuator: on) Input port of EDFA output (B from EDFA port): +10 dBm/nm (MS9710C attenuator: off), +23 dBm/nm (MS9710C attenuator: on)
NF measurement accuracy*1	≤0.3 dB (1530 to 1570 nm), ≤0.4 dB (1570 to 1620 nm) *After calibration, temp. change: within ±3°C, modulation frequency: 125/250 kHz, pulse measurement method
NF measurement reproducibility	≤0.2 dB *After calibration, temp. change: within ±3°C, modulation frequency: 125/250 kHz, pulse measurement method
Gain measurement accuracy	≤0.125 dB
Gain measurement reproducibility	≤0.1 dB
Measurement channel number	1 to 256 channel
Minimum channel interval	0.4 nm (50 GHz)
Functions	Calibration, data save/recall, printout
Measurement modes	Normal by WDM light source (1 to 256 channel, pulse method), matrix of level vs. wavelength by tunable laser source tracking, pulse probe
Measurement results displays	Normal mode: Spectrum (Pin, Pout, ASE), measurement result table, NF/gain profile Tunable laser source operation mode: (Wavelength, input power, output power) vs. (NF, gain, input power, output power, ASE power), spectrum, table Probe measurement mode: X axis (Wavelength, input power, saturating signal power, saturating signal wavelength) vs. Y axis (NF, gain, input power, output power, ASE power), spectrum
Power	85 to 132/170 to 250 Vac, 47.5 to 63 Hz, ≤800 VA
Dimensions and mass	550 (W) x 1792 (H) x 700 (D) mm, ≤250 kg
Temperature and humidity	Temperature: 0° to +40°C (operating), -20° to +60°C (storage) Humidity: ≤90% (no condensation)

*1: Using master cord (J0846B) guaranteed at calibration and measurement

The NF value is not measured directly. Since direct evaluation is not possible, the measurement error is specified for the required all items. Each error is mutually independent and the final NF error is determined by averaging the sum of squares.

The details of the NF measurement accuracy are as follows:

ASE Level measurement accuracy:

±0.255 dB (including reproducibility due to fiber connection/disconnection at calibration, error after calibration of level accuracy with power meter with level accuracy of better than 2.2%, level linearity, and optical switch switching reproducibility)

Gain (I/O) measurement accuracy: ±0.125 dB (including level linearity, polarization dependency, optical switch switching reproducibility)

Wavelength resolution accuracy: ±0.1 dB (MS9710C: 1530 to 1570 nm), ±0.2 dB (MS9710C: 1570 to 1620 nm)

Measured wavelength accuracy: ±0.0001 dB (MS9710C)

• MF9619C Optical Modulator

Insertion loss (25°C)	Saturating signal: ≤10 dB (1530 to 1630 nm), ≤9.5 dB (1630 to 1570 nm, Option 02) *Between [INPUT SATURATION SIGNAL] and [A to EDFA] ports Probe signal: ≤14 dB (1530 to 1630 nm) *Between [INPUT PROBE SIGNAL] and [A to EDFA] ports
Modulation extinction ratio	≥65 dB (25°C, at 125/250 kHz modulation)
EMC	EN55011: 1991, Group 1, Class A EN50082-1: 1992 Harmonic current emissions: EN61000-3-2 (1995)
Safety	EN61010-1: 1993 (Installation Category II, Pollution Degree II)
Power supply	85 to 132/170 to 250 Vac, 47.5 to 63 Hz, ≤100 VA
Dimensions and mass	320 (W) x 132.5 (H) x 350 (D) mm, ≤8 kg
Temperature and humidity	Temperature: 0° to +40°C (operating), -20° to +60°C (storage) Humidity: ≤90% (no condensation)

• Recommended controller

Hardware	PC-AT compatible computer running Windows® 3.1/95/98*2
CPU, memory, display, OS	Pentium® 75 MHz or faster, ≥16 MB (≥32 MB recommended), 640 x 480 or better resolution, Microsoft® Windows® operating system Version 3.1, Windows 95 operating system or Windows 98 operating system
Memory drives	HDD with at least 20 MB free space, 3.5 inch FDD (2 HD, 1.44 MB)
GPIB, RS-232C	National Instruments product, one port (when using tunable laser source as probe light source)

*2: Microsoft® Windows® operating system Version 3.1, Microsoft® Windows® 95 operating system or Microsoft® Windows® 98 operating system are registered trademarks of Microsoft Corporation (USA).

• Refer to the relevant manuals for the specifications of the equipment listed below.

MS9710C Optical Spectrum Analyzer, Tunable laser source, MN9625A/9626A Programmable Optical Attenuator

Ordering information

Please specify model/order number, name, and quantity when ordering.

Model/Order No.	Name
ME7890B	System Optical Amplifier Test System
	Standard configuration*1
	Tunable Laser Source: 2 sets
MN9625A	Programmable Optical Attenuator*2: 2 sets
MF9619C	Optical Modulator (includes MX789000B Software for Optical Amplifier Test System Control): 1 set
MS9710C	Optical Spectrum Analyzer: 1 set
B0422A	System rack (for 100 V system): 1 pc
B0423B	Rack mount kit (for tunable laser source): 2 pc
B0390F	Rack mount kit (for two MN9625A): 1 pc
B0424A	Rack mount kit (for MF9619C): 1 pc
B0423A	Rack mount kit (for MS9710C): 1 pc
	Standard accessories
W1697AE	ME7890B/MF9619C operation manual: 1 copy
	Application parts
J0654A	RS-232C cable (9P-9P)*3
J0007	GPIB cable, 1 m*3
J0008	GPIB cable, 2 m*3
J0846B	FC · PC(MASTER)-FC · PC-2M-SM*4
J0057	FC adapter*4
J0847A	FC-ST conversion adapter
J0848A	FC-DIN conversion adapter
J0849B	FC-SC conversion adapter
J0850A	FC-HMS-10/A conversion adapter
J0635B	FC · PC-FC · PC-2M-SM
J0757B	FC · PC-ST · PC-2M-SM
J0760B	FC · PC-DIN · PC-2M-SM
J0692B	FC · PC-SC · PC-2M-SM
J0763B	FC · PC-HMS-10/A · PC-2M-SM
J0617B	Replaceable optical connector (FC)
J0618D	Replaceable optical connector (ST)
J0618E	Replaceable optical connector (DIN)
J0618F	Replaceable optical connector (HMS-10/A)
J0619B	Replaceable optical connector (SC)
Z0282	Ferrule cleaner
Z0283	Tape for Ferrule cleaner (6 pcs/set)
Z0284	Adapter cleaner (200 pcs/set)
J0655A	RS-232C cable (9P-2P)
B0422B	System rack (for 200 V system, C7 plug)
B0422C	System rack (for 200 V system, B4 plug)
B0390E	Rack mount kit (for 1 MN9625A)
	Main frame
MF9619C	Optical Modulator
	Standard accessories
	Power cord, 2.5 m: 1 pc
F0012	Fuses, 3.15 A (for 100/200 V system): 2 pcs
B0329F	Front cover (3/4MW 4U): 1 pc
MX789000B	Software for Optical Amplifier Test System Controller (for Windows 3.1/95/98): 1 set
	Options
MF9619C-01	Using SLD for probe signal
MF9619C-38	ST connector
MF9619C-39	DIN connector
MF9619C-40	SC connector
MF9619C-43	HMS-10/A connector
	Application part
B0424	Rack mount kit (for MF9619C)

*1: Only the required instruments can be selected and ordered from the standard configuration.

*2: The MN9626A Programmable Optical Attenuator can also be used.

*3: The full system (standard) requires five 1 m GPIB cables, one 2 m GPIB cable, and one RS-232C cable.

The RS-232C cable is required when using a tunable light source as the probe light source.

Consult Anritsu for the number required by the system setup.

*4: When measuring NF with an accuracy of ± 0.3 dB, six master cords (J0846B) and five adapters are required.

Note: For personal computer, please contact your nearest Anritsu representative.

OPTICAL CHANNEL SELECTOR MN9662A/9664A/9672A/9674A

1.2 to 1.65 μm

For Automatic Switching of Optical Paths



The MN9662A/9664A/9672A/9674A are channel selectors for outputting the optical signal input to the common channels to any output channel. GPIB and RS-232C interfaces are provided as standard equipment, and the selector can also be controlled by the MT9810A Optical Test Set. These functions are available to construct an automatic measurement system.

The selector is ideal for R&D and quality evaluation of transmission equipment and devices using EDFAs, such as trunk optical trans-

mission systems, optical CATV analog transmission systems, WDM transmission systems, etc. Various models are available to match the required number of channels.

Features

- Low polarization-dependent Loss (0.03 dBp-p: MN9662A/9664A)
- Cleanable and replaceable optical adapters (FC, SC, ST, DIN, HMS-10/A)

Specifications

Typical values are given for reference only to assist in the use of these instruments, and are not guaranteed specifications.

Model	MN9662A	MN9664A	MN9672A	MN9674A
Number of channels	1 x 8	1 x 16	2 x 8	2 x 16
Wavelength	1.2 to 1.65 μm			
Applicable optical fiber	SM (ITU-T G.652)			
Insertion loss*1, *2	≤ 1.6 dB (1.1 dB typ.)		≤ 2.5 dB (2.0 dB typ.)	
Return loss*3	≥ 45 dB (PC connector)			
Polarization dependent loss*1	≤ 0.03 dBp-p (0.015 dBp-p typ.)*4		≤ 0.05 dBp-p (0.025 dBp-p typ.)*5	
Crosstalk	≤ -80 dB			
Switching repeatability*6	≤ 0.02 dBp-p (0.003 dBp-p typ.)			
Switching time	Min.*7	≤ 600 ms		
	Max.	≤ 800 ms*8	≤ 1100 ms*9	≤ 800 ms*8
Switching life	$\geq 1 \times 10^7$ times			
Max. input level	+23 dBm (200 mW)			
I/O optical connector	FC, SC, ST, DIN, HMS-10/A (all PC type)			
Temperature range	Operating: 0° to 50 °C, Storage: -30° to +71 °C			
Remote control	GPIB, RS-232C (D-sub 9-pin), control by MT9810A			
Power	85 to 132/170 to 250 Vac, ≤ 35 VA, 47.5 to 63 Hz			
Dimensions and mass	213 (W) x 88 (H) x 351 (D) mm, ≤ 4.5 kg			
EMC	-		EN61326: 1997/A1, 1998 (Class A) EN61000-3-2: 1995/A2, 1998 (Class D) EN61326: 1997/A1, 1998 (Annex A)	
LVD	-		EN610101-1: 1993/A2, 1995 (Installation Category II, Pollution degree 2)	

*1: Specifications measured using master optical fiber cable
 *2: Including connector loss at 2 points at 1.31 and 1.55 μm
 *3: Return loss depends on connected connector, using PC connector at ≥ 50 dB return loss at 1.31 and 1.55 μm
 *4: At constant temperature in operating temperature range at 1.31 and 1.55 μm
 *5: At constant temperature in operating temperature range at 1.55 μm

*6: At constant temperature in operating temperature range and constant polarization condition
 *7: Between channel 1 and channel 2
 *8: Between channel 7 and channel 8
 *9: Between channel 15 and channel 16
 Note: Please contact us for 1 x 24, 2 x 24, 1 x 32 and 2 x 32 optical channel selectors.

Ordering information

Please specify model/order number, name, and quantity when ordering.

Model/Order No.	Name
Main frame	
MN9662A	Optical Channel Selector (1 x 8 channels)
MN9672A	Optical Channel Selector (2 x 8 channels)
MN9664A	Optical Channel Selector (1 x 16 channels)
MN9674A	Optical Channel Selector (2 x 16 channels)
Standard accessories	
	Power cord: 1 pc
F0008	Fuse, 1 A (for 100/200 V mains): 2 pcs
Z0397A	FC adapter caps*1: 1 pc
B0329L	Front cover: 1 pc
W1489AE	MN9662A/9672A/9664A/9674A operation manual: 1 copy
Options	
MN9662A/9664A-37	FC-PC connector (with FC adapter cap)*2
MN9672A/9674A-37	FC-PC connector (with FC adapter cap)*2
MN9662A/9664A-38	ST connector (with ST adapter cap)*2
MN9672A/9674A-38	ST connector (with ST adapter cap)*2
MN9662A/9664A-39	DIN connector (with DIN adapter cap)*2
MN9672A/9674A-39	DIN connector (with DIN adapter cap)*2
MN9662A/9664A-40	SC connector (with SC adapter cap)*2
MN9672A/9674A-40	SC connector (with SC adapter cap)*2
MN9662A/9664A-43	HMS-10/A connector (with HMS-10/A adapter cap)*2
MN9672A/9674A-43	HMS-10/A connector (with HMS-10/A adapter cap)*2
Application parts	
J0617B	Replaceable optical adapter (FC-PC)
J0618D	Replaceable optical adapter (ST)
J0618E	Replaceable optical adapter (DIN)
J0618F	Replaceable optical adapter (HMS-10/A)
J0619B	Replaceable optical adapter (SC)
Z0397A	FC adapter cap
Z0411A	ST adapter cap
Z0412A	DIN adapter cap
Z0413A	SC adapter cap
Z0414A	HMS-10/A adapter cap
J0635B	Optical fiber cord (FC-PC connector), 2 m
Z0282	Ferrule cleaner
Z0283	Ferrule cleaner spare tape (6 pcs/set)
Z0284	Adapter cleaner (stick type, 200 pcs/set)
J0006	GPIB cable, 0.5 m
J0007	GPIB cable, 1 m
J0008	GPIB cable, 2 m
J0009	GPIB cable, 4 m
J0654A	RS-232C cable (9P-9P)
J0655A	RS-232C cable (9P-25P)
J0897B	MT9810A connection cable, 1 m
J0897C	MT9810A connection cable, 2 m
J0897D	MT9810A connection cable, 5 m
J0897E	MT9810A connection cable, 10 m

*1: Number differs according to model

MN9662A: 9 pcs; MN9672A: 10 pcs; MN9664A: 17 pcs; MN9674A: 18 pcs

*2: Standard connector for specified option. If not specified, FC-PC connector (Option 37) supplied as standard.

PROGRAMMABLE OPTICAL ATTENUATOR
MN9625A/9626A

1.2 to 1.65 μm

*High Attenuation Accuracy, Low Polarization Dependent Loss,
 Excellent Wavelength Flatness*

NEW



CE **GPIB**

The MN9625A/9626A Programmable Optical Attenuator has excellent attenuation accuracy. It is calibrated with a high-accuracy calibration system over an attenuation range of 0 to 60 dB. The MN9625A has a superior wavelength flatness of 0.2 dBp-p max. by using an attenuation element with very flat wavelength characteristics. It is the ideal instrument for evaluating WDM (wavelength division multiplexing) optical amplifiers in which gain flatness vs. wavelength is an important factor. Moreover, the MN9626A has a built-in optical monitor output for monitoring the level of through light.

Features

- Attenuation accuracy of ± 0.05 dB (typical)
- Wavelength flatness of 0.1 dBp-p (typical, 1.52 to 1.57 μm , MN9625A)
- Low polarization dependent loss of 0.05 dBp-p max. (MN9625A)
- Return loss of 45 dB min. (PC connector) and 60 dB min. (APC: Angled PC connector)
- Removable optical connector for easy cleaning and replacement

Applications

- R&D and manufacturing of WDM optical amplifiers — Adjusting input optical level, evaluating gain flatness
- R&D and manufacturing of optical transmission systems — Adjusting optical output and reception optical levels, testing error rates
- R&D and manufacturing of optical components — Measuring optical fiber amplifier I/O and wavelength characteristics, measuring optical loss of isolators, etc.

Typical characteristics

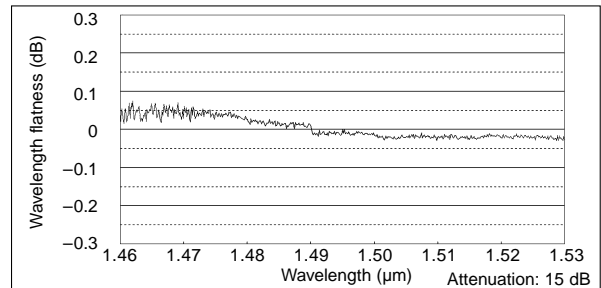

Wavelength flatness: 1.46 to 1.53 μm (MN9625A)

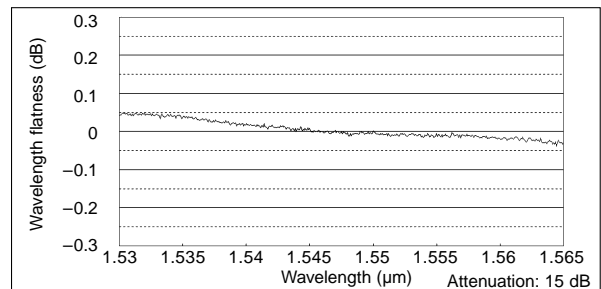

Wavelength flatness: 1.53 to 1.565 μm (MN9625A)

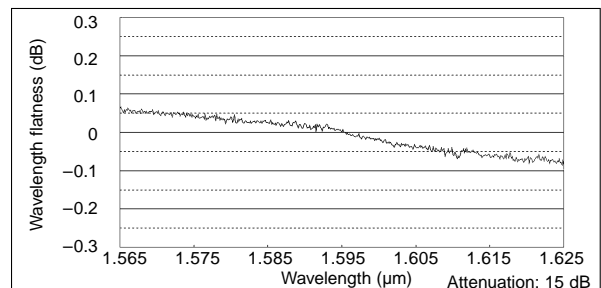

Wavelength flatness: 1.565 to 1.625 μm (MN9625A)

Specifications

(Specifications at 1.31/1.55 μm measured using master optical fiber cord. Typical values are not guaranteed.)

Model	MN9625A	MN9626A
Wavelength range	1.2 to 1.65 μm	
Applicable optical fiber	SM fiber (ITU-T G.652)	
Maximum attenuation	60 dB (except insertion loss)	
Display resolution	0.01 dB	
Attenuation accuracy	±0.1 dB (typical: ±0.05 dB)	
Polarization dependent loss	≤0.05 dBp-p (typical: 0.03 dBp-p)	≤0.1 dBp-p (typical: 0.07 dBp-p)
Wavelength flatness*1	≤0.2 dBp-p (1.46 to 1.53 μm) ≤0.2 dBp-p (1.53 to 1.565 μm) ≤0.25 dBp-p (1.565 to 1.625 μm)	–
Insertion loss	≤2.8 dB (typical: 1.8 dB)	≤4.2 dB*2
Switching repeatability	±0.01 dB*3 (typical: ±0.005 dB)	
Switching time	≤150 ms (attenuation variation: 0.01 dB), ≤500 ms (attenuation variation: 60 dB)	
I/O crosstalk	≤–80 dB (shutter closed)	
Return loss	≥45 dB (PC connector)*4, ≥60 dB (APC connector)*5	
Optical monitor output*6	Output ratio	10:1
	Loss difference	≤19.0 dB
	Output stability	≤0.1 dB
	Crosstalk attenuation	≥40 dB
I/O connector	PC*7: FC, SC, DIN, ST, HMS-10/A APC*8: FC, SC, HRL-10	
Maximum input level	18 dBm (63 mW)	
Operating temperature range	0 to 50°C	
Power*9	85 to 132 Vac, 170 to 250 Vac, 47.5 to 63 Hz, ≤45 VA	
Dimensions and mass	132.5 (H) x 213 (W) x 351 (D) mm, ≤6.5 kg	
EMC	EN61326: 1997/A1, 1998 (Class A) EN61000-3-2: 1995/A2, 1998 (Class D) EN61326: 1997/A1, 1998 (Annex A)	
LVD	EN610101-1: 1993/A2, 1995 (Installation Category II, Pollution degree 2)	

*1: Attenuation range of 0 to 30 dB

*2: Including optical fiber coupler loss

*3: At constant temperature in operating temperature range

*4: Depends on connector (using PC connector with return loss of 48 dB min.)

*5: Depends on connector (using APC connector with return loss of 63 dB min.)

*6: Between output and optical monitor output

*7: User replaceable (One connector type supplied as standard accessory. When connector type is not specified in the order, FC connectors are supplied.)

*8: Factory option, attachable/detachable front shell

*9: Specify 100 Vac or 200 Vac system when ordering (factory setting only).

Ordering information

Please specify model/order number, name, and quantity when ordering.

Model/Order No.	Name
MN9625A MN9626A	Main frame Programmable Optical Attenuator Programmable Optical Attenuator (with optical monitor output)
W1834AE	Standard accessories MN9625A/9626A operation manual: 1 copy
F0010	Power cord, 2.5 m: 1 pc Fuse, 1.6 A: 2 pcs
MN9625A/9626A-38 MN9625A/9626A-39 MN9625A/9626A-40 MN9625A/9626A-43 MN9625A/9626A-25	Options ST connector (both input and output) DIN connector (both input and output) SC connector (both input and output) HMS-10/A connector (both input and output) FC (APC) connector (both input and output, factory option)
MN9625A/9626A-26	SC (APC) connector (both input and output, factory option)
MN9625A/9626A-47	HRL-10 (APC) connector (both input and output, factory option)
Z0513A*1 Z0513B*1 Z0513C*1	Optional accessories Optical fixed attenuator [FC (PC)] Optical fixed attenuator [SC (PC)] Optical fixed attenuator [ST (PC)]

Model/Order No.	Name
B0390E	Rack mount kit (inch type, for 1 unit, left side)
B0390F	Rack mount kit (inch type, for 2 units, side-by-side)
B0329M	Front cover (1/2MW3U)
J0575	Optical fiber cord (PC connector at both ends, for SM fiber), 2 m
J0617B	Replaceable optical connector (FC) *For PC connector
J0618D	Replaceable optical connector (ST) *For PC connector
J0618E	Replaceable optical connector (DIN) *For PC connector
J0619B	Replaceable optical connector (SC) *For PC connector
J0618F	Replaceable optical connector (HMS-10/A) *For PC connector
J0739A	Replaceable optical connector (FC) *For APC connector
J0739C	Replaceable optical connector (SC) *For APC connector
J0739D	Replaceable optical connector (HRL-10) *For APC connector
Z0282	Ferrule cleaner
Z0283	Replacement reel for ferrule cleaner (6 pcs/set)
Z0284	Cleaner for optical adapter (stick type, 200 pcs/set)

*1: Attenuation: 6 dB ±1 dB, Maximum input level: +23 dBm, Return loss: ≥55 dB

E/O, O/E CONVERTER
MP9677B
 10 Gbit/s

For STM-64, OC-192 or FEC Jitter Evaluation



MP9677B is the 10 Gbit/s E/O and O/E converter for STM-64, OC-192 or FEC jitter evaluation and BER measurement. It has a jitter bandwidth of 80 MHz, and can measure jitter tolerance, jitter transfer, and output jitter at 10 Gbit/s optical interface when used with MP1777A. It can be also used with MP1570A.

Functions

• **SDH/SONET network test**

Measurements such as jitter tolerance, jitter transfer, output jitter, and BER at 9.95328 Gbit/s optical interface are available. These measurements can be performed manually, with no need for a personal computer.

• **FEC test**

Measurements such as jitter tolerance, jitter transfer, output jitter, and error at 10.66423 Gbit/s optical interface are available. These measurements can be performed manually, with no need for a personal computer.

Specifications

• **MP9677B E/O, O/E Converter**

Bit rate	2.4 to 11 Gbit/s (typical)
Optical signal output	Level: -5 dBm ±3 dBm (average power) Output waveform: NRZ Wavelength: 1545 nm ±20 nm (any one wavelength within range*1) Wavelength width: ≤1 nm (20 dB down point) Side mode suppression ratio: ≥30 dB Extinction ratio: ≥10 dB Connector: FC-SPC*2 (single mode fiber)
Electrical signal input	Data level: 0 V ±0.3 V(V _H)/-1 V ±0.3 V(V _L), 50 Ω Output waveform: NRZ Clock level: 1 V(p-p) ±0.3 V, 50 Ω Connector: SMA Phase adjustable range: ≥100 ps

Optical signal input	Sensitivity Wide: -11 to -5 dBm, Narrow: -11 to -3 dBm Input waveform: NRZ Wavelength: 1480 to 1580 nm Maximum input level: 0 dBm (average power) Return loss: ≥20 dB Connector: FC-SPC*2 (single mode fiber)
Electrical signal output	Data level: 0 V ±0.2 V(V _H)/-1 V ±0.2 V(V _L), 50 Ω Output waveform: NRZ Clock level: 1 V(p-p) ±0.33 V, 50 Ω Connector: SMA Phase adjustable range: ≥100 ps
External optical input*3 (Option 01)	Maximum input level: +10 dBm Wavelength: 1530 to 1570 nm (guaranteed range)
Others	Through data input: 0 V ±0.3 V(V _H)/-1 V ±0.3 V(V _L), 50 Ω Retiming clock input: 1 V(p-p) ±0.3 V, 50 Ω Internal phase adjustable range: ≥100 ps Reshaped data output: 0 V ±0.2 V(V _H)/-1.5 V ±0.2 V(V _L), 50 Ω Connector: SMA
Dimensions and mass	426 (W) x 177 (H) x 450 (D) mm, ≤20 kg (including clock recovery unit)
Power	AC 85 to 132 V/170 to 250 V (auto-switching), 47 to 63 Hz, ≤300 VA (including clock recovery unit)
Environmental condition	Operating temperature: +10° to +40°C, Storage temperature: -20° to +60°C, Humidity: 40 to 90%
EMC	EN61326: 1997/A1, 1998 (Class A) EN61000-3-2: 1995/A2, 1998 (Class A) EN61326: 1997/A1, 1998 (Annex A)
LVD	EN610101-1: 1993/A2, 1995 (Installation Category II, Pollution degree 2)

*1: When ordering, the option specified connector is supplied as standard.
 *2: User replaceable
 *3: Using this with the application parts' polarization rotating module is recommended.

• **MU967701A/967702A Clock Recovery Unit**

Data input	Reshaped data input Bit rate: 9.95328 Gbit/s ± 50 ppm (MU967701A), 10.66423 Gbit/s ± 50 ppm (MU967702A) Level: 0.5 to 1.5 V(p-p), 50 Ω Input waveform: NRZ Connector: SMA																								
Data output	Through data output Bit rate: 9.95328 Gbit/s ± 50 ppm (MU967701A, depend on input signal), 10.66423 Gbit/s ± 50 ppm (MU967702A, depend on input signal) Level: 0 V ± 0.2 V(V_H)/-1 V ± 0.2 V(V_L), 50 Ω Output waveform: NRZ Connector: SMA																								
Clock output	Retiming clock output, monitor clock output Frequency: 9.95328 GHz ± 50 ppm (MU967701A, depend on input signal), 10.66423 GHz ± 50 ppm (MU967702A, depend on input signal) Level: 1 V(p-p) ± 0.2 V, 50 Ω Connector: SMA																								
Jitter tolerance*1	<table border="1" style="margin-left: 20px;"> <tr><td>A1</td><td>A2</td><td>A3</td></tr> <tr><td>0.2 UIp-p</td><td>2 UIp-p</td><td>2490 UIp-p</td></tr> </table> <table border="1" style="margin-left: 20px;"> <tr><td>f6 (Hz)</td><td>f7 (Hz)</td><td>f1 (Hz)</td><td>f2 (Hz)</td><td>f3 (Hz)</td><td>f4 (Hz)</td></tr> <tr><td>10</td><td>12.1</td><td>20k</td><td>400k</td><td>4M</td><td>80M</td></tr> </table>	A1	A2	A3	0.2 UIp-p	2 UIp-p	2490 UIp-p	f6 (Hz)	f7 (Hz)	f1 (Hz)	f2 (Hz)	f3 (Hz)	f4 (Hz)	10	12.1	20k	400k	4M	80M						
A1	A2	A3																							
0.2 UIp-p	2 UIp-p	2490 UIp-p																							
f6 (Hz)	f7 (Hz)	f1 (Hz)	f2 (Hz)	f3 (Hz)	f4 (Hz)																				
10	12.1	20k	400k	4M	80M																				
Jitter transfer characteristics	<p>Wide mode</p> <table border="1" style="margin-left: 20px;"> <tr><td>A1</td><td>A2</td><td>A3</td><td>A4</td><td>f1</td><td>f2</td><td>f3</td></tr> <tr><td>1.5 dB</td><td>-1.5 dB</td><td>3.5 dB</td><td>-3.5 dB</td><td>100 Hz</td><td>10 MHz</td><td>80 MHz</td></tr> </table> <p>Narrow mode</p> <table border="1" style="margin-left: 20px;"> <tr><td>A1</td><td>A2</td><td>f1</td><td>f2</td><td>f3</td></tr> <tr><td>0.1 dB</td><td>-19.9 dB</td><td>100 Hz</td><td>8 MHz</td><td>80 MHz</td></tr> </table>	A1	A2	A3	A4	f1	f2	f3	1.5 dB	-1.5 dB	3.5 dB	-3.5 dB	100 Hz	10 MHz	80 MHz	A1	A2	f1	f2	f3	0.1 dB	-19.9 dB	100 Hz	8 MHz	80 MHz
A1	A2	A3	A4	f1	f2	f3																			
1.5 dB	-1.5 dB	3.5 dB	-3.5 dB	100 Hz	10 MHz	80 MHz																			
A1	A2	f1	f2	f3																					
0.1 dB	-19.9 dB	100 Hz	8 MHz	80 MHz																					
Environmental condition	Same as MP9677B (main frame)																								

*1 MP9677B: Wide mode, -8 to -6 dBm input level, 10° to 30°C
 MU967701A: SDH internal, VC4-64c-Bulk, PRBS 2²³ - 1 used with MP1570A and MU150000A
 MU967702A: PRBS 2²³ - 1 used MP1763C/1764C

Ordering information

Please specify model/order number, name, and quantity when ordering.

Model/Order No.	Name
MP9677B	Main frame
MU967701A	E/O, O/E Converter
MU967702A	Clock Recovery Unit (9.95328 Gbit/s)
	Clock Recovery Unit (10.66423 Gbit/s)
	Standard accessories
F0014	AC power cord: 1 pc
J0900E	Fuse, 6.3 A: 2 pcs
W1765AE	Coaxial cord: 4 pcs
W1710AE	MP9677B operation manual: 1 copy
	MU967701A operation manual (supplied to MU967701A): 1 copy
W1761AE	MU967702A operation manual (supplied to MU967702A): 1 copy
B0329C	Front cover: 1 pc
E0008A	Optical output control key: 2 pcs
J0995	U link (for connection with MU967701A or MU967702A): 3 pcs
	Options
MP9677B-01	External optical input function (external light source usable)
MP9677B-10	E/O converter minus option
MP9677B-38	ST connector
MP9677B-39	DIN connector
MP9677B-40	SC connector
MP9677B-43	HMS-10/A connector

Model/Order No.	Name
	Peripheral instruments
MP1777A	10 GHz Jitter Analyzer
MS4630B	Network Analyzer (10 Hz to 300 MHz, with Option 10)
MP1763C	Pulse Pattern Generator (12.5 Gbit/s)
MP1764C	Error Detector (12.5 Gbit/s)
MP1570A	SONET/SDH/PDH/ATM Analyzer (with MU150000A)
	Application parts
J0796A	ST connector (user replaceable, with protective cap, 1 set)
J0796B	DIN connector (user replaceable, with protective cap, 1 set)
J0796C	SC connector (user replaceable, with protective cap, 1 set)
J0796D	HMS-10/A connector (user replaceable, with protective cap, 1 set)
J0796E	FC connector (user replaceable, with protective cap, 1 set)
Z0478	Polarization rotating module (for MP9677B-01)
J0747A	Fixed optical attenuator (5 dB)
J0635B	SM optical fiber cord (both-ends FC-SPC connector), 2 m

OPTICAL DIRECTIONAL COUPLER
MN9604C
 1.25 to 1.65 μm

For High-Accuracy Measurement of Optical Connector Return Loss

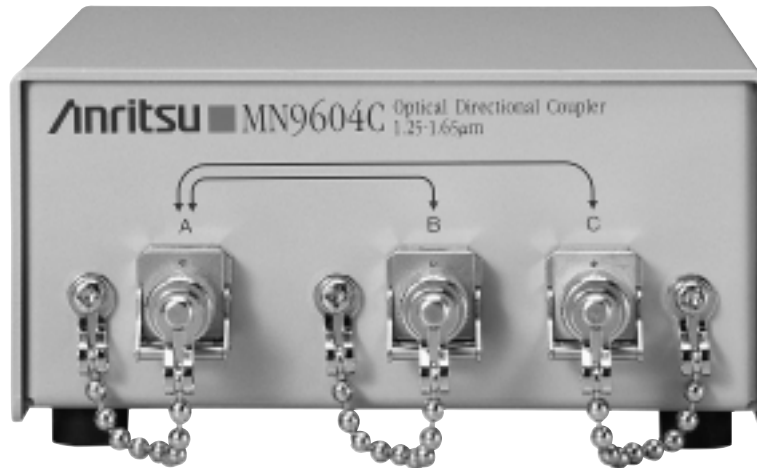

The MN9604C is used in combination with stabilized light source and optical power meter to measure optical return loss of optical connectors at approx. 50 dB.

Specifications

Compatible fiber	SM (10/125 μm , NA 0.1)
Wavelength range	1.25 to 1.65 μm
Insertion loss	<5.5 dB (1.31/1.55 μm : <5.0 dB, between ports A to B and ports A to C)
Loss difference between ports	<2.2 dB (1.31/1.55 μm : <1.5 dB, between ports A to B and ports A to C)
Insertion loss polarization dependency	<0.15 dB*1
Crosstalk attenuation	>54 dB*1,*2
Optical connector	FC, SC, ST, DIN, HMS-10/A
Ambient temperature, rated range of use	0° to +50°C
Storage temperature	-40° to +71°C
Dimensions and mass	110 (W) x 52 (H) x 121 (D) mm, \leq 500 g

*1: Wavelength: 1.31/1.55 μm

*2: When using the connector with return loss of >53 dB

Ordering information

Please specify model/order number, name and quantity when ordering.

Model/Order No.	Name
MN9604C	Main frame Optical Directional Coupler (for SM fiber)
W1563AE	Standard accessories MN9604C operation manual: 1 copy
MN9604C-37 MN9604C-38 MN9604C-39 MN9604C-40 MN9604C-43	Optical connectors FC/PC connector ST connector DIN connector SC connector HMS-10/A (DIAMOND) connector
J0441	Optional accessories Total internal reflection fiber cord, 1 m (with FC · PC connector)
J0617B	Replaceable optical connector (FC)
J0618D	Replaceable optical connector (ST)
J0618E	Replaceable optical connector (DIN)
J0618F	Replaceable optical connector (HMS-10/A)
J0619B	Replaceable optical connector (SC)
Z0282	Ferrule cleaner (Cletop A-type, 1 pc)
Z0283	Ferrule cleaner spare tape (6 pcs/set)
Z0284	Adapter cleaner (stick type, 200 pcs/set)

OPTICAL CHANNEL DROP UNIT (OCDU)
MN9320A
 1528 to 1565 nm



The technique of Dense Wavelength Division Multiplexing is well established and adopted worldwide as a means of increasing the traffic carrying capacity of a fiber. Optical cross connects, wavelength routing and translation, now make a typical network far more complex in construction. Identification of an individual channel and verification of the data passing over it during installation, commissioning and routine maintenance as part of a Service Level Agreement (SLA) is becoming more critical. The MN9320A Optical Channel Drop Unit is a test instrument that scans the DWDM optical signal and displays all those channels present in the form of a bar graph or a tabulation of channel and power. Any individual channel can be selected from this display and fed to its output port which can then be connected to a protocol analyzer such as the Anritsu MP1570A for data validation and testing. Wherever the integrity of a DWDM signal must be verified, the MN9320A can be used.

Features

Independent DWDM signal access for channels of 50 GHz spacing or higher up to data rates of 10 Gbps.

- ±10pm wavelength accuracy (typical)
- ITU-T 50 GHz, 100 GHz or custom grid capability
- Provides DWDM channel access to any BER tester
- Measurement of channel wavelength and power
- Optical output protection mode

Proof of conformance to a customer SLA, isolation of points of failure or performance degradation in a DWDM network can be achieved by connecting the MN9320A to a monitor point in the network and connecting it to a Data Analyzer such as the Anritsu MP1570A. Any of the individual DWDM channel signals can then be directed to the input of the BERT for analysis.

Data at rates of up to 10 Gbps and at a spacing as close as 50 GHz are easily handled by the MN9320A.

Functional and Simple to Use

- Single button operation
- Channel table shows wavelength and optical power
- Any selected channel can be dropped
- Filter design will prevent data corruption at 10 Gbps

Optical Channel Scan Mode

The MN9320A will scan the entire 'C' band window at the press of one button, identify the channels present at their optical power.

Optical Power Meter Mode

The MN9320A measures the optical power in each channel. From the measurement window the user can select to measure optical power anywhere in the 'C' band.

Channel Search Mode

The MN9320A enables a user to select a particular power level above which DWDM channels are expected. The unit will then only display

these channels in the Channel Grid Display. In addition to the tabular display in the channel table, the user can see them in a bar graph format.

Channel Insert Mode

Where non-standard channels are to be used to carry traffic or for co-channel cross-talk testing, the user can add these to the channel table.

Automatic Channel Grid Mode

From the set up screen the user can select to use the ITU-T 50 GHz or 100 GHz channel spacing. Where non standard spacings are used, custom grids can be created and stored in internal memory.

Optical Output Protection Mode

Any network data analyzer is an expensive test tool, yet the receiver can be easily damaged by the application of a high input power. The MN9320A offers a unique output protection mode to prevent this expensive mistake. On switch on, the unit has a preset level above which the output port will not become active. This level can be changed by the user in the set up screen.

Incredible Wavelength Accuracy

The optical components within the MN9320A are of the highest quality, providing wavelength accuracy of typically ±10 pm and repeatability of ±3 pm, so you can be sure it goes back to the same spot, time after time.

Specifications

Wavelength range	1528 to 1565 nm
Channel drop mode	Channel spacing: 50 GHz and higher Data rate: 10 Gbps
Wavelength accuracy	±20 pm guaranteed (±10 pm typical)
Wavelength repeatability	±3 pm
ORR @ 0.4 nm	> 40 dBc typical
Maximum input power	+18 dBm
Input power measurement range	-50 to +10 dBm
Power meter accuracy	±0.5 dBm for -40 to +10 dBm
Insertion loss	8 dB max
Display	Color STN 6" (159 mm) FVGA
External interfaces	RS-232
EMC	EN 61326: 1998 STD
Safety	EN 61010-1: 1993
Dimensions and mass	320 (W) x 133 (H) x 350 (D)(mm), 11 Kg
Power	100 to 240 VAC, 47 to 67 Hz. 250 VA max
Temperature range	Operation: 0° to 50°C Storage: -40° to +70°C

Ordering information

Please specify model/order number, name, and quantity when ordering.

Model/Order No.	Name
MN9320A	Mainframe 'C' band Optical Channel Drop Unit Standard accessories supplied with this unit: FC/UPC connectors, operation manual, AC power cord, protective front cover Options Optical Channel Drop Unit with: MN9320A-01 SC/UPC connectors MN9320A-02 ST/UPC connectors MN9320A-03 HMS-10/A connectors
760-218	Application parts Hard carry case, with storage for power cord, optical patch cords, operation manual and other accessories
J0617B	Replaceable connector(FC)
J0618D	Replaceable connector(ST)
J0618E	Replaceable connector(DIN)
J0618F	Replaceable connector(HMS-10/A)
J0619B	Replaceable connector(SC)

OPTICAL POWER METER ML910B

Traceable to ETL and NIST Standards

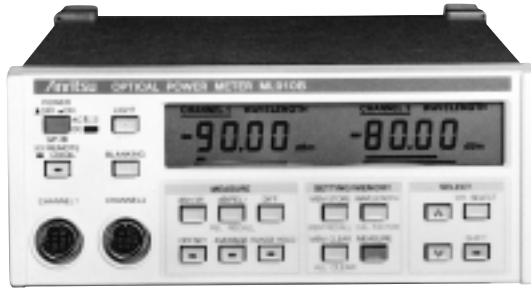

Traceable to NIST and ETL standards



The ML910B provides two independent channels and advanced functions, enabling a variety of sophisticated optical-power measurements. Seven types of optical detectors are available to suit a variety of applications — any two can be connected as required. The two channels are completely independent and have separate displays, providing the same versatility that previously required two meters. Processing between channels is also possible. If a feed-through sensor is used, fluctuations in the output level of the optical source can be canceled, enabling exceptionally precise relative measurements with a resolution down to 0.001 dB. Wavelengths from 0.38 to 1.8 μm can be measured with sensitivity down to -90 dB at 1.3 μm . The optical detectors have a built-in wavelength responsivity, so direct readout of the absolute optical power is possible simply by specifying the compensation wavelength. A simple change in connections permits uncompensated measurements as well. The data-storage function of the ML910B enables up to 3000 measured values to be stored at the touch of button, which greatly simplifies work in the field. An internal display calibration circuit is also provided, boosting overall reliability.

Features

- Two input channels with simultaneous data display
- Data processing between channels
- Relative measurements with a resolution of 0.001 dB
- Feed-through sensor permits highly stable optical-loss measurements

STANDARD OPTICAL POWER METER ML9050A

0.4 to 1.8 μm

Traceable to JQA (Japan Quality Assurance Organization)



The ML9050A can measure optical power from both beam and optical fibers with high precision and an uncertainty that is guaranteed to be within $\pm 2\%$ over the entire range of optical power levels. To maintain this high level of accuracy, the ML9050A uses a DC calibration function that compensates for variations in instrument sensitivity that result from minor variations in the ambient temperature.

The ML9050A also has an averaging function that allows the user to average 10, 100, or 1000 measurement values. Signal averaging increases the stability of low-level-signal measurement, because low-level signals tend to have relatively large fluctuations. Ni-P black body absorber, which is wavelength independent, moisture-proof, and has a vibration-free structure, is used as the optical power absorber. Amorphous Ge, which has a rapid thermo-electric response time, has been used as the thermo-electric transducer material.

Features

- Uncertainty is guaranteed to be within $\pm 2\%$.
- Wide temperature and humidity range
- 2 second response and short calibration time
- Traceable to Japan Quality Assurance Organization (JQA)

OPTICAL WAVELENGTH/FREQUENCY COUNTER MF9630A

0.6 to 1.6 μm /500 to 187 THz

For High-Accuracy Measurement of Optical Wavelength and Frequency



The MF9630A uses a Michelson interferometer to count the number of intensity fringes in the interference patterns of both the reference light source and the light source being measured. It then determines the wavelength and frequency of the light source being measured from the ratio of these numbers. The measurement accuracy (± 0.5 ppm at 0.633 μm) of the MF9630A is determined by comparing MF9630A wavelength measurement to an iodine-stabilized He-Ne laser recommended by the CIPM (Comité International Des Poids et Mesure) to define reference meter length. The uncertainty of the optical wavelength/frequency for the He-Ne laser source is 10^{-9} . When this is measured by the MF9630A, the error is ± 70 fm, which is small enough compared to the specified accuracy of ± 0.5 ppm (approx. 310 fm for every 0.633 μm).

For precise measurements, the optical fiber must be a single-mode fiber that is matched to the wavelength of DUT.

Features

- ± 0.5 ppm high-accuracy measurement
- 0.1 pm/12 MHz ultra-high resolution
- One-touch selection of wavelength or frequency
- Automatic setting of the number of display digits according to the characteristics of the light being measured

WAVEFORM MONITOR MP9650 series

For Monitoring Optical Waveform and Measuring Extinction Ratio of SDH, SONET and FDDI

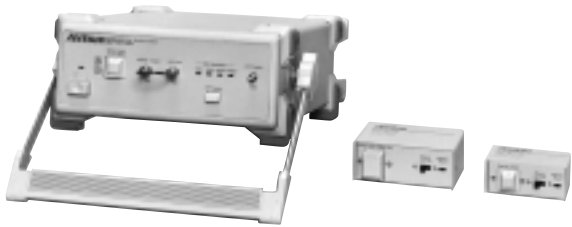

MP9654A

MP9655A

MP9653A

The MP9650 series allows an oscilloscope to monitor and measure the optical transmission waveform and its extinction ratio of an optical interface (DC to 2.5 Gbit/s). The MP9654A, with an internal DC amplifier, can be fitted with an optional 4th order Bessel-Thomson filter. It also has an optional APD setting for low-level light reception. It can be used for research, development, and maintenance applications for PCM optical interface transmitters.

Can be used on STM-0/OC-1 (51.84 Mbit/s), STM-1/OC-3 (155.52 Mbit/s), STM-4/OC-12 (622.08 Mbit/s), STM-16/OC-48 (2.48832 Gbit/s).

Features

- Optical waveform monitoring and extinction ratio measurement on SDH, SONET, FDDI
- High O/E conversion efficiency
- Optional Bessel-Thomson filter for up to a maximum of 4 frequencies
- Suitable for single-mode fibers

PROGRAMMABLE OPTICAL ATTENUATOR MN938A

0.85/1.3 μm

For Two Wavelengths of 0.85/1.3 μm



GPIB

The MN938A can set attenuation in a range of 0 to 60 dB in 0.1 dB steps. Two wavelengths can be selected. As the MN938A is provided with GPIB as standard, it can be used in a variety of automatic measuring systems for development, production, and inspection. A rotary encoder permits attenuation to be set smoothly even when used manually.

Features

- Wide attenuation range: 0 to 60 dB
- Application for two wavelengths by switch selection
- Suitable for multi-mode fibers (50/125 μm)

OPTICAL VARIABLE ATTENUATOR MN95D

1.3 μm

High-Stable Attenuation



The MN95D optical variable attenuator passes an optical signal from a light emitting element through an optical fiber via a lens through an attenuating filter to reduce it to an appropriate light power output. It is a reflection type using metallic film and is used in the 1.3 μm band. The MN95D can be varied continuously and in steps.

Features

- Metallic film filters assure a wide range of usable wavelengths and stable accuracy.
- Prevention of multiple reflection
- Small and lightweight
- Suitable for multi-mode fibers (50/125 μm)

OPTICAL ATTENUATOR MN924C, MN9605C

1.3/1.55 μm

Easy-to-Change Optical Connector Adapters



The MN924C and MN9605C are high-precision optical attenuators designed for use with single mode optical fibers. A combined step attenuator and continuous attenuator permit highly accurate attenuation adjustment.

The MN9605C has PC-type optical connectors, so that internally-reflected light is thoroughly suppressed. It is precisely constructed for single-mode fiber use and can be used as a highly accurate 65 dB variable attenuator.

Features

- Suitable for 1.3 and 1.55 μm wavelengths
- Minimal light reflection at input/output connectors (return loss: ≥ 40 dB; MN9605C)
- Optical connector adapters easily attached and removed

BARE FIBER CONNECTOR MP922B

For Low-Loss Connection of GI/SM Fibers



The MP922B is a bare-fiber connector using a V-shaped groove to temporarily and quickly connect optical fiber cores. The V-groove can be observed by microscope. This permits fine control of distance between optical fiber end-surfaces, and allows low-loss single mode fiber connection.

Features

- No special technical training required
- Low-loss connection even for single mode and multi-mode fibers
- Usable for optical fibers with jacket diameters from 0.25 to 1.2 mm

FIBER ADAPTER MA9013A

Easy-to-Use Optical Fiber Insertion



With the MA9013A Fiber Adapter, bare fiber connections can be made quickly and easily. The device, engineered to allow fiber core connections without need for polishing, is especially useful for simple temporary instrument connections during on-site operations. Moreover, the high-precision ferrule facilitates low-loss single-mode and multi-mode fiber connections.

Features

- Simple to use
- Suitable for single-mode and multi-mode fibers
- Accommodates optical fibers with external diameter error
- Compatible with various optical fibers
- Easy ferrule replacement (FC connector)

REMOTE FIBER TEST SYSTEM (RFTS) 9611A

For Remote Fiber Testing

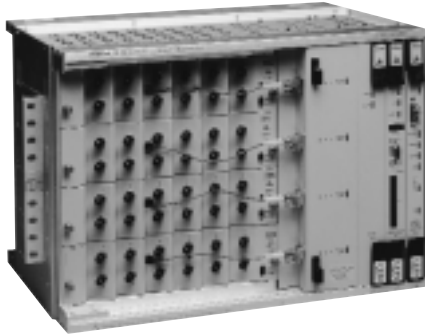

Anritsu's Remote Fiber Test System, RFTS, the complete integrated solution for testing and managing fiber networks, protects your fiber network by detecting fiber degradations before they affect service. The RFTS has an integrated access, test, fault location, and central Operations System (cOS) specifically designed for fiber networks. Trust the industry's most comprehensive, technically advanced, and cost-effective Remote Fiber Test System, the Anritsu RFTS.

RFTS was specifically designed to ensure superior network performance and maximize the profitability of your fiber investment by:

- Detecting fiber degradations before they affect service
- Meeting customer service level agreement (SLA) commitments by reducing or minimizing network downtime
- Helping recover from fiber breaks quickly
- Accurately locating fiber faults
- Geographically displaying fiber cable routes and fault location
- Performing critical measurements during network installation, troubleshooting, restoration
- Collecting and maintaining network data
- Interfacing with existing OSS, network management systems and database for full control and integration of network testing
- Efficiently utilizing manpower through centralized testing
- Maximizing fiber capacity with Active Fiber Monitoring (AFM)

OPTICAL ACCESSORIES

Anritsu offers a full line of accessories for use with optical communications measuring equipment. Please specify model/order number, name, and quantity when ordering.

	Model/Order No.	Photo No.	Name	Length	Remarks	Return loss
Optical fiber cord	J0200A	1	FC optical fiber cord (GI)	1 m	FC-FC-1M-GI	-
	J0200B			2 m	FC-FC-2M-GI	
	J0200C			3 m	FC-FC-3M-GI	
	J0056A		FC optical fiber cord (SM)	1 m	FC-FC-1M-SM	
	J0056B			2 m	FC-FC-2M-SM	
	J0056C			3 m	FC-FC-3M-SM	
	J0635A		FC · PC optical fiber cord (SM)	1 m	FC · PC-FC · PC-1M-SM	≥50 dB
	J0635B			2 m	FC · PC-FC · PC-2M-SM	
	J0635C			3 m	FC · PC-FC · PC-3M-SM	
	J0660A		SC · PC optical fiber cord (SM)	1 m	SC-PC-1M-SM	-
	J0660B			2 m	SC-PC-2M-SM	
	J0660C			3 m	SC-PC-3M-SM	
Optical conversion cord	J0520A	-	FC-SC optical conversion cord (GI)	1 m	FC-SC-1M-GI	-
	J0520B			2 m	FC-SC-2M-GI	
	J0520C			3 m	FC-SC-3M-GI	
	J0521A		FC-SC optical conversion cord (SM)	1 m	FC-SC-1M-SM	
	J0521B			2 m	FC-SC-2M-SM	
	J0521C			3 m	FC-SC-3M-SM	
	J0692A		FC · PC-SC · PC optical conversion cord (SM)	1 m	FC · PC-FC · PC-1M-SM	≥50 dB
	J0692B			2 m	FC · PC-FC · PC-2M-SM	
	J0692C			3 m	FC · PC-FC · PC-3M-SM	
	J0518A		FC-ST optical conversion cord (GI)	1 m	FC-ST-1M-GI	-
	J0518B			2 m	FC-ST-2M-GI	
	J0518C			3 m	FC-ST-3M-GI	
	J0519A		FC-ST optical conversion cord (SM)	1 m	FC-ST-1M-SM	
	J0519B			2 m	FC-ST-2M-SM	
	J0519C			3 m	FC-ST-3M-SM	
	J0757A		FC · PC-ST · PC optical conversion cord (SM)	1 m	FC · PC-ST · PC-1M-SM	≥50 dB
	J0757B			2 m	FC · PC-ST · PC-2M-SM	
	J0757C			3 m	FC · PC-ST · PC-3M-SM	
	J0516A		FC-DIN optical conversion cord (GI)	1 m	FC-DIN-1M-GI	-
	J0516B			2 m	FC-DIN-2M-GI	
	J0516C			3 m	FC-DIN-3M-GI	
	J0517A		FC-DIN optical conversion cord (SM)	1 m	FC-DIN-1M-SM	
	J0517B			2 m	FC-DIN-2M-SM	
	J0517C			3 m	FC-DIN-3M-SM	
	J0760A		FC · PC-DIN · PC optical conversion cord (SM)	1 m	FC · PC-DIN · PC-1M-SM	≥50 dB
	J0760B			2 m	FC · PC-DIN · PC-2M-SM	
	J0760C			3 m	FC · PC-DIN · PC-3M-SM	
	J0087A		FC-D4 optical conversion cord (GI)	1 m	FC-D4-1M-GI	-
	J0087B			2 m	FC-D4-2M-GI	
	J0087C			3 m	FC-D4-3M-GI	
	J0210A		FC-D4 optical conversion cord (SM)	1 m	FC-D4-1M-SM	
	J0210B			2 m	FC-D4-2M-SM	
	J0210C			3 m	FC-D4-3M-SM	
	J0637A		FC · PC-D4 · PC optical conversion cord (SM)	1 m	FC · PC-D4 · PC-1M-SM	≥27 dB
	J0637B			2 m	FC · PC-D4 · PC-2M-SM	
	J0637C			3 m	FC · PC-D4 · PC-3M-SM	

Continued on next page

	Model/Order No.	Photo No.	Name	Length	Remarks	Return loss	
Optical conversion cord	J0207A	-	FC-DIAMOND (HFS-3) optical conversion cord (GI)	1 m	FC-DIA-1M-GI	-	
	J0207B			2 m	FC-DIA-2M-GI		
	J0207C			3 m	FC-DIA-3M-GI		
	J0206A		-	FC · PC-DIAMOND (HFS-0) optical conversion cord (SM)	1 m	FC · PC-DIA · PC-1M-SM	≥50 dB
	J0206B				2 m	FC · PC-DIA · PC-2M-SM	
	J0206C				3 m	FC · PC-DIA · PC-3M-SM	
	J0686A		-	FC-HFS-13/A optical conversion cord (GI)	1 m	FC-HFS-13/A-1M-GI	-
	J0686B				2 m	FC-HFS-13/A-2M-GI	
	J0686C				3 m	FC-HFS-13/A-3M-GI	
	J0763A		-	FC · PC-HMS-10/A optical conversion cord (SM)	1 m	FC · PC-HMS-10/A · PC-1M-SM	≥50 dB
	J0763B				2 m	FC · PC-HMS-10/A · PC-2M-SM	
	J0763C				3 m	FC · PC-HMS-10/A · PC-3M-SM	
	Optical adapter		J0057	-	Optical adapter FC type	-	-
Replaceable optical connector	J0617B	6	FC connector	-	-	-	
	J0618D		ST connector				
	J0618E		DIN connector				
	J0619B		SC connector				
	J0618F		HMS-10/A connector				
Replacement optical connector	J0739A	6	FC · APC connector	-	-	-	
	J0739C		SC · APC connector				
	J0739D		HRL-10 connector				
Other accessories	J0601	2	Dummy fiber for optical loss measurements	-	-	-	
	Z0052	3	Optical fiber cutter				
	MP924A	4	Fiber Jacket Stripper				
	MZ106C	5	Mode Scrambler				

Optical fiber cord



Photo 1

Dummy fiber for optical loss measurements

This is a dummy fiber used in optical loss measurements to excite the normal propagation mode of the light.

Insertion loss	Applicable connector
<8 dB	FC-P

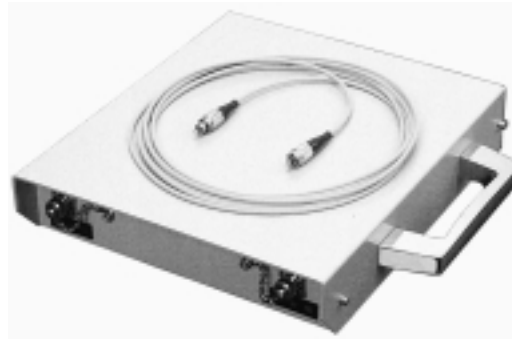

Photo 2

Optical fiber cutter

This device cuts optical fibers to produce a right-angle mirror-face break.

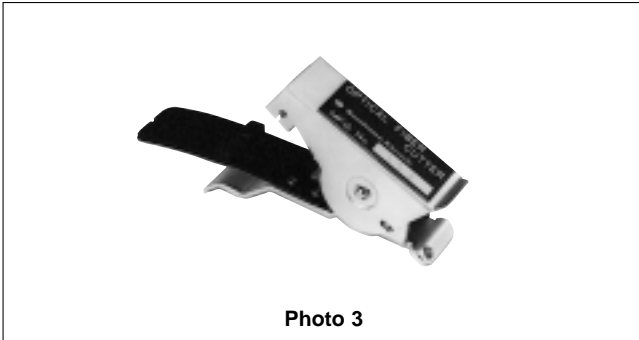

Photo 3

MP924A Fiber Jacket Stripper

This tool is used to remove the nylon jacket from around the core.



Photo 4

MZ106C Mode Scrambler

When measuring optical fiber loss or instrument insertion loss, this device is attached to LED light sources to ensure a uniform injection mode.

Insertion loss	1.5 dB*1
NA (numerical aperture)	0.195 ±0.01*2
Connector	FC
Optical fiber	GI (50/125 μm)*3
Dimensions	20 (W) x 20 (H) x 205 (D) mm

*1: Typical value (typical value is given for reference only and is not guaranteed specifications.)

Does not include connector loss.

*2: Test method depends on JIS C5961

*3: Does not include fiber

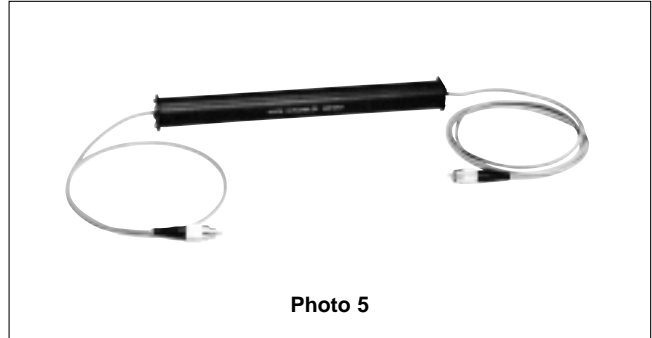

Photo 5

Replacement and replaceable optical connector

Replaceable



Replacement



Photo 6

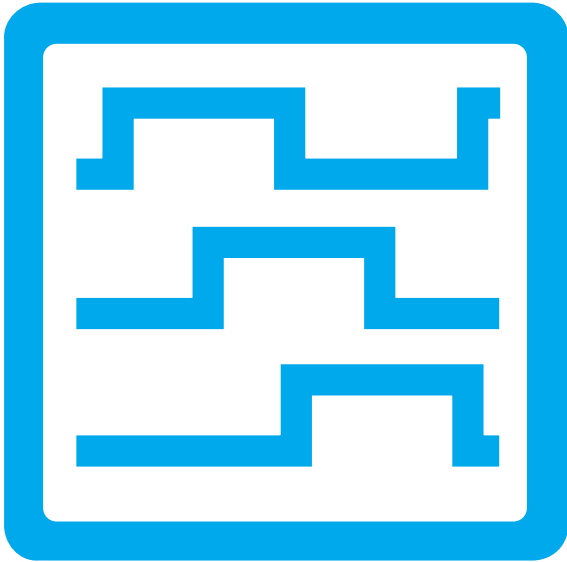

DIGITAL LINK MEASURING INSTRUMENTS

Pulse Pattern Generators	130, 133
Error Detectors	131, 136
10 GHz Jitter Analyzer	138
Digital Data Analyzers	141, 146
SONET/SDH/PDH/ATM Analyzers	150, 169
Portable 2.5G/10G Analyzer	172
Data Quality Analyzer	176
ATM Quality Analyzer	182
PCM Channel Analyzer	188
Digital Transmission Analyzer	194
STM/SONET Analyzer	194
PCM CODEC Analyzer	194

PULSE PATTERN GENERATOR

MP1758A

100 MHz to 12.5 GHz (4 channels)

For Evaluating Versatile Transmission Systems, Modules and Devices



The MP1758A has a 4-channel data output and a 2-channel clock output. It can generate two patterns: programmable and pseudo-random. The programmable pattern can be up to 128 K bit long for each channel. In addition, seven pseudo-random patterns with periods from $2^7 - 1$ to $2^{31} - 1$ can be generated with a 1/4 phase difference for each channel.

The amplitude and offset voltage of the data/clock output can be set independently for each channel. The setting ranges are 0.5 to 2.0 Vp-p for amplitude, -2.0 to +2.0 V_{OH} for offset voltage, and -500 to +500 ps for delay between the data and clock outputs.

Features

- Four independently adjustable output channels
- PRBS pattern with max. $2^{31} - 1$ bits
- Built-in synthesized clock signal

Specifications

Operation frequency	0.1 to 12.5 GHz (internal or external clock)
External clock	Input level: 0.8 to 2.0 Vp-p Input waveform: sine wave (≥ 500 MHz) or square wave Connector: APC-3.5
Internal clock	Frequency setting resolution: 1 kHz, 1 MHz Reference signal: 10 MHz (internal/external, selectable)
Pattern	Pseudo-random pattern: $2^n - 1$ (n = 7, 9, 11, 15, 20, 23, 31) Programmable pattern: max. 128 Kbit x 4 channels Logic inversion: provided Error addition (error rate): 10^{-n} (n = 4, 5, 6, 7, 8, 9), single
Data output	Output waveform: NRZ Number of outputs: 4 (CH 1, CH 2, CH 3, CH 4) Amplitude: 0.5 to 2.0 Vp-p (10 mV steps)*1 Offset voltage: -2.0 to +2.0 V _{OH} (5 mV steps)*1 ECL termination: provided Load impedance: 50 Ω Connector: APC-3.5
Clock output	Number of outputs: 2 (CLOCK 1, CLOCK 2) Amplitude: 0.5 to 2.0 Vp-p (10 mV steps)*1 Offset voltage: -2.0 to +2.0 V _{OH} (5 mV steps)*1 Delay: -500 to +500 ps (1 ps steps) ECL termination: provided Load impedance: 50 Ω Connector: APC-3.5

Sync. output	Number of outputs: 1 (1/32 CLOCK OUTPUT/PATTERN SYNC. OUTPUT, selectable) Amplitude: 0/-1 V Load impedance: 50 Ω Connector: SMA
Control	Control interface: GPIB, parallel Parameter memory: 3.5-inch FD (MS-DOS*2 compatible)
Dimensions and mass	426 (W) x 221 (H) x 450 (D) mm, ≤ 37 kg
Operating temperature	15° to 35°C
EMC	EN61326: 1997/A1: 1998 (Class A), EN61000-3-2: 1995/A2: 1998 (Class A), EN61326: 1997/A1: 1998 (Annex A)
LVD	EN610101-1: 1993/A2, 1995 (Installation Category II, Pollution degree 2)

*1: Each channel independently

*2: MS-DOS is a registered trademark of Microsoft Corporation.

Ordering information

Please specify model/order number, name, and quantity when ordering.

Model/Order No.	Name
MP1758A	Main frame Pulse Pattern Generator
F0079	Standard accessories Fuse, 10 A: 2 pcs Power cord, 2.5 m: 1 pc GPIB cable, 2 m: 1 pc Conversion connector (APC3.5-J · APC3.5-J): 7 pcs Measurement coaxial cable (SMA-P · SMA-P), 0.5 m: 6 pcs Measurement coaxial cable (SMA-P · SMA-P), 0.8 m: 1 pc Measurement coaxial cable (HRM202B-3D2W-HRM202B), 1.0 m (for sync. output): 1 pc 3.5-inch floppy disk (2HD): 2 pcs MP1758A operation manual: 1 copy MP1758A GPIB operation manual: 1 copy Wrist strap: 1 pc
Z0168 W0926AE W0927AE Z0306A	Options CLOCK/CLOCK output (factory option) Cross point adjustment (factory option)
J0500A MB24B	Optional accessories Semi-rigid cable (SMA-P · SMA-P), 0.5 m Portable Test Rack (rating current of power cord and plug: 20 A)
J0007	GPIB cable, 1 m

ERROR DETECTOR
MP1776A
 100 MHz to 12.5 GHz

Supports Measurement for up to 50 Gbit/s System (Installed with 4 Channels)



MP1776A is an error detector housing four error detectors that can measure error up to 12.5 Gbit/s. It has four-channels independent measurement mode, two-channels or four-channels combined measurement mode and be used for development, manufacturing and maintenance of transmission systems and modules from 12.5 Gbit/s to maximum 50 Gbit/s.

Features

- Max. 4-channels in one box
- Independent measurement of 4-channels
- PRBS patterns from $2^7 - 1$ to $2^{31} - 1$
- Max. 32 Mbit programmable pattern at 4-channels combined mode (corresponding six frames of STM-256/ STS-768)
- Burst data BER measurement for optical circulating loop test
- Good operability by GUI
- Display 4-channels measurement results on screen

Specifications

• **MP1776A (main frame), MU177601B (12.5 Gbit/s Error Detector)**

Operating frequency	100 MHz to 12.5 GHz
Measurement pattern	PRBS pattern: $2^n - 1$ (n: 7, 9, 11, 15, 20, 23, 31) Zero substitution pattern: 2^n (n: 7, 9, 11, 15), consecutive zero-pattern can be inserted up to pattern length - 1 Programmable data Independent: 2 to 8,388,608 bits 2-channels combined: 4 to 16,777,216 bits 4-channels combined: 8 to 33,554,432 bits Logic inversion: Positive/negative switching possible
Measurement mode	Independent*1, 2-channels combined*2, 4-channels combined*3
Synchronization method	Normal, frame
Error detection mode	Insertion, omission, total
Measurement items	Error ratio: 0.0000×10^{-16} to 1.0000×10^0 Error count: 0 to 9,999,999, 1.0000×10^7 to 9.9999×10^{16} Clock frequency: 0.1 to 12.5 GHz (independent), 0.2 to 25 GHz (2-channels combined), 0.4 to 50 GHz (4-channels combined) *Resolution: 1 kHz, accuracy: 10 ppm \pm 1 kHz
Sync threshold value	Internal, 10^{-n} (n: 2, 3, 4, 5, 6, 7, 8)
Auto search function	Supported
Data input	Input waveform: NRZ Input amplitude: 0.5 to 2.0 Vp-p Threshold voltage: -3.000 to +1.750 V (1 mV step) Termination condition: GND/-2.0 V Input impedance: 50 Ω Connector: APC-3.5 Number of input: 1 (MU177601B 12.5 Gbit/s Error Detector Unit)
Clock input	Input level: 0.5 to 2.0 Vp-p Input waveform: Square wave only (<0.5 GHz, Duty: 50%), Sine or square wave (\geq 0.5 GHz, duty: 50%) Clock delay: \pm 500 ps (1 ps step) Polarity inversion: POS/NEG inversion selectable Input impedance: 50 Ω Connector: APC-3.5 Number of input: 1 (MU177601B 12.5 Gbit/s Error Detector Unit, up to 4 channel can be added.)

Continued on next page

Resync input	Input level: 0/-1 V ±0.1 V, Connector: SMA
System environment	Display: 10.4-inch, color LCD, touch screen, 640 x 480 dots, 256 colors (16 M colors in VGA when external display is connected.) Printer: Parallel port for external printer (D-sub 25-pin) Keyboard: 101-type (English), PS/2 (mini DIN 6-pin) Mouse: Serial, PS/2 (mini DIN 6pin) FDD: 3.5-inch, 2 models (740 KB, 1.44 MB) HDD C drive: ≥474 MB (Used for system: measurement data, pattern) D drive: ≥30 MB (Not accessible to users, interface: IDE)
Remote control	RS-232C (standard, D-sub 9-pin), GPIB (IEEE488.2)
Power	90 to 120 Vac/180 to 250 Vac, 47.5 to 63 Hz, ≤1000 VA
Operating temperature	+15° to +35 °C
Dimensions and mass	426 (W) x 266 (H) x 584 (D) mm, ≤50 kg (with 4 units of MU177601B)
EMC	EN61326: 1997/A1, 1998 (Class A) EN61000-3-2: 1995/A2, 1998 (Class A) EN61326: 1997/A1, 1998 (Annex A)
LVD	EN610101-1: 1993/A2, 1995 (Installation Category II, Pollution degree 2)

- *1: Different measurement pattern and frequency can be set for each channel.
- *2: Evaluates 1:2 DEMUX to check that the signal before demultiplexing is PRBS.
- *3: Evaluates 1:4 DEMUX to check that the signal before demultiplexing is PRBS.

Ordering information

Please specify model/order number, name, and quantity when ordering.

Model/order No.	Name
MP1776A	Main frame Error Detector
	Standard accessories
J0491	Power cord (with shield, 13 A): 1 pc
J0670A	Power cord (L-type, C7, for 200 V main), 2.5 m: 1 pc
F0074	Fuse, 10 A: 1 pc
Z0319A	PS/2 mouse: 1 pc
Z0320	Input pen: 1 pc
W1410AE	MP1776A operation manual: 1 copy
W1411AE	MP1776A remote operation manual: 1 copy
Z0306A	List strap: 1 pc
Z0352	MP1776A recovery tool: 2 pcs
Z0396A	Pen holder: 1 pc
MU177601B	Unit 12.5 Gb/s Error Detector Unit
	Standard accessories
J0696B	Coaxial cable (SMA-P · SMA-P), 0.5 m: 2 pcs
J0693A	Coaxial cable (HRM202B · 3D2W · HRM202B), 1 m: 1 pc
	Optional accessories
Z0321A	Keyboard (PS/2)
J0008	GPIB cable, 2 m
B0496	Portable test rack
B0374G	Carrying case
B0497A	Dummy unit (for Slot 5)
B0497B	Dummy unit (for Slot 1 to Slot 4)
Z0416	Head cleaning disk (for 3.5-inch FDD)

PULSE PATTERN GENERATOR
MP1763C
 12.5 GHz

2

For R&D of High-Speed Logic, ICs, Optical Modules and Devices



The MP1763C is used in combination with the MP1764C Error Detector. The amplitude of the clock and data signals can be varied from 0.25 to 2 Vp-p while the offset can be adjusted to within ± 2 V so that the amplitude and the offset margin can be measured. The clock has a variable delay function so that time-dependent characteristics or phase margins of the input clock and data can be measured. An M series pseudorandom pattern representative of actual conditions or a programmable pattern can be selected as cell data. In addition, a 3.5 inch floppy disk drive is built in for storing preset data, enabling rapid measurements to be performed by simply pressing a key. A GPIB function is provided, enabling automatic or remote measurement via an external controller. The MP1763C is a pulse pattern generator ideal for research and development of high-speed logic, ICs, and digital systems.

MX176400A Q and Eye Analysis Software controls MP1763C and MP1764C from the PC to measure Q factor, eye margin, and eye diagram. MX176401A SDH/SONET Pattern Editor controls the MP1763C and MP1764C to generate frame pattern conforming to SDH/SONET standards.

Features

- High quality waveform
- Low FM/PM-noise clock generator
- 8 Mbit programmable pattern corresponding to six frames of STM-64/STS-192
- Generates PRBS patterns with bit length from $2^7 - 1$ to $2^{31} - 1$ bits
- Complementary outputs of both data and clock
- The amplitudes and offsets of all 8 data outputs that have 1/8 speed of fundamental clock signal can be set

Specifications

• **MP1763C (main frame)**

Operation frequency		0.05 to 12.5 GHz
Internal clock (option 01)	Frequency range	0.05 to 12.5 GHz
	SSB phase noise (at 10 kHz offset, 1 Hz bandwidth)	≤ -85 dBc/Hz (0.05 to 4 GHz), ≤ -80 dBc/Hz (4 to 8 GHz), ≤ -75 dBc/Hz (8 to 10 GHz), ≤ -70 dBc/Hz (10 to 12.5 GHz)
External clock input level		0.4 to 2.5 Vp-p
Pattern	Pseudorandom binary sequence pattern (PRBS)	Pattern: $2^n - 1$ (n: 7, 9, 11, 15, 20, 23, 31) Mark ratio: 1/2, 1/4, 1/8, 0/8 ($\sqrt{1/2}$), 3/4, 7/8, 8/8 are possible with logic inversion) Bit shifts number for mark ratio varied: 1, 3 bits selectable
	Data pattern	Data length: 2 to 8388608 bits
	Alternate pattern	A/B pattern data length: 128 to 4194304 bits (128 bit steps); Loop time: A, B pattern (1 to 127, 1 steps)
	Zero substitution pattern	Zero bit length: 1 to (pattern length - 1) bits; Pattern: 2^n (n: 7, 9, 11, 15)
Error addition		Error rate: 10^{-n} (n: 4, 5, 6, 7, 8, 9), and single error External error injection: Provided

Continued on next page

Data output	Number of outputs	2 (DATA/DATA independently)
	Amplitude	0.25 to 2 V _{p-p} , 2 mV steps
	Offset voltage	V _{OH} : -2 to +2 V, 1 mV steps Display: V _{OH} , V _{TH} or V _{OL} selectable
	Rise/fall time	Typical 30 ps (10% to 90% of amplitude)
	Pattern jitter	≤20 psp-p, typical 10 psp-p
	Waveform distortion (0-peak)	≤15% or ≤150 mV whichever is greater
	Gating input	Provided
	Load impedance	50 Ω (with back termination)
	Connector	APC-3.5
	DATA/DATA tracking	DATĀ amplitude and offset voltage can be set to the same values as for DATA.
	Cross point adjustment function	The cross point of DATA and DATĀ outputs can be adjusted at semifixed resistor of side.
Clock output	Number of outputs	3 (CLOCK 1/CLOCK 1̄, CLOCK 2)
	Amplitude	CLOCK 1/CLOCK 1̄: 0.25 to 2 V _{p-p} (2 mV steps) CLOCK 2: 1 V _{p-p}
	Offset voltage	CLOCK 1/CLOCK 1̄: V _{OH} -2 to +2 V (1 mV steps) CLOCK 2: V _{OH} 0 V fixed
	Rise/fall time	Typical 30 ps (10% to 90% of amplitude)
	Load impedance	50 Ω (CLOCK 1/CLOCK 1̄: with back termination)
	Connector	CLOCK 1/CLOCK 1̄: APC-3.5, CLOCK 2: SMA
	Delay	±500 ps (1 ps steps)
1/8 data and clock output		Number of outputs: DATA 8, CLOCK 1 Output level: ECL Connector: SMA
1/4 data and clock output (option 03) ^{*1}	Number of outputs	DATA: 4, CLOCK: 1
	Amplitude	0.5 to 2 V _{p-p} (2 mV steps)
	Offset voltage	V _{OH} : -1.5 to +1.5 V (1 mV steps)
	Connector	SMA
Sync. signal output	Number of outputs	1 (1/64 clock, fixed position pattern, or variable position pattern selectable)
	Output level	0/-1 V
	Connector	SMA
Parameter memory		Media: 3.5 inch FD (2HD, 2DD) Format: MS-DOS (Rev. 3.1) ^{*2} Content: Pattern or other parameters
Operating temperature range		0° to +50°C
Dimensions and mass		426 (W) x 221 (H) x 450 (D) mm, ≤33 kg
Power		≤400 VA
EMC		EN61326: 1997/A1, 1998 (Class A) EN61000-3-2: 1995/A2, 1998 (Class A) EN61326: 1997/A1, 1998 (Annex A)
LVD		EN610101-1: 1993/A2, 1995 (Installation Category II, Pollution degree 2)

*1: When the Option 03 (1/4 speed output) is added, the 1/8 speed output is not available.

*2: MS-DOS is a registered trademark of Microsoft Corporation.

• MX176400A Q and Eye Analysis Software

Required system	Computer: IBM-PC/AT or full compatible, OS: Windows 95/98/NT, CPU: Pentium 166 MHz or higher, Memory: 64 MB or more, Hard disk space: 100 MB or more GPIB: National Instruments made GPIB interface (PCMCIA-GPIB or AT-GPIB/TNT series boards are recommended.) Display Resolution: 800 x 600 or more, Display colors: 256 or more *If two or more applications are running simultaneously, operation cannot be guaranteed.
Functions	Measurement frequency: 2 to 12.5 GHz (eye diagram/eye margin measurement), 1 to 12.5 GHz (Q factor measurement) Measurement patterns: PRGM, PRBS 7, 9, 11, 15, 20, 23, 31 Pattern format: Continuous/burst (To be synchronized within 1 s) Eye margin measurement Measurement resolution (threshold): 1 to 10 mV (1 mV steps), Measurement resolution (phase): 1 to 10 ps (1 ps steps), Measurement rate: E-2 to E-15 Eye diagram measurement Measurement resolution (phase): 1 to 10 ps (1 ps steps) Measurement rate: E-2 to E-15 (actual measurement), E-3 to E-12 (estimate measurement) Display rate: E-2 to E-15 (actual measurement), E-2 to E-4915 (estimate measurement) Mask test judgment rate: E-2 to E-15 Q factor measurement Measurement style: Multiple measurements at fixed phase/phase vs. Q factor measurements Bit error rate range: Upper limit at E-3 to E-5, lower limit at E-7 to E-12 Minimum error count (measurement accuracy): 1, 10, 100, 1000 Vth shift width: Automatic, fixed (1 to 10 mV/1 mV/steps)

• **MX176401A SDH/SONET Pattern Editor**

Required system	Computer: IBM-PC/AT or full compatible, CPU: Pentium 200 MHz or higher, OS: Windows 95/98/NT, Memory: 64 MB or more Display Resolution: 800 x 600 or more; Display colors: 256 or more FDD: 3.5-inch (1.44 MB), Hard disk space: 100 MB or more GPIB: National Instruments-made GPIB interface (PCMCIA-GPIB or AT-GPIB/TNT series boards are recommended.)
Functions	SDH/SONET pattern editor Mapping: STM-N (N = 1, 4c, 12c, 16c, 32c, 64c), STS-N SPE (N = 1, 3c, 12c, 48c, 192c) Pattern edit: Arbitrary editing of program patterns (PRBS pattern can be inserted in the payload.), time indication, table indication/edit Payload: Free format, ALL 0, ALL 1, PRBS 2 ⁿ - 1 (n = 7, 9, 11, 15, 20, 20z, 23, 31) *Pattern repetition up to the length of all frames Measurement condition: ALL, payload, SOH ALL, POH ALL, OH (D1-D3), OH (D4-D12), OH (1 byte) *Pattern repetition up to the length of all frames CID pattern: Available Frame repetition: Maximum 6 frames Alarm addition: Alarm addition conforming to SDH/SONET Standard; [items: OOF/LOF, MS-AIS (L-AIS), MS-RDI (L-RDI), MS-REI (L-REI), HP-AIS (P-AIS), HP-REI (P-REI), HP-RDI (P-RDI)] BIP error addition: Generates parity errors of B1, B2, and B3 B1, B2, and B3 calculation: Available Scramble: Available BIP correction: Available Bit window: Active for patterns without frame Block window: Active for patterns without frame with a pattern length of multiples of 32 OH editor: Available

Windows is a registered trademark of Microsoft Corporation of the U.S. in the United States and other countries. IBM and AT are registered trademarks of International Business Machines. Pentium is a registered trademark of Intel Corporation. PCMCIA-GPIB and AT-GPIB/TNT are registered trademarks of National Instruments.

Ordering information

Please specify model/order number, name, and quantity when ordering.

Model/Order No.	Name
MP1763C	Main frame Pulse Pattern Generator
	Standard accessories
J0500A	Semi-rigid cable (SMA-P · SX-36 · SMA-P), 0.5 m: 2 pcs
J0672D	Semi-rigid cable, 7 cm: 1 pc
J0672F	Semi-rigid cable, 10 cm: 1 pc
J0693A	SMA cable (HRM202B · 3D2W · HRM202B), 1 m: 1 pc
J0496	APC-3.5 J-J connector: 4 pcs
J0008	GPIB cable, 2 m: 1 pc
	Power cord: 1 pc
Z0168	3.5 inch floppy disk (MF2HD-3.5MF): 2 pcs
Z0306A	Wrist strap: 1 pc
F0014	Fuse, 6.3 A (T6.3A250V): 1 pc
W1848AE	MP1763C operation manual: 1 copy
W1849AE	MP1763C GPIB operation manual: 1 copy
Z0481	12.5G/3.2G BERTS application software demo: 1 pc
B0021	Protective cover (for 1MW · 5U): 1 pc
	Options
MP1763C-01	12.5 GHz synthesizer (50 MHz to 12.5 GHz)
MP1763C-03	1/4 speed output
	Application equipment
68347B	Synthesized Sweep Generator (10 MHz to 20 GHz)
	Application software
MX176400A	Q and Eye Analysis Software
MX176401A	SDH/SONET Pattern Editor
	Optional accessories
J0500B	Semi-rigid cable (SMA-P · SX-36 · SMA-P), 1 m
J0322A	Coaxial cable (11SMA · SUCOFLEX104 · 11SMA), 0.5 m
J0322B	Coaxial cable (11SMA · SUCOFLEX104 · 11SMA), 1 m
J0007	GPIB cable, 1 m
Z0054	3.5 inch floppy disk (MF2DD-3.5MF)
MB24B	Portable Test Rack (rating current of power cord and plug: 20 A)
B0413A	Carrying case
B0163	Soft carrying case
B0044	Rack mount (for 1MW · 5U panel)
Z0292A	Stacking rack (for sweep synthesizer)
Z0416	3.5 inch head cleaning disk

ERROR DETECTOR
MP1764C
12.5 GHz

For R&D of High-Speed Logic, ICS, Optical Modules and Devices



The MP1764C is used in combination with the MP1763C Pulse Pattern Generator to detect errors used to evaluate conformity with ITU-T standards. In addition, complicated searching for input thresholds or phase adjustments is simplified with the touch of a single key. These functions are ideally suited for the research and development of ultrahigh-speed logic ICs and digital communication systems. MX176400A Q and Eye Analysis Software controls MP1764C and MP1763C from the PC to measure Q factor, eye margin, and eye diagram. MX176401A SDH/SONET Pattern Editor controls the MP1764C and MP1763C to generate frame pattern conforming to SDH/SONET standards.

Features

- Auto-search function for setting optimum values of input threshold and phase setting by a “one-touch” operation
- Synchronization of 8 Mbits pattern is easily made within a short period of time (when in frame mode)
- Errors are detected in intervals as short as 0.1 sec.
- Zero wait time counter gate

Specifications

Operation frequency		0.05 to 12.5 GHz
Data input	Input waveform	NRZ
	Input amplitude	0.25 to 2.0 Vp-p
	Threshold voltage variable range	-3.000 to +1.875 Vp-p (1 mV steps)
	Phase margin	≥70 ps (typical value at 10 Gb/s, PRBS 2 ²³ - 1, and an input amplitude of 1 Vp-p)
	Input sensitivity	50 mVp-p (typical value at 10 Gb/s and PRBS 2 ²³ - 1)
	Termination	Connected to GND or -2 V via a 50 Ω termination
	Connector	APC-3.5
Clock input	Input waveform	Rectangular wave (<0.5 GHz), rectangular or sine wave (≥0.5 GHz), duty factor: 50%
	Input voltage	0.25 to 2.0 Vp-p
	Input delay variable range	±500 ps (1 ps steps)
	Polarity inversion	CLOCK/CLOCK inversion possible
	Termination	Connected to GND or -2 V via a 50 Ω termination
	Connector	APC-3.5
Auto search function		Provided
Receive pattern	Pseudorandom binary sequence pattern (PRBS)	Pattern: 2 ⁿ - 1 (n: 7, 9, 11, 15, 20, 23, 31) Mark ratio: 1/2, 1/4, 1/8, 0/8 (1/2, 3/4, 7/8, 8/8 are possible with logic inversion.) Number of AND bit shift at mark ratio setting: 1, 3 bits (selectable by using DIP switch on rear panel)
	Data pattern	Data length: 2 to 8388608 bits
	Alternate pattern	A/B pattern word length: 128 to 4194304 bits (128 bits steps), Number of loops: Controlled using external signal
	Zero substitution pattern	Zero bit length: 1 to (pattern length - 1) bits, Pattern length: 2 ⁿ (n: 7, 9, 11, 15)

Continued on next page

Synchronous mode	Normal, frame, quick	
Synchronous threshold	Preset value or 10^{-n} (n: 2, 3, 4, 5, 6, 7, 8)	
Error detection mode	Omission insertion, total (selectable with DIP switch on rear panel)	
Measurement item	Error rate	0.0000×10^{-16} to 1.0000×10^{-0}
	Number of errors	0 to 9.9999×10^{16}
	Error interval (asynchronous)	0 to 9999999 (interval: 1 ms, 10 ms, 100 ms, 1 s)
	Error free interval (EFI)	0.0000% to 100.0000%
	Clock frequency	0.05 to 12.5 GHz, (resolution: 1 kHz, accuracy: 10 ppm \pm 1 kHz)
Eye margin measurement function	Provided	
Error performance data calculation function	Provided	
Measurement CH mask	1 to 32 ch (settable independently)	
Block window	Error for any block of 32-bit segments can be measured.	
Error analysis (option 01)	Pattern (256 bits in total) before and after bit in which error occurred is stored.	
Auxiliary output	Error output (direct)	1/128 OR error, Output level: 0/-1 V, Connector: SMA
	Error output (stretched)	Pulse width: 350 ns (typical), Output level: TTL, Connector: BNC
	Alarm output (clock loss, sync. loss)	Output level: TTL Connector: BNC
	Sync. gain output	Output level: 0/-1 V; Connector: SMA
Auxiliary input	External mask input	Input level: 0/-1 V; Connector: SMA
	Resync. input	Input level: 0/-1 V; Connector: SMA
	Alternate A/B switching input	Input level: ECL; Connector: SMA
Sync. signal output	Number of outputs	1 (1/32 clock, fixed position pattern, or variable position pattern selectable)
	Output level	0/-1 V
	Connector	SMA
Parameter memory	Media: 3.5 inch FD (2HD, 2DD) Format: MS-DOS (Rev. 3.1)*1 Content: Pattern or other parameters	
Operating temperature range	0° to +50°C	
Dimensions and mass	426 (W) x 221.5 (H) x 450 (D) mm, \leq 30 kg	
Power	\leq 300 VA	
EMC	EN61326: 1997/A1, 1998 (Class A) EN61000-3-2: 1995/A2, 1998 (Class A) EN61326: 1997/A1, 1998 (Annex A)	
LVD	EN610101-1: 1993/A2, 1995 (Installation Category II, Pollution degree 2)	

*1: MS-DOS is a registered trade mark of Microsoft Corporation.

Ordering information

Please specify model/order number, name, and quantity when ordering.

Model/Order No.	Name
MP1764C	Main frame Error Detector
	Standard accessories
J0500A	Semi-rigid cable (SMA-P · SX-36 · SMA-P), 0.5 m: 2 pcs
J0693A	SMA cable (HRM202B-3D2W-HRM202B), 1 m: 3 pcs
J0496	APC-3.5 J-J connector: 2 pcs
J0008	GPIB cable, 2 m: 2 pc Power cord: 1 pc
Z0168	3.5 inch floppy disk (MF2HD-3.5MF): 2 pcs
F0014	Fuse, 6.3 A (T6.3A250V): 1 pc
W1846AE	MP1764C operation manual: 1 copy
W1847AE	MP1764C GPIB operation manual: 1 copy
B0306A	Wrist strap: 1 pc
B0021	Protective cover (for 1MW · 5U): 1 pc
B0481	12.5G/3.2G BERTS application software demo: 1 pc
	Option
MP1764C-01	Error analysis

Model/Order No.	Name
	Application software
MX176400A	Q/Eye Analysis Software
MX176401A	SDH/SONET Pattern Editor
	Optional accessories
J0500B	Semi-rigid cable (SMA-P · SX-36 · SMA-P), 1 m
J0322A	Coaxial cable (11SMA · SUCOFLEX104 · 11SMA), 0.5 m
J0322B	Coaxial cable (11SMA · SUCOFLEX104 · 11SMA), 1 m
J0007	GPIB cable, 1 m
Z0054	3.5 inch floppy disk (MF2DD-3.5MF)
MB24B	Portable Test Rack (rating current of power cord and plug: 20A)
B0413A	Carrying case
B0163	Soft carrying case
B0044	Rack mount (for 1MW · 5U panel)
Z0416	3.5 inch head cleaning disk

10 GHz JITTER ANALYZER

MP1777A

STM-16 to 64, OC-48 to 192

For Evaluating STM-64/OC-192 Jitter



The MP1777A is a measurement solution for jitter evaluation. It supports both the STM-16/32/64 and OC-48/96/192 bit rates. In addition to supporting the bit rates of 2488.32, 4976.64, and 9953.28 MHz two additional bit rates used in submarine cable systems can be added as options.

The MP1777A can evaluate jitter characteristics, including jitter tolerance, jitter transfer, and output jitter, which are parameters most commonly used to evaluate digital lines.

The MX177701A Jitter Performance Test Software (bundled with MP1777A) allows the MP1777A to be controlled remotely. When the Jitter Performance Test Software is used together with specified auxiliary measuring instruments, jitter tolerance and jitter transfer characteristics can be measured automatically.

Functions

- **Conforms to 0.172 new recommendations**

The MP1777A meets the STM-64/OC-192 measurement standards. It is compatible with bandwidths up to 80 MHz and jitter modulation amplitudes up to 3200 Ulp-p.

- **Four optional series of bit rates**

Current submarine cable systems add FEC (forward error correction) to signals to enhance quality. The MP1777A can also support two series of bit rates by adding Option 01 (2494.16, 4988.32, 9976.64 MHz), Option 02 (2666.0571, 5332.1142, 10664.2284 MHz), Option 04 (3062.2629, 6124.7259, 12249.4517 MHz) and Option 05 (3069,6138,12276 MHz).

- **Automatic jitter measurement**

The MX177701A Jitter Performance Test Software is used for automatic jitter measurement and can be used with the MP1777A to configure an automatic measurement system for jitter tolerance and jitter transfer characteristics*1.

*1: Requires MS4630B Network Analyzer, MP1763C Pulse Pattern Generator and MP1764C Error Detector for automatic measurement of jitter tolerance. Requires MS4630B Network Analyzer and MP1763C Pulse Pattern Generator for automatic measurement of jitter transfer. Also requires controller, MX177701A Jitter Performance Test Software, GPIB card, and cables.

Application examples

- **Jitter Generation**

To generate jitter, an external signal generator is required to source a modulation signal. The MX177701A Jitter Performance Test Software and a GPIB card are required for automatic measurement. It is also possible to perform manual measurements, which does not require these items.

- **Jitter measurement**

The MP1777A can measure the jitter of input signals directly without using an external BPF. When Option 10 (High Sensitive Input) is installed, it can measure the jitter of input signals with amplitudes down to 150 mVp-p. In this case, it can perform evaluation by direct device connection. The MX177701A Jitter Performance Test Software and a GPIB card are required for automatic measurement. Manual measurement is also possible and the measurement results are checked on the MP1777A screen. Furthermore, Ulp-p, UI+p, UI-p, and UIrms can also be measured.

By combining the MP9677B E/O, O/E converter, the MP1777A can measure the jitter measurement of optical interfaces.

- **Jitter tolerance measurement**

By combining the O/E and E/O converters, the MP1777A can measure the jitter tolerance of optical interfaces. The MX177701A Jitter Performance Test Software and a GPIB card are required for automatic measurement. It is also possible to perform manual measurements without these items.

- **Measuring Jitter Transfer Characteristics**

The MP1777A can evaluate jitter transfer characteristics up to 80 MHz in applications such as 10 Gbit/s clock recovery module (O/E converter) evaluation. Automatic (using MX177701A external software/GPIB) and manual measurements are possible.

By combining the MP9677B E/O, O/E converter, the MP1777A can evaluate the jitter transfer characteristics up to 80 MHz at optical interfaces.

Specifications

<p>Bit rate</p>	<p>Standard: 2488.32, 4976.64, 9953.28 Mbit/s Option 01: 2494.16, 4988.32, 9976.64 Mbit/s Option 02: 2666.0571, 5332.1143, 10664.2286 Mbit/s Option 04: 3062.3629, 6124.7259, 12249.4517 Mbit/s Option 05: 3069.6138, 12276 Mbit/s *The Option 02 and 04 cannot be mounted at the same time.</p>																																																				
<p>Jitter generation</p>	<p>Modulation frequency: 10 Hz to 80 MHz Amplitude: 0 to 3200 Ulp-p Resolution: 0.001 Ulp-p (0.5 UI range), 0.01 Ulp-p (20, 40, 80 UI range), 1 Ulp-p (800, 1600, 3200 UI range)</p> <table border="1" data-bbox="347 705 1353 846"> <thead> <tr> <th>Bit rate (bit/s)</th> <th>f0 (Hz)</th> <th>f1 (Hz)</th> <th>f2 (Hz)</th> <th>f3 (kHz)</th> <th>f4 (MHz)</th> <th>f4' (kHz)</th> <th>f5 (MHz)</th> <th>A1 (Ulp-p)</th> <th>A2' (Ulp-p)</th> <th>A2 (Ulp-p)</th> <th>A3' (Ulp-p)</th> <th>A3 (Ulp-p)</th> </tr> </thead> <tbody> <tr> <td>2488M</td> <td>10</td> <td>15</td> <td>480</td> <td>100</td> <td>2</td> <td>100</td> <td>20</td> <td>0.5</td> <td>1</td> <td>20</td> <td>25</td> <td>800</td> </tr> <tr> <td>4977M</td> <td>10</td> <td>15</td> <td>480</td> <td>100</td> <td>2</td> <td>100</td> <td>40</td> <td>0.5</td> <td>2</td> <td>40</td> <td>50</td> <td>1600</td> </tr> <tr> <td>9953M</td> <td>10</td> <td>15</td> <td>480</td> <td>100</td> <td>2</td> <td>100</td> <td>80</td> <td>0.5</td> <td>4</td> <td>80</td> <td>100</td> <td>3200</td> </tr> </tbody> </table> <p>Accuracy: ±5% ±10 Ulp-p/Fr (3200 UI range), ±5% ±8 Ulp-p/Fr (1600 UI range), ±5% ±5 Ulp-p/Fr (800 UI range), ±5% ±0.8 Ulp-p/Fr (80 UI range), ±5% ±0.6 Ulp-p/Fr (40 UI range), ±5% ±0.3 Ulp-p/Fr (20 UI range), ±5% ±0.1 Ulp-p/Fr (0.5 UI range/10G), ±5% ±0.08 Ulp-p/Fr (0.5 UI range/5G), ±5% ±0.05 Ulp-p/Fr (0.5 UI range/2.5G) Fr: 100 kHz (0.5, 20, 40, 80 UI range), 10 Hz (800, 1600, 3200 UI range) Frequency response error (Fr Hz): ±5% (10 to 20 Hz), ±2% (20 Hz to 300 kHz), ±3% (300 kHz to 1 MHz), ±5% (1 to 3 MHz), ±10% (3 to 10 MHz), ±15% (10 to 80 MHz)</p>	Bit rate (bit/s)	f0 (Hz)	f1 (Hz)	f2 (Hz)	f3 (kHz)	f4 (MHz)	f4' (kHz)	f5 (MHz)	A1 (Ulp-p)	A2' (Ulp-p)	A2 (Ulp-p)	A3' (Ulp-p)	A3 (Ulp-p)	2488M	10	15	480	100	2	100	20	0.5	1	20	25	800	4977M	10	15	480	100	2	100	40	0.5	2	40	50	1600	9953M	10	15	480	100	2	100	80	0.5	4	80	100	3200
Bit rate (bit/s)	f0 (Hz)	f1 (Hz)	f2 (Hz)	f3 (kHz)	f4 (MHz)	f4' (kHz)	f5 (MHz)	A1 (Ulp-p)	A2' (Ulp-p)	A2 (Ulp-p)	A3' (Ulp-p)	A3 (Ulp-p)																																									
2488M	10	15	480	100	2	100	20	0.5	1	20	25	800																																									
4977M	10	15	480	100	2	100	40	0.5	2	40	50	1600																																									
9953M	10	15	480	100	2	100	80	0.5	4	80	100	3200																																									
<p>Frequency offset</p>	<p>Range: ±50 ppm (0.1 ppm steps) Accuracy: ±0.1 ppm (after power-on, calibrates after 60 min. warm-up 23 ±5°C)</p>																																																				
<p>Auxiliary interface</p>	<p>External modulation input, external 10 MHz reference input, DCS input, external reference clock input</p>																																																				
<p>Jitter measurement</p>	<p>Modulation frequency: 100 Hz to 80 MHz Amplitude: 0 to 4.00 Ulp-p, 0 to 1.41 Ulrms Resolution: 0.001 Ulp-p/0.001 Ulrms (1 UI range), 0.01 Ulp-p/0.01 Ulrms (4 UI range)</p> <table border="1" data-bbox="347 1459 1010 1692"> <thead> <tr> <th>Bit rate (bit/s)</th> <th>A2 (Ulp-p)</th> <th>A3' (Ulp-p)</th> <th>A3 (Ulp-p)</th> <th>f0 (Hz)</th> <th>f3 (MHz)</th> <th>f4 (MHz)</th> </tr> </thead> <tbody> <tr> <td rowspan="2">2488M</td> <td>1 UI range</td> <td>0.5</td> <td>1</td> <td>—</td> <td>100</td> <td>10</td> </tr> <tr> <td>4 UI range</td> <td>0.5</td> <td>—</td> <td>4</td> <td>100</td> <td>2.5</td> </tr> <tr> <td rowspan="2">4977M</td> <td>1 UI range</td> <td>0.5</td> <td>1</td> <td>—</td> <td>100</td> <td>20</td> </tr> <tr> <td>4 UI range</td> <td>0.5</td> <td>—</td> <td>4</td> <td>100</td> <td>5</td> </tr> <tr> <td rowspan="2">9953M</td> <td>1 UI range</td> <td>0.5</td> <td>1</td> <td>—</td> <td>100</td> <td>40</td> </tr> <tr> <td>4 UI range</td> <td>0.5</td> <td>—</td> <td>4</td> <td>100</td> <td>10</td> </tr> </tbody> </table>	Bit rate (bit/s)	A2 (Ulp-p)	A3' (Ulp-p)	A3 (Ulp-p)	f0 (Hz)	f3 (MHz)	f4 (MHz)	2488M	1 UI range	0.5	1	—	100	10	4 UI range	0.5	—	4	100	2.5	4977M	1 UI range	0.5	1	—	100	20	4 UI range	0.5	—	4	100	5	9953M	1 UI range	0.5	1	—	100	40	4 UI range	0.5	—	4	100	10						
Bit rate (bit/s)	A2 (Ulp-p)	A3' (Ulp-p)	A3 (Ulp-p)	f0 (Hz)	f3 (MHz)	f4 (MHz)																																															
2488M	1 UI range	0.5	1	—	100	10																																															
	4 UI range	0.5	—	4	100	2.5																																															
4977M	1 UI range	0.5	1	—	100	20																																															
	4 UI range	0.5	—	4	100	5																																															
9953M	1 UI range	0.5	1	—	100	40																																															
	4 UI range	0.5	—	4	100	10																																															

Continued on next page

MHz)	Accuracy [Ulp-p]: $\pm 5\% \pm W$ Ulp-p (Fr Hz) [Ulrms]: $\pm 5\% \pm Y$ Ulrms (Fr Hz), Fr: 100 kHz Frequency response error (Fr Hz): $\pm 5\%$ (10 to 20 Hz), $\pm 2\%$ (20 Hz to 300 kHz), $\pm 3\%$ (300 kHz to 1 MHz), $\pm 5\%$ (1 to 3 MHz), $\pm 10\%$ (3 to 10 MHz), $\pm 15\%$ (10 to 80																																																			
	<table border="1"> <thead> <tr> <th rowspan="2">Bit rate (bit/s)</th> <th colspan="2">W (Ulp-p)^{*1}</th> <th colspan="2">Y (Ulirms)^{*2}</th> </tr> <tr> <th>1 UI</th> <th>4 UI</th> <th>1 UI</th> <th>4 UI</th> </tr> </thead> <tbody> <tr> <td>2488M</td> <td>0.05</td> <td>0.22</td> <td>0.008</td> <td>0.08</td> </tr> <tr> <td>4977M</td> <td>0.07</td> <td>0.24</td> <td>0.009</td> <td>0.09</td> </tr> <tr> <td>9953M</td> <td>0.09</td> <td>0.26</td> <td>0.010</td> <td>0.10</td> </tr> </tbody> </table> <p>*1: With HP1 + LP, *2: With HP + LP Filters: LP, HP1 + LP, HP1' + LP, HP2 + LP, HP + LP, HP' + LP</p> <table border="1"> <thead> <tr> <th>Bit rate (bit/s)</th> <th>HP1 (kHz)</th> <th>HP1' (kHz)</th> <th>HP2 (MHz)</th> <th>HP (kHz)</th> <th>HP' (kHz)</th> <th>LP (MHz)</th> </tr> </thead> <tbody> <tr> <td>2488M</td> <td>5</td> <td>—</td> <td>1</td> <td>12</td> <td>—</td> <td>20</td> </tr> <tr> <td>4977M</td> <td>8</td> <td>—</td> <td>2</td> <td>12</td> <td>—</td> <td>40</td> </tr> <tr> <td>9953M</td> <td>10</td> <td>20</td> <td>4</td> <td>12</td> <td>50</td> <td>80</td> </tr> </tbody> </table>	Bit rate (bit/s)	W (Ulp-p) ^{*1}		Y (Ulirms) ^{*2}		1 UI	4 UI	1 UI	4 UI	2488M	0.05	0.22	0.008	0.08	4977M	0.07	0.24	0.009	0.09	9953M	0.09	0.26	0.010	0.10	Bit rate (bit/s)	HP1 (kHz)	HP1' (kHz)	HP2 (MHz)	HP (kHz)	HP' (kHz)	LP (MHz)	2488M	5	—	1	12	—	20	4977M	8	—	2	12	—	40	9953M	10	20	4	12	50
Bit rate (bit/s)	W (Ulp-p) ^{*1}		Y (Ulirms) ^{*2}																																																	
	1 UI	4 UI	1 UI	4 UI																																																
2488M	0.05	0.22	0.008	0.08																																																
4977M	0.07	0.24	0.009	0.09																																																
9953M	0.09	0.26	0.010	0.10																																																
Bit rate (bit/s)	HP1 (kHz)	HP1' (kHz)	HP2 (MHz)	HP (kHz)	HP' (kHz)	LP (MHz)																																														
2488M	5	—	1	12	—	20																																														
4977M	8	—	2	12	—	40																																														
9953M	10	20	4	12	50	80																																														
Jitter measurement																																																				
Auxiliary interface	Demodulation output																																																			
Internal memory	Measurement conditions: 10																																																			
Others	GPIO, Buzzer, Time																																																			
Dimensions and mass	426 (W) x 221.5 (H) x 451 (D) mm, ≤ 23 kg (with options)																																																			
Power	100 to 240 Vac, 47.5 to 63 Hz, ≤ 350 VA																																																			
Temperature	10° to 40°C																																																			
EMC	EN61326: 1997/A1, 1998 (Class A) EN61000-3-2: 1995/A2, 1998 (Class A) EN61326: 1997/A1, 1998 (Annex A)																																																			
LVD	EN610101-1: 1993/A2, 1995 (Installation Category II, Pollution degree 2)																																																			

• Operation environment

Applicable instruments	Pulse Pattern Generators: MP1763C (12.5 GHz), MP1570A (SONET/SDH/PDH/ATM Analyzer) Error Detectors: MP1764C (12.5 GHz), MP1570A (SONET/SDH/PDH/ATM Analyzer) Network Analyzer: MS4630B (300 MHz, with Option 10)
Recommended controller	Personal computer: IBM-PC/AT compatible OS: Windows®95 (English) or Windows®98 (English) CPU: Pentium (75 MHz or faster) Memory size: 16 Mbyte min. HDD free space: ≥ 300 kbyte for full install GPIO interface: National Instruments AT-GPIO/TNT (PnP), AT-GPIO/TNT+, PCMCIA-GPIO, or PCMCIA-GPIO+ and Windows® driver (for Windows®95 or Windows®98) Swap file size: ≥ 40 Mbyte guaranteed Display colors: Set to 256 Number of applications running simultaneously: 1 (unable to run other applications simultaneously)

Windows®95 and Windows®98 are registered trademarks of Microsoft® Corporation.

Ordering information

Please specify model/order number, name, and quality when ordering.

Model/Order No.	Name
MP1777A	Main frame 10 GHz Jitter Analyzer
	Standard accessories
F0014	AC power cord: 1 pc
B0329D	Fuse, 6.3 A: 2 pcs
W1497AE	Front cover: 1 pc
W1498AE	MP1777A operation manual: 1 copy
J0496	MP1777A remote control operation manual: 1 copy
J0900E	APC 3.5 J-J connector: 2 pcs
J0776C	SMA cable (50 Ω), 1.5 m (AA-165-1500): 2 pcs
J0008	BNC cable (50 Ω), 1 m: 3 pcs
MX177701A	GPIO cable, 2 m: 1 pc
W1499AE	Jitter Performance Test Software ^{*1} : 1 pc MX177701A operation manual: 1 copy

Model/Order No.	Name
	Options
MP1777A-01	2494M/4988M/9977M jitter ^{*2}
MP1777A-02	2666M/5332M/10664M jitter ^{*3}
MP1777A-04	3062M/6124M/12249M jitter ^{*4}
MP1777A-05	3069M/6138M/12276M jitter ^{*5}
MP1777A-10	High sensitive input (0.15 to 1.3 Vp-p)
	Application equipment
MS4630B	Network Analyzer (10 Hz to 300 MHz, with Option 10)
MP1763C	Pulse Pattern Generator (12.5 GHz)
MP1764C	Error Detector (12.5 GHz)
MP1570A	SONET/SDH/PDH/ATM Analyzer
MP9677B	E/O, O/E Converter

*1: Please confirm the operating system.

*2: 2494.16, 4988.32, 9976.64 MHz

*3: 2666.0571, 5332.1142, 10664.2284 MHz

*4: 3062.3629, 6124.7259, 12249.4517 MHz

*5: 3069.6138, 12276 MHz

DIGITAL DATA ANALYZER MP1630B 10 kHz to 200 MHz

2

For R&D and Manufacturing of Digital Devices and Equipment

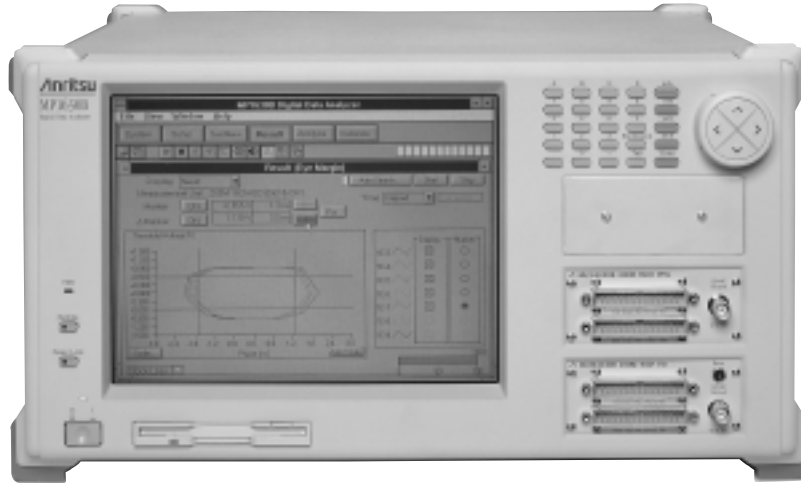

**GPIB
OPTION**

The MP1630B is a general-purpose bit error measuring instrument that can provide simultaneous measurements of multi-channel signals and burst signal measurements up to 200 MHz.

The MP1630B is not only for continuous signals – it can measure burst-signal bit error rates as well. Consequently, it is easily able to handle burst signals used by TDMA (Time Domain Multiplex Access) methods and packet/cell transmissions, etc. Both a pulse pattern generator unit and an error detector unit can be installed in the MP1630B to measure simultaneously parallel data for 16 channels using just one unit.

Features

- 16 channel PPG and ED in one cabinet
- Eye diagram measurement based on BER

Applications

- Testing multi-channel modules for optical interconnection
- E/O, O/E evaluation for optical networks (PON/PDS)
- Testing SDH/ATM equipment and modules
- Testing cable modems for digital CATV
- R&D on TDMA
- R&D on wireless LAN peripherals
- Evaluating next-generation PC interfaces (fiber channel, IEEE 1394, SSA, ATM-25)
- Evaluating digital demodulators including QPSK/QAM, etc.
- Evaluating IrDA communications equipment
- Evaluating communications LSIs, ASICs/FPGAs, and CCDs, etc.

Performance and functions

• Simultaneous bit error measurement of 16 channels

The MP1630B has 16-channel Pulse Pattern Generator and Error Detector units and can measure bit errors in parallel and simultaneously. Using the MP1630B shortens the time required to measure each device to 1/N, thereby greatly improving production efficiency.

• For both continuous and burst data

Continuous data is used in the PDH/SDH transmission system; burst data is used in the PON (Passive Optical Network) subscriber TDMA transmission system, as well as in the burst cell unit ATM-PON transmission system. The MP1630B can handle bit error measurement of both continuous and burst data. It can output burst data for up to 16 channels, and the burst cycle, guard time, preamble length, and data length can all be varied.

• Mixed pattern generation, selective BER measurement

With the MP1630B, a test pattern can be selected and set for each channel. Not only can both PRGM and PRBS patterns be used, but a mixed pattern composed of both PRGM and PRBS patterns can be generated, too. The packet type and cell type data can be configured smoothly from the overhead and payload parts. Moreover, the pattern field can split in two to 32 blocks, and a PRGM or PRBS pattern can be allocated to each column individually. As a result, it is possible to create pseudo-test signals for SDH/ATM, etc., as well as signals for evaluating complex communication protocols.

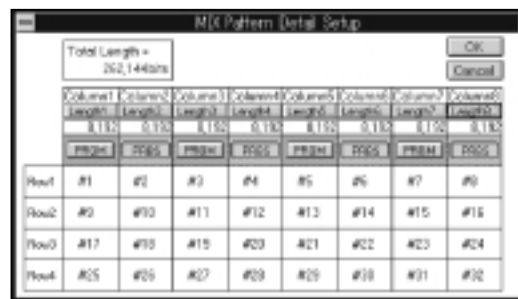

32 block mixed pattern setting screen

• Superior basic functions

A high-performance frequency synthesizer is built into the MP1630B. It generates stable, accurate signals with high resolution in the 10 kHz to 200 MHz band. In addition, when the optional digital modulator function is used, the jitter tolerance of communications equipment and devices can also be measured.

In addition to TTL, LVTTTL, ECL, and PECL, the pulse pattern generator clock and data output levels can be set to any output (0.25 to 2.5 V at 50 Ω termination; 0.5 to 5.0 V at high) for a variety of interfaces. The data and clock output delay can be varied at high resolution for each channel, and there is no need to adjust the cable length for each signal.

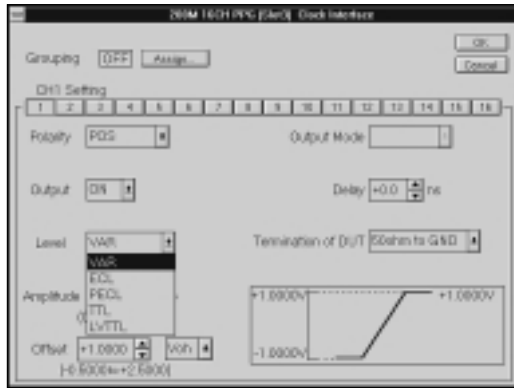

Pulse pattern generator clock interface screen

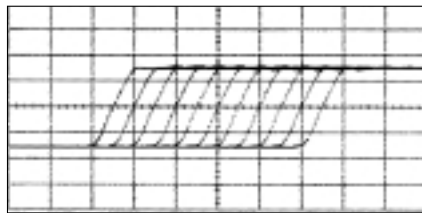

10 MHz (V: 800 mV/div, H: 2 ns/div)
Clock delay: -5 to +5 ns/1 ns steps (averaged waveform)

Variable delay characteristics

• **Evaluating error correction function using burst error insertion**

In addition to having the earlier cyclic and single error-mode insertion functions, the MP1630B has burst-mode insertion functions, making it ideal for evaluating the efficiency of error-correction codes used by each type of communication protocol. In particular, it is especially effective for testing digital transmission methods used by broadcast satellites and mobile phones, etc.

• **Evaluating data waveform quality using eye margin measurement**

The MP1630B eye margin measurement function can automatically measure the threshold voltage and phase range below the specified error rate. It has two measurement modes: the Margin mode and the Diagram mode. These modes can be selected according to the application.

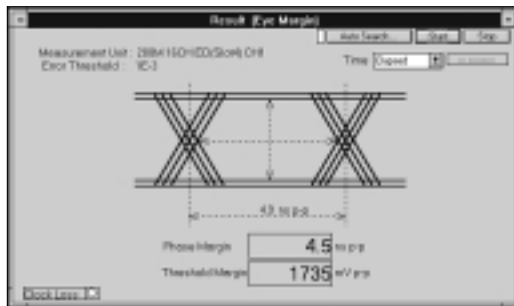

Margin mode

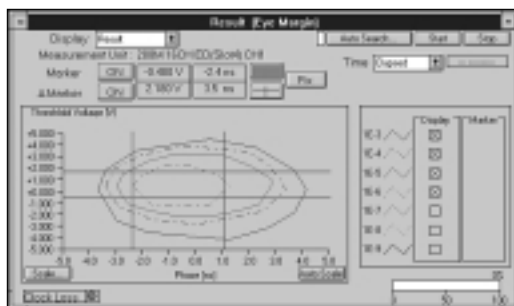
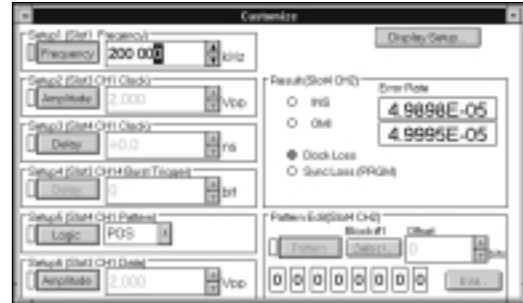

Diagram mode

• **One-key/one-parameter operation using customized screens**

Measurement of general multi-channel data requires complex operations to manage the large number of measurement parameters. To make measurement settings simpler, the MP1630B has convenient customized screens based on the one-key/one parameter operation used previously in the Anritsu BERTS. It also has a Grouping function which groups together the same measurement items used for each channel. Common settings (all or pattern-only) are saved as files on the large internal hard disk.



Customized screen

• **Powerful pattern editor function**

The MP1630B pulse pattern generator and error detector PRGM patterns can be edited easily using the keyboard, mouse, or cursor keys. There are three editing modes matching the various applications: Time, State, and Dump. The Time mode puts time on the horizontal axis and displays the pattern for each channel as a horizontal line. The State mode displays the data of channel 1 as the MSB and parallel 16 bits (corrected 1 bit from each channel at a time) as one data item. The Dump mode displays the pattern for the specified channel as a memory dump image using either binary or hexadecimal code.

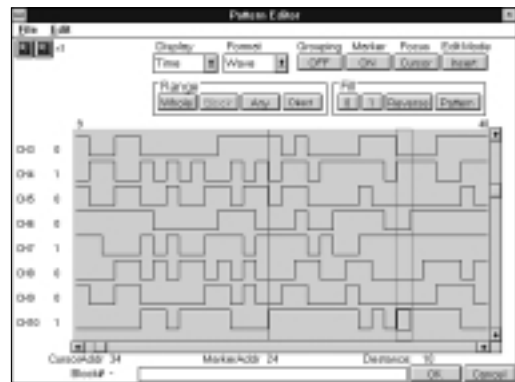

Pattern editor (time mode, input waveform)

Specifications

<p>Clock</p>	<p>Internal Operating frequency: 10 kHz to 200 MHz (accuracy: ± 2 ppm) Resolution: 1 kHz steps (>1 to 200 MHz), 100 Hz steps (10 kHz to 1 MHz) External Input frequency range: 10 kHz to 200 MHz Input level: AC, 0.5 to 2.0 Vp-p (50 Ω), BNC connector External (at locked) Input frequency range: 10 MHz ± 100 ppm, 64 kHz ± 100 ppm Input level: AC, 0.5 to 2.0 Vp-p (50 Ω), BNC connector</p>
<p>Jitter modulation function (option)</p>	<p>External modulation input Modulation frequency range: 10 Hz to 1.3 MHz Input level range (sine wave): -1 to +1 V (75 Ω), BNC connector Reference output (jitter-free output): AC, 1 Vp-p (50 Ω), SMA Jitter: 0 to 50.5 Ulp-p (clock frequency: >100 to 200 MHz) *Switchable to 50 UI/2 UI range</p> <p style="text-align: center;">Modulation frequency</p>
<p>Test pattern (pulse pattern generator, error detector)</p>	<p>PRBS Pattern: $2^n - 1$ (n: 7, 9, 11, 15, 20, 23, 31), variable mark ratio, logic selectable Zero substitution pattern: 2^n (n: 7, 9, 11, 15); pattern length: n to $2^n - 1$, logic selectable PRGM pattern: 2 to 65,536 bits/channel bit length, logic selectable Mixed pattern: Mixed PRGM and PRBS pattern, logic selectable *Block numbers: 2 to 32 [PRGM bit length/block: 8 to 8,912 bits; PRBS bit length/block: 8 to 131,072 bits (depend on block numbers)] PON pattern [TDMA test patterns with preamble inserted in ahead of Mixed patterns (PRGM and PRBS)] Preamble (1010...): 0 to 64 bits; guard time: -2,097,083 to 2,097,067 bits (1 bit resolution) Burst mode: Internal (burst cycle: 0.1 to 10 ms), external (enable length: 8 to 2,097,144 bits) Pattern edit function Edit mode: Dump, timing diagram, state table Edit results storage: Internal HDD or FDD</p>
<p>Error insertion</p>	<p>Each channel, simultaneous or independently Error type: Normal, burst Normal mode (internal: cyclic or single, external) Error rate: 10^{-n} (n: 3 to 9) Insert area: Entire area, selected blocks (in Mixed pattern or PON pattern) Burst mode (internal/external) Error rate: 10^{-n} (n: 2 to 9) Internal enable length: 20 to 140 ms (resolution: 20 ms) Internal cycle: 1 to 10 s (resolution: 1 s) External mode: Error of specified rate inserted in external signal enable period</p>
<p>Data/clock output</p>	<p>Output No.: 16 (multipin connector), output on/off and logic selectable Output waveform: NRZ (data), RZ (clock) Output level: ECL, PECL, TTL, LVTTTL, VAR VAR range Amplitude: 0.5 to 5 V (10 mV steps, high impedance), 0.25 to 2.5 V (5 mV steps, 50 Ω) Offset: -4.5 to +5 V (5 mV steps, high impedance), -2.25 to +2.5 V (2.5 mV steps, 50 Ω) Rise/fall times (typ.): 1.3 ns (1 Vp-p, 50 Ω termination) Clock delay: -5 to +5 ns (100 ps steps) Data skew: -5 to +5 ns (100 ps steps)</p>
<p>Data/clock input</p>	<p>Input No.: 16, logic selectable, multipin connector Input waveform: NRZ (data), RZ (clock) Input level: ECL, PECL, TTL, LVTTTL, VAR VAR input range Amplitude: 0.5 to 5 V (50 Ω) Threshold level: -5 to +5 V (5 mV steps, in 50 Ω to GND termination) Clock delay: -5 to +5 ns (100 ps steps)</p>
<p>Measurement data</p>	<p>Channel No.: 16 channels simultaneous measurement (selectable measurement channels) Signal format: Continuous or burst (internal/external)</p>
<p>Bit error measurement</p>	<p>Error detection: All, insertion, omission Measurement region: All, PRGM, PRBS selectable, and each block selectable with block configuration Display Error rate: 0×10^{-16} to 1.0000×10^0 Error count: 0 to 9999999, 1.0000×10^7 to 9.9999×10^{16} Error interval: 0 to 9999999, 1.0000×10^7 to 9.9999×10^{16} Error free interval: 0.0000 to 100.0000% Error performance: ITU-T Rec. G.821 Measurement mode: Single, repeat, untimed (1 second to 99 days 23 hours 59 minutes 59 seconds) Auto sync: ON/OFF switchable [threshold value: 1×10^{-n} (n: 2 to 8)], with autosearch function</p>
<p>Alarm measurement</p>	<p>Detected items: Power loss, clock loss, pattern sync loss (PRGM, PRBS)</p>

Continued on next page

Frequency measurement	Measurement range: 10 kHz to 200 MHz Effective digits: 6 digits Resolution: 100 Hz Accuracy: \pm (1 count \pm 10 ppm)
Eye margin measurement (based on BER)	Measures eye margin or eye diagram of specified data (1 channel) Eye margin: Displays threshold margin and phase margin as numeric values Eye diagram: Displays width of eye aperture as two-dimensional graph using bit-error measurement
Delay measurement	Mode: Single/repeat Unit: Time/bit numbers Range Time: 0 to 999 μ s (1 μ s steps), 1 to 999 ms (1 ms steps), 1 to 10 s (1 s steps) Bits: 2^{31} bits (max.) Time out: 0.5, 1, 2, 5, 10 s
I/O signal for burst BER measurement	Pulse pattern generator External burst input Level: TTL (H: Enable, L: Disable), BNC connector Burst trigger output (index signal for each burst data) Output No.: 16 (for each data output), bit delay function Level: ECL, -2 V (50 Ω), multipin connector Auxiliary output (PON system envelope, or AGC reset signal; usable as normal control signal) Output No.: 8 (selectable channel), 1 (OR output for each channel), bit delay function, logic selectable Level: ECL or TTL (\leq 100 Mb/s), multipin connector
	Error detector Burst trigger input Input No.: 16 (for each data input) Level: ECL, -2 V (50 Ω), multipin connector
Other I/O signals	Sync signal output (pulse pattern generator, error detector) Sync source: 1/1 clock, 1/8 clock, PRGM pattern, PRBS pattern Level: 0/-1 V (50 Ω), BNC connector External error input (pulse pattern generator) Error mode: Normal, burst Level: TTL, BNC connector Trigger output (pulse pattern generator) Trigger source: Unique pattern index for delay measurement or pattern block index in MIX/PON pattern Level: 0/-1 V (50 Ω), multipin connector Trigger input (error detector) Trigger source: For delay measurement Level: 0/-1 V (50 Ω), multipin connector
System environment	Platform: Microsoft Windows operating system version 3.1 Display: Color LCD, touch screen, 640 x 480 dots, 256 colors Printer: Parallel port for printer, D-sub 25-pin connector Keyboard: 101 keys (English), PS2 mini-DIN 6-pin connector Mouse: Serial, PS2 mini-DIN 6-pin connector FDD: 2 mode (1.44 MB, 740 KB) HDD C drive: \geq 1,380 MB (for measurement data, patterns) D drive: 30 MB (not released to user, interface: IDE)
Remote control	RS-232C (standard), GPIB (option): IEEE488.2, Ethernet (option): 10 Base-T
Other functions	Sound: When error or alarm detected, panel lock function, self check function
Power	100 to 120/200 to 240 Vac, 47.5 to 63 Hz, \leq 1,000 VA
Dimensions and mass	426 (W) x 221.5 (H) x 451 (D) mm, \leq 29 kg
Operating temperature	5° to 40°C

The specifications are with the MU163000A (200M Clock Generator Unit), MU163020B (200M 16CH Pulse Pattern Generator Unit), and MU163040B (200M 16CH Error Detector Unit) installed in the MP1630B main frame.

Ordering information

Please specify model/order number, name, and quantity when ordering.

Model/Order No.	Name
MP1630B	Main frame Digital Data Analyzer
J0491	Power cord (shielded): 1 pc
F0087	Fuse, 10 A: 2 pcs
Z0319A	PS/2 mouse: 1 pc
Z0320	Input pen: 1 pc
Z0388	MP1630B recovery disk (only for MP1630B customer): 11 pc
Z0389	MP1630B application disk (only for MP1630B customer): 7 pc
Z0390	MP1630B remote sample disk (only for MP1630B customer): 1 pc
Z0396A	Pen holder: 1 pc
W1442AE	MP1630B operation manual: 1 copy
W1443AE	MP1630B remote control operation manual: 1 copy
W1450AE	MP1630B auto adjust operation manual: 1 copy
MP1630B-01*1	Options GPIB (GPIB interface board)
MP1630B-02*1	Ethernet (Ethernet interface board)
Z0321A	Peripherals Keyboard (PS/2)
J0008	GPIB cable
MB24B	Portable Test Rack (specified current: 10 A)
B0348	Soft case
B0329D	Front cover
B0333D	Rack mount kit
MU163000A*1	Plug-in unit 200M Clock Generator Unit
W1187AE	Standard accessories MU163000A operation manual: 1 copy
MU163000A-01*1	Option Jitter addition
J0776D	Peripherals Coaxial cord (BNC-P-3W · 3D-2W · BNC-P-3W), 2 m (double shield)
MU163020B*1, *2	Plug-in unit 200M 16CH Pulse Pattern Generator Unit
J0693B	Standard accessories SMA cable, 0.27 m: 2 pcs
W1444AE	MU163020B/163040B operation manual: 1 copy
J0776D	Peripherals Coaxial cord (BNC-P-3W · 3D-2W · BNC-P-3W), 2 m (double shield)
J0824	BNC multi-core cable, (16 pins), 1 m
J0825	BNC multi-core cable, (9 pins), 1 m
J0826	SMA multi-core cable, (16 pins), 1 m
J0827	SMA multi-core cable, (9 pins), 1 m
J0858	SMA multi-core cable, (16 pins), 2 m
J0859	SMA multi-core cable, (9 pins), 2 m
J0860	BNC multi-core cable, (16 pins), 2 m
J0861	BNC multi-core cable, (9 pins), 2 m

Model/Order No.	Name
MU163040B*1, *2	Plug-in unit 200M 16CH Error Detector Unit
J0828	Standard accessories Multi-core cable, (16 pins), 0.5 m: 2 pcs
J0829	Multi-core cable, (17 pins), 0.5 m: 1 pc
J0693D	SMA cable, 0.27 m: 1 pc
W1444AE	MU163020B/163040B operation manual (not supplied when Pulse Pattern Generator Unit purchased at same time): 1 copy
J0776D	Peripherals Coaxial cord (BNC-P-3W · 3D-2W · BNC-P-3W), 2 m (double shield)
J0824	BNC multi-core cable (16 pins), 1 m
J0825	BNC multi-core cable (9 pins), 1 m
J0826	SMA multi-core cable (16 pins), 1 m
J0827	SMA multi-core cable (9 pins), 1 m
J0858	SMA multi-core cable (16 pins), 2 m
J0859	SMA multi-core cable (9 pins), 2 m
J0860	BNC multi-core cable (16 pins), 2 m
J0861	BNC multi-core cable (9 pins), 2 m

*1: Factory option

*2: Requires multi-core cable shown in peripherals (sold separately) for measurements

Microsoft is a registered trademark of Microsoft Corporation.
 Microsoft Windows is a registered trademark of Microsoft Corporation.
 Windows is an abbreviation for Microsoft Windows Operating System.
 Other product names used in this brochure are registered trademarks or products of their respective owners or manufactures.

DIGITAL DATA ANALYZER

MP1632C

50 MHz to 3.2 GHz

For Development, Manufacturing and Inspection of Transmission Systems, Optical Modules and Logic Devices



GPIB
OPTION

Core networks and computer networks are increasing rapidly as the volume of data transmitted in this multimedia data is growing. In addition to the STM-16/OC-48 (2.488 Gbit/s), Fibre channel, Giga-bit Ethernet, etc. are being commercialized. Compact and high performance digital data analyzer are required for inspecting products like digital transmission systems, optical modules, and logic devices.

The MP1632C realizes a compact solution that incorporates former measuring equipment (MP1652A Pulse Pattern Generator and MP1653A Error Detector) into a case.

MX163201A TEXT to MP1632A/C Pattern Conversion Software, MX163202A MP165X to MP1632A/C Pattern Conversion Software, MX163205A Q and Eye Analysis Software, and MX163206A SDH/SONET Pattern Editor are available as application software.

Features

- 3.2 Gb/s PPG and ED in a case
- Eye diagram measurement and burst signal measurement supported

Performance and functions

• Easy operation

The MP1632C has a large, color LCD with touch screen. Microsoft Windows® operating system version 3.1 displays measurement results graphically. Customized screens enable one-key and one-parameter operation.

• High-quality pulse pattern generator

Programmable patterns of 8 Mbit max, PRBS patterns [$(2^7 - 1)$ to $(2^{31} - 1)$ with variable mark ratio], and zero substitution patterns can be generated. Variable cross-point of data output waveform is also supported.

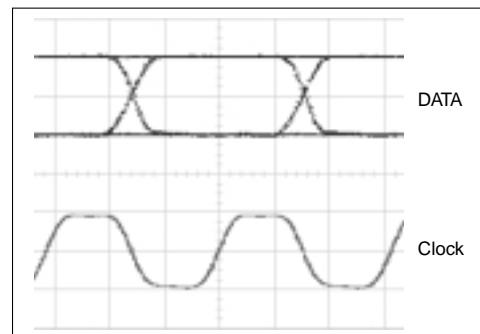

H: 100 ps/div, V: 1 V/div
MU163220C output waveform (3.2 GHz)

• Error detector with many functions

High input sensitivity (25 mVp-p^*) and wide phase margin (250 ps^*) performance is provided. The autosearch function enables PRBS pattern search with usual phase and threshold search. Insertion error and omission error can be measured simultaneously.

*Typical values at 3 Gb/s, PRBS $2^{23} - 1$

• Internal synthesizer with high signal purity (Option)

Highly pure signals, SSB phase noise characteristics of -85 dBc/Hz or less (10 kHz offset), is generated.

• Support of various applications

The MP1632C supports testing of SDH/SONET (STM-0, 1, 4, 16/OC-1, 3, 12, 48) devices and modules, research and development on WDM components, Fibre channels, Giga-bit Ethernet, evaluation of E/O and O/E module, GaAs IC, and high-speed ASIC/FPGAs

Specifications

• MU163220C 3.2G Pulse Pattern Generator

Operating frequency	10 MHz to 3.2 GHz (50 MHz to 3.2 GHz when using MP1632C-03 3.2G Internal Synthesizer)
External clock input	0.5 to 2 Vp-p (<0.5 GHz: square wave, ≥0.5 GHz: square wave or sine wave, 50% duty cycle)
Generation pattern	<p>Pseudo random pattern (PRBS) Pattern length: $2^n - 1$ (n: 7, 9, 11, 15, 20, 23, 31) Mark ratio: 1/2, 1/4, 1/8, 0/8, 1/2, 3/4, 7/8, 8/8 AND bit shift upon mark ratio setting: 1, 3 bits</p> <p>Data pattern Data length: 2 to 8,338,608 bits</p> <p>Zero substitution pattern Continuous 0 bit length: 1 to (pattern length - 1) bits Pattern length: 2^n (n: 7, 9, 11, 15)</p> <p>Error insertion Error ratio: 10^{-n} (n: 3, 4, 5, 6, 7, 8, 9), single error External error input: Provided</p>
Data output	<p>Number of outputs: 2 (DATA/DATA, independent) Amplitude: 0.5 to 2 Vp-p (10 mV steps, setting error: ±15% or ±0.1 V, whichever is greater) Offset voltage V_{OH}: -2 to +2 V (at 2 Vp-p amplitude), -3.5 to +2 V (at 0.5 Vp-p amplitude) (5 mV steps, setting error: ±15% of offset voltage, ±0.1 V or ±15% of amplitude, whichever is the greatest) Display: V_{OH}, V_{TH}, and V_{OL} selectable Rise/fall time: ≤80 ps (10% to 90% of amplitude) Pattern jitter: ≤30 psp-p Waveform distortion: 10% or 0.1 V of amplitude, whichever is greater Load impedance: 50 Ω (with back termination) Connector: SMA DATA/DATA tracking: DATA amplitude and offset voltage can be set to same value as DATA. Crosspoint adjustment function: Provided</p>
Clock output	<p>Number of output: 2 (CLOCK/CLOCK, independent) Amplitude: 0.5 to 2 Vp-p (10 mV steps, setting error: ±15% or ±0.1 V, whichever is greater) Offset voltage V_{OH}: -2 to +2 V (at 2 Vp-p amplitude), -3.5 to +2 V (at 0.5 Vp-p amplitude) (5 mV steps, setting error: ±15% of offset voltage, ±0.1 V or ±15% of amplitude, whichever is the greatest) Display: V_{OH}, V_{TH}, and V_{OL} selectable Rise/fall time: ≤80 ps (10% to 90% of amplitude) Load impedance: 50 Ω (with back termination) Connector: SMA Clock delay: -1 to +1 ns (2 ps steps)</p>
External burst trigger input	Input level: 0/-1 V, connector: SMA
Internal burst signal	Burst cycle: 2 μs to 50 ms (1 μs steps), Enable length: 1 μs to 49.999 ms (1 μs steps)
Burst trigger output	Output level: 0/-1 V, connector: SMA
Sync signal output	Number of outputs: 1 (1/8 clock, variable pattern synchronization output selectable), Output level: 0/-1 V, Connector: SMA
Operating temperature	+5 to +45°C
Power	≤200 VA
Dimensions and mass	232 (W) x 49 (H) x 449 (D) mm, ≤4.5 kg

• MU163240C 3.2G Error Detector

Operating frequency	10 MHz to 3.2 GHz (50 MHz to 3.2 GHz when using MP1632C-03 3.2G Internal Synthesizer)
Data input	<p>Input waveform: NRZ Input voltage: 0.5 to 4 Vp-p Variable threshold voltage: -4 to +4 V (1 mV steps) Termination: Connected to GND, -2 V or +3 V via 50 Ω Connector: SMA</p>
Clock input	<p>Input waveform: Square wave (<0.5 GHz), square wave or sine wave (≥0.5 GHz), duty: 50% Input amplitude: 0.5 to 4 Vp-p Variable input delay: -1 to +1 ns (2 ps steps) Polarity inversion: POS/NEG inversion selectable Termination: Connected to GND, -2 V or +3 V via 50 Ω Connector: SMA</p>
Auto search function	Phase, threshold, phase & threshold, PRBS pattern (allowed if the mark ratio is between 1/8 and 7/8)
Receive pattern	<p>Pseudo random pattern (PRBS) Pattern length: $2^n - 1$ (n: 7, 9, 11, 15, 20, 23, 31) Marker ratio: 1/2, 1/4, 1/8, 0/8, 1/2, 3/4, 7/8, 8/8 AND bit shift upon mark ratio setting: 1, 3 bits</p> <p>Data pattern Data length: 2 to 8,338,608 bits</p> <p>Zero substitution pattern Continuous 0 bit length: 1 to (pattern length - 1) bits Pattern length: 2^n (n: 7, 9, 11, 15)</p>
Sync mode	Normal, frame
Sync threshold	AUTO or 10^{-n} (n: 2, 3, 4, 5, 6, 7, 8)
Error detection mode	Omission, insertion, total

Continued on next page

Measurement items	Error rate: 0.0000 x 10 ⁻¹⁶ to 1.0000 x 10 ⁰ Number of errors: 0 to 9.9999 x 10 ¹⁶ Error interval (async): 0 to 9999999 (Interval: 100 ms, 1 s) Error free interval (EFI): 0.0000 to 100.0000% Clock frequency: 0.01 to 3.2 GHz (resolution: 1 Hz, accuracy: 10 ppm ±1 kHz)
Eye margin measurement function	Provided
Error performance calculation function	Provided
Measurement channel mask	1 to 8 channels, each channel settable independently
Error output	Number of output: 1 (1/32 bit rate OR error), Output level: 0/-1, Connector: SMA
Sync signal output	Number of outputs: 1 (switchable among 1/8 clock, fixed pattern sync, sync gain output) Output level: 0/-1 V, Connector: SMA
Burst trigger input	Input level: 0/-1 V, connector: SMA
Operating temperature	+5° to +45°C
Power	≤250 VA
Dimensions and mass	232 (W) x 54 (H) x 449 (D) mm, ≤5 kg

• MP1632C (Main frame)

System environment	OS: Microsoft Windows® operating system Version 3.1 Display: 10.4 inch, color LCD (touch screen), 640 x 480 dots, 256 colors Printer: Parallel port for external printer (D-sub, 25-pins) Keyboard: 101 type (English), PS/2 (mini DIN 6-pin connector) Mouse: Serial, PS/2 (mini DIN, 6-pin connector) FDD: 2 modes (1.44 MB, 740 KB) HDD C drive: ≥474 MB (used for system: measurement data, pattern), D drive: ≥30 MB (not accessible to users, interface: IDE)
Remote control	RS-232C (standard), GPIB (option): IEEE488.2, Ethernet (option): 10 Base-T
EMC	EN61326: 1997/A1, 1998 (Class A) EN61000-3-2: 1995/A2, 1998 (Class A) EN61326: 1997/A1, 1998 (Annex A)
LVD	EN610101-1: 1993/A2, 1995 (Installation Category II, Pollution degree 2)
Power supply	100 to 120 Vac/200 to 240 Vac, 47.5 to 63 Hz, ≤150 VA
Operating temperature	+5° to +45°C
Dimensions and mass	426 (W) x 221.5 (H) x 451(D) mm, ≤20 kg

• 3.2G internal synthesizer (Option 03)

Frequency range	50 MHz to 3.2 GHz (1 kHz steps)
Frequency accuracy	±2 ppm
SSB phase noise	≤-85 dBc/Hz (10 kHz offset, 1 kHz bandwidth)
Non-harmonic spurious	≤-60 dBc (limited to spurious 10 kHz or more distant from carrier frequency)
Reference lock range	10 MHz ±10 ppm
Power	≤50 VA
Mass	≤5 kg

• Eye diagram template (Option 20)

Required system	MP1632A
Function	Adding templates on the MP1632A's eye diagram result screen

• MX163201A TEXT to MP1632A/C Pattern Conversion Software

Required system	Computer: IBM-PC/AT or full compatible, OS: Windows 3.1/95/98, CPU: Pentium 133 MHz or higher, Memory: 32 MB or more, Hard disk space: 25 MB or more Display Resolution: 640 x 480 or more, Display colors: 256 or more FDD: 3.5-inch (1.44 MB)
Text file	A text file describing the program pattern in hex format (maximum number of characters in a line: 32696 bits including spaces and return characters)
MP1632A/C pattern data file (PTN)	All the MP1632A/C set data and patterns (file format for reading/writing on the MP1632A/C main screen)
MP1632A/C pattern clip file (PCP)	Only patterns (a file format that can be read or written in the MP1632A/C Pattern Editor)

• MX163202A MP165X to MP1632A/C Pattern Conversion Software

Required system	Computer: IBM-PC/AT or full compatible, OS: Windows 3.1/95/98, CPU: Pentium 133 MHz or higher, Memory: 32 MB or more, Hard disk space: 25 MB or more Display Resolution: 640 x 480 or more, Display colors: 256 or more FDD: 3.5-inch (1.2/1.44 MB)
Input file	MP165X program pattern files: MP165X's reading/writing and edit File name: T**.*PTN (for pulse pattern generator), R**.*PTN (for error detector)
Output file	MP1632A/C pattern data file (PTN): All the MP1632A/C set data and patterns (file format for reading/writing on the MP1632A/C main screen) MP1632A/C pattern clip file (PCP): Only patterns (File format that can be read or written in the MP1632A/C's pattern editor.)

Note: Since the FD format of MP165X is 1.2 MB, the PC must read 1.2 MB format FD.

• **MX163205A Q and Eye Analysis Software**

Required system	Computer: IBM-PC/AT or full compatible, OS: Windows 95/98/NT, CPU: Pentium 166 MHz or higher, Memory: 64 MB or more, Hard disk space: 100 MB or more, GPIB: National Instruments made GPIB interface (PCMCIA-GPIB or AT- GPIB/TNT series boards are recommended.) Display Resolution: 800 x 600 or more, Display colors: 256 or more *If two or more applications are running simultaneously, operation cannot be guaranteed.
Function	Measurement frequency: 1 to 3.2 GHz Measurement patterns: PRGM, PRBS 7, 9, 11, 15, 20, 23, 31 Pattern format: Continuous/burst (To be synchronized within 1 s) Eye margin measurement Measurement resolution (threshold): 1 to 10 mV (1 mV steps), Measurement resolution (phase): 2 to 10 ps (2 ps steps), Measurement rate: E-2 to E-15 Eye diagram measurement Measurement resolution (phase): 2 to 10 ps (2 ps steps) Measurement rate: E-2 to E-15 (actual measurement), E-3 to E-12 (estimate measurement) Display rate: E-2 to E-15 (actual measurement), E-2 to E-4915 (estimate measurement) Mask test judgment rate: E-2 to E-15 Q factor measurement Measurement style: Multiple measurements at fixed phase/phase vs. Q factor measurements Bit error rate range: Upper limit at E-3 to E-5, lower limit at E-7 to E-12 Minimum error count (measurement accuracy): 1, 10, 100, 1000 Vth shift width: Automatic, fixed (1 to 10 mV/1 mV steps)

• **MX163206A SDH/SONET Pattern Editor**

Required system	Computer: IBM-PC/AT or full compatible, CPU: Pentium 200 MHz or higher, OS: Windows 95/98/NT, Memory: 64 MB or more Display Resolution: 800 x 600 or more; Display colors: 256 or more FDD: 3.5-inch (1.44 MB), Hard disk space: 100 MB or more, GPIB: National Instruments made GPIB interface (PCMCIA-GPIB or AT-GPIB/TNT series boards are recommended.)
Functions	SDH/SONET pattern editor Mapping: STM-N (N = 1, 4c, 12c, 16c), STS-N SPE (N = 1, 3c, 12c, 48c) Pattern edit: Arbitrary editing of program patterns (PRBS pattern can be inserted in the payload.), time indication, table indication/edit Payload: Free format, ALL 0, ALL 1, PRBS 2 ⁿ - 1 (n = 7, 9, 11, 15, 20, 20z, 23, 31) *Pattern repetition up to the length of all frames CID pattern: Available Frame repetition : Maximum 26 frames Alarm addition: Alarm addition conforming to SDH/SONET Standard *items: OOF/LOF, MS-AIS (L-AIS), MS-RDI (L-RDI), MS-REI (L-REI), HP-AIS (P-AIS), HP-REI (P-REI), HP-RDI (P-RDI) BIP error addition: Generates parity errors of B1, B2, and B3 B1, B2, and B3 calculation: Available Scramble: Available BIP correction: Available OH editor: Available

Windows is a registered trademark of Microsoft Corporation of the U.S. in the United States and other countries. IBM and AT are registered trademarks of International Business Machines. Pentium is a registered trademark of Intel Corporation. PCMCIA-GPIB and AT-GPIB/TNT are registered trademarks of National Instruments.

Ordering information

Please specify model/order number, name, and quantity when ordering.

Model/Order No.	Name
MP1632C	Main frame Digital Data Analyzer
	Standard accessories
F0090	Power cord (shielded): 1 pc
Z0319A	Fuse, 8 A: 2 pcs
Z0320	PS/2 mouse: 1 pc
Z0347	Input pen: 1 pc
Z0393	Recovery disk*1: 1 set
Z0395	Application disk*1: 1 set
Z0396A	Remote sample disk*1: 1 set
W1859AE	Pen holder: 1 pc
W1860AE	MP1632C operation manual: 1 copy
B0447B	MP1632C remote control operation manual: 1 copy
	Dummy unit for EXTENSION: 1 pc
	Options
MP1632C-01	GPIB
MP1632C-02	Ethernet
MP1632C-03	3.2G internal synthesizer
	Application software
MX163201A	TEXT to MP1632A/C Pattern Conversion Software
MX163202A	MP165X to MP1632A/C Pattern Conversion Software
MX163205A	Q and Eye Analysis Software
MX163206A	SDH/SONET Pattern Editor

Model/Order No.	Name
Z0321A	Peripherals Keyboard (PS/2)
J0008	GPIB cable, 2 m
B0447A	Dummy unit for CG
B0447C	Dummy unit for PPG
B0447D	Dummy unit for ED
Z0416	3.5 inch head cleaning disk
MB24B	Portable Test Rack (specified current: 20 A)
B0348	Soft case
B0329D	Front cover
B0333D	Rack mount kit
J0905A	Semi-rigid cable (for Option 03)
Z0398	Ethernet installation disk (for Option 02)
W1529AE	Ethernet operation manual (for Option 02)
MU163220C	3.2G Pulse Pattern Generator*2
	Standard accessories
J0693A	Coaxial cord (HRM202B · 3D2W · HRM202B), 1 m: 1 pc
J0696A	Coaxial cord (AA-165-500), 0.5 m: 2 pcs
W1857AE	MU163220C/163240C operation manual: 1 copy
Z0306A	Wrist strap: 1 pc
MU163240C	3.2G Error Detector*2
	Standard accessories
J0693A	Coaxial cord (HRM202B · 3D2W · HRM202B), 1 m: 1 pc
J0696A	Coaxial cord (AA-165-500), 0.5 m: 2 pcs
W1857AE	MU163220C/163240C operation manual*3: 1 copy

*1: Only for MP1632C customer

*2: Units are factory options (not user replaceable)

*3: Not supplied when 3.2G pulse pattern generator purchased as same time

SONET/SDH/PDH/ATM ANALYZER MP1570A 1.5 Mbit/s to 10 Gbit/s

Comprehensive Testing of Core Networks from One Compact Portable Analyzer

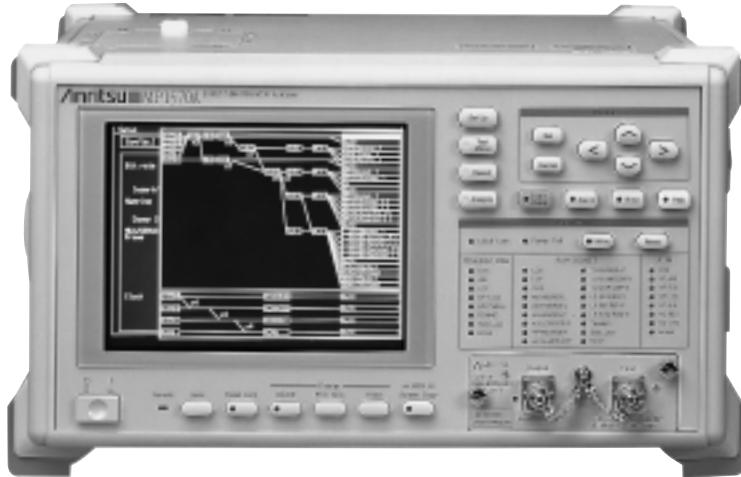

The MP1570A analyzer is designed for development, manufacturing, construction, maintenance, and inspection of SDH, SONET, PDH, and ATM equipment and networks.

A variety of plug-in units and options are available that offer the flexibility to the users to configure various analysis systems for different applications.

The MP1570A is scalable from 1.5 Mbit/s to 10 Gbit/s, and has six slots to install the plug-in units required for SDH, SONET and PDH tests at bit different rates. Installing the appropriate combinations of plug-in units can also perform ATM, jitter and wander tests conform to ITU-T O.171/O.172.

The MP1570A conforms to the ITU-T recommendations and Bellcore standards, and supports concatenation mapping, tandem connection, APS measurement, CID measurement and POS measurement. The user can measure 1.5 Mbit/s to 10 Gbit/s signals using a single MP1570A; previously, this required several measuring instruments. The MP1570A has a built-in printer and a 3.5-inch floppy disk drive as standard output devices to print measurement results, and to save and read measurement data to and from the floppy disk (FD), which can also be read on an external PC. The user can also save screen data to the FD. The MP1570A has a "HELP" key function that explains operations, functions and connections.

SDH, SONET and PDH measurement

• Measurement at bit rates from 1.5 Mbit/s to 10 Gbit/s

A mapping route to a bit rate of up to 10 Gbit/s can be set. The MP1570A mainly supports SDH, SONET, and Japanese mapping, European PDH and North American DS_n for digital communications. For concatenation mapping, a route can be set from STM-1c/STS-3c up to STM-64c/STS-192c. Furthermore, the MP1570A supports a combination of channels. For example, 64 channels of VC4c/STS3c, 16 channels of VC4-4c/STS-12c, and four channels of VC4-16c/STS-48c (See Figure 1 or Figure 2 in page 154 or 155).

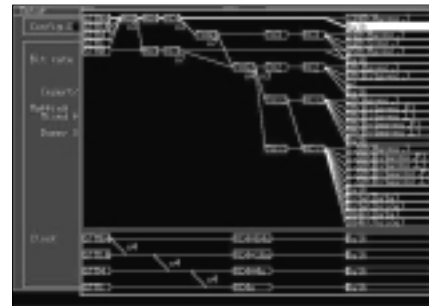

Mapping

• Overhead setting and testing

The user can modify and capture the overhead, and test the overhead portion with overhead change, pointer 64 frames, overhead add/drop and overhead bit errors.

• APS function

The user can test the automatic protection switch (APS) by measuring the equipment switching time accurately in milliseconds. The MP1570A also conforms to ITU-T Rec. G.783 and G.841.



APS test sub-screen

• Mixed payload

At mapping measurement in TUG-3 and AU3, the user can set different mapping for three additional channels other than the target measurement channel.

- **Tandem connection**

The N1/Z5 and N2/Z6 bytes can be set and measured.

- **Various analysis functions**

The internal optical power meter and frequency counter allows the user to measure optical power and frequency during error and alarm measurement without changing the connections of the signal cables. The MP1570A can capture any SOH/TOH or POH (1 byte), K1/ K2 byte, or H1/H2 byte in 1023 frames to analyze errors and alarms, and check APS operation.

Measured errors and alarms can be displayed as a graph with a time scale in 1 second, 1 minute, 15 minutes, or 60 minutes.

- **Pointer value monitoring**

Changes in pointer value can be displayed as a graph with values updated in real time.

- **MUX/DEMUX function (option)**

When the MUX/DEMUX option is added, the multiplexing structure including the frame alignment signal can be generated, and multiplexer/demultiplexer measurement can be performed.

- **Non frame pattern/CID pattern**

Frames can be set on/off at all bit rates. CID pattern can generate or analysis at SONET/SDH measurements.

- **Through modes**

One of the three through modes can be selected: (1) Transparent, (2) Overhead/Overwrite, and (3) Payload/Overwrite. The external DS1/DS3/PDH signal can be added/dropped to/from payload at payload overwrite.

- **Enhanced error/alarm simulation**

The MP1570A can generate normal and abnormal frames alternately to test the frame synchronization function of terminal equipment. (This is an SDH/SONET FAS error addition function.)

- **Easily operated pointer sequence test (combined jitter measurement)**

Able to generate the justification pattern conforming to ITU-T G.783 from the transmission equipment side, and simultaneously make the tributary signal offset variable. This makes the combined jitter test possible.

Jitter, wander measurements (1.5 Mbit/s to 2.5 Gbit/s)

The jitter/wander measurement conforming to ITU-T O.171/O.172 exceeds these standards in performance evaluation. Automatic measurements, such as jitter tolerance, jitter transfer, and jitter vs. frequency offset are performed in a short time. Various automatic measurements can be achieved with just one unit.

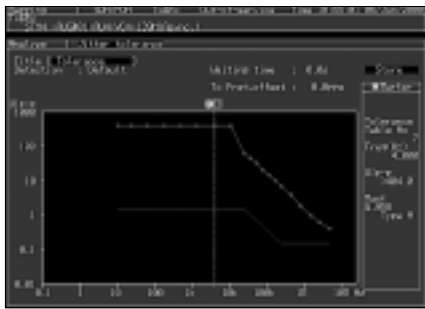

- **Various wander generation functions (option)**

Various wander generations for evaluation are available: such as TDEV wander tolerance measurement and TDEV wander transfer characteristics measurement that were regulated by ITU-T, ANSI, Bellcore, and ETSI.



- **Wander measurement (option)**

Subdivides the bandwidth of the wander measurement into three ranges, and can analyze the wander factor caused by temperature change, pointer, etc. It can also perform measurements conforming to ITU-T O.172.

- **Through jitter function (only SONET/SDH)**

Able to generate the jitter by through, while monitoring the input jitter quality.

ATM

- **Supports ATM from 1.5M to 622M rates**

TC layer mappings of 622M, 156M, 52M, 139M, 45M, 34M, 2M and 1.5M are supported along with ATM mappings of O.191, AAL1, AAL2, AAL3/4, and AAL5, which makes the MP1570A ideal for various combinations of layers. The VPI/VCI for 1023 channels can be detected automatically, and the presence/absence of alarms, cell count, and non-conforming cell count can be displayed graphically, for easy comparison of line channel traffic.

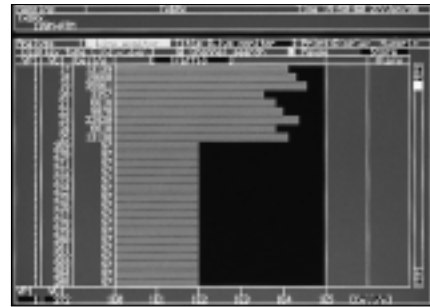

- **1- and 2-point CDV in conformance with I.356**

When measuring delay in cell traffic, either 1-point CDV or 2-point CDV conforming to ITU-T Rec. I.356 can be selected according to the conditions.

- **Simultaneous display of error cells, inserted error cells and lost cells**

The error/alarm generation conditions can be displayed both numerical and graphically to give a visual impression of the traffic conditions.

- **Traffic monitoring**

The constantly changing traffic can be displayed as a graph for the selected-one-channel VPI/VCI.

IP-over-SONET/SDH, IP-over-ATM (option)

Programs IP/PPP at will transmits it, picks PPP packet from capture memory (option), displays it and supports high-speed POS router evaluation. And programs IP in the AAL5 payload at will transmits it, picks the IP packet from the cell capture memory, and displays it. And supports ATM router evaluation.

- **IP/PPP header setting**

Able to set the value of each header optionally when selecting IPv4 or IPv6. Calculates FCS or header checksum automatically.



- **PPP packet transmission and real time count**

Transmits the three types of packets (can be set separately) by optional sequence (the idle length between each packet can be set simultaneously.). Displays the number of Tx packets and Rx ppp packets at real time.

- **PPP packet capture and display**

Samples PPP packet from the capture memory, and displays IP header. Detects FCS error and displays it in red.

Specifications

• MP0121A 2/8/34/139/156M*1 Unit

Bit rate	2.048, 8.448, 34.368, 139.264 Mbit/s
Level/waveform	Conforms to ITU-T G.703 (with 20 dB monitoring point)
Connectors	BNC (75 Ω, unbalanced), 3-pin Siemens (120 Ω, balanced) 2.048 Mbit/s: HDB3 (balanced/unbalanced) 8.448, 34.368 Mbit/s: HDB3 (unbalanced) 139.264 Mbit/s: CMI (unbalanced)
Clock	Internal (accuracy: ±7 ppm, jitter unit not installed), external (ECL [AC] 50 Ω), received signal
Frame format	Unframed: 2, 8, 34, 139 Mbit/s Framed: 2 Mbit/s (with/without CRC-4 at channels 30/31, G.704), 8 Mbit/s (G.742), 34 Mbit/s (G.751), 139 Mbit/s (G.751), MUX/DEMUX (Option 06)
Test patterns	PRBS: $2^{11} - 1$, $2^{15} - 1$, $2^{20} - 1$, $2^{23} - 1$ (O.151) Invert: On/off Word: 16-bit programmable, all 0, all 1
Error addition	Bit (all, test pattern), code, E-bit Timing: Single, rate (1E-3, 1E-4, 1E-5, 1E-6, 1E-7) FAS: n in 16 (n: 1 to 4), all
Alarm addition	LOS, LOF, AIS, RDI, RDI (MF) Timing: All
Measurements	Mode: Single, repeat, manual In-service Errors: Frame, code, CRC-4, E-bit Alarms: Power-fail, LOS, AIS, LOF, MF loss, RDI, RDI (MF) Error performance: G.821 (inc. Annex D), M.2100, G.826 Out-of-service Errors: Frame, code, CRC-4, E-bit, bit Alarms: Power-fail, LOS, AIS, LOF, MF loss, RDI, RDI (MF), sync loss Error performance: G.821 (inc. Annex D), M.2100, G.826
LEDs	LOS, AIS, LOF, MF loss, RDI, RDI (MF), sync loss, errors
Monitor	Frame word
Trouble search	Auto search for errors/alarms in all measured channels
Delay measurement	0 to 1 s
Auxiliary interface	Clock sync output, frame sync output, error output

*1: Built-in 156M CMI (electrical) interface

• MP0122A 1.5/45/52M*1 Unit, MP0122B 1.5/45/52/52M*2 (1.31) Unit

Bit rate	1.544, 44.736 Mbit/s
Level/waveform	1.544 Mbit/s: ANSI T1.102 (with 20 dB monitoring point), 0/655 ft 44.736 Mbit/s: ANSI T1.102 (with 20 dB monitoring point), 0/450/900 ft
Connectors	BNC (75 Ω, unbalanced), BANTAM (100 Ω, balanced) 1.544 Mbit/s: AMI/B8ZS (balanced), 44.736 Mbit/s: B3ZS (unbalanced)
Clock	Internal (accuracy: ±7 ppm, jitter unit not installed), external (ECL [AC] 50 Ω) received signal
Frame format	Unframed: 1.5, 45 Mbit/s Framed: 1.5 Mbit/s (D4, ESF, Japan ESF*3), 45 Mbit/s (M13, C-bit), MUX/DEMUX (Option 07)
Test patterns	PRBS: $2^{11} - 1$, $2^{15} - 1$, $2^{20} - 1$ (zero suppress), $2^{20} - 1$, $2^{23} - 1$ (O.151) Invert: On/off Word: 16-bit program, all 0, all 1, 3 in 24 (1.5 Mbit/s)
Error addition	Bit (all, test pattern), code, parity, CRC-6, C-bit, REI Timing: Single, rate (1E-3, 1E-4, 1E-5, 1E-6, 1E-7) FAS (45 Mbit/s): n in 16 (n: 1 to 4), all
X-bit setting	00, 01, 10, 11
Alarm addition	LOS, LOF, AIS, RDI Timing: All
Measurements	Mode: Single, repeat, manual In-service Errors: FAS, code, parity, CRC-6, C-bit, REI Alarms: Power-fail, LOS, AIS, LOF, RDI Error performance: G.821 (inc. Annex D), M.2100, G.826 Out-of-service Errors: FAS, code, parity, CRC-6, C-bit, REI, bit Alarms: Power-fail, LOS, AIS, LOF, RDI, sync loss Error performance: G.821 (inc. Annex D), M.2100, G.826
LEDs	LOS, LOF, AIS, RDI, sync loss, errors
Trouble search	Auto search for errors/alarms in all measured channels
Delay measurement	0 to 1 s
Auxiliary interface	Clock sync output, frame sync output, error output

*1: Built-in 52M B3ZS (electrical) interface

*2: Built-in 52M B3ZS (electrical) and optical interfaces

*3: Mounted Option 09 (Japan mapping)

• 52/156/622/2488/9953M (SDH)

Bit rate	51.84, 155.52, 622.08, 2488.32, 9953.28 Mbit/s
Level/waveform	52M (electrical: B3ZS)*1: ANSI T1.102, 0/450 ft 52M (optical): As per MP0122B unit optical interface specifications 156M (electrical: CMI)*2: ITU-T G.703 156M (optical): As per optical 156M/622M unit specifications 622M (electrical/optical): As per optical 156M/622M unit and NRZ unit specifications 2488M (electrical/optical): As per 2.5G unit and 2.5G/10G unit specifications 9953M (electrical/optical): As per 2.5G/10G unit specifications
Clock	Internal (accuracy: ± 3.5 ppm, jitter unit not installed), Lock (2 MHz, 1.5 MHz, 64 kHz + 8 kHz, 2 Mbit/s, 1.5 Mbit/s), external (ECL [AC] 50 Ω , 9953M: 1.02 to 0.58 Vp-p, 50 Ω), received signal
Frame	SDH/SONET, CID pattern, non-frame
Mapping	See Fig. 1
Through	Trance parent, over head overwrite, payload overwrite
Test patterns	PRBS: $2^{11} - 1$, $2^{15} - 1$, $2^{20} - 1$ (zero suppress, MP0122A/B installed), $2^{20} - 1$, $2^{23} - 1$, $2^{31} - 1$ (only concatenation mapping) 16c/64c, conform to O.151) Invert: On/off Word: 16-bit programmable, all 0, all 1
Error addition	Bit all (all, test pattern), FAS, B1, B2, B3, BIP-2, MS-REI, HP-REI, LP-REI Timing: Single, single (burst) bit (1 to 64000), rate (1E-3, 1E-4, 1E-5, 1E-6, 1E-7, 1E-8, 1E-9) User program AE-B [A: 1.0 to 9.9 (step: 0.1), B: 2 to 10] Alternative: Error frame (0 to 8000), normal frame (1 to 8000)
Alarm addition	LOS, LOF, MS-AIS, MS-RDI, AU-AIS, AU-LOP, HP-SLM, HP-TIM, HP-RDI, HP-UNEQ, TU-AIS, TU-LOP, TU-LOM, LP-SLM, LP-TIM, LP-RDI, LP-UNEQ, LP-RFI Timing: Single, single (burst) frame Alternative: Alarm frame (0 to 8000), normal frame (1 to 8000), all
Measurements	Mode: Single, repeat, manual In-service/Out-of-service Errors: B1, B2, B3, BIP-2, MS-REI, HP-REI, LP-REI Alarms: Power-fail, LOS, LOF, OOF, MS-AIS, MS-RDI, AU-AIS, AU-LOP, HP-SLM, HP-TIM, HP-RDI, HP-UNEQ, TU-AIS, TU-LOP, TU-LOM, LP-SLM, LP-TIM, LP-RDI, LP-UNEQ, LP-RFI Error performance: G.826, M2101, M2110, M2120 Preset: Alarm measurement condition
LEDs	LOS, LOF, OOF, MS-AIS, MS-RDI, AU-AIS, AU-LOP, HP-RDI, HP-SLM, TU-AIS, TU-LOM, TU-LOP, LP-RDI, LP-RFI, LP-SLM, Tandem, sync. loss, errors
Tandem connection	N1 byte (Type 1, Type 2), N2 byte Errors: N2 BIP-2, TC-REI, OEI, IEC Alarms: VC-AIS, ISF, FAS, HP-Incoming-AIS, HP-TC-RDI, HP-ODI, LP-Incoming-AIS, LP-TC-RDI, LP-ODI
Justification	AU pointer, TU pointer, C, C1/C2 Measurement: NDF, +PJC, -PJC, Cons, C, C1/C2
Monitor	SOH, POH, K1/K2, pointer, path trace (TIM alarms detectable), Tandem, payload
Pointer sequence	Signal of opposites polarity, regular with double, regular with missing, double of opposites polarity, 87-3/26-1 (normal, add, cancel), continuous pattern (normal, add, cancel), single pointer adjustment, maximum rate pointer burst, phase transient pointer burst, initialize period polarity, cooldown period
Over head capture	SOH/POH (any 1 byte), H1/H2, K1/K2
Dummy channel setting	Payload: Dummy, copy, mixed payload Setting: POH, pathtrace, SS bit, Tandem
Simultaneous measurement	VC2, VC12, VC11
Trouble search	Auto search for errors/alarms in all measured channels
Delay	Measurement period: 0.5, 1, 2, 5, 10 s Measurement range: 0 to 999 μ s, 1.0 to 999.9 ms, 1.0 to 10.0 s, time out Display accuracy: ± 5 μ s (0.5, 1 s), ± 50 μ s (2, 5, 10 s)
APS (K1/K2)	Switching time measurement Measurement range: 1 to 2000 ms, >2000 ms Trigger Internal: B1, B2, B3, BIP-2, MS-REI, HP-REI, LP-REI, MS-AIS, AU-AIS, AU-LOP, HP-RDI, TU-AIS, TU-LOM, TU-LOP, LP-RDI, LP-RFI, Bit External: Measures trigger input signal (active high) Threshold: Specify non-error alarm between 1 ms, 10 ms, 100 ms Sequence generation: 2 to 64 word, repeat (8000 frame) Sequence capture: 2 to 64 word, repeat (8000 frame)
Frequency measurement	Range: ± 100 ppm, Accuracy: ± 3.5 ppm (jitter unit not installed)
Over head test	OH change: SOH/POH 1 byte, K1/K2, RSOH, MSOH, SOH, POH (except B1, B2, B3, BIP-2) PTR 64 frame: AU pointer, TU pointer Timing: Single, repeat (2 to 64) Setting: PTR, NDF, +PJC, -PJC OH BERT: SOH/POH 1 byte (exclude B1, B2, B3, BIP-2), D1-D3, D4-D12 Test pattern: $2^{11} - 1$, $2^{15} - 1$ OH add/drop: SOH/POH 1 byte, D1-D3, D4-D12 (exclude B1, B2, B3, BIP-2 additional type)
Japan mapping (option 09)	VC11 Signaling (8-multiframe, 64-multiframe setting)
Frame memory/capture	Memory size: 64 frame (156M, 622M, Option 13), 64 frame (MU150008A-01/150009A-01/150010A-01, 2.5G), 26 frame (MU150000A-01, 2.5G/10G)
Insert/extract	Bit rate: 10G (52M, 156M), 2.5G (52M, 156M)
Payload offset	± 100 ppm/0.1 ppm step
Auxiliary interface	Clock sync output, trigger input, trigger output, DCC interface (V.11), orderwire, receive clock output

*1: Mounted MP0122A/B, *2: Mounted MP0121A

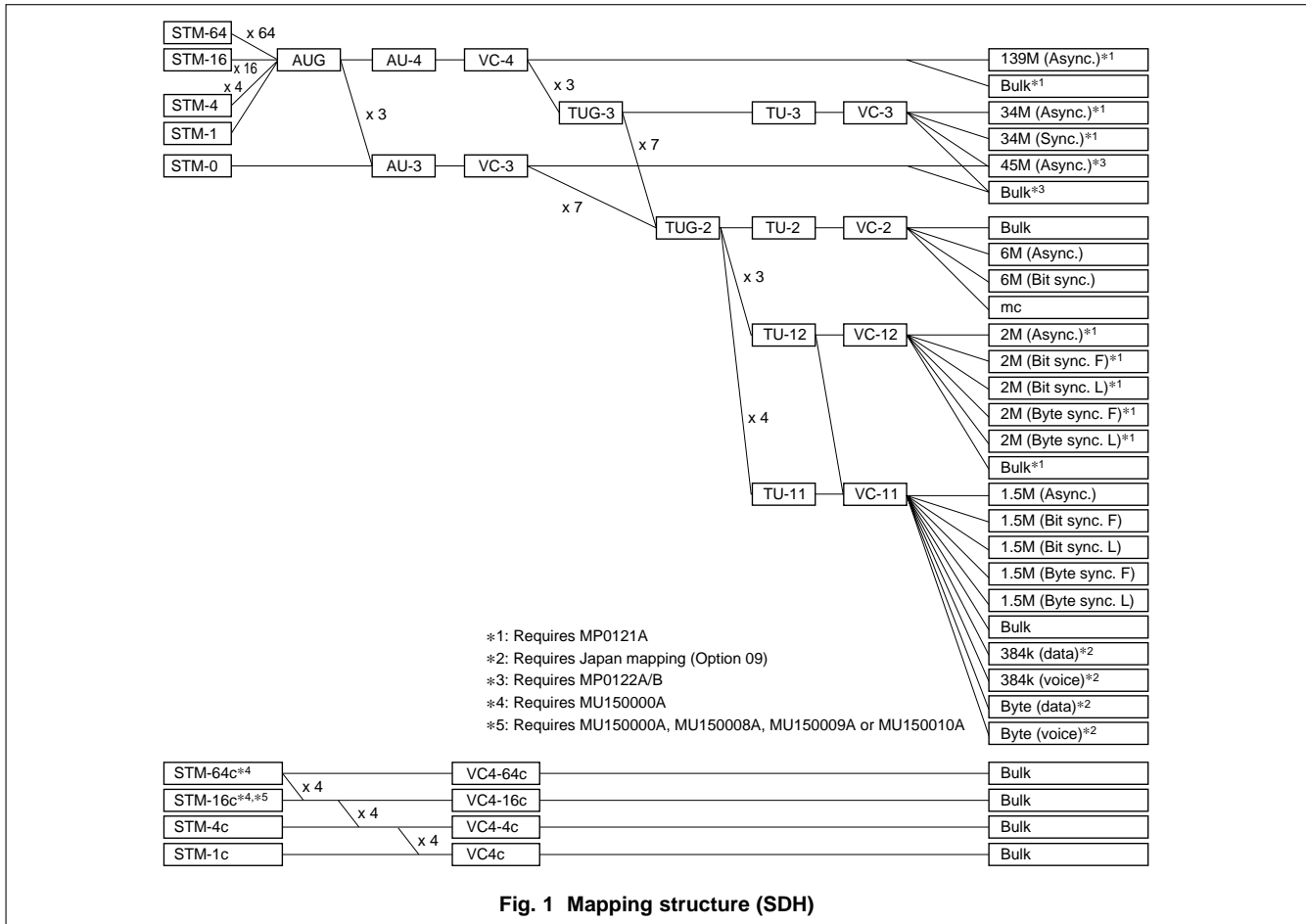

• 52/156/622/2488/9953M (SONET)

Bit rate	51.84, 155.52, 622.08, 2488.32, 9953.28 Mbit/s
Level/waveform	52M (electrical: B3ZS) ^{*1} : ANSI T1.102, 0/450 ft 52M (optical): As per MP0122B unit optical interface specifications 156M (electrical: CMI) ^{*2} : ITU-T G.703 156M (optical): As per optical 156M/622M unit specifications 622M (electrical/optical): As per optical 156M/622M unit and NRZ unit specifications 2488M (electrical/optical): As per 2.5G unit and 2.5G/10G unit specifications 9953M (electrical/optical): As per 2.5G/10G unit specifications
Clock	Internal (accuracy: ±3.5 ppm, jitter unit not installed), Lock (2 MHz, 1.5 MHz, 64 kHz + 8 kHz, 2 Mbit/s, 1.5 Mbit/s), External (ECL [AC] 50 Ω, 9953M: 1.02 to 0.58 Vp-p, 50 Ω), received signal
Frame	SDH/SONET, CID pattern, non-frame
Mapping	See Fig. 2
Through	Trance parent, over head overwrite, payload overwrite
Test patterns	PRBS: 2 ¹¹ - 1, 2 ¹⁵ - 1, 2 ²⁰ - 1 (zero suppress, MP0122A/B installed), 2 ²⁰ - 1, 2 ²³ - 1, 2 ³¹ - 1 (only concatenation mapping 16c/64c, conform to O.151) Invert: On/off Word: 16-bit programmable, all 0, all 1
Error addition	Bit all (all, test pattern), FAS, B1, B2, B3, BIP-2, REI-L, REI-P, REI-V Timing: Single, single (burst) bit (1 to 64000), rate (1E-3, 1E-4, 1E-5, 1E-6, 1E-7, 1E-8, 1E-9) User program AE-B [A: 1.0 to 9.9 (step: 0.1), B: 2 to 10] Alternative: Error frame (0 to 8000), normal frame (1 to 8000)
Alarm addition	LOS, LOF, AIS-L, RDI-L, AIS-P, LOP-P, PLM-P, HP-TIM, RDI-P, UNEQ-P, AIS-V, LOP-V, LOM-V, PLM-V, LP-TIM, RDI-V, UNEQ-V, RFI-V Timing: Single, single (burst) frame Alternative: alarm frame (0 to 8000), normal frame (1 to 8000), all
Measurements	Mode: Single, repeat, manual In-service/Out-of-service Errors: B1, B2, B3, BIP-2, REI-L, REI-P, REI-V Alarms: Power-fail, LOS, LOF, OOF, AIS-L, RDI-L, AIS-P, LOP-P, PLM-P, HP-TIM, RDI-P, UNEQ-P, AIS-V, LOP-V, LOM-V, PLM-V, LP-TIM, RDI-V, UNEQ-V, RFI-V Error performance: G.826, M2101, M2110, M2120 Preset: Alarm measurement condition
LEDs	LOS, LOF, OOF, AIS-L, RDI-L, AIS-P, LOP-P, RDI-P, PLM-P, AIS-V, LOM-V, LOP-V, RDI-V, RFI-V, PLM-V, Tandem, sync. loss, errors
Tandem connection	Z5 byte (Type 1, Type 2), Z6 byte Errors: Z6 BIP-2, TC-REI, OEI, IEC Alarms: VC-AIS, ISF, FAS, HP-Incoming-AIS, HP-TC-RDI, HP-ODI, LP-Incoming-AIS, LP-TC-RDI, LP-ODI

Continued on next page

Justification	STS pointer, VT pointer, C, C1/C2 Measurement: NDF, +PJC, -PJC, Cons, C, C1/C2
Monitor	TOH, POH, K1/K2, pointer, path trace (TIM alarms detectable), Tandem, payload
Pointer sequence	Signal of opposites polarity, regular with double, regular with missing, double of opposites polarity, 87-3/26-1 (normal, add, cancel), continuous pattern (normal, add, cancel), single pointer adjustment, maximum rate pointer burst, phase transient pointer burst, initialize period polarity, cooldown period
Over head capture	TOH/POH (any 1 byte), H1/H2, K1/K2
Dummy channel setting	Payload: Dummy, copy, mixed payload Setting: POH, pathtrace, SS bit, Tandem
Simultaneous measurement	VT6SPE, VT2SPE, VT1.5SPE
Trouble search	Auto search for errors/alarms in all measured channels
Delay	Measurement period: 0.5, 1, 2, 5, 10 s Measurement range: 0 to 999 μ s, 1.0 to 999.9 ms, 1.0 to 10.0 s, time out Display accuracy: $\pm 5 \mu$ s (0.5, 1 s), $\pm 50 \mu$ s (2, 5, 10 s)
APS (K1/K2)	Switching time measurement Measurement range: 1 to 2000 ms, >2000 ms Trigger Internal: B1, B2, B3, BIP-2, REI-L, REI-P, REI-V, AIS-L, AIS-P, LOP-P, RDI-P, AIS-V, LOM-V, LOP-V, RDI-V, RFI-V, Bit External: Measures trigger input signal (active high) Threshold: Specify non-error alarm between 1 ms, 10 ms, 100 ms Sequence generation: 2 to 64 word, repeat (8000 frame) Sequence capture: 2 to 64 word, repeat (8000 frame)
Frequency measurement	Range: ± 100 ppm, Accuracy: ± 3.5 ppm (jitter unit not installed)
Over head test	OH change: TOH/POH 1 byte, K1/K2, LOH, SOH, TOH, POH (except B1, B2, B3, BIP-2) PTR 64 frame: STS pointer, VT pointer Timing: Single, repeat (2 to 64) Setting: PTR, NDF, +PJC, -PJC OH BERT: TOH/POH 1 byte (exclude B1, B2, B3, BIP-2), D1-D3, D4-D12 Test pattern: $2^{11} - 1$, $2^{15} - 1$ OH add/drop: TOH/POH 1 byte, D1-D3, D4-D12 (exclude B1, B2, B3, BIP-2 additional type)
Japan mapping (option 09)	VT1.5SPE Signaling (8-multiframe, 64-multiframe setting)
Frame memory/capture	Memory size: 64 frame (156M, 622M, Option 13), 64 frame (MU150008A-01/150009A-01/150010A-01, 2.5G), 26 frame (MU150000A-01, 2.5G/10G)
Insert/extract	Bit rate: 10G (52M, 156M, 622M), 2.5G (52M, 156M, 622M)
Payload offset	± 100 ppm/0.1 ppm step
Auxiliary interface	Clock sync output, trigger input, trigger output, DCC interface (V.11), orderwire, receive clock output

*1: Mounted MP0122A/B, *2: Mounted MP0121A

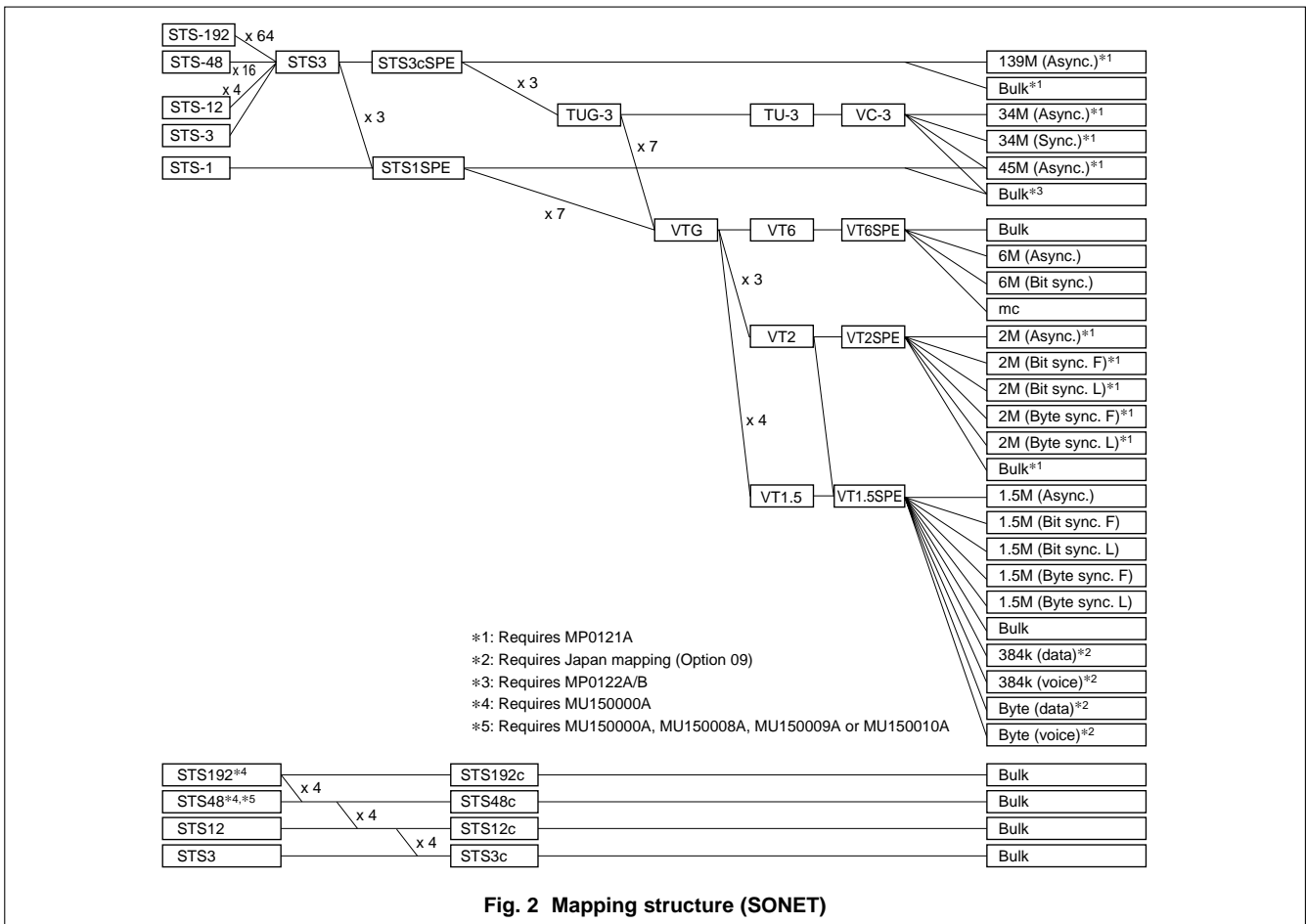

Fig. 2 Mapping structure (SONET)

• IP-over-SONET/SDH (Option)*1

Bit rate	155.52, 622.08, 2488.32, 9953.28 Mbit/s
PPP setting (RFC1662)	Flag, address, control: Any settable Protocol: 8/16 bit selectable and any settable FCS: 16/32 bit selectable and auto calculate Information: IPv4/IPv6 selectable and any settable
IPv4 setting (RFC0791)	Any setting: Version, IHL, TOS, total length, ID, flags, fragment offset, TTL, protocol, address (source, destination) Header checksum: Auto calculate Data byte: All 0, all 1, 8 bits program, single PRBS 7, user program (max. 65535 byte)
IPv6 setting (RFC1883)	Any setting: Version, priority, flow label, payload length, next header, hop limit, address (source, destination) Data byte: All 0, all 1, 8 bits program, single PRBS 7, user program (max. 65535 byte)
Packet transmission setting	1 to 3 in IP/PPP (independently), IP/PPP sending pattern, packet sending interval (max. 100000 bytes), single/repeat, sending on/off, scramble ($X^{43} + 1$) on/off, control escape auto insertion, FCS error insertion (single), number of packet count display
Packet receiving/analysis	PPP frame calculation (count), scramble ($X^{43} + 1$) on/off setting, automatic analysis of control escape. Frame/capture memory (option) required data captured into the capture memory (max. 64 frames*2), IPv4/IPv6 select, IP address filter set

*1: The frame/capture memory (option) is required.

*2: Maximum 26 frames at 2488/9953 Mbits when MU150000A is inserted.

• IP-over-ATM (Option)*1

Bit rate	155.52, 622.08 Mbit/s
AAL5 edit pattern	IPv4/IPv6 selectable
IPv4 setting (RFC0791)	Any setting: Version, IHL, TOS, total length, ID, flags, fragment offset, TTL, protocol, address (source, destination) Header checksum: Auto calculate Data byte: All 0, all 1, 8 bit program, single PRBS 7, user program (max. 65535 bytes)
IPv6 setting (RFC1883)	Any setting: Version, priority, flow label, payload length, next header, hop limit, address (source, destination) Data byte: All 0, all 1, 8 bits program, single PRBS 7, user program (max. 65535 bytes)
Packet sending	Follow with AAL5 distribution setting
Packet receiving/analysis	Displays the IP packet from the data captured into cell capture memory (maximum 2016 cells), IPv4/IPv6 selectable

*1: MP0123A ATM Unit is required.

• General

Printer	Internal, external
Internal memory	Measurement settings memory: 10, Graphics memory: 15
Others	FDD, RS-232C (Option 01)*1, GPIB (Option 02)*1, Ethernet (Option 03)*1, video output (Option 04)*1, buzzer, clock, help, screen copy
EMC	EN61326: 1997/A1, 1998 (Class A) EN61000-3-2: 1995/A2, 1998 (Class A) EN61326: 1997/A1, 1998 (Annex A)
LVD	EN610101-1: 1993/A2, 1995 (Installation Category II, Pollution degree 2)
Dimensions and mass	320 (W) x 177 (H) x 350 (D) mm, 10 kg approx. (excluding plug-in units and options)
Power	100 to 240 Vac, 47.5 to 63 Hz, ≤500 VA
Temperature	0° to +40°C

*1: The video output, RS-232C, GPIB and Ethernet options cannot all be used simultaneously.

Only the video output + RS-232C, or video output + GPIB, or RS-232C + GPIB board, or Ethernet board combinations support simultaneous use, so change the board combinations according to the purpose.

• MU150005A/150006A/150007A Jitter Units

Bit rate	MU150005A: 2.048, 8.448, 34.368, 139.264, 155.52, 622.08 Mbit/s MU150006A: 1.544, 44.736, 51.84, 155.52, 622.08 Mbit/s MU150007A: 1.544, 2.048, 8.448, 34.368, 44.736, 139.264, 51.84, 155.52, 622.08 Mbit/s																																																																																																																																												
Jitter generation	<p>Conform to ITU-T O.171/Q.172 Modulation frequency: 0.1 Hz to 6 MHz Amplitude: 0 to 404.0 Ulp-p Resolution: 0.001 Ulp-p (2 UI range), 0.01 Ulp-p (16 UI range), 0.1 Ulp-p (80 UI range), 0.2 Ulp-p (400 UI range)</p> <table border="1" data-bbox="395 806 922 1129"> <thead> <tr> <th>Bit rate (Mbit/s)</th> <th>f1 (Hz)</th> <th>f2 (Hz)</th> <th>f3 (kHz)</th> <th>f4 (kHz)</th> <th>f5 (kHz)</th> <th>f6 (kHz)</th> <th>f7 (kHz)</th> </tr> </thead> <tbody> <tr><td>1.544</td><td>130</td><td>630</td><td>3.2</td><td>25</td><td>—</td><td>100</td><td>—</td></tr> <tr><td>2.048</td><td>300</td><td>1.5k</td><td>7.5</td><td>60</td><td>—</td><td>240</td><td>—</td></tr> <tr><td>8.448</td><td>1.1k</td><td>5.5k</td><td>28</td><td>220</td><td>—</td><td>880</td><td>—</td></tr> <tr><td>34.368</td><td>2.5k</td><td>13k</td><td>63</td><td>500</td><td>—</td><td>—</td><td>5000</td></tr> <tr><td>44.736</td><td>2.5k</td><td>13k</td><td>63</td><td>500</td><td>—</td><td>—</td><td>5000</td></tr> <tr><td>139.264</td><td>9k</td><td>45k</td><td>230</td><td>1800</td><td>6000</td><td>—</td><td>—</td></tr> <tr><td>51.84</td><td>2.5k</td><td>13k</td><td>63</td><td>500</td><td>—</td><td>—</td><td>5000</td></tr> <tr><td>155.52</td><td>7.5k</td><td>38k</td><td>190</td><td>1500</td><td>—</td><td>6000</td><td>—</td></tr> <tr><td>622.08</td><td>3k</td><td>15k</td><td>75</td><td>600</td><td>—</td><td>—</td><td>6000</td></tr> </tbody> </table> <p>Accuracy 2 UI range: ($\pm Q\%$ of setting) ± 0.02 Ulp-p, 16 UI range: ($\pm Q\%$ of setting) ± 0.2 Ulp-p, 80 UI range: ($\pm Q\%$ of setting) ± 1.2 Ulp-p, 400 UI range: ($\pm Q\%$ of setting) ± 6 Ulp-p</p> <table border="1" data-bbox="395 1209 804 1961"> <thead> <tr> <th>Bit rate (Mbit/s)</th> <th>Error Q</th> <th>Frequency range</th> </tr> </thead> <tbody> <tr><td rowspan="2">1.544</td><td>$\pm 12\%$</td><td>0.1 to 2 Hz</td></tr> <tr><td>$\pm 8\%$</td><td>2 Hz to 100 kHz</td></tr> <tr><td rowspan="2">2.048</td><td>$\pm 12\%$</td><td>0.1 to 10 Hz</td></tr> <tr><td>$\pm 8\%$</td><td>10 Hz to 240 kHz</td></tr> <tr><td rowspan="2">8.448</td><td>$\pm 12\%$</td><td>0.1 to 20 Hz</td></tr> <tr><td>$\pm 8\%$</td><td>20 Hz to 880 kHz</td></tr> <tr><td rowspan="3">34.368</td><td>$\pm 12\%$</td><td>0.1 to 100 Hz</td></tr> <tr><td>$\pm 8\%$</td><td>0.1 to 500 kHz</td></tr> <tr><td>$\pm 12\%$</td><td>500 kHz to 5 MHz</td></tr> <tr><td rowspan="2">44.736</td><td>$\pm 12\%$</td><td>0.1 to 2 Hz</td></tr> <tr><td>$\pm 8\%$</td><td>2 Hz to 5 MHz</td></tr> <tr><td rowspan="4">139.264</td><td>$\pm 12\%$</td><td>0.1 to 100 Hz</td></tr> <tr><td>$\pm 8\%$</td><td>0.1 to 500 kHz</td></tr> <tr><td>$\pm 12\%$</td><td>0.5 to 2 MHz</td></tr> <tr><td>$\pm 15\%$</td><td>2 to 6 MHz</td></tr> <tr><td rowspan="2">51.84</td><td>$\pm 12\%$</td><td>0.1 to 300 Hz</td></tr> <tr><td>$\pm 8\%$</td><td>300 Hz to 5 MHz</td></tr> <tr><td rowspan="3">155.52</td><td>$\pm 12\%$</td><td>0.1 to 500 Hz</td></tr> <tr><td>$\pm 8\%$</td><td>0.5 to 500 kHz</td></tr> <tr><td>$\pm 12\%$</td><td>0.5 to 6 MHz</td></tr> <tr><td rowspan="4">622.08</td><td>$\pm 12\%$</td><td>0.1 Hz to 1 kHz</td></tr> <tr><td>$\pm 8\%$</td><td>1 to 500 kHz</td></tr> <tr><td>$\pm 12\%$</td><td>0.5 to 2 MHz</td></tr> <tr><td>$\pm 15\%$</td><td>2 to 6 MHz</td></tr> </tbody> </table>	Bit rate (Mbit/s)	f1 (Hz)	f2 (Hz)	f3 (kHz)	f4 (kHz)	f5 (kHz)	f6 (kHz)	f7 (kHz)	1.544	130	630	3.2	25	—	100	—	2.048	300	1.5k	7.5	60	—	240	—	8.448	1.1k	5.5k	28	220	—	880	—	34.368	2.5k	13k	63	500	—	—	5000	44.736	2.5k	13k	63	500	—	—	5000	139.264	9k	45k	230	1800	6000	—	—	51.84	2.5k	13k	63	500	—	—	5000	155.52	7.5k	38k	190	1500	—	6000	—	622.08	3k	15k	75	600	—	—	6000	Bit rate (Mbit/s)	Error Q	Frequency range	1.544	$\pm 12\%$	0.1 to 2 Hz	$\pm 8\%$	2 Hz to 100 kHz	2.048	$\pm 12\%$	0.1 to 10 Hz	$\pm 8\%$	10 Hz to 240 kHz	8.448	$\pm 12\%$	0.1 to 20 Hz	$\pm 8\%$	20 Hz to 880 kHz	34.368	$\pm 12\%$	0.1 to 100 Hz	$\pm 8\%$	0.1 to 500 kHz	$\pm 12\%$	500 kHz to 5 MHz	44.736	$\pm 12\%$	0.1 to 2 Hz	$\pm 8\%$	2 Hz to 5 MHz	139.264	$\pm 12\%$	0.1 to 100 Hz	$\pm 8\%$	0.1 to 500 kHz	$\pm 12\%$	0.5 to 2 MHz	$\pm 15\%$	2 to 6 MHz	51.84	$\pm 12\%$	0.1 to 300 Hz	$\pm 8\%$	300 Hz to 5 MHz	155.52	$\pm 12\%$	0.1 to 500 Hz	$\pm 8\%$	0.5 to 500 kHz	$\pm 12\%$	0.5 to 6 MHz	622.08	$\pm 12\%$	0.1 Hz to 1 kHz	$\pm 8\%$	1 to 500 kHz	$\pm 12\%$	0.5 to 2 MHz	$\pm 15\%$	2 to 6 MHz
Bit rate (Mbit/s)	f1 (Hz)	f2 (Hz)	f3 (kHz)	f4 (kHz)	f5 (kHz)	f6 (kHz)	f7 (kHz)																																																																																																																																						
1.544	130	630	3.2	25	—	100	—																																																																																																																																						
2.048	300	1.5k	7.5	60	—	240	—																																																																																																																																						
8.448	1.1k	5.5k	28	220	—	880	—																																																																																																																																						
34.368	2.5k	13k	63	500	—	—	5000																																																																																																																																						
44.736	2.5k	13k	63	500	—	—	5000																																																																																																																																						
139.264	9k	45k	230	1800	6000	—	—																																																																																																																																						
51.84	2.5k	13k	63	500	—	—	5000																																																																																																																																						
155.52	7.5k	38k	190	1500	—	6000	—																																																																																																																																						
622.08	3k	15k	75	600	—	—	6000																																																																																																																																						
Bit rate (Mbit/s)	Error Q	Frequency range																																																																																																																																											
1.544	$\pm 12\%$	0.1 to 2 Hz																																																																																																																																											
	$\pm 8\%$	2 Hz to 100 kHz																																																																																																																																											
2.048	$\pm 12\%$	0.1 to 10 Hz																																																																																																																																											
	$\pm 8\%$	10 Hz to 240 kHz																																																																																																																																											
8.448	$\pm 12\%$	0.1 to 20 Hz																																																																																																																																											
	$\pm 8\%$	20 Hz to 880 kHz																																																																																																																																											
34.368	$\pm 12\%$	0.1 to 100 Hz																																																																																																																																											
	$\pm 8\%$	0.1 to 500 kHz																																																																																																																																											
	$\pm 12\%$	500 kHz to 5 MHz																																																																																																																																											
44.736	$\pm 12\%$	0.1 to 2 Hz																																																																																																																																											
	$\pm 8\%$	2 Hz to 5 MHz																																																																																																																																											
139.264	$\pm 12\%$	0.1 to 100 Hz																																																																																																																																											
	$\pm 8\%$	0.1 to 500 kHz																																																																																																																																											
	$\pm 12\%$	0.5 to 2 MHz																																																																																																																																											
	$\pm 15\%$	2 to 6 MHz																																																																																																																																											
51.84	$\pm 12\%$	0.1 to 300 Hz																																																																																																																																											
	$\pm 8\%$	300 Hz to 5 MHz																																																																																																																																											
155.52	$\pm 12\%$	0.1 to 500 Hz																																																																																																																																											
	$\pm 8\%$	0.5 to 500 kHz																																																																																																																																											
	$\pm 12\%$	0.5 to 6 MHz																																																																																																																																											
622.08	$\pm 12\%$	0.1 Hz to 1 kHz																																																																																																																																											
	$\pm 8\%$	1 to 500 kHz																																																																																																																																											
	$\pm 12\%$	0.5 to 2 MHz																																																																																																																																											
	$\pm 15\%$	2 to 6 MHz																																																																																																																																											

Continued on next page

Frequency offset	Range: ± 999.9 ppm/0.1 ppm steps (jitter off), ± 100 ppm/0.1 ppm steps (jitter on/off) Accuracy: ± 0.1 ppm after power-on, calibrates after 60 min warm-up, $23^\circ \pm 5^\circ\text{C}$																																																																																																																																																																																																																																																						
Auxiliary interface	External modulation input, External 5/10 MHz reference input, Jitter clock/Jitter reference output, Wander reference output																																																																																																																																																																																																																																																						
Jitter measurement	<p>Conform to ITU-T O.171/O.172 Modulation frequency: 0.1 Hz to 5 MHz Amplitude: 0.0 to 400 UI (800 UI: at 622M) Resolution: 0.001 Ulp-p/0.001 Ulrms (2 UI range), 0.01 Ulp-p/0.01 Ulrms (8 UI/20 UI range), 0.2 Ulp-p (400 UI range), 0.5 Ulp-p (800 UI range)</p> <table border="1"> <thead> <tr> <th rowspan="2">Bit rate (Mbit/s)</th> <th colspan="2">A1 (Ulp-p)</th> <th colspan="2">A2 (Ulp-p)</th> <th colspan="2">F1* (Hz)</th> <th colspan="2">F2 (Hz)</th> <th>F3 (Hz)</th> <th>F4 (Hz)</th> </tr> <tr> <th>—</th> <th>Full</th> <th>Wide</th> <th>Full</th> <th>Wide</th> <th>Full</th> <th>Wide</th> <th>—</th> <th>—</th> </tr> </thead> <tbody> <tr><td>1.544</td><td>0.5</td><td>8</td><td>2</td><td>0.1</td><td>10</td><td>1.25k</td><td>5k</td><td>20k</td><td>40k</td></tr> <tr><td>2.048</td><td>0.5</td><td>8</td><td>2</td><td>0.1</td><td>10</td><td>3.75k</td><td>15k</td><td>60k</td><td>100k</td></tr> <tr><td>8.448</td><td>0.5</td><td>—</td><td>2</td><td>—</td><td>10</td><td>—</td><td>50k</td><td>200k</td><td>400k</td></tr> <tr><td>34.368</td><td>0.5</td><td>8</td><td>2</td><td>0.1</td><td>10</td><td>18.75k</td><td>75k</td><td>300k</td><td>800k</td></tr> <tr><td>44.736</td><td>0.5</td><td>8</td><td>2</td><td>0.1</td><td>10</td><td>25k</td><td>100k</td><td>400k</td><td>400k</td></tr> <tr><td>139.264</td><td>0.5</td><td>8</td><td>2</td><td>0.1</td><td>10</td><td>50k</td><td>200k</td><td>800k</td><td>3.5M</td></tr> <tr><td>51.84</td><td>0.5</td><td>8</td><td>2</td><td>1</td><td>10</td><td>25k</td><td>100k</td><td>400k</td><td>400k</td></tr> <tr><td>155.52</td><td>0.4</td><td>8</td><td>2</td><td>1</td><td>10</td><td>25k</td><td>100k</td><td>500k</td><td>1.3M</td></tr> <tr><td>622.08</td><td>0.3</td><td>8</td><td>2</td><td>1</td><td>10</td><td>75k</td><td>300k</td><td>2M</td><td>5M</td></tr> </tbody> </table> <p>*F1 = 100 Hz at RMS</p> <table border="1"> <thead> <tr> <th rowspan="2">Bit rate (Mbit/s)</th> <th>A1 (Ulp-p)</th> <th colspan="2">F1* (Hz)</th> <th>F2 (Hz)</th> <th>F3 (Hz)</th> <th>F4 (Hz)</th> </tr> <tr> <th>—</th> <th>Full</th> <th>Wide</th> <th>—</th> <th>—</th> <th>—</th> </tr> </thead> <tbody> <tr><td>1.544</td><td>0.67</td><td>0.1</td><td>1</td><td>600</td><td>15k</td><td>15k</td></tr> <tr><td>2.048</td><td>1.67</td><td>0.1</td><td>1</td><td>1.5k</td><td>18k</td><td>18k</td></tr> <tr><td>8.448</td><td>1.43</td><td>0.1</td><td>1</td><td>5k</td><td>70k</td><td>70k</td></tr> <tr><td>34.368</td><td>0.5</td><td>0.1</td><td>1</td><td>8k</td><td>300k</td><td>300k</td></tr> <tr><td>44.736</td><td>0.5</td><td>0.1</td><td>1</td><td>10k</td><td>400k</td><td>400k</td></tr> <tr><td>139.264</td><td>0.5</td><td>0.1</td><td>1</td><td>20k</td><td>800k</td><td>1.2M</td></tr> <tr><td>51.84</td><td>0.5</td><td>1</td><td>1</td><td>10k</td><td>400k</td><td>400k</td></tr> <tr><td>155.52</td><td>0.4</td><td>1</td><td>1</td><td>10k</td><td>500k</td><td>1.3M</td></tr> <tr><td>622.08</td><td>0.3</td><td>1</td><td>1</td><td>30k</td><td>2M</td><td>5M</td></tr> </tbody> </table> <p>*F1 = 100 Hz at RMS</p> <table border="1"> <thead> <tr> <th rowspan="2">Bit rate (Mbit/s)</th> <th>A1 (Ulp-p)</th> <th>A2 (Ulp-p)</th> <th>F1** (Hz)</th> <th>F2 (Hz)</th> <th>F3 (Hz)</th> </tr> </thead> <tbody> <tr><td>1.544</td><td>20</td><td>400</td><td>0.1</td><td>10</td><td>200</td></tr> <tr><td>2.048</td><td>20</td><td>400</td><td>0.1</td><td>10</td><td>200</td></tr> <tr><td>8.448</td><td>20</td><td>400</td><td>0.1</td><td>10</td><td>200</td></tr> <tr><td>34.368</td><td>20</td><td>400</td><td>0.1</td><td>10</td><td>200</td></tr> <tr><td>44.736</td><td>20</td><td>400</td><td>0.1</td><td>10</td><td>200</td></tr> <tr><td>139.264</td><td>20</td><td>400</td><td>0.1</td><td>10</td><td>200</td></tr> <tr><td>51.84</td><td>20</td><td>400</td><td>0.1</td><td>10</td><td>200</td></tr> <tr><td>155.52</td><td>4</td><td>400</td><td>0.1</td><td>10</td><td>1k</td></tr> <tr><td>622.08</td><td>4</td><td>800</td><td>0.1</td><td>10</td><td>2k</td></tr> </tbody> </table> <p>** : Full band only</p>	Bit rate (Mbit/s)	A1 (Ulp-p)		A2 (Ulp-p)		F1* (Hz)		F2 (Hz)		F3 (Hz)	F4 (Hz)	—	Full	Wide	Full	Wide	Full	Wide	—	—	1.544	0.5	8	2	0.1	10	1.25k	5k	20k	40k	2.048	0.5	8	2	0.1	10	3.75k	15k	60k	100k	8.448	0.5	—	2	—	10	—	50k	200k	400k	34.368	0.5	8	2	0.1	10	18.75k	75k	300k	800k	44.736	0.5	8	2	0.1	10	25k	100k	400k	400k	139.264	0.5	8	2	0.1	10	50k	200k	800k	3.5M	51.84	0.5	8	2	1	10	25k	100k	400k	400k	155.52	0.4	8	2	1	10	25k	100k	500k	1.3M	622.08	0.3	8	2	1	10	75k	300k	2M	5M	Bit rate (Mbit/s)	A1 (Ulp-p)	F1* (Hz)		F2 (Hz)	F3 (Hz)	F4 (Hz)	—	Full	Wide	—	—	—	1.544	0.67	0.1	1	600	15k	15k	2.048	1.67	0.1	1	1.5k	18k	18k	8.448	1.43	0.1	1	5k	70k	70k	34.368	0.5	0.1	1	8k	300k	300k	44.736	0.5	0.1	1	10k	400k	400k	139.264	0.5	0.1	1	20k	800k	1.2M	51.84	0.5	1	1	10k	400k	400k	155.52	0.4	1	1	10k	500k	1.3M	622.08	0.3	1	1	30k	2M	5M	Bit rate (Mbit/s)	A1 (Ulp-p)	A2 (Ulp-p)	F1** (Hz)	F2 (Hz)	F3 (Hz)	1.544	20	400	0.1	10	200	2.048	20	400	0.1	10	200	8.448	20	400	0.1	10	200	34.368	20	400	0.1	10	200	44.736	20	400	0.1	10	200	139.264	20	400	0.1	10	200	51.84	20	400	0.1	10	200	155.52	4	400	0.1	10	1k	622.08	4	800	0.1	10	2k
	Bit rate (Mbit/s)		A1 (Ulp-p)		A2 (Ulp-p)		F1* (Hz)		F2 (Hz)		F3 (Hz)	F4 (Hz)																																																																																																																																																																																																																																											
		—	Full	Wide	Full	Wide	Full	Wide	—	—																																																																																																																																																																																																																																													
	1.544	0.5	8	2	0.1	10	1.25k	5k	20k	40k																																																																																																																																																																																																																																													
2.048	0.5	8	2	0.1	10	3.75k	15k	60k	100k																																																																																																																																																																																																																																														
8.448	0.5	—	2	—	10	—	50k	200k	400k																																																																																																																																																																																																																																														
34.368	0.5	8	2	0.1	10	18.75k	75k	300k	800k																																																																																																																																																																																																																																														
44.736	0.5	8	2	0.1	10	25k	100k	400k	400k																																																																																																																																																																																																																																														
139.264	0.5	8	2	0.1	10	50k	200k	800k	3.5M																																																																																																																																																																																																																																														
51.84	0.5	8	2	1	10	25k	100k	400k	400k																																																																																																																																																																																																																																														
155.52	0.4	8	2	1	10	25k	100k	500k	1.3M																																																																																																																																																																																																																																														
622.08	0.3	8	2	1	10	75k	300k	2M	5M																																																																																																																																																																																																																																														
Bit rate (Mbit/s)	A1 (Ulp-p)	F1* (Hz)		F2 (Hz)	F3 (Hz)	F4 (Hz)																																																																																																																																																																																																																																																	
	—	Full	Wide	—	—	—																																																																																																																																																																																																																																																	
1.544	0.67	0.1	1	600	15k	15k																																																																																																																																																																																																																																																	
2.048	1.67	0.1	1	1.5k	18k	18k																																																																																																																																																																																																																																																	
8.448	1.43	0.1	1	5k	70k	70k																																																																																																																																																																																																																																																	
34.368	0.5	0.1	1	8k	300k	300k																																																																																																																																																																																																																																																	
44.736	0.5	0.1	1	10k	400k	400k																																																																																																																																																																																																																																																	
139.264	0.5	0.1	1	20k	800k	1.2M																																																																																																																																																																																																																																																	
51.84	0.5	1	1	10k	400k	400k																																																																																																																																																																																																																																																	
155.52	0.4	1	1	10k	500k	1.3M																																																																																																																																																																																																																																																	
622.08	0.3	1	1	30k	2M	5M																																																																																																																																																																																																																																																	
Bit rate (Mbit/s)	A1 (Ulp-p)	A2 (Ulp-p)	F1** (Hz)	F2 (Hz)	F3 (Hz)																																																																																																																																																																																																																																																		
	1.544	20	400	0.1	10	200																																																																																																																																																																																																																																																	
2.048	20	400	0.1	10	200																																																																																																																																																																																																																																																		
8.448	20	400	0.1	10	200																																																																																																																																																																																																																																																		
34.368	20	400	0.1	10	200																																																																																																																																																																																																																																																		
44.736	20	400	0.1	10	200																																																																																																																																																																																																																																																		
139.264	20	400	0.1	10	200																																																																																																																																																																																																																																																		
51.84	20	400	0.1	10	200																																																																																																																																																																																																																																																		
155.52	4	400	0.1	10	1k																																																																																																																																																																																																																																																		
622.08	4	800	0.1	10	2k																																																																																																																																																																																																																																																		

Continued on next page

Filter:

Conform to O.171/O.172, LP, HP0 + LP, HP1 + LP, HP2 + LP, HP + LP, user

Bit rate (Mbit/s)	HP0 (Hz)	HP1 (Hz)	HP2 (Hz)	HP2' (Hz)	HP (Hz)	LP (Hz)
1.544	10	10	8k	—	12k	40k
2.048	10	20	18k	700	12k	100k
8.448	10	20	3k	80k	12k	400k
34.368	10	100	10k	—	12k	800k
44.736	10	10	30k	—	12k	400k
139.264	10	200	10k	—	12k	3.5M
51.84	10	100	20k	—	12k	400k
155.52	10	500	65k	—	12k	1.3M
622.08	10	1k	250k	—	12k	5M

Accuracy (Ulp-p, UI+p, UI-p)

2 UI range: $\pm R\%$ of reading $\pm W$ Ulp-p, 20 UI range: $\pm R\%$ of reading $\pm W$ Ulp-p, 400 UI range: $\pm R\%$ of reading $\pm W$ Ulp-p, 800 UI range: $\pm R\%$ of reading $\pm W$ Ulp-p

Fixed error [W]

Ulp-p

Bit rate (Mbit/s)	Pseudo-random signal								
	HP1 + LP				HP2 + LP				Bit length
	2 UI	8 UI	20 UI	400/800 UI	2 UI	8 UI	20 UI		
1.544	0.040	0.08	0.22	3.5	0.025	0.05	0.15	$2^{20} - 1$	
2.048	0.040	0.08	0.22	3.5	0.025	0.05	0.15	$2^{15} - 1$	
8.448	0.040	—	0.22	3.5	0.025	—	0.15	$2^{15} - 1$	
34.368	0.040	0.08	0.22	3.5	0.025	0.05	0.15	$2^{23} - 1$	
44.736	0.040	0.08	0.22	3.5	0.025	0.05	0.15	$2^{15} - 1$	
139.264	0.040	0.08	0.30	5.0	0.025	0.05	0.15	$2^{23} - 1$	

Bit rate (Mbit/s)	Clock signal							
	HP1 + LP				HP2 + LP			
	2 UI	8 UI	20 UI	400/800 UI	2 UI	8 UI	20 UI	
1.544	0.015	0.03	0.10	1.6	0.010	0.02	0.08	
2.048	0.015	0.03	0.10	1.6	0.010	0.02	0.08	
8.448	0.015	—	0.10	1.6	0.010	—	0.08	
34.368	0.030	0.06	0.18	2.8	0.020	0.04	0.15	
44.736	0.030	0.06	0.18	2.8	0.020	0.04	0.15	
139.264	0.030	0.06	0.22	3.8	0.020	0.04	0.20	

Bit rate (Mbit/s)	SONET/SDH signal								
	HP1 + LP				HP2 + LP				Container
	2 UI	8 UI	20 UI	400/800 UI	2 UI	8 UI	20 UI		
51.84e	0.070	0.14	0.30	5.0	0.050	0.10	0.20	VC3	
51.84o	0.070	0.14	0.30	5.0	0.050	0.10	0.20	VC3	
155.52e	0.070	0.14	0.30	5.0	0.025	0.05	0.20	VC4	
155.52o	0.070	0.14	0.30	5.0	0.050	0.10	0.20	VC4	
622.08	0.100	0.20	0.30	10.0	0.050	0.10	0.20	VC4-4c	

At PRBS $2^{23} - 1$

Bit rate (Mbit/s)	Clock signal							
	HP1 + LP				HP2 + LP			
	2 UI	8 UI	20 UI	400/800 UI	2 UI	8 UI	20 UI	
51.84e	0.050	0.10	0.22	3.8	0.030	0.06	0.20	
155.52e	0.050	0.10	0.22	3.8	0.030	0.06	0.20	
622.08	0.050	0.10	0.22	5.0	0.030	0.06	0.20	

Frequency error [R]

Frequency error	Frequency range
$\pm 10\%$	0.1 to 20 Hz
$\pm 7\%$	20 Hz to 300 kHz
$\pm 8\%$	300 kHz to 1 MHz
$\pm 10\%$	1 to 3 MHz
$\pm 15\%$	3 to 5 MHz

Jitter measurement

Continued on next page

Jitter measurement	Ulrms 2 UI range: $\pm R\% \pm Y$ Ulrms, 20 UI range: $\pm R\% \pm Y$ Ulrms																																																																				
	Fixed error [Y] Ulrms																																																																				
	<table border="1"> <thead> <tr> <th rowspan="3">Bit rate (Mbit/s)</th> <th colspan="4">Pseudo-random signal</th> </tr> <tr> <th colspan="3">HP + LP</th> <th rowspan="2">Bit length</th> </tr> <tr> <th>2 UI</th> <th>8 UI</th> <th>20 UI</th> </tr> </thead> <tbody> <tr><td>1.544</td><td>0.006</td><td>0.02</td><td>0.04</td><td>$2^{20} - 1$</td></tr> <tr><td>2.048</td><td>0.006</td><td>0.02</td><td>0.04</td><td>$2^{15} - 1$</td></tr> <tr><td>8.448</td><td>0.006</td><td>—</td><td>0.04</td><td>$2^{15} - 1$</td></tr> <tr><td>34.368</td><td>0.008</td><td>0.02</td><td>0.05</td><td>$2^{23} - 1$</td></tr> <tr><td>44.736</td><td>0.008</td><td>0.02</td><td>0.05</td><td>$2^{15} - 1$</td></tr> <tr><td>139.264</td><td>0.008</td><td>0.02</td><td>0.05</td><td>$2^{23} - 1$</td></tr> </tbody> </table>	Bit rate (Mbit/s)	Pseudo-random signal				HP + LP			Bit length	2 UI	8 UI	20 UI	1.544	0.006	0.02	0.04	$2^{20} - 1$	2.048	0.006	0.02	0.04	$2^{15} - 1$	8.448	0.006	—	0.04	$2^{15} - 1$	34.368	0.008	0.02	0.05	$2^{23} - 1$	44.736	0.008	0.02	0.05	$2^{15} - 1$	139.264	0.008	0.02	0.05	$2^{23} - 1$																										
	Bit rate (Mbit/s)		Pseudo-random signal																																																																		
			HP + LP			Bit length																																																															
		2 UI	8 UI	20 UI																																																																	
	1.544	0.006	0.02	0.04	$2^{20} - 1$																																																																
	2.048	0.006	0.02	0.04	$2^{15} - 1$																																																																
	8.448	0.006	—	0.04	$2^{15} - 1$																																																																
	34.368	0.008	0.02	0.05	$2^{23} - 1$																																																																
44.736	0.008	0.02	0.05	$2^{15} - 1$																																																																	
139.264	0.008	0.02	0.05	$2^{23} - 1$																																																																	
<table border="1"> <thead> <tr> <th rowspan="3">Bit rate (Mbit/s)</th> <th colspan="4">Clock signal</th> </tr> <tr> <th colspan="3">HP + LP</th> <th rowspan="2"></th> </tr> <tr> <th>2 UI</th> <th>8 UI</th> <th>20 UI</th> </tr> </thead> <tbody> <tr><td>1.544</td><td>0.004</td><td>0.02</td><td>0.03</td><td></td></tr> <tr><td>2.048</td><td>0.004</td><td>0.02</td><td>0.03</td><td></td></tr> <tr><td>8.448</td><td>0.004</td><td>—</td><td>0.03</td><td></td></tr> <tr><td>34.368</td><td>0.006</td><td>0.02</td><td>0.04</td><td></td></tr> <tr><td>44.736</td><td>0.006</td><td>0.02</td><td>0.04</td><td></td></tr> <tr><td>139.264</td><td>0.006</td><td>0.02</td><td>0.04</td><td></td></tr> </tbody> </table>	Bit rate (Mbit/s)	Clock signal				HP + LP				2 UI	8 UI	20 UI	1.544	0.004	0.02	0.03		2.048	0.004	0.02	0.03		8.448	0.004	—	0.03		34.368	0.006	0.02	0.04		44.736	0.006	0.02	0.04		139.264	0.006	0.02	0.04																												
Bit rate (Mbit/s)		Clock signal																																																																			
		HP + LP																																																																			
	2 UI	8 UI	20 UI																																																																		
1.544	0.004	0.02	0.03																																																																		
2.048	0.004	0.02	0.03																																																																		
8.448	0.004	—	0.03																																																																		
34.368	0.006	0.02	0.04																																																																		
44.736	0.006	0.02	0.04																																																																		
139.264	0.006	0.02	0.04																																																																		
<table border="1"> <thead> <tr> <th rowspan="3">Bit rate (Mbit/s)</th> <th colspan="4">SONET/SDH signal</th> </tr> <tr> <th colspan="3">HP + LP</th> <th rowspan="2">Container</th> </tr> <tr> <th>2 UI</th> <th>8 UI</th> <th>20 UI</th> </tr> </thead> <tbody> <tr><td>51.84e</td><td>0.010</td><td>0.02</td><td>0.06</td><td>VC3</td></tr> <tr><td>51.84o</td><td>0.010</td><td>0.02</td><td>0.06</td><td>VC3</td></tr> <tr><td>155.52e</td><td>0.010</td><td>0.02</td><td>0.06</td><td>VC4</td></tr> <tr><td>155.52o</td><td>0.010</td><td>0.02</td><td>0.06</td><td>VC4</td></tr> <tr><td>622.08</td><td>0.012</td><td>0.03</td><td>0.08</td><td>VC4-4c</td></tr> </tbody> </table>	Bit rate (Mbit/s)	SONET/SDH signal				HP + LP			Container	2 UI	8 UI	20 UI	51.84e	0.010	0.02	0.06	VC3	51.84o	0.010	0.02	0.06	VC3	155.52e	0.010	0.02	0.06	VC4	155.52o	0.010	0.02	0.06	VC4	622.08	0.012	0.03	0.08	VC4-4c																																
Bit rate (Mbit/s)		SONET/SDH signal																																																																			
		HP + LP			Container																																																																
	2 UI	8 UI	20 UI																																																																		
51.84e	0.010	0.02	0.06	VC3																																																																	
51.84o	0.010	0.02	0.06	VC3																																																																	
155.52e	0.010	0.02	0.06	VC4																																																																	
155.52o	0.010	0.02	0.06	VC4																																																																	
622.08	0.012	0.03	0.08	VC4-4c																																																																	
<table border="1"> <thead> <tr> <th colspan="2">Clock signal</th> </tr> <tr> <th colspan="2">HP + LP</th> </tr> <tr> <th>2 UI</th> <th>8 UI</th> </tr> </thead> <tbody> <tr><td>51.84e</td><td>0.008</td></tr> <tr><td>155.52e</td><td>0.008</td></tr> <tr><td>622.08</td><td>0.010</td></tr> </tbody> </table>	Clock signal		HP + LP		2 UI	8 UI	51.84e	0.008	155.52e	0.008	622.08	0.010																																																									
Clock signal																																																																					
HP + LP																																																																					
2 UI	8 UI																																																																				
51.84e	0.008																																																																				
155.52e	0.008																																																																				
622.08	0.010																																																																				
At PRBS $2^{23} - 1$																																																																					
Frequency error [R]																																																																					
<table border="1"> <thead> <tr> <th>Frequency error</th> <th>Frequency range</th> </tr> </thead> <tbody> <tr><td>$\pm 10\%$</td><td>0.1 to 20 Hz</td></tr> <tr><td>$\pm 7\%$</td><td>20 Hz to 300 kHz</td></tr> <tr><td>$\pm 8\%$</td><td>300 kHz to 1 MHz</td></tr> <tr><td>$\pm 10\%$</td><td>1 to 3 MHz</td></tr> <tr><td>$\pm 15\%$</td><td>3 to 5 MHz</td></tr> </tbody> </table>	Frequency error	Frequency range	$\pm 10\%$	0.1 to 20 Hz	$\pm 7\%$	20 Hz to 300 kHz	$\pm 8\%$	300 kHz to 1 MHz	$\pm 10\%$	1 to 3 MHz	$\pm 15\%$	3 to 5 MHz																																																									
Frequency error	Frequency range																																																																				
$\pm 10\%$	0.1 to 20 Hz																																																																				
$\pm 7\%$	20 Hz to 300 kHz																																																																				
$\pm 8\%$	300 kHz to 1 MHz																																																																				
$\pm 10\%$	1 to 3 MHz																																																																				
$\pm 15\%$	3 to 5 MHz																																																																				
Hit measurement	Count, seconds, % free Seconds																																																																				
Frequency measurement	Resolution: 0.1 ppm, Display: Hz or ppm (After power-on, calibrates after 60 min warm-up, $23^{\circ} \pm 5^{\circ}C$)																																																																				
Auxiliary interface	Demodulation output, Clock/Reference input																																																																				
Jitter auto measurement	Jitter tolerance measurement: Evaluates jitter tolerance point automatically Jitter sweep measurement: Conforms to high-speed jitter tolerance evaluation for mass production, etc. Jitter transfer measurement: High dynamic range measurement by selective level method (variable) Jitter frequency measurement: Measures the mapping jitter automatically Frequency sweep measurement: Measures the jitter tolerance automatically while changing the offset																																																																				
Line wander generation	Modulation frequency: 10 μ Hz to 10 Hz (sine wave) Amplitude: 0 to 400,000 UI (10 Ulp-p steps) <table border="1"> <thead> <tr> <th>Bit rate (Mbit/s)</th> <th>f0 (μHz)</th> <th>f1 (mHz)</th> <th>f2 (Hz)</th> <th>A0 (Ulp-p)</th> <th>A1 (Ulp-p)</th> </tr> </thead> <tbody> <tr><td>1.544</td><td>10</td><td>20</td><td>10</td><td>400,000</td><td>800</td></tr> <tr><td>2.048</td><td>10</td><td>20</td><td>10</td><td>400,000</td><td>800</td></tr> <tr><td>8.448</td><td>10</td><td>200</td><td>10</td><td>400,000</td><td>8,000</td></tr> <tr><td>34.368</td><td>10</td><td>400</td><td>10</td><td>400,000</td><td>16,000</td></tr> <tr><td>44.736</td><td>10</td><td>400</td><td>10</td><td>400,000</td><td>16,000</td></tr> <tr><td>139.264</td><td>10</td><td>2,000</td><td>10</td><td>400,000</td><td>80,000</td></tr> <tr><td>51.84</td><td>10</td><td>400</td><td>10</td><td>400,000</td><td>16,000</td></tr> <tr><td>155.52</td><td>10</td><td>2,000</td><td>10</td><td>400,000</td><td>80,000</td></tr> <tr><td>622.08</td><td>10</td><td>400</td><td>10</td><td>400,000</td><td>16,000</td></tr> </tbody> </table> Accuracy: $\pm Q\%$ of setting ± 100 Ulp-p <table border="1"> <thead> <tr> <th>Error Q</th> <th>Frequency range</th> </tr> </thead> <tbody> <tr><td>$\pm 8\%$</td><td>10 μHz to 0.125 Hz</td></tr> <tr><td>$\pm 12\%$</td><td>0.125 Hz to 1 Hz</td></tr> <tr><td>$\pm 15\%$</td><td>1 to 10 Hz</td></tr> </tbody> </table>	Bit rate (Mbit/s)	f0 (μ Hz)	f1 (mHz)	f2 (Hz)	A0 (Ulp-p)	A1 (Ulp-p)	1.544	10	20	10	400,000	800	2.048	10	20	10	400,000	800	8.448	10	200	10	400,000	8,000	34.368	10	400	10	400,000	16,000	44.736	10	400	10	400,000	16,000	139.264	10	2,000	10	400,000	80,000	51.84	10	400	10	400,000	16,000	155.52	10	2,000	10	400,000	80,000	622.08	10	400	10	400,000	16,000	Error Q	Frequency range	$\pm 8\%$	10 μ Hz to 0.125 Hz	$\pm 12\%$	0.125 Hz to 1 Hz	$\pm 15\%$	1 to 10 Hz
Bit rate (Mbit/s)	f0 (μ Hz)	f1 (mHz)	f2 (Hz)	A0 (Ulp-p)	A1 (Ulp-p)																																																																
1.544	10	20	10	400,000	800																																																																
2.048	10	20	10	400,000	800																																																																
8.448	10	200	10	400,000	8,000																																																																
34.368	10	400	10	400,000	16,000																																																																
44.736	10	400	10	400,000	16,000																																																																
139.264	10	2,000	10	400,000	80,000																																																																
51.84	10	400	10	400,000	16,000																																																																
155.52	10	2,000	10	400,000	80,000																																																																
622.08	10	400	10	400,000	16,000																																																																
Error Q	Frequency range																																																																				
$\pm 8\%$	10 μ Hz to 0.125 Hz																																																																				
$\pm 12\%$	0.125 Hz to 1 Hz																																																																				
$\pm 15\%$	1 to 10 Hz																																																																				
Wander auto measurement	Automatically evaluates the wander of the sine wave by the wander sweep measurement																																																																				

Continued on next page

Reference wander generation (Option 03)	Off: Able to set non-modulated status TDEV mask: The 37 types of TDEV masks that are regulated by ITU-T, ETSI, ANSI, and Bellcore standards are available as default. It is possible to add the wander modulation on the user specified TDEV mask. Transient: It is possible to change the A ($1 - e^{-63.7t}$) phase by the timing of the start. Signal off: It is possible to disconnect the standard signal.
Wander measurement (Option 02)	Conform to ITU-T O.172 Reference input: 2.048M (HDB3, Clock), 1.544M (AMI/B8ZS, Clock), 64k + 8 kHz, 5 MHz, 10 MHz Sampling frequency: 40 Hz, 1 Hz, 0.1 Hz, 5 mHz (select by MX150001B) Measurement range P-P: 0.0 to 2E10 ns, +P/-P: 0.0 to 1E10 ns, TIE: 0.0 to $\pm 1E10$ ns Accuracy: Conform to ITU-T O.172 Measurement time: 10 to 1×10^8 s (max. 120, 000 s; MP1570A only) Wander application (requires MX150001B Wander Application Software) TIE: Max. 1×10^8 s, MTIE: Max. 1×10^8 s, TDEV: Max. 1×10^6 s Frequency offset: Measurement conforms to ANSI T1.105.09 Frequency drift rate: Measurement conforms to ANSI T1.105.09 MRTIE: The evaluation separated from the wander by a frequency offset Wander tolerance (TDEV) measurement: Evaluation by the various TDEV mask generations Wander transfer (TDEV) measurement: Calibration method by simulation, outputting results by the one measurement

• MU150011A 2.5G Jitter Unit

Jitter generation	Conforms to ITU-T O.172 Frequency: 2488.32 MHz Modulation frequency: 0.1 Hz to 20 MHz Amplitude: 0 to 808.0 Ulp-p Resolution: 0.001 Ulp-p (2 UI range), 0.01 Ulp-p (20 UI range), 0.4 Ulp-p (800 UI range) <table border="1" data-bbox="395 1066 911 1150"> <thead> <tr> <th>Bit rate (Mbit/s)</th> <th>F1 (Hz)</th> <th>F1' (Hz)</th> <th>F2* (kHz)</th> <th>F2'' (kHz)</th> <th>F3* (MHz)</th> <th>F4* (MHz)</th> <th>F5* (MHz)</th> </tr> </thead> <tbody> <tr> <td>2488.32</td> <td>0.1</td> <td>60</td> <td>2.5</td> <td>30</td> <td>1.2</td> <td>2</td> <td>20</td> </tr> </tbody> </table> <p style="text-align: center;">*Typical value</p> Accuracy 2 UI range: ($\pm Q\%$ of setting) ± 0.02 Ulp-p, 20 UI range: ($\pm Q\%$ of setting) ± 0.3 Ulp-p, 800 UI range: ($\pm Q\%$ of setting) ± 12.5 Ulp-p <table border="1" data-bbox="395 1226 866 1396"> <thead> <tr> <th>Bit rate (Mbit/s)</th> <th>Error Q</th> <th>Frequency range</th> </tr> </thead> <tbody> <tr> <td rowspan="4">2488.32</td> <td>$\pm 12\%$</td> <td>0.1 Hz to 5 kHz</td> </tr> <tr> <td>$\pm 8\%$</td> <td>5 to 500 kHz</td> </tr> <tr> <td>$\pm 12\%$</td> <td>0.5 to 2 MHz</td> </tr> <tr> <td>$\pm 15\%$</td> <td>2 to 20 MHz</td> </tr> </tbody> </table>	Bit rate (Mbit/s)	F1 (Hz)	F1' (Hz)	F2* (kHz)	F2'' (kHz)	F3* (MHz)	F4* (MHz)	F5* (MHz)	2488.32	0.1	60	2.5	30	1.2	2	20	Bit rate (Mbit/s)	Error Q	Frequency range	2488.32	$\pm 12\%$	0.1 Hz to 5 kHz	$\pm 8\%$	5 to 500 kHz	$\pm 12\%$	0.5 to 2 MHz	$\pm 15\%$	2 to 20 MHz
Bit rate (Mbit/s)	F1 (Hz)	F1' (Hz)	F2* (kHz)	F2'' (kHz)	F3* (MHz)	F4* (MHz)	F5* (MHz)																						
2488.32	0.1	60	2.5	30	1.2	2	20																						
Bit rate (Mbit/s)	Error Q	Frequency range																											
2488.32	$\pm 12\%$	0.1 Hz to 5 kHz																											
	$\pm 8\%$	5 to 500 kHz																											
	$\pm 12\%$	0.5 to 2 MHz																											
	$\pm 15\%$	2 to 20 MHz																											
Frequency offset	Range: ± 100 ppm/0.1 ppm steps (jitter on/off) Accuracy: ± 0.1 ppm (after power-on, calibrate after 60 min warm-up, 23 ± 5 °C)																												
Auxiliary interface	External clock input, Jitter reference output																												
Jitter measurement	Conforms to ITU-T O.172 Frequency: 2488.32 MHz ± 100 ppm Modulation frequency: 10 Hz to 20 MHz Amplitude: 0.0 to 32 UI Resolution: 0.001 Ulp-p/0.001 UIrms (2 UI range), 0.01 Ulp-p/0.01 UIrms (32 UI range) <table border="1" data-bbox="922 1724 1441 1835"> <thead> <tr> <th>Bit rate (Mbit/s)</th> <th>F0 (Hz)</th> <th>F0' (Hz)</th> <th>F2' (kHz)</th> <th>F2'' (kHz)</th> <th>F3' (MHz)</th> <th>F4 (MHz)</th> </tr> </thead> <tbody> <tr> <td rowspan="2">2488.32</td> <td>2 UI</td> <td>-</td> <td>100</td> <td>-</td> <td>100</td> <td>1</td> </tr> <tr> <td>32 UI</td> <td>10</td> <td>-</td> <td>6.25</td> <td>-</td> <td>1</td> </tr> </tbody> </table>	Bit rate (Mbit/s)	F0 (Hz)	F0' (Hz)	F2' (kHz)	F2'' (kHz)	F3' (MHz)	F4 (MHz)	2488.32	2 UI	-	100	-	100	1	32 UI	10	-	6.25	-	1								
Bit rate (Mbit/s)	F0 (Hz)	F0' (Hz)	F2' (kHz)	F2'' (kHz)	F3' (MHz)	F4 (MHz)																							
2488.32	2 UI	-	100	-	100	1																							
	32 UI	10	-	6.25	-	1																							

Continued on next page

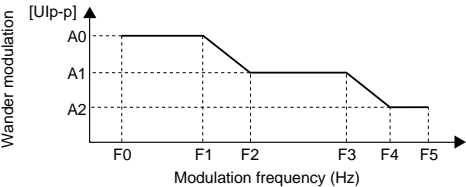
<p>Jitter measurement</p>	<p>Conforms to ITU-T O.172 LP, HP0 + LP, HP1 + LP, HP2 + LP, HP + LP</p> <table border="1" data-bbox="395 205 788 285"> <thead> <tr> <th>Bit rate (Mbit/s)</th> <th>HP0 (Hz)</th> <th>HP1 (Hz)</th> <th>HP2 (Hz)</th> <th>HP (Hz)</th> <th>LP (Hz)</th> </tr> </thead> <tbody> <tr> <td>2488.32</td> <td>10</td> <td>5k</td> <td>1M</td> <td>12k</td> <td>20M</td> </tr> </tbody> </table> <p>Accuracy (Ulp-p, UI+p, UI-p) 2 UI range: Measurement value $\pm R\% \pm W$ Ulp-p, 32 UI range: Measurement value $\pm R\% \pm W$ Ulp-p [MU150008A/150009A/150010A are simultaneously installed, conform to ITU-T O.172]</p> <p>Fixed error [W] Input level: -12 to -10 dBm (adds to 0.01 Ulp-p/dB at <-12 dBm)</p> <table border="1" data-bbox="395 415 879 537"> <thead> <tr> <th rowspan="3">Bit rate (Mbit/s)</th> <th colspan="5">SONET/SDH signal</th> </tr> <tr> <th colspan="2">HP1 + LP</th> <th colspan="2">HP2 + LP</th> <th rowspan="2">Container</th> </tr> <tr> <th>2 UI</th> <th>32 UI</th> <th>2 UI</th> <th>32 UI</th> </tr> </thead> <tbody> <tr> <td>2488.32</td> <td>0.100</td> <td>2.2</td> <td>0.050</td> <td>1.40</td> <td>VC4-16c</td> </tr> </tbody> </table> <p style="text-align: center;">At PRBS 2²³ - 1</p> <table border="1" data-bbox="919 415 1313 537"> <thead> <tr> <th rowspan="3">Bit rate (Mbit/s)</th> <th colspan="4">Clock signal</th> </tr> <tr> <th colspan="2">HP1 + LP</th> <th colspan="2">HP2 + LP</th> </tr> <tr> <th>2 UI</th> <th>32 UI</th> <th>2 UI</th> <th>32 UI</th> </tr> </thead> <tbody> <tr> <td>2488.32</td> <td>0.050</td> <td>0.60</td> <td>0.030</td> <td>0.50</td> </tr> </tbody> </table> <p>Accuracy (Ulrms) 2 UI range: $\pm R\% \pm Y$ Ulrms, 32 UI range: $\pm R\% \pm Y$ Ulrms</p> <p>Fixed error [Y] Input level: -12 to -10 dBm (adds to 0.002 Ulrms/dB at <-12 dBm)</p> <table border="1" data-bbox="395 674 879 798"> <thead> <tr> <th rowspan="3">Bit rate (Mbit/s)</th> <th colspan="3">SONET/SDH signal</th> <th colspan="2">Clock signal</th> </tr> <tr> <th colspan="2">HP + LP</th> <th rowspan="2">Container</th> <th colspan="2">HP + LP</th> </tr> <tr> <th>2 UI</th> <th>32 UI</th> <th>2 UI</th> <th>32 UI</th> </tr> </thead> <tbody> <tr> <td>2488.32</td> <td>0.012</td> <td>0.08</td> <td>VC4-16c</td> <td>0.010</td> <td>0.16</td> </tr> </tbody> </table> <p style="text-align: center;">At PRBS 2²³ - 1</p> <p>Frequency error [R]</p> <table border="1" data-bbox="395 856 772 1041"> <thead> <tr> <th>Frequency error</th> <th>Frequency range</th> </tr> </thead> <tbody> <tr> <td>$\pm 7\%$</td> <td>5 to 300 kHz</td> </tr> <tr> <td>$\pm 8\%$</td> <td>300 kHz to 1 MHz</td> </tr> <tr> <td>$\pm 10\%$</td> <td>1 to 3 MHz</td> </tr> <tr> <td>$\pm 15\%$</td> <td>3 to 10 MHz</td> </tr> <tr> <td>$\pm 20\%$</td> <td>10 to 20 MHz</td> </tr> </tbody> </table>	Bit rate (Mbit/s)	HP0 (Hz)	HP1 (Hz)	HP2 (Hz)	HP (Hz)	LP (Hz)	2488.32	10	5k	1M	12k	20M	Bit rate (Mbit/s)	SONET/SDH signal					HP1 + LP		HP2 + LP		Container	2 UI	32 UI	2 UI	32 UI	2488.32	0.100	2.2	0.050	1.40	VC4-16c	Bit rate (Mbit/s)	Clock signal				HP1 + LP		HP2 + LP		2 UI	32 UI	2 UI	32 UI	2488.32	0.050	0.60	0.030	0.50	Bit rate (Mbit/s)	SONET/SDH signal			Clock signal		HP + LP		Container	HP + LP		2 UI	32 UI	2 UI	32 UI	2488.32	0.012	0.08	VC4-16c	0.010	0.16	Frequency error	Frequency range	$\pm 7\%$	5 to 300 kHz	$\pm 8\%$	300 kHz to 1 MHz	$\pm 10\%$	1 to 3 MHz	$\pm 15\%$	3 to 10 MHz	$\pm 20\%$	10 to 20 MHz
Bit rate (Mbit/s)	HP0 (Hz)	HP1 (Hz)	HP2 (Hz)	HP (Hz)	LP (Hz)																																																																																
2488.32	10	5k	1M	12k	20M																																																																																
Bit rate (Mbit/s)	SONET/SDH signal																																																																																				
	HP1 + LP		HP2 + LP		Container																																																																																
	2 UI	32 UI	2 UI	32 UI																																																																																	
2488.32	0.100	2.2	0.050	1.40	VC4-16c																																																																																
Bit rate (Mbit/s)	Clock signal																																																																																				
	HP1 + LP		HP2 + LP																																																																																		
	2 UI	32 UI	2 UI	32 UI																																																																																	
2488.32	0.050	0.60	0.030	0.50																																																																																	
Bit rate (Mbit/s)	SONET/SDH signal			Clock signal																																																																																	
	HP + LP		Container	HP + LP																																																																																	
	2 UI	32 UI		2 UI	32 UI																																																																																
2488.32	0.012	0.08	VC4-16c	0.010	0.16																																																																																
Frequency error	Frequency range																																																																																				
$\pm 7\%$	5 to 300 kHz																																																																																				
$\pm 8\%$	300 kHz to 1 MHz																																																																																				
$\pm 10\%$	1 to 3 MHz																																																																																				
$\pm 15\%$	3 to 10 MHz																																																																																				
$\pm 20\%$	10 to 20 MHz																																																																																				
Hit measurement	Count, Seconds, % free seconds																																																																																				
Frequency measurement	Resolution: 0.1 ppm, Display: Hz or ppm (after power-on, calibrates after 60 min warm-up, 23° $\pm 5^\circ$ C)																																																																																				
Auxiliary interface	Reference clock input																																																																																				
Auto jitter measurement	<p>Jitter tolerance measurement: Evaluates jitter tolerance point automatically</p> <p>Jitter sweep measurement: Conforms to high-speed jitter tolerance evaluation for mass production, etc.</p> <p>Jitter transfer measurement: High dynamic range measurement by selective level method</p> <p>Frequency sweep measurement: Measures the jitter tolerance automatically while changing the offset</p>																																																																																				
Line wander generation	<p>Modulation frequency: 10 μHz to 0.2 Hz (sine wave) Amplitude: 0 to 57,600 Ulp-p (30 Ulp-p steps)</p>  <table border="1" data-bbox="395 1486 1031 1579"> <thead> <tr> <th rowspan="2">Bit rate (Mbit/s)</th> <th colspan="3">Amplitude (Ulp-p)</th> <th colspan="6">Frequency (Hz)</th> </tr> <tr> <th>A0</th> <th>A1</th> <th>A2</th> <th>f0</th> <th>f1</th> <th>f2</th> <th>f3</th> <th>f4</th> <th>f5</th> </tr> </thead> <tbody> <tr> <td>2488.32</td> <td>57600</td> <td>6480</td> <td>810</td> <td>10μ</td> <td>180μ</td> <td>1.6m</td> <td>16m</td> <td>0.13</td> <td>0.2</td> </tr> </tbody> </table> <p>Accuracy: $\pm Q\% \pm 160$ Ulp-p</p> <table border="1" data-bbox="395 1612 772 1705"> <thead> <tr> <th>Frequency error</th> <th>Frequency range</th> </tr> </thead> <tbody> <tr> <td>$\pm 8\%$</td> <td>10 μHz to 0.1 Hz</td> </tr> <tr> <td>$\pm 12\%$</td> <td>0.1 to 0.2 Hz</td> </tr> </tbody> </table>	Bit rate (Mbit/s)	Amplitude (Ulp-p)			Frequency (Hz)						A0	A1	A2	f0	f1	f2	f3	f4	f5	2488.32	57600	6480	810	10 μ	180 μ	1.6m	16m	0.13	0.2	Frequency error	Frequency range	$\pm 8\%$	10 μ Hz to 0.1 Hz	$\pm 12\%$	0.1 to 0.2 Hz																																																	
Bit rate (Mbit/s)	Amplitude (Ulp-p)			Frequency (Hz)																																																																																	
	A0	A1	A2	f0	f1	f2	f3	f4	f5																																																																												
2488.32	57600	6480	810	10 μ	180 μ	1.6m	16m	0.13	0.2																																																																												
Frequency error	Frequency range																																																																																				
$\pm 8\%$	10 μ Hz to 0.1 Hz																																																																																				
$\pm 12\%$	0.1 to 0.2 Hz																																																																																				
Auto wander measurement	Wander sweep measurement																																																																																				
Reference wander generation	<p>Reference wander generation is valid when MU150005A/150006A/150007A Option 03 is mounted.</p> <p>Off: Able to set non-modulated status</p> <p>TDEV mask: The 37 types of TDEV masks that are regulated by ITU-T, ETSI, ANSI, and Bellcore standards are available as default. It is possible to add the wander modulation to the user specified TDEV mask. Transient: It is possible to change the A (1 - e^{-63.7t}) phase by the timing of the start. Signal off: It is possible to disconnect the standard signal.</p>																																																																																				

Continued on next page

Wander measurement	<p>Wander measurement is valid when MU150005A/150006A/150007A Option 02 is mounted. Conforms to ITU-T O.172</p> <p>Reference input: 2.048M (HDB3, clock), 1.544M (AMI/B8ZS, clock), 64k + 8 kHz, 5 MHz, 10 MHz</p> <p>Sampling frequency: 320 Hz, 40 Hz, 1 Hz, 0.1 Hz, 5 mHz (select from MX150001B)</p> <p>Measurement range</p> <p>P-P: 0.0 to 2E10 ns, +P/-P: 0.0 to 1E10 ns, TIE: 0.0 to ±1E10 ns</p> <p>Accuracy: Conform to ITU-T O.172</p> <p>Measurement time: 10 to 1 x 10⁸ s (Max. 120,000 s: MP1570A only)</p> <p>Wander application (requires MX150001B Wander Application Software)</p> <p>TIE: Max. 1 x 10⁸ s</p> <p>MTIE: Max. 1 x 10⁸ s</p> <p>TDEV: Max. 1 x 10⁶ s</p> <p>Frequency offset: Measurement with conform to ANSI T1.105.09</p> <p>Frequency drift rate: Measurement with conform to ANSI T1.105.09</p> <p>MRTIE: Evaluation separated from the wander by the frequency variation</p> <p>Wander tolerance (TDEV) measurement: Evaluation by the various TDEV mask generations</p> <p>Wander transfer (TDEV) measurement: Calibration method by simulation, outputting results by the one measurement</p>
--------------------	--

• **MP0123A ATM Unit**

Bit rate	1.544, 2.048, 34.368, 44.736, 139.264, 51.84, 155.52, 622.08 Mbit/s
Mapping	<p>The diagram illustrates the mapping of various input rates to SDH/SONET and PDH/DSn standards, which are then mapped to ATM/AAL services. On the left, input rates include STM-4c/OC-12c (optical), STM-1c/OC-3c (optical), STM-1c/STS-3c, STM-0/STS-1, 139M (G.832), 34M (G.832), 2M (G.704), 45M (G.704), and 1.5M (G.704). These connect to SDH/SONET and PDH/DSn. SDH/SONET and PDH/DSn then connect to ATM/AAL services: AAL1, AAL2, AAL3/4, AAL5, and ATM.</p>
Traffic pattern	CBR, burst, sawtooth, CBR/PCR with CDV, Poisson
Test patterns	<p>Cell: Single cell PRBS 9, cross cell PRBS 9/15/23, 16-bit word pattern, edit pattern, time stamp</p> <p>O.191: Edit pattern</p> <p>AAL1: Single cell PRBS 9, cross cell PRBS 9/15/23, 16-bit word pattern, edit pattern, time stamp</p> <p>AAL2 (CPS-PDU): Time stamp</p> <p>AAL2 (CPS-PACKET): Single cell PRBS 7, 8-bit word pattern, edit pattern</p> <p>AAL3/4 (SAR-PDU): Time stamp</p> <p>AAL3/4 (CPCS-PDU): Single cell PRBS 9, cross cell PRBS 9/15/23, 16-bit word pattern, edit pattern</p> <p>AAL5: Single cell PRBS 9, cross cell PRBS 9/15/23, 16-bit word pattern, edit pattern</p>
Error addition	<p>Cell: HEC, programmable pattern</p> <p>O.191: Lost cell, misinserted cell, errored cell, SECB</p> <p>AAL1: Lost cell, SNP, PRBS, word</p> <p>AAL2 (CPS-PDU): P, SN, OSF</p> <p>AAL2 (CPS-PACKET): HEC, PRBS, word</p> <p>AAL3/4 (SAR-PDU): SN, CRC10, segment type, LI, abort</p> <p>AAL3/4 (CPCS-PDU): CPI, B/E tag mismatch, BA size, AL, length, PRBS, word</p> <p>AAL5: Frame size, length, CRC32, abort, PRBS, word</p>
Alarm addition	LCD, VP/VC AIS, VP/VC RDI, VP/VC CC, VP/VC loopback cell
PM cell	Error insertion: Lost cell, misinserted cell, BIPV, SECB
Cell editing	O.191, AAL1, AAL2, AAL3/4, AAL5, AIS, RDI, CC, loopback, FM, BR, background (10 ch)
Memorized cell	Possible to send after editing receiver's capture data
Measurement	<p>Mode: Single, repeat, manual</p> <p>Error</p> <p>Cell: Cell count, correctable HEC, uncorrectable HEC, non-conforming cell</p> <p>O.191: Errored cell, lost cell, misinserted cell, SECB</p> <p>AAL1: SAR-PDU count, lost cell, SNP, uncorrectable SNP, PRBS, word</p> <p>AAL2: CPS-PDU count, P, OSF, SN, CPS packet count, CID count, HEC, PRBS, word</p> <p>AAL3/4*: SAR-PDU count, CRC10, MID count (SAR-PDU with selected MID value), SN, ST (segment type), LI, abort, discarded PDU (one of SN error, LI error, abort, COM with ST error, or EOM with ST error), CPCS-PDU count, CPI, B/E tag mismatch, BA size, AL, length, undelivered PDU (one of CPI error, B/E tag mismatch, BA size error, AL error, or length error), PRBS, word</p> <p>*CRC10 is calculated for all SAR-PDU. The others are calculated for SAR-PDU with specified MID.</p> <p>AAL5: CPCS-PDU count, frame size, length, CRC32, abort, discarded PDU (one of frame size error, length error, CRC32 error, or abort), PRBS, word</p> <p>FM: Lost cell, misinserted cell, BIPV, SECB</p> <p>BR: Lost cell, misinserted cell, BIPV, SECB</p> <p>Alarm: LCD, VP/VC segment AIS, VP/VC end-to-end AIS, VP/VC segment RDI, VP/VC end-to-end RDI, VP/VC segment LOC, VP/VC end-to-end LOC</p>
LED	LCD, VP-AIS, VP-RDI, VP-LOC, VC-AIS, VC-RDI, VC-LOC, errors
Monitor	Live monitor (1023 channel monitor), traffic monitor, cell monitor
Delay measurement	1-point CDV, 2-point CDV
Capture	1 to 2016 cells

• MP0131A Add/Drop Unit

Bit rate	1.544, 2.048, 34.368, 44.736, 139.264 Mbit/s
Level/waveform	1.544 Mbit/s: ANSI T1.102, 0/655 ft 44.736 Mbit/s: ANSI T1.102, 0/450/900 ft (0 ft: Drop only) 2.048/34.368/139 Mbit/s: ITU-T G.703
Connector	BANTAM (100 Ω, balanced): 1.544 Mbit/s (AMI/B8ZS) 3-pin Siemens (120 Ω, balanced): 2.048 Mbit/s (HDB3) BNC (75 Ω, unbalanced): 2.048 Mbit/s, 34.368 Mbit/s (HDB3), 139.264 Mbit/s (CMI)
Mapping	See Fig. 3 and 4

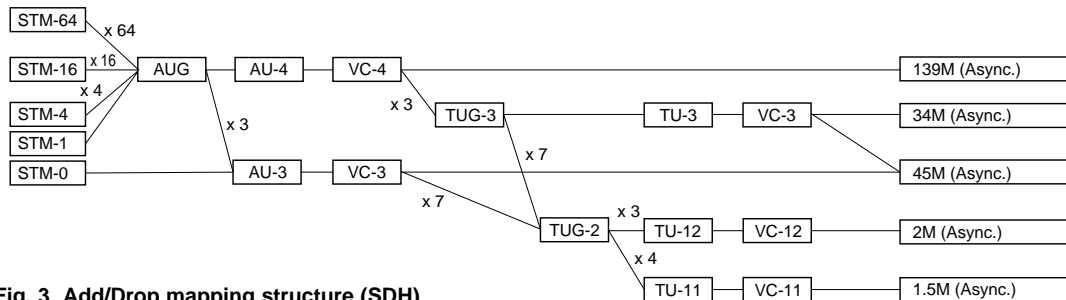

Fig. 3 Add/Drop mapping structure (SDH)

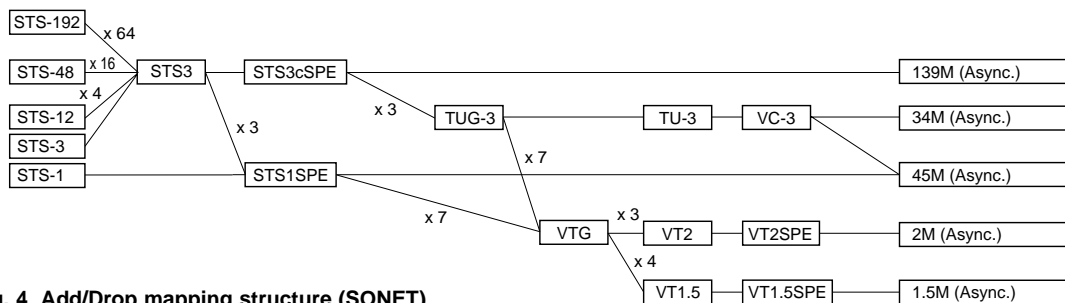

Fig. 4 Add/Drop mapping structure (SONET)

• MP0111A Optical 156M/622M (1.31) Unit

Transmit	Bit rate: 155.52, 622.08 Mbit/s (NRZ) Wavelength: 1310 nm Output level: -11.5 dBm ±3.5 dB Optical safety: IEC 825-1 Class 1, 21CFR1040.10 Class I Connector: FC-PC (SM-F)
Receive	Bit rate: 155.52, 622.08 Mbit/s (NRZ) Sensitivity 156M: -33 to -8 dBm (test pattern: PRBS 2 ²³ - 1, BER 10 ⁻¹⁰ , +10° to +40°C) 622M: -28 to -8 dBm (test pattern: PRBS 2 ²³ - 1, BER 10 ⁻¹⁰ , +10° to +40°C) Connector: FC-PC (SM-F) Power measurement Measurement range: -30 to 0 dBm (peak power) Accuracy: ≤±1 dB (-20 dBm) Linearity: ≤±1 dB (-30 to 0 dBm)

• MP0113A Optical 156M/622M (1.31/1.55) Unit

Transmit	Bit rate: 155.52, 622.08 Mbit/s (NRZ) Wavelength: 1310/1550 nm Output level 1.31 μm: -11.5 dBm ±3.5 dB, 1.55 μm: -5 dBm ±2 dB Optical safety: IEC825-1 Class 1, 21CFR1040.10 Class I Connector: FC-PC (SM-F)
Receive	Bit rate: 155.52, 622.08 Mbit/s (NRZ) Sensitivity 156M: -33 to -8 dBm (test pattern: PRBS 2 ²³ - 1, BER 10 ⁻¹⁰ , +10° to +40°C) 622M: -28 to -8 dBm (test pattern: PRBS 2 ²³ - 1, BER 10 ⁻¹⁰ , +10° to +40°C) Connector: FC-PC (SM-F) Power measurement Measurement range: -30 to 0 dBm (peak power) Accuracy: ≤±1 dB (-20 dBm) Linearity: ≤±1 dB (-30 to 0 dBm)

• MP0112A Optical 156M/622M (1.55) Unit

Transmit	Bit rate: 155.52, 622.08 Mbit/s (NRZ) Wavelength: 1550 nm Output level: -5 dBm ±2 dB Optical safety: IEC825-1 Class 1, 21CFR1040.10 Class I Connector: FC-PC (SM-F)
Receive	Bit rate: 155.52, 622.08 Mbit/s (NRZ) Sensitivity 156M: -33 to -8 dBm (test pattern: PRBS 2 ²³ - 1, BER 10 ⁻¹⁰ , +10° to +40°C) 622M: -28 to -8 dBm (test pattern: PRBS 2 ²³ - 1, BER 10 ⁻¹⁰ , +10° to +40°C) Connector: FC-PC (SM-F) Power measurement Measurement range: -30 to 0 dBm (peak power) Accuracy: ≤±1 dB (-20 dBm) Linearity: ≤±1 dB (-30 to 0 dBm)

• MP0105A CMI Unit

Transmit	Bit rate: 155.52 Mbit/s, Level: 1 ±0.1 V, Connector: BNC (75 Ω)
Receive	Bit rate: 155.52 Mbit/s Level: 1 ±0.1 V (0 to 12 dB, with √F auto correction and monitor function) Connector: BNC (75 Ω)

• MP0108A NRZ Unit

Transmit	Bit rate: 155.52, 622.08 Mbit/s Level: ECL Connector (data, clock): SMA (50 Ω)
Receive	Bit rate: 155.52, 622.08 Mbit/s Level: ECL (-2 V) Connector (data, clock): SMA (50 Ω)

• **MU0122B 1.5/45/52/52 (1.31) Unit**

Optical interface

Transmit	Bit rate: 51.84 Mbit/s (NRZ) Wavelength: 1310 nm Output level: -11.5 dBm ±3.5 dB Optical safety: IEC 825-1 Class 1, 21CFR1040.10 Class I Connector: FC-PC (SM-F)
Receive	Bit rate: 51.84 Mbit/s (NRZ) Sensitivity 52M: -33 to -8 dBm (test pattern: PRBS 2 ²³ - 1, BER 10 ⁻¹⁰ , +10° to +40°C) Connector: FC-PC (SM-F) Power measurement Measurement range: -30 to 0 dBm (peak power) Accuracy: ≤±1 dB (-20 dBm) Linearity: ≤±1 dB (-30 to 0 dBm) Monitor input Level: 0.1 to 1.0 Vp-p (AC), Connector: SMA (50 Ω)

• **MU150008A/150009A/150010A 2.5G Unit**

Bit rate	2488.32 Mbit/s (NRZ)
Optical output	Wavelength: 1310 nm (MU150008A), 1550 nm (MU150009A), 1310/1550 nm (MU150010A) Output level: -4 dBm ±3 dB Optical safety: IEC825-1 Class 3A, 21CFR1040.10 Class IIIb Connector: FC-PC (SM-F)
Optical input	Sensitivity Narrow: -28 to -9 dBm (BER 10 ⁻¹⁰ , +10° to +30°C), -27 to -9 dBm (BER 10 ⁻¹⁰ , 0° to +30°C) Wide: -20 to -9 dBm (BER 10 ⁻¹⁰ , +10° to +40°C) Connector: FC-PC (SM-F) Power measurement Range: -30 to -9 dBm (peak power) Accuracy: ≤±2 dB (-20 dBm) Linearity: ≤±2 dB (-30 to -9 dBm)
Electrical I/O	Transmit (NRZ) Level: ECL (-2 V), Connector (data, clock): SMA (50 Ω) Receive (NRZ) Level: ECL (-2 V), Connector (data, clock): SMA (50 Ω) Monitor input Level: 0.1 to 1.0 Vp-p (AC), Connector (data): SMA (50 Ω)
Auxiliary interface	External clock input, receive clock output, sync. output

• **MU150000A 2.5G/10G Unit**

Bit rate	9953.28, 2488.32 Mbit/s (NRZ)
Electrical I/O	Transmit (NRZ) Level Data H: 0 to -0.2 V, Data L: -0.85 to -1.4 V Clock H: 0 to -0.2 V, Clock L: -0.85 to -1.3 V Connector (data, clock): SMA (50 Ω) Receive (NRZ) Level Data: 0.65 to 1.4 Vp-p, Clock: 0.65 to 1.3 Vp-p Connector (data, clock): SMA (50 Ω)
Auxiliary interface	External clock input, internal clock output, receive clock output, 156M sync. output

• **MU150001A/B Optical 10G Tx (1.55) Unit**

Bit rate	9953.28, 2488.32 Mbit/s (Option)
Optical output	Wavelength: 10G: 1550 nm band 2.5G: 1310 nm band (Option 01), 1550 nm band (Option 02), 1310/1550 nm band (Option 03) Output level: -4 dBm ±3 dB Optical safety: IEC825-1 Class 3A, 21CFR1040.10 Class IIIb Connector: FC-PC (SMF)
Electrical input	Data input H: 0 to -0.2 V, L: -0.85 to -1.4 V Clock input H: 0 to -0.2 V, L: -0.85 to -1.3 V Connector: SMA 50 Ω

• **MU150002A Optical 10G Rx (Narrow) Unit**

Bit rate	9953.28, 2488.32 Mbit/s (Option 01)
Optical input	Sensitivity 10G: -13 to -3 dBm (BER 10 ⁻¹² , NRZ, mark ratio: 1/2, PRBS: 2 ³¹ - 1) 2.5G: -29 to -10 dBm (BER 10 ⁻¹¹ , NRZ, mark ratio: 1/2, PRBS: 2 ²³ - 1) (Option 01) Connector: FC-PC (SMF) Power measurement Range: -16 to 0 dBm (10G, average power), -30 to -10 dBm (2.5G, average power) Accuracy: ≤±2 dB (10G, -10 dBm), ≤±2 dB (2.5G, -20 dBm) Linearity: ≤±2 dB (10G, -16 to 0 dBm), ≤±2 dB (2.5G, -30 to -10 dBm)
Electrical output	Data output: 0.65 to 1.4 Vp-p Clock output: 0.65 to 1.3 Vp-p Connector: SMA 50 Ω

• **MU150031A/C Optical 10G Tx (1.55) High Power Unit**

Bit rate	MU150031A: 9953.28 Mbit/s MU150031C: 9953.28 Mbit/s, 2488.32 Mbit/s
Optical output	Wavelength: 1525 to 1565 nm Output level: +2 dBm ±2 dB Optical Safety: IEC825-1 (Class 3A), 21CFR1040.10 (Class IIIb) Connector: FC-PC (SM-F)
Electrical input	Data input H: 0 to -0.2 V, L: -0.85 to -1.4 V Clock input H: 0 to -0.2 V, L: -0.85 to -1.3 V Connector: SMA (50 Ω)

• **MU150061A/B Optical 10G Tx (1.31) Unit**

Bit rate	MU150061A: 9953.28 Mbit/s MU150061B: 9953.28 Mbit/s, 2488.32 Mbit/s
Optical output	Wavelength: 1290 to 1330 nm Output level: +3 dBm ±2 dB Optical Safety: IEC825-1 (Class 3A), 21CFR1040.10 (Class IIIb) Connector: FC-PC (SM-F)
Electrical input	Data input H: 0 to -0.2 V, L: -0.85 to -1.4 V Clock input H: 0 to -0.2 V, L: -0.85 to -1.3 V Connector: SMA (50 Ω)

• **MU150017A/B Optical 10G Rx (Wide) Unit**

Bit rate	MU150017A: 9953.28 Mbit/s ±100 ppm MU150017B: 9953.28 Mbit/s ±100 ppm, 2488.32 Mbit/s ±100 ppm
Optical output	Wavelength 10G: 1550 nm band, 2.5G: 1310/1550 nm band (MU150017B) Sensitivity: -11 to -3 dBm (10G BER10 ⁻¹² , NRZ, VC4-64c, scramble: on, mark ratio: 1/2, PRBS 2 ²³ - 1) -15 to -3 dBm (2.5G BER10 ⁻¹² , NRZ, VC4-16c, scramble: on, mark ratio: 1/2, PRBS 2 ²³ - 1) Connector: FC-SPC (SM-F) Power measurement Range: -16 to -2 dBm (10G, average power), -36 to -2 dBm (2.5G average power) Accuracy: ≤±2 dB
Electrical input	Data output: 0.7 to 1.3 Vp-p Clock output: 0.65 to 1.3 Vp-p Connector: SMA (50 Ω) Output phase: Variable output clock phase according to output data (10G only)

Unit	Slot 1	Slot 2	Slot 3	Slot 4/5	Front
MP0121A 2/8/34/139/156M Unit	√				
MP0122A 1.5/45/52M Unit	√*	√			
MP0122B 1.5/45/52/52M (1.31) Unit	√*	√			
MP0123A ATM Unit			√		
MU150005A 2/8/34/139M, 156/622M Jitter Unit				√	
MU150006A 1.5/45/52M, 156/622M Jitter Unit				√	
MU150007A 2/8/34/139M, 1.5/45/52M, 156M/622M Jitter Unit				√	
MP0111A Optical 156/622M (1.31) Unit					√
MP0112A Optical 156/622M (1.55) Unit					√
MP0113A Optical 156/622M (1.31/1.55) Unit					√
MU150008A 2.5G (1.31) Unit		√			
MU150009A 2.5G (1.55) Unit		√			
MU150010A 2.5G (1.31/1.55) Unit		√			
MU150011A 2.5G Jitter Unit			√		
MP0131A Add/Drop Unit	√	√			
MU150000A 2.5G/10G Unit				√	
MU150001A/B Optical 10G Tx (1.55) Unit			√		
MU150002A Optical 10G Rx (Narrow) Unit		√			
MP0105A CMI Unit					√
MP0108A NRZ Unit					√
MU150031A/C Optical 10G Tx (1.55) High Power Unit			√		
MU150061A/B Optical 10G Tx (1.31) Unit			√		
MU150017A/B Optical 10G Rx (Wide) Unit		√			

Note: The same model name units can not be used simultaneously with inserted them in to the plural slots. Only one unit is usable at a time.

*: MP0122A/B can not insert in to slot 1 when MP0123A is inserted in to Slot 3

Ordering information

Please specify model/order number name and quantity when ordering.

Model/Order No.	Name
	Main frame
MP1570A*1	SONET/SDH/PDH/ATM Analyzer
	Standard accessories
	AC power cord: 1 pc
Z0169	Printer paper (5 rolls/pack): 1 pack
F0079	Fuse, 10 A: 2 pcs
B0329G	Front cover: 1 pc
Z0486	Side cover: 1 pc
J0907Q	Remote interlock cord (for MU150001A/B, MU150008A, MU150009A, MU150010A, MU150031A/C, MU150061A/B): 1 pc
J0908	Remote interlock terminator (for MU150001A/B, MU150008A, MU150009A, MU150010A, MU150031A/C, MU150061A/B): 1 pc
E0008A	Optical output control key (for MU150001A/B, MU150008A, MU150009A, MU150010A, MU150031A/C, MU150061A/B): 2 pcs
J0747A	Fixed optical attenuator (5 dB, for MU150017A/B): 1 pc
J0747B	Fixed optical attenuator (10 dB, for MU150002A): 1 pc
J0900A	Coaxial cable (AA-165-200), 20 cm (for MU150011A): 2 pcs
J0635A	Optical fiber cable (FC · PC-FC · PC), 1 m (for MU150002A, MU150008A, MU150009A, MU150010A, MU150017A/B): 1 pc
MX150001B	Wander (MTIE, TDEV) Measurement Application Software (supplied with MU150005A-02, MU150006A-02, MU150007A-02): 1 pc
W1719AE	MP1570A operation manual (Vol. 1 Basic operation for SDH): 1 copy
W1720AE	MP1570A operation manual (Vol. 1 Basic operation for SONET): 1 copy
W1721AE	MP1570A operation manual (Vol. 2 Remote control): 1 copy
W1722AE	MP1570A operation manual (Vol. 3 ATM measurement): 1 copy
W1723AE	MP1570A operation manual (Vol. 4 2.5G/10G measurement): 1 copy
W1724AE	MP1570A operation manual (Vol. 5 Add/Drop function): 1 copy
W1725AE	MP1570A operation manual (Vol. 6 Jitter/wander measurement, for MU150005A/150006A/150007A): 1 copy
W1726AE	MP1570A operation manual (Vol. 7 2.5G jitter/wander measurement, for MU150011A): 1 copy
W1763AE	Wander (MTIE, TDEV) APPLI SOFT manual (supplied with MX150001B): 1 copy
J1002A	Semi-rigid cable (for MU150001A/B, MU150031A/C, MU150061A/B): 2 pcs
J1002B	Semi-rigid cable (for MU150002A, MU150017A/B): 2 pcs
J1002C	Semi-rigid cable (for MU150000A): 3 pcs
	Plug-in units
MP0121A	2/8/34/139/156M Unit
MP0122A	1.5/45/52M Unit
MP0122B*2	1.5/45/52/52M (1.31) Unit
MP0123A	ATM Unit
MU150008A*2	2.5G (1.31) Unit (with optical power meter)
MU150009A*2	2.5G (1.55) Unit (with optical power meter)
MU150010A*2	2.5G (1.31/1.55) Unit (with optical power meter)
MP0131A	Add/Drop Unit
MU150000A	2.5G/10G Unit
MU150001A*2	Optical 10G Tx (1.55) Unit (2 km transmission)
MU150001B*2	Optical 10G Tx (1.55) Unit (40 km transmission)
MU150002A*2	Optical 10G Rx (Narrow) Unit (with optical power meter)
MP0111A*2	Optical 156M/622M (1.31) Unit (with optical power meter)
MP0112A*2	Optical 156M/622M (1.55) Unit (with optical power meter)
MP0113A*2	Optical 156M/622M (1.31/1.55) Unit (with optical power meter, 1.31/1.55 switchable)
MU150017A	Optical 10G Rx (Wide) Unit
MU150017B	Optical 2.5G/10G Rx (Wide) Unit
MU150031A	Optical 10G Tx (1.55) High Power Unit
MU150031C	Optical 2.5G/10G Tx (1.55) High Power Unit
MU150061A	Optical 10G Tx (1.31) Unit

Continued on next page

Model/Order No.	Name
MU150061B	Optical 2.5G/10G Tx (1.31) Unit
MU150005A	2/8/34/139M, 156/622M Jitter Unit [jitter generation/ measurement only (requires MP0121A)]
MU150006A	1.5/45/52M, 156/622M Jitter Unit [jitter generation/ measurement only (requires MP0122A/B)]
MU150007A	2/8/34/139M, 1.5/45/52M, 156/622M Jitter Unit [jitter generation/measurement only (requires MP0121A or MP0122A/B)]
MU150011A	2.5G Jitter Unit [jitter generation/measurement only (requires MU150008A/150009A or MU150010A)]
MP0105A	CMI Unit
MP0108A	NRZ Unit
	Options
MP1570A-01*3	RS-232C
MP1570A-02*3	GPIB
MP1570A-03*3	Ethernet
MP1570A-04*3	VGA output
MP1570A-06	MUX/DEMUX (2/8/34/139 Mbit/s, for MP0121A)
MP1570A-07	MUX/DEMUX (1.5/45 Mbit/s, for MP0122A/B)
MP1570A-08	45M-2M MUX/DEMUX (requires MP0121A and MP0122A/B)
MP1570A-09	Japan mapping (requires MP0122A or MP0122B)
MP1570A-10*1	SDH
MP1570A-11*1	SONET
MP1570A-13	Frame memory capture (156M/622M, 64 frame)
MP1570A-14	IP-over-SONET/SDH (requires MP1570A-13)
MP1570A-15	IP-over-ATM (requires MP0123A)
MP1570A-22	K1/K2 overwrite through
MU150005A-02	Wander measurement
MU150006A-02	Wander measurement
MU150007A-02	Wander measurement
MU150005A-03	Wander reference output
MU150006A-03	Wander reference output
MU150007A-03	Wander reference output
MU150008A-01	Frame memory capture (2.5G, 64 frame)
MU150009A-01	Frame memory capture (2.5G, 64 frame)
MU150010A-01	Frame memory capture (2.5G, 64 frame)
MU150000A-01	Frame memory capture (2.5G/10G, 26 frame)
MU150001A/B-01	2.5G (1.31)
MU150001A/B-02	2.5G (1.55)
MU150001A/B-03	2.5G (1.31/1.55)
MU150002A-01	2.5G
MU150002A-04	Available for 10G (1.31)
MP0111A/0112A-37	FC connector (replaceable, 2 sets)
MP0111A/0112A-38	ST connector (replaceable, 2 sets)
MP0111A/0112A-39	DIN connector (replaceable, 2 sets)
MP0111A/0112A-40	SC connector (replaceable, 2 sets)
MP0111A/0112A-43	HMS-10/A connector (replaceable, 2 sets)
MP0113A-37	FC connector (replaceable, 3 sets)
MP0113A-38	ST connector (replaceable, 3 sets)
MP0113A-39	DIN connector (replaceable, 3 sets)
MP0113A-40	SC connector (replaceable, 3 sets)
MP0113A-43	HMS-10/A connector (replaceable, 3 sets)
MP0122B-37	FC connector (replaceable, 2 sets)
MP0122B-38	ST connector (replaceable, 2 sets)
MP0122B-39	DIN connector (replaceable, 2 sets)
MP0122B-40	SC connector (replaceable, 2 sets)
MP0122B-43	HMS-10/A connector (replaceable, 2 sets)
MU150008A-37	FC connector (replaceable, 2 sets)
MU150008A-38	ST connector (replaceable, 2 sets)
MU150008A-39	DIN connector (replaceable, 2 sets)
MU150008A-40	SC connector (replaceable, 2 sets)

Model/Order No.	Name
MU150008A-43	HMS-10/A connector (replaceable, 2 sets)
MU150009A-37	FC connector (replaceable, 2 sets)
MU150009A-38	ST connector (replaceable, 2 sets)
MU150009A-39	DIN connector (replaceable, 2 sets)
MU150009A-40	SC connector (replaceable, 2 sets)
MU150009A-43	HMS-10/A connector (replaceable, 3 sets)
MU150010A-37	FC connector (replaceable, 3 sets)
MU150010A-38	ST connector (replaceable, 3 sets)
MU150010A-39	DIN connector (replaceable, 3 sets)
MU150010A-40	SC connector (replaceable, 3 sets)
MU150010A-43	HMS-10/A connector (replaceable, 3 sets)
MU150001A/B-37	FC connector (replaceable, 1 set)
MU150001A/B-38	ST connector (replaceable, 1 set)
MU150001A/B-39	DIN connector (replaceable, 1 set)
MU150001A/B-40	SC connector (replaceable, 1 set)
MU150001A/B-43	HMS-10/A connector (replaceable, 1 set)
MU150002A-37	FC connector (replaceable, 1 set)*4
MU150002A-38	ST connector (replaceable, 1 set)*4
MU150002A-39	DIN connector (replaceable, 1 set)*4
MU150002A-40	SC connector (replaceable, 1 set)*4
MU150002A-43	HMS-10/A connector (replaceable, 1 set)*4
MU150017A/B-37	FC connector (user replaceable, 1 set)
MU150017A/B-38	ST connector (user replaceable, 1 set)
MU150017A/B-39	DIN connector (user replaceable, 1 set)
MU150017A/B-40	SC connector (user replaceable, 1 set)
MU150017A/B-43	HMS-10/A connector (user replaceable, 1 set)
MU150031A/C-37	FC connector (user replaceable, 1 set)
MU150031A/C-38	ST connector (user replaceable, 1 set)
MU150031A/C-39	DIN connector (user replaceable, 1 set)
MU150031A/C-40	SC connector (user replaceable, 1 set)
MU150031A/C-43	HMS-10/A connector (user replaceable, 1 set)
MU150061A/B-37	FC connector (user replaceable, 1 set)
MU150061A/B-38	ST connector (user replaceable, 1 set)
MU150061A/B-39	DIN connector (user replaceable, 1 set)
MU150061A/B-40	SC connector (user replaceable, 1 set)
MU150061A/B-43	HMS-10/A connector (user replaceable, 1 set)
	Maintenance service**5
MP1570A-90	Extension service 3 years
MP0121A-90	Extension service 3 years
MP0122A-90	Extension service 3 years
MP0122B-90	Extension service 3 years
MP0123A-90	Extension service 3 years
MU150005A-90	Extension service 3 years
MU150006A-90	Extension service 3 years
MU150007A-90	Extension service 3 years
MU150008A-90	Extension service 3 years
MU150009A-90	Extension service 3 years
MU150010A-90	Extension service 3 years
MU150011A-90	Extension service 3 years
MU150000A-90	Extension service 3 years
MU150001A-90	Extension service 3 years
MU150001B-90	Extension service 3 years
MU150002A-90	Extension service 3 years
MP0111A-90	Extension service 3 years
MP0112A-90	Extension service 3 years
MP0113A-90	Extension service 3 years
MP0105A-90	Extension service 3 years
MP0108A-90	Extension service 3 years
MU150017A/B-90	Extension service 3 years
MU150031A/C-90	Extension service 3 years
MU150061A/B-90	Extension service 3 years

Continued on next page

Model/Order No.	Name
	Application equipment
MP1777A	10 GHz Jitter Analyzer
MP9677B	E/O, O/E Converter
MU967701A	Clock Recovery Unit (9.95328 Gbit/s)
MP1580A	Portable 2.5G/10G Analyzer
MU150018A	2.5G/10G Jitter Unit (for MP1580A)
	Optional accessories
MN9320A	Optical Channel Drop Unit (OCD)
MX150001B	Wander (MTIE, TDEV) Measurement Application Software (supplied with MU150005A-02/150006A-02/150007A-02)
J0796A	ST connector (replaceable, with protective caps, 1 set)
J0796B	DIN connector (replaceable, with protective caps, 1 set)
J0796C	SC connector (replaceable, with protective caps, 1 set)
J0796D	HMS-10/A connector (replaceable, with protective caps, 1 set)
J0796E	FC connector (replaceable, with protective caps, 1 set)
J0162A	Balanced cable, 1 m (Siemens 3p-Siemens 3p)
J0162B	Balanced cable, 2 m (Siemens 3p-Siemens 3p)
J0845A	Balanced cable, 6 ft (BANTAM 3P/BANTAM 3P)
J0775D	Coaxial cable (BNC-P620 · 3C-2WS · BNC-P620, 75 Ω), 2 m
J0776D	Coaxial cable (BNC-P-3W · 3D-2W · BNC-P-3W, 50 Ω), 2 m
J0898A	Conversion cable (M-1PS · BANTAM 3P), 1 m
J0898B	Conversion cable (M-1PS · BANTAM 3P), 2 m
J0635A	Optical fiber cable, 1 m (SM, FC-SPC connector both ends)
J0635B	Optical fiber cable, 2 m (SM, FC-SPC connector both ends)
J0635C	Optical fiber cable, 3 m (SM, FC-SPC connector both ends)
J0660A	Optical fiber cable, 1 m (SM, SC connector, both-ends)
J0660B	Optical fiber cable, 2 m (SM, SC connector, both-ends)
J0660C	Optical fiber cable, 3 m (SM, SC connector, both-ends)
J0756A	Optical fiber cable, 1 m (SM, ST connector, both-ends)
J0756B	Optical fiber cable, 2 m (SM, ST connector, both-ends)
J0756C	Optical fiber cable, 3 m (SM, ST connector, both-ends)
J0747A	Fixed optical attenuator (5 dB)
J0747B	Fixed optical attenuator (10 dB)
J0747C	Fixed optical attenuator (15 dB)
J0747D	Fixed optical attenuator (20 dB)
J1049A	Fixed optical attenuator, SC (5 dB)
J1049B	Fixed optical attenuator, SC (10 dB)
J1049C	Fixed optical attenuator, SC (15 dB)
J1049D	Fixed optical attenuator, SC (20 dB)
J1050A	Fixed optical attenuator, ST (5 dB)
J1050B	Fixed optical attenuator, ST (10 dB)
J1050C	Fixed optical attenuator, ST (15 dB)
J1050D	Fixed optical attenuator, ST (20 dB)
J0322B	Coaxial cable (11SMA · SUCOFLEX104 · 11SMA), 1 m
J0008	GPIB cable, 2 m
A0006	Head set
B0453B	Blank panel (for front slot)
B0454C	Blank panel (for slot 1 to 3)
B0454D	Blank panel (for slot 4/5)
B0448	Soft case
B0336C	Carrying case

*1: Must specify SDH (Option 10) or SONET (Option 11) when ordering depends on your system. The option price is included in the MP1570A. These two options can be installed simultaneously. But in this case, one option price is charged.

*2: Specify the connector to be supplied as the standard connector when ordering the above options. If the connector is not specified the FC connector (MP0111A/0112A/0113A/0122B-37, MU150008A/150009A/150010A/150001A/150001B/150002A-37) is supplied as standard.

*3: The video output, RS-232C, GPIB and Ethernet options cannot all be used simultaneously. Only the video output + RS-232C, or video output + GPIB, or RS-232C + GPIB board, or Ethernet board combinations support simultaneous use, so change the board combinations according to the purpose.

*4: With Option 01, 2 sets

*5: Please ask your local Anritsu Field Office or Sales. Representative for price and availability.

The units for MP1552A/B and MP1555A/B can be used with MP1570A.

SONET/SDH/PDH/ATM ANALYZER
MP1570A1
 1.5 Mbit/s to 10 Gbit/s

Supports North American and European Mapping by One Box

NEW



CE GPIB OPTION

MP1570A1 is a SONET/SDH/PDH/ATM Analyzer which has one more slot compared with MP1570A. It can measure bit rate of 2488M (OC-48) or more in North American and European mapping without the DS_n and PDH plug-in units exchange.

Specifications

• **General**

(Other specifications are same as MP1570A. For the specification, refer to page 152.)

Printer	Internal, external
Internal memory	Measurement settings memory: 10 Graphics memory: 15
Others	FDD, RS-232C (Option 01) ^{*1} , GPIB (Option 02) ^{*1} , Ethernet (Option 03) ^{*1} , Video output (Option 04) ^{*1} , buzzer, clock, help, screen copy
EMC	EN61326: 1997/A1, 1998 (Class A) EN61000-3-2: 1995/A2, 1998 (Class A) EN61326: 1997/A1, 1998 (Annex A)
LVD	EN610101-1: 1993/A2, 1995 (Installation Category II, Pollution degree 2)
Dimensions and mass	320 (W) x 222 (H) x 350 (D) mm, 12 kg approx. (excluding plug-in units and options)
Power	100 to 240 Vac, 47.5 to 63 Hz, ≤500 VA
Temperature	0° to +40°C

*1: The video output, RS-232C, GPIB and Ethernet options cannot all be used simultaneously. Only the video output + RS-232C, or video output + GPIB, or RS-232C + GPIB board, or Ethernet board combinations support simultaneous use, so change the board combinations according to the purpose.

Ordering information

Please specify model/order number, name and quantity when ordering.

Model/Order No.	Name
MP1570A1 ^{*1}	Main frame SONET/SDH/PDH/ATM Analyzer
	Standard accessories
Z0169	AC power cord: 1 pc
F0079	Printer paper (5 rolls/pack): 1 pack
B0482	Fuse, 10 A: 2 pcs
J0907Q	Front cover: 1 pc
	Remote interlock cord (for MU150001A/B, MU150008A, MU150009A, MU150010A, MU150031A/C, MU150061A/B): 1 pc
J0908	Remote interlock terminator (for MU150001A/B, MU150008A, MU150009A, MU150010A, MU150031A/C, MU150061A/B): 1 pc
E0008A	Optical output control key (for MU150001A/B, MU150008A, MU150009A, MU150010A, MU150031A/C, MU150061A/B): 2 pc
J0747A	Fixed optical attenuator (5 dB, for MU150017A/B): 1 pc
J0747B	Fixed optical attenuator (10 dB, for MU150002A): 1 pc
J0900A	Coaxial cable (AA-165-200, 20 cm, for MU150011A): 2 pcs
J0635A	Optical fiber cable (FC · PC-FC · PC, 1 m, for MU150002A/150008A/150009A/150010A, MU150017A/B): 1 pc
MX150001B	Wander (MTIE, TDEV) Measurement Application Software (supplied with MU150005A-02/150006A-02/150007A-02): 1 pc
W1882AE	MP1570A1 operation manual: 1 copy
W1719AE	MP1570A operation manual (Vol. 1 Basic operation for SDH): 1 copy
W1720AE	MP1570A operation manual (Vol. 1 Basic operation for SONET): 1 copy
W1721AE	MP1570A operation manual (Vol. 2 Remote control): 1 copy
W1722AE	MP1570A operation manual (Vol. 3 ATM measurement): 1 copy
W1723AE	MP1570A operation manual (Vol. 4 2.5G/10G measurement): 1 copy

Continued on next page

Model/Order No.	Name
W1724AE	MP1570A operation manual (Vol. 5 Add/Drop function): 1 copy
W1725AE	MP1570A operation manual (Vol. 6 Jitter/wander measurement, for MU150005A/150006A/150007A): 1 copy
W1726AE	MP1570A operation manual (Vol. 7 2.5G jitter/wander measurement, for MU150011A): 1 copy
W1763AE	Wander (MTIE, TDEV) Measurement Application Software (supplied with MX150001B): 1 copy
J1002A	Semi-rigid cable (for MU150001A/B, MU150031A/C, MU150061A/B): 2 pcs
J1002B	Semi-rigid cable (for MU150002A, MU150017A/B): 2 pcs
J1002C	Semi-rigid cable (for MU150000A): 3 pcs
Plug-in units	
MP0121A	2/8/34/139/156M Unit
MP0122A	1.5/45/52M Unit
MP0122B*2	1.5/45/52/52M (1.31) Unit
MP0123A	ATM Unit
MU150005A	2/8/34/139M, 156/622M Jitter Unit (only jitter generation/measurement, requires MP0121A)
MU150006A	1.5/45/52M, 156/622M Jitter Unit (only jitter generation/measurement, requires MP0122A/B)
MU150007A	2/8/34/139M, 1.5/45/52M, 156/622M Jitter Unit (only jitter generation/measurement, requires MP0121A or MP0122A/B)
MU150008A*2	2.5G (1.31) Unit (with optical power meter)
MU150009A*2	2.5G (1.55) Unit (with optical power meter)
MU150010A*2	2.5G (1.31/1.55) Unit (with optical power meter)
MU150011A	2.5G Jitter Unit (only jitter generation/measurement, requires MU150008A, MU150009A, or MU150010A)
MP0131A	Add/Drop Unit
MU150000A	2.5G/10G Unit
MU150001A*2	Optical 10G Tx (1.55) Unit (2 km transmission)
MU150001B*2	Optical 10G Tx (1.55) Unit (40 km transmission)
MU150002A*2	Optical 10G Rx (Narrow) Unit (with optical power meter)
MP0111A*2	Optical 156M/622M (1.31) Unit (with optical power meter)
MP0112A*2	Optical 156M/622M (1.55) Unit (with optical power meter)
MP0113A*2	Optical 156M/622M (1.33/1.55) Unit (with optical power meter, 1.31/1.55 switchable)
MU150017A	Optical 10G Rx (Wide) Unit
MU150017B	Optical 2.5G/10G Rx (Wide) Unit
MU150031A	Optical 10G Tx (1.55) High Power Unit
MU150031C	Optical 2.5G/10G Tx (1.55) High Power Unit
MU150061A	Optical 10G Tx (1.31) Unit
MU150061B	Optical 2.5G/10G Tx (1.31) Unit
MP0105A	CMI Unit
MP0108A	NRZ Unit
Options	
MP1570A1-01*3	RS-232C
MP1570A1-02*3	GPIB
MP1570A1-03*3	Ethernet
MP1570A1-04*3	VGA output
MP1570A1-06	MUX/DEMUX (2/8/34/139 Mbit/s, for MP0121A)
MP1570A1-07	MUX/DEMUX (1.5/45 Mbit/s, for MP0122A/B)
MP1570A1-08	45M-2M MUX/DEMUX (requires MP0121A and MP0122A/B)
MP1570A1-09	Japan mapping (requires MP0122A or MP0122B)
MP1570A1-10*1	SDH
MP1570A1-11*1	SONET
MP1570A1-13	Frame memory capture (156M/622M, 64 frame)
MP1570A1-14	IP-over-SONET/SDH (requires option of frame memory/capture)
MP1570A1-15	IP-over-ATM (requires MP0123A)
MP1570A1-22	K1/K2 overwrite through
MU150005A-02	Wander measurement
MU150006A-02	Wander measurement
MU150007A-02	Wander measurement
MU150005A-03	Wander reference output
MU150006A-03	Wander reference output
MU150007A-03	Wander reference output
MU150008A-01	Frame memory capture (2.5G, 64 frame)
MU150009A-01	Frame memory capture (2.5G, 64 frame)
MU150010A-01	Frame memory capture (2.5G, 64 frame)
MU150000A-01	Frame memory capture (2.5G/10G, 26 frame)
MU150001A/B-01	2.5G (1.31)
MU150001A/B-02	2.5G (1.55)
MU150001A/B-03	2.5G (1.31/1.55)
MU150002A-01	2.5G
MU150002A-04	Available for 10G (1.31)
MP0111A/0112A-37	FC connector (replaceable, 2 sets)
MP0111A/0112A-38	ST connector (replaceable, 2 sets)
MP0111A/0112A-39	DIN connector (replaceable, 2 sets)

Model/Order No.	Name
MP0111A/0112A-40	SC connector (replaceable, 2 sets)
MP0111A/0112A-43	HMS-10/A connector (replaceable, 2 sets)
MP0113A-37	FC connector (replaceable, 3 sets)
MP0113A-38	ST connector (replaceable, 3 sets)
MP0113A-39	DIN connector (replaceable, 3 sets)
MP0113A-40	SC connector (replaceable, 3 sets)
MP0113A-43	HMS-10/A connector (replaceable, 3 sets)
MP0122B-37	FC connector (replaceable, 2 sets)
MP0122B-38	ST connector (replaceable, 2 sets)
MP0122B-39	DIN connector (replaceable, 2 sets)
MP0122B-40	SC connector (replaceable, 2 sets)
MP0122B-43	HMS-10/A connector (replaceable, 2 sets)
MU150008A-37	FC connector (replaceable, 2 sets)
MU150008A-38	ST connector (replaceable, 2 sets)
MU150008A-39	DIN connector (replaceable, 2 sets)
MU150008A-40	SC connector (replaceable, 2 sets)
MU150008A-43	HMS-10/A connector (replaceable, 2 sets)
MU150009A-37	FC connector (replaceable, 2 sets)
MU150009A-38	ST connector (replaceable, 2 sets)
MU150009A-39	DIN connector (replaceable, 2 sets)
MU150009A-40	SC connector (replaceable, 2 sets)
MU150009A-43	HMS-10/A connector (replaceable, 2 sets)
MU150010A-37	FC connector (replaceable, 3 sets)
MU150010A-38	ST connector (replaceable, 3 sets)
MU150010A-39	DIN connector (replaceable, 3 sets)
MU150010A-40	SC connector (replaceable, 3 sets)
MU150010A-43	HMS-10/A connector (replaceable, 3 sets)
MU150001A/B-37	FC connector (replaceable, 1 set)
MU150001A/B-38	ST connector (replaceable, 1 set)
MU150001A/B-39	DIN connector (replaceable, 1 set)
MU150001A/B-40	SC connector (replaceable, 1 set)
MU150001A/B-43	HMS-10/A connector (replaceable, 1 set)
MU150002A-37	FC connector (replaceable, 1 set*4)
MU150002A-38	ST connector (replaceable, 1 set*4)
MU150002A-39	DIN connector (replaceable, 1 set*4)
MU150002A-40	SC connector (replaceable, 1 set*4)
MU150002A-43	HMS-10/A connector (replaceable, 1 set*4)
MU150017A/B-37	FC connector (user replaceable, 1 set)
MU150017A/B-38	ST connector (user replaceable, 1 set)
MU150017A/B-39	DIN connector (user replaceable, 1 set)
MU150017A/B-40	SC connector (user replaceable, 1 set)
MU150017A/B-43	HMS-10/A connector (user replaceable, 1 set)
MU150031A/C-37	FC connector (user replaceable, 1 set)
MU150031A/C-38	ST connector (user replaceable, 1 set)
MU150031A/C-39	DIN connector (user replaceable, 1 set)
MU150031A/C-40	SC connector (user replaceable, 1 set)
MU150031A/C-43	HMS-10/A connector (user replaceable, 1 set)
MU150061A/B-37	FC connector (user replaceable, 1 set)
MU150061A/B-38	ST connector (user replaceable, 1 set)
MU150061A/B-39	DIN connector (user replaceable, 1 set)
MU150061A/B-40	SC connector (user replaceable, 1 set)
MU150061A/B-43	HMS-10/A connector (user replaceable, 1 set)
Maintenance service*5	
MP0121A-90	Extension service 3 years
MP0122A-90	Extension service 3 years
MP0122B-90	Extension service 3 years
MP0123A-90	Extension service 3 years
MU150005A-90	Extension service 3 years
MU150006A-90	Extension service 3 years
MU150007A-90	Extension service 3 years
MU150008A-90	Extension service 3 years
MU150009A-90	Extension service 3 years
MU150010A-90	Extension service 3 years
MU150011A-90	Extension service 3 years
MU150000A-90	Extension service 3 years
MU150001A-90	Extension service 3 years
MU150001B-90	Extension service 3 years
MU150002A-90	Extension service 3 years
MP0111A-90	Extension service 3 years
MP0112A-90	Extension service 3 years
MP0113A-90	Extension service 3 years
MP0105A-90	Extension service 3 years
MP0108A-90	Extension service 3 years
MU150017A/B-90	Extension service 3 years
MU150031A/C-90	Extension service 3 years
MU150061A/B-90	Extension service 3 years
Application equipment	
MP1777A	10 GHz Jitter Analyzer
MP9677B	E/O, O/E Converter
MP967701A	Clock Recovery Unit (9.95328 Gbit/s)
MP1580A	Portable 2.5G/10G Analyzer
MU150018A	2.5G/10G Jitter Unit (for MP1580A)

Continued on next page

Model/Order No.	Name
Optional accessories	
J0796A	ST connector (replaceable, with protective caps, 1 set)
J0796B	DIN connector (replaceable, with protective caps, 1 set)
J0796C	SC connector (replaceable, with protective caps, 1 set)
J0796D	HMS-10/A connector (replaceable, with protective caps, 1 set)
J0796E	FC connector (replaceable, with protective caps, 1 set)
J0162A	Balanced cable (Siemens 3P-Siemens 3P), 1 m
J0162B	Balanced cable (Siemens 3P-Siemens 3P), 2 m
J0845A	Balanced cable (BANTAM 3P/BANTAM 3P), 6 ft
J0775D	Coaxial cable (BNC-P620 · 3C-2WS · BNC-P620, 75 Ω), 2 m
J0776D	Coaxial cable (BNC-P-3W · 3D-2W · BNC-P-3W, 50 Ω), 2 m
J0898A	Conversion cable (M-1PS · BANTAM 3P), 1 m
J0898B	Conversion cable (M-1PS · BANTAM 3P), 2 m
J0635A	Optical fiber cable (SM, FC-SPC connector both ends), 1 m
J0635B	Optical fiber cable (SM, FC-SPC connector both ends), 2 m
J0635C	Optical fiber cable (SM, FC-SPC connector both ends), 3 m
J0660A	Optical fiber cable, 1 m (SM, SC connector, both-ends)
J0660B	Optical fiber cable, 2 m (SM, SC connector, both-ends)
J0660C	Optical fiber cable, 3 m (SM, SC connector, both-ends)
J0756A	Optical fiber cable, 1 m (SM, ST connector, both-ends)
J0756B	Optical fiber cable, 2 m (SM, ST connector, both-ends)
J0756C	Optical fiber cable, 3 m (SM, ST connector, both-ends)
J0747A	Fixed optical attenuator (5 dB)
J0747B	Fixed optical attenuator (10 dB)
J0747C	Fixed optical attenuator (15 dB)
J0747D	Fixed optical attenuator (20 dB)
J1049A	Fixed optical attenuator, SC (5 dB)
J1049B	Fixed optical attenuator, SC (10 dB)
J1049C	Fixed optical attenuator, SC (15 dB)
J1049D	Fixed optical attenuator, SC (20 dB)
J1050A	Fixed optical attenuator, ST (5 dB)
J1050B	Fixed optical attenuator, ST (10 dB)
J1050C	Fixed optical attenuator, ST (15 dB)
J1050D	Fixed optical attenuator, ST (20 dB)
J0322B	Coaxial cable (11SMA · SUCOFLEX104 · 11SMA), 1 m
A0008	GPIB cable, 2 m
A0006	Head set
B0453B	Blank panel (for front panel)
B0454C	Blank panel (for Slot 1 to 3)
B0454D	Blank panel (for Slot 4/5)

- *1: Must specify SDH (Option 10) or SONET (Option 11) when ordering depends on your system. The option price is included in the MP1570A1. These two options can be installed simultaneously. But in this case, one option price is charged.
- *2: Specify the connector to be supplied as the standard connector when ordering the above options. If the connector is not specified the FC connector MP0111A/0112A/0113A/0122B-37, MU150008A/150009A/150010A/150001A/150001B/150002A-37) is supplied as standard.
- *3: The video output, RS-232C, GPIB and Ethernet options cannot all be used simultaneously. Only the video output + RS-232C, or video output + GPIB, or RS-232C + GPIB board, or Ethernet board combinations support simultaneous use, so change the board combinations according to the purpose.
- *4: With Option 01, 2 sets
- *5: Please ask your local Anritsu Field Office or Sales Representative for price and availability.

PORTABLE 2.5G/10G ANALYZER MP1580A

For 2.5G/10G Jitter/Wander Measurements

NEW

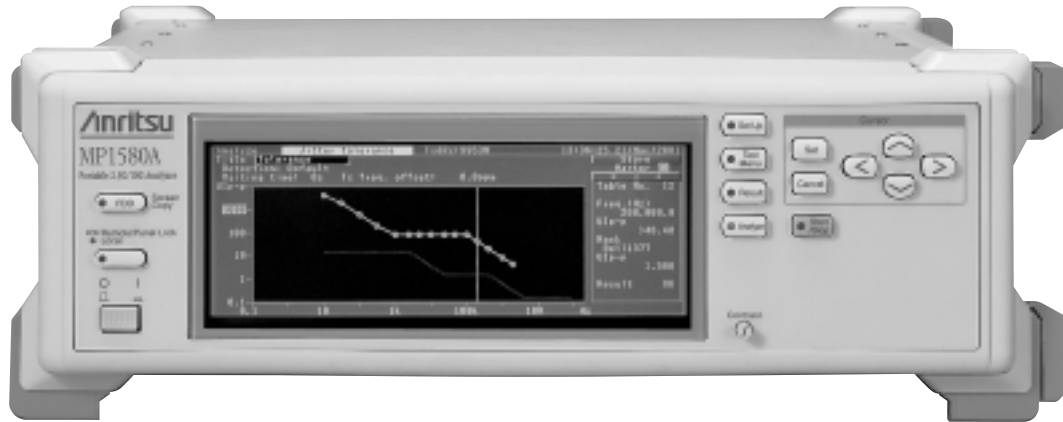

The MP1580A is a unique and powerful solution for analyzing jitter at the standard OC-48/192 or STM-16/64 bit rates. It can measure jitter of 2.5G/10G electrical interfaces (clock signal) with a simple operation. In addition, when used in combination with the MP1570A SONET/SDH/PDH/ATM Analyzer, evaluation of jitter characteristics in digital transmission lines, systems and devices, such as — jitter tolerance, jitter transfer, jitter generation, etc., can be performed easily.

Functions

- Complies with the latest ITU-T O.172 and Bellcore GR-1377 standards

The MP1580A conforms to both the OC-192/STM-64 jitter measurement standards and supports required jitter modulation amplitude of 4000 Ulp-p and 80 MHz jitter bandwidth.

- Supports 10 GHz wander measurement according to the latest ITU-T G.813 standard (option)

The MP1580A can generate and measure various types of wander. It can generate wander in the frequency range of 10 μ Hz to 10 Hz at 400,000 Ulp-p max. In addition, MTIE/TDEV can be measured in real-time using an external PC and optional application software (MX150002A).

- Single cabinet support for both 2.5G and 10G jitter/wander measurements

Just one MP1580A is required for 2.5G and 10G jitter generation and analysis. When combined with the MP1570A and MU150000A, jitter can be added to SONET/SDH signals and measured.

- Differences from existing instrument (MP1777A)

Anritsu launched the MP1777A 10 GHz Jitter Analyzer in February of 1998, as a jitter measurement solution for OC-192/STM-64 (9953M). The new MP1580A Portable 2.5G/10G Jitter Analyzer is providing more convenience in measurement without the need for ancillary equipment (network analyzer, external E/O-O/E converter). Anritsu has also developed a Wide Band O/E Converter (MU150017A/B) for the MP1570A to support jitter measurement of 80 MHz at 9953.28 Mbit/s as required by ITU-T standard in conjunction with the MP1580A. Although it uses two cabinets, the compact size makes the system ideal for R&D, manufacturing, installation and maintenance. In addition, the MP1570A can be controlled from the MP1580A for performing automatic measurements, such as Jitter Tolerance and Jitter Transfer.

Application

- Output jitter measurement

The MP1580A can easily measure the jitter clock signal (electrical interface only) by just inputting the output clock of DUT directly.



Optical signals can be measured easily by combining the MP1580A with the MP1570A, MU150000A, MU150001A and MU150017A/B.

- Jitter tolerance measurement

When the MP1580A is used with the MP1570A (send/receive jittered clock), jitter tolerance tests can be performed on OC-192/STM-64 and OC-48/STM-16 signals of electrical and optical interfaces.

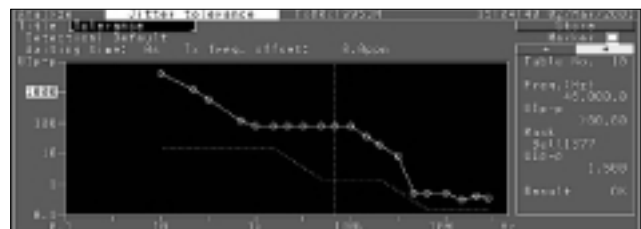

• Jitter transfer measurement

When the MP1580A is used with the MP1570A (send/receive jittered clock), jitter transfer tests can be performed on OC-192/STM-64 and OC-48/STM-16 signals of electrical and optical interfaces.

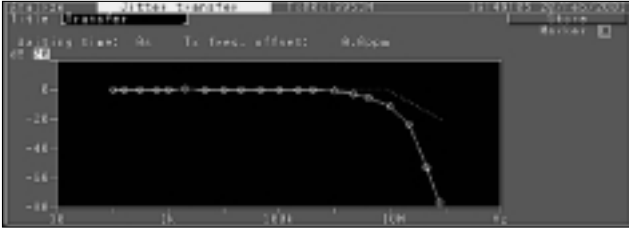

• Wander generation and measurement

The MP1580A can generate and measure of wander conforming to ITU-T O.172 and also generation of TDEV conforming to ITU-T G.813. It also can measure TIE (Time Interval Error) by itself and measure MTIE and TDEV by connection of an external PC in which MX150002A is installed.

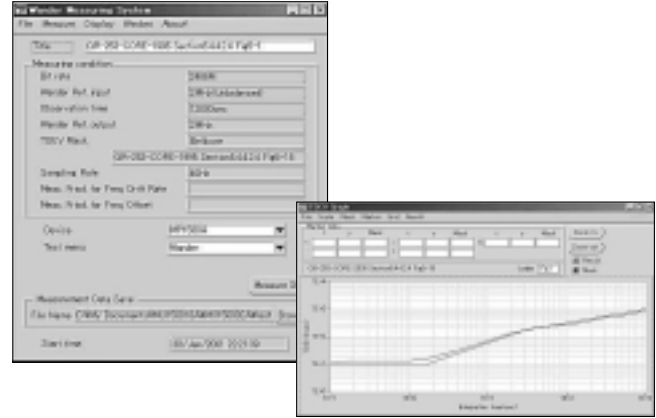

Specifications

Frequency
 Range: 9953.28, 2488.32 MHz
 Offset range: ± 100 ppm
 Resolution: 0.1 ppm
 Accuracy: ± 0.1 ppm (calibrate after 60 min warm-up, $23 \pm 5^\circ\text{C}$)
 Generation function: Clock signal output, data signal output (with MP1570A), jitter on, wander on/off
 Modulation source: Internal (sine wave), external (for jitter generation function only)
 Modulation frequency accuracy: $f_m \pm 100$ ppm (0.1 Hz to 80 MHz)
 Jitter generation: Conform to ITU-T O.172

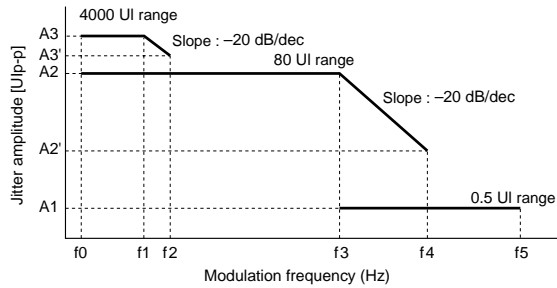

Bit rate (bit/s)	f0 (Hz)	f1 (Hz)	f2 (Hz)	f3 (kHz)	f4 (MHz)	f5 (MHz)	A1 (Ulp-p)	A2' (Ulp-p)	A2 (Ulp-p)	A3' (Ulp-p)	A3 (Ulp-p)
9953.28M	0.1	15	600	100	2	80	0.5	4	80	100	4000

0.5 UI range: 0.000 to 0.505 Ulp-p (0.001 Ulp-p steps)
 80 UI range: 0.00 to 80.80 Ulp-p (0.05 Ulp-p steps)
 4000 UI range: 0 to 4040 Ulp-p (2 Ulp-p steps)

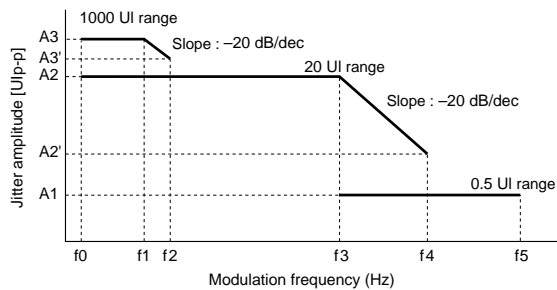

Bit rate (bit/s)	f0 (Hz)	f1 (Hz)	f2 (Hz)	f3 (kHz)	f4 (MHz)	f5 (MHz)	A1 (Ulp-p)	A2' (Ulp-p)	A2 (Ulp-p)	A3' (Ulp-p)	A3 (Ulp-p)
2488.32M	0.1	15	600	100	2	20	0.5	1	20	25	1000

0.5 UI range: 0.000 to 0.505 Ulp-p (0.001 Ulp-p steps)
 20 UI range: 0.00 to 20.20 Ulp-p (0.01 Ulp-p steps)
 1000 UI range: 0 to 1010 Ulp-p (1 Ulp-p steps)

Jitter generation

Continued on next page

Wander generation

Wander generation: 10 μ Hz to 10 Hz, 0 to 400,000 Ulp-p (1 Ulp-p steps), conform to ITU-T O.172

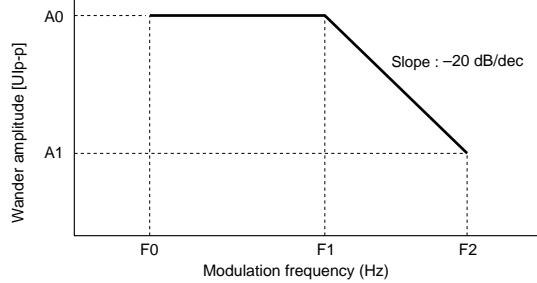

Bit rate (bit/s)	F0 (μ Hz)	F1 (mHz)	F2 (Hz)	A0 (Ulp-p)	A1 (Ulp-p)	Steps (Ulp-p)
2488.32M	10	400	10	400,000	16,000	1
9953.28M	10	400	10	400,000	16,000	1

Measurement functions: Ulp-p, UI + peak, UI – peak, UIrms, hit count, hit second, %F second, peak jitter
 Measurement mode: Repeat, single, manual
 Display: Current, last
 Measurement interval: 1 to 99 s, 1 to 99 min, 1 to 99 h, 1 to 99 day
 Jitter measurement: Conform to ITU-T O.172

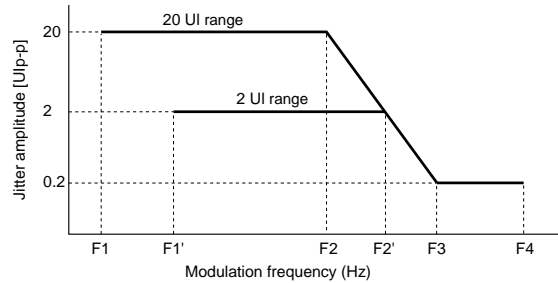

Bit rate (bit/s)	Range (UI)	F1 (Hz)	F1' (Hz)	F2 (kHz)	F2' (kHz)	F3 (MHz)	F4 (MHz)
2488.32M	2	—	100	—	100	1	20
	20	10	—	10	—	1	20
9953.28M	2	—	100	—	400	4	80
	20	10	—	40	—	4	80

Jitter measurement

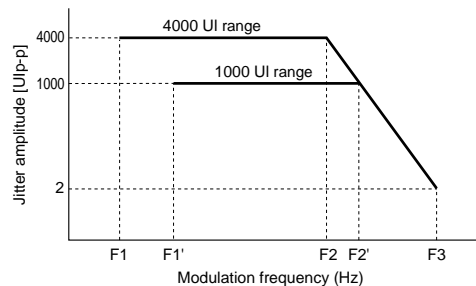

Bit rate (bit/s)	Range (UI)	F1 (Hz)	F1' (Hz)	F2 (Hz)	F2' (Hz)	F3 (kHz)
2488.32M	1000	—	1	—	12.1	5
9953.28M	4000	1	—	12.1	—	20

Ulp-p measurement

- 2 UI range: 0.000 to 2.020 Ulp-p (0.001 Ulp-p steps)
- 20 UI range: 0.00 to 20.20 Ulp-p (0.01 Ulp-p steps)
- 1000 UI range: 0 to 1010 Ulp-p (1 Ulp-p steps, 2488.32 Mbit/s only)
- 4000 UI range: 0 to 4040 Ulp-p (2 Ulp-p steps, 9953.28 Mbit/s only)

UI rms measurement

- 2 UI range: 0.000 to 0.714 UIrms (0.001 UIrms steps)
- 20 UI range: 0.00 to 7.17 UIrms (0.01 UIrms steps)

Filters:

Confirming to ITU-T O.172 and Bellcore GR1377
 LP, HP0 + LP, HP1 + LP, HP1' + LP, HP2 + LP, HP + LP, HP' + LP, LP' (1000/4000 UI range only),
 HP0 + LP' (1000/4000 UI range only)

Bit rate (bit/s)	HP0 (Hz)	HP1 (kHz)	HP1' (kHz)	HP2 (MHz)	HP' (kHz)	HP (kHz)	LP (MHz)	LP' (kHz)
2488.32M	10	5	—	1	—	12	20	5
9953.28M	10	10	20	4	50	12	80	20

Reference wander generation (Option 03)	Off: Able to set non-modulated status* TDEV mask: The 37 types of TDEV masks that are regulated by ITU-T, ETSI, ANSI, and Bellcore standards are available as default. It is possible to add the wander modulation on the user specified TDEV mask. Transient: It is possible to change the A (1 - e ^{-63.7t}) phase by the timing of the start. Signal off: It is possible to disconnect the standard signal. Wander tolerance (TDEV) measurement: Evaluation by the various TDEV mask generations
Wander measurement (Option 02)	Conform to ITU-T O.172 Reference input: 2.048M (HDB3, clock), 1.544M (AMI/B8ZS, clock), 64k + 8 kHz, 5 MHz, 10 MHz Sampling frequency: 40 Hz, 1 Hz, 0.1 Hz (select by MX150002A) Measurement range P-P: 0.0 to 2E10 ns, +P/-P: 0.0 to 1E10 ns, TIE: 0.0 to ±1E10 ns Measurement time: 10 to 1 x 10 ⁸ s (max. 120,000 s; MP1570A only) Wander application (requires MX150002A Wander Application Software) TIE: Max. 1 x 10 ⁸ s, MTIE: Max. 1 x 10 ⁸ s, TDEV: Max. 1 x 10 ⁶ s Frequency offset: Measurement conforms to ANSI T1.105.09 Frequency drift rate: Measurement conforms to ANSI T1.105.09 Wander tolerance (TDEV) measurement: Evaluation by the various TDEV mask generations
Other measurement	Jitter transfer, frequency measurement, jitter tolerance, jitter sweep, frequency sweep, wander sweep (with MP1570A)
Dimensions and mass	320 (W) x 100 (H) x 350 (D) mm, ≤10 kg (with MU150018A)
Power	≤250 VA
Temperature range	0° to +40°C (operating), -20° to +60°C (storage)
EMC	EN61326: 1997/A1, 1998 (Class A) EN61000-3-2: 1995/A2, 1998 (Class A) EN61326: 1997/A1, 1998 (Annex A)
LVD	EN610101-1: 1993/A2, 1995 (Installation Category II, Pollution degree 2)

*: Only non-modulated status can be set without this option.

Ordering information

Please specify model/order number, name and quantity when ordering.

Model/Order No.	Name
MP1580A	Main frame Portable 2.5G/10G Analyzer
	Standard accessories
	AC power cord: 1 pc
F0093A	Fuse, 6.3 A: 1 pc
B0489	Front cover: 1 pc
W1889AE	MP1580A operation manual (Vol 1 Jitter/wander): 1 copy
W1890AE	MP1580A operation manual (Vol 2 Remote control): 1 copy
MX150002A	Wander Measurement Application Software (MTIE/TDEV) *Supplied with MU150018A-02: 1 pc
W1892AE	MX150002A operation manual (wander application) *Supplied with MX150002A: 1 copy
J1074	Semirigid cable Tx (for connection to MP1570A): 1 pc
J1075	Semirigid cable Rx (for connection to MP1570A): 1 pc
MU150018A	Plug-in unit 2.5G/10G Jitter Unit
	Options
MP1580A-01	RS-232C
MP1580A-02	GPIB
MP1580A-04	VGA
MU150018A-02	Wander measurement
MU150018A-03	Wander reference output phase modulation
	Maintenance service
MP1580A-90	Extension service 3 years
MU150018A-90	Extension service 3 years
	Peripherals
MP1570A	SONET/SDH/PDH/ATM Analyzer
MP1570A-02	GPIB (requires to combine with MP1580A)
MP1570A-10*	SDH
MP1570A-11*	SONET
MU150000A	2.5G/10G Unit (electrical for MP1570A)
MU150001A	Optical 10G Tx (1.55) Unit *2 km, for MP1570A
MU150001B	Optical 10G Tx (1.55) Unit *40 km, for MP1570A
MU150001A/B-01	2.5G (1.31, option for MP1570A)
MU150001A/B-02	2.5G (1.55, option for MP1570A)
MU150001A/B-03	2.5G (1.31/1.55, option for MP1570A)
MU150017A	Optical 10G Rx (Wide) Unit *For MP1570A
MU150017B	Optical 2.5G/10G Rx (Wide) Unit *For MP1570A
MP9677B	E/O, O/E Converter
MU967701A	Clock Recovery Unit (9953.28 MHz) *For MP9677B
MP35A	Matching Transformer (BNC-J/Siemence, C42334-A282, 75/120 Ω)

Model/Order No.	Name
	Optical accessories
J0661A	RS232C cable (cross cable with D-sub 9 pin connector at both ends), 2 m
J0006	GPIB cable, 0.5 m
J0007	GPIB cable, 1 m
J0008	GPIB cable, 2 m
J0696A	Coaxial cord (AA-165-500), 0.5 m
J0696C	Coaxial cord (AA-165-1000), 1 m
J0900E	Coaxial cord (AA-165-1500), 1.5 m
J0162A	Balanced cord (Siemence 3P · Siemence 3P), 1 m
J0162C	Balanced cord (Siemence 3P · Siemence 3P), 2 m
J0845A	Balanced cord, (Bantam 3P · Bantam 3P), 6 ft
J0775D	Coaxial cord (BNC-P620 · 3C-2WS · BNC-P620, 75 Ω), 2 m
J0776D	Coaxial cord (BNC-P-3W · 3D-2W · BNC-P-3W, 50 Ω), 2 m
B0490	Joint plate (to mount MP1580A and MP1570A in a stack)
B0491	Soft case
B0492	Hard carrying case

*: Must specify SDH (Option 10) or SONET (Option 11) when ordering depends on your systems. The option price is included in the MP1570A. These two options can be installed simultaneously. But in this case, one option is charged.

DATA QUALITY ANALYZER
MD1230A

Complete Performance Testing and Monitoring with One Unit

NEW



IP Networks are spreading rapidly throughout society in line with the expansion of networks carrying voice, video, and mission-critical data. And now maintenance of network quality has become an important theme. Development of network equipment and systems requires the measurement of network performance and QoS evaluations. In addition, network operations and maintenance require monitoring of in-service traffic, latency, and frame arrival time variation (frame jitter) as well as prompt troubleshooting. The MD1230A integrates both performance testing and network monitoring into one instrument.

Applications

• **R&D**

RFC2544 test

The six standard RFC1242 and RFC2544 tests: Throughput, Latency, Frame Loss Rate, Back-to-Back-Frame, System Recovery, and Reset, can be performed automatically with the results displayed graphically or in table form. The test efficiency has been improved through automation.

BGP4 link flap/route flap test

The MD1230A can emulate the BGP4 (Border Gateway Protocol version 4) speaker for a maximum of 8 devices. It can also perform link flap tests for neighboring routers and route flap tests for up to 800 routes. (However, it cannot use routes advertised by the DUT in the route flap test.)

• **Manufacturing**

Automated testing using GPIB commands (MD1230A Option 02)

Preset test items for production lines of network devices, etc., can be executed automatically and the measurement results saved. The MD1230A supports GPIB commands and almost all its functions can be executed via GPIB. In addition, several MD1230As can be controlled from one controller. Since the automated control programs use well-known GPIB commands, users' development costs of application software can be saved.

• **Maintenance**

VPN QoS traffic monitoring

Since traffic can be measured according to 8 priority levels based on the VLAN tag user priority field specified by IEEE802.1D and the least 3 bits of the DSCP field specified by RFC2474, it is also possible to measure QoS traffic for other packets not generated by the MD1230A.

If user-defined filters are used, VoIP traffic (specified UDP port number) to which specific MPLS labels are appended can be measured in real time.

Protocol analysis

Layer 2 to Layer 4 protocol decode can be performed on captured packets. Any problems with frame transportation are basically covered by the MD1230A protocol decode function of Layer 2 to Layer 4.

Remote latency (MD1230A Option 05)

The MD1230A has an optional GPS function and it can perform time synchronization with remote MD1230A units to measure frame latency of a long distance. Moreover, the capture function can be triggered when the measured latency exceeds the user setting. At present, there are services for guaranteeing VPN latency but if these services develop a fault, the MD1230A is very helpful.

Functions

• **Physical interface for 10 Mbit/s to 10 Gbit/s**

The MD1230A has the interface modules shown in the table below, and other interface modules will be added to the list. The Gigabit Ethernet Module has a Giga-Bit Interface Converter (GBIC) that can be changed to support 1000BASE-SX/LX/LH/ZX ports.

10/100M Ethernet Module	8 ports
Gigabit Ethernet Module	2 ports
2.5G (1.31) Module	1 port
2.5G (1.55) Module	1 port
10G (1.31) Module	1 port
10G (1.55) Module	1 port

• Expandable to 320 ports (100BASE-TX)

Any combination of five interface modules can be installed in the MD1230A. Moreover, a maximum of eight MD1230A units can be daisy chained via Ethernet with one unit acting as a controller for all units. Furthermore, time synchronization is performed by connecting a clock to the daisy chain. Latency between any ports can be measured. The number of ports can be expanded up to a maximum of 320 by using the 10M/100M Ethernet module.

Module	10M/100M Ethernet	Gigabit Ethernet	2.5G	10G
No. of ports/module	8	2	1	1
No. of modules/unit	5	5	5	5
No. of ports/unit	40	10	5	5
No. of ports for 8 connections	320	80	40	40

• Powerful and flexible filter/trigger conditions

The MD1230A has powerful and flexible filter and trigger functions that can be set independently for each port as shown in the following table.

Trigger condition	Filter condition	Condition	Remarks
✓	✓	Destination MAC address	10M/100M Ethernet and Gigabit Ethernet support those conditions. MAC address mask permits portion match.
✓	✓	Source MAC address	
✓	✓	Destination IP address	2.5G (1.31), 2.5G (1.55), 10G (1.31), 10G (1.55) support those conditions. IP address mask permits portion match
✓	✓	Source IP address	
✓	✓	User-defined 32 bit pattern	Two sets of user-defined 32 bit pattern conditions per port. Sets offset and pattern match at any frame position. Pattern mask permits portion match.
✓	✓	User-defined 32 bit pattern	
✓	✓	Error condition	Good frame, FCS error, undersize, fragment, oversize, oversize/FCS error, dribble error, alignment error, IP header checksum error, TCP header checksum error, UDP header checksum error
✓	✓	Ext. trigger input	Rising edge of pulse
✓	—	Traffic over	When traffic setting overflows
✓	—	Latency over	When latency setting overflows

As an example, when filtering only VoIP frames on an MPLS network, the MPLS label is specified as a 32 bit pattern (1), and VoIP frames are specified at the UDP header port number field as a 32 bit pattern (2). As a result, if only VoIP frames are captured on the specified MPLS network, the number of packets can be counted.

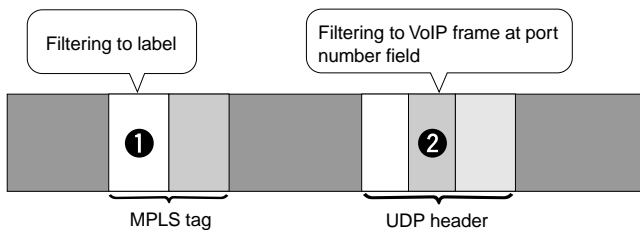

• Support for MPLS, IPv6, BGP4, etc., protocol decode

The 256 Mbyte max. capture buffer does not drop frames even at the full wire rate of 10 Gbit/s. The in-service capture function is an especially powerful and useful tool for troubleshooting the causes of network faults. Captured frames can be searched on the basis of specified conditions and interesting frames can be selected and displayed. Each port has an independent capture buffer and is unaffected by other ports.

Moreover, each of the Ethernet, PPP, LCP, MPLS, VLAN, ARP, IPv4, ICMP, IPv6, TCP, UDP, IGMP, RIP, BGP4 and DHCP protocols can be decoded and displayed for captured frames. When 10M/100M Ethernet and Gigabit Ethernet, IPX can be decoded.

• Real-time measurement of in-service traffic

Traffic monitoring

The MD1230A can measure send and receive byte/frame counts, QoS frame counts in 8 priority ranks, counts of each error type, count of SONET/SDH alarms, etc., in real time. In addition, when the above-described filter function is used, specific frame traffic can be measured for each port. This is an extremely powerful function — for example, in VPN services, specific MPLS VoIP frames (specified by UDP port number) can be extracted.



Latency

The MD1230A is able to measure the latency of simplex data transfer. When up to eight MD1230A units are daisy chained, latency can be measured by interconnecting a clock signal for time synchronization. In addition, when a GPS antenna is connected, latency can be measured between remote locations.

• Full wire rate transmission of user-edited data stream

The MD1230A can send a maximum of 256 data streams per port at the full wire rate. Data editing is a simple three-step procedure described below.

Step 1: Setting frame data

The frame editor is used to edit the frame data for any of the Ethernet, PPP, Cisco HDLC, ARP, IPv4, IPv6, IPX, MPLS, VLAN, TCP, UDP, IGMP, RIP and DHCP protocols. The protocol header format is displayed on screen, and header input by the user is also supported. Part or all of the IP address and MAC address can be set to increment, decrement or random. When IPv6, IP address portion of 32 bits less can be set to increment, decrement or random.



Step 2: Setting stream control

The interval gap of the frame set in step 1 is set and the data stream is defined. Commonly, an actual network load is not a stationary load but a burst load. To simulate this type of load, the MD1230A has a multi-burst function. In addition, a random frame interval can be simulated by setting to random within a specified packet interval range.



Step 3: Combining Data Stream

Up to 256 data streams defined in step 2 can be combined per port. Any number of data streams can also be repeated a specified number of times.

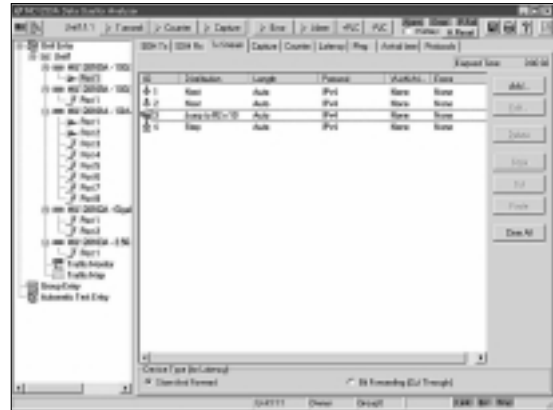

• Compact and lightweight unit with built-in Windows®98 OS

For easy and familiar operability, the MD1230A uses the built-in Windows®98. In addition, it also has a USB port for connecting a printer or external storage media. A PS/2 keyboard connector and USB connector on the front panel support connection of a keyboard and USB mouse. The MD1230A's easy operability, compact size and lightweight offer the perfect solution for convenient on-site troubleshooting.

• Remote control from PC

When the MX123001A Data Quality Analyzer Control Software (sold separately) is installed in a PC running Windows®98, up to eight MD1230A units can be controlled via a network.

• Automated measurement using GPIB commands (Option)

Almost all the MD1230A functions can be executed by GPIB commands. An automated test system can be configured by operating the MD1230A from the user's application software. In addition, the interface for sending and receiving GPIB commands can be selected from any of the optional GPIB (MD1230A Option 02), RS-232C (MD1230A Option 01) and Ethernet (MD1230A Option 03) interfaces.

Specifications

• MD1230A (main frame)

Sync clock input	Frequency: 64 kHz + 8 kHz ±50 ppm, 2.048 MHz ±50 ppm, 1.544 MHz ±50 ppm, 2.048 Mbit/s ±50 ppm, 1.544 Mbit/s ±50 ppm Interface 2M: ITU-T G.703 Table 10, HDB3 1.5M: B8ZS, AMI ANSI T1.403 Level (64k): 0.63 to 1.1 Vo-p Code (64k): AMI with 8 kHz violation Connector BNC (75 Ω): 2 MHz, 2 Mbit/s Siemens (120 Ω, balanced): 2 MHz, 2 Mbit/s, 64 kHz + 8 kHz Bantam (100 Ω, balanced): 1.5 MHz, 1.5 Mbit/s
Trigger output	Level: TTL (active high), impedance: 75 Ω (BNC)
Trigger input	Usable as capture buffer trigger Level: TTL (Active high), connector: 75 Ω (BNC)
Sync I/O	MD1230A time sync signal, impedance: 75 Ω (BNC)
Interfaces	RS-232C, GPIB (Option 02), Ethernet (10BASE-T/100BASE-TX), USB port x 2, PS/2 keyboard connector, GPS antenna (option 05), video output (VGA)
Built-in memory	Measurement conditions: 10 sets, Measurement results: 10 sets
External storage	3.5" FDD
OS	Windows® 98 Second Edition
Auto test	RFC2544 Tests (throughput, latency, frame loss rate, back-to-back frame, system recovery, reset)
Traffic monitor	Ethernet frame count for max. 64 flow, IP packet count for max. 64 flow, frame count for each protocol
Traffic map	Ethernet data flow for max. 64 flow, IP data flow for max. 64 flow
LEDs	Power fail, errors, alarms, remote, local, HDD, power
Dimensions and mass	320 (W) x 177 (H) x 350 (D) mm, ≤15 kg (excluding options and modules)
Power supply	85 to 132 Vac/170 to 250 Vac (auto switching), 47.5 to 63 Hz, ≤530 VA
Relative humidity	0° to +40°C (except when HDD or FDD are active.)
EMC	EN61326: 1997/A1: 1998 (Class A), EN61000-3-2: 1995/A2: 1998 (Class A), EN61326: 1997/A1: 1998 (Annex A)
LVD	EN61010-1: 1993/A2: 1995 (Installation Category II, Pollution degree 2)

• Ethernet Module

Model	MU120101A	MU120102A
Ports	10BASE-T/100BASE-TX Number of ports: 8 Connector: RJ-45 Link speed: 10/100 Mbit/s Duplex mode: Full, half Auto negotiation: On/off Flow control: On/off	1000BASE-SX/LX/LH/ZX*1 Number of ports: 2 Connector: SC Link speed: 1000 Mbit/s Duplex mode: Full Auto negotiation: On/off Flow control: On/off
LEDs	Link, Tx/collision, Rx/error	Link, Tx, Rx/error
Frame settings	MAC address: Fixed, increment, decrement, random (changeable parts specified in nibble units) VLAN tag*2: Fixed, increment, decrement, random MPLS label*2: Up to 10 MPLS labels can be appended. Fixed setting Protocol editing: IPv4, IPv6, TCP, UDP, IGMP, ICMPv4, RIP, DHCP, IPX, ARP, pause control Data field: Can set any 4 parts in data field All 1s, all 0s, alternate 1/0 (each bit, each 2 bits, each nibble, each byte, each 2 bytes), increment, decrement, random, user programmed, single PRBS9, time stamp, sequence number, test frame	
Frame length	18 to 10,000 bytes (settable as auto, fixed, increment, or random)	48 bytes to 64 kbytes (settable as auto, fixed, increment, or random)
Stream settings	Stream transport mode: Continuous, continuous burst, stop after this stream, next stream, jump to stream. Jump to stream for count (loop count: 1 to 16000000, frame count per burst: 1 to 16000000, burst count per stream: 1 to 16000000)	
Stream settings	Inter frame gap 10BASE-T: 8000 ns to 170 s, resolution at 800 ns, settable as fixed, random 100BASE-TX: 800 ns to 170 s, resolution at 80 ns, settable as fixed Inter burst gap 10BASE-T: 8000 ns to 170 s, resolution at 800 ns, settable as fixed 100BASE-TX: 800 ns to 170 s, resolution at 80 ns, settable as fixed Inter stream gap 10BASE-T: 8000 ns to 170 s, resolution at 800 ns, settable as fixed 100BASE-TX: 800 ns to 170 s, resolution fixed at 80 ns, settable as fixed	Inter frame gap: 64 ns to 120 s, resolution at 16 ns, settable as fixed, random Inter burst gap: 64 ns to 120 s, resolution at 16 ns, settable as fixed Inter stream gap: 64 ns to 120 s, resolution at 16 ns, settable as fixed
Number of stream	256 streams/port	
Error insertion	Collision, FCS error, dribble bit error, undersize error, oversize error, fragments error, oversize/FCS error, IP header checksum error, TCP/UDP header checksum error	FCS error, undersize error, oversize error, fragments error, oversize/FCS error, IP header checksum error, TCP/UDP header checksum error
Counter	Transmitted frame, received frame, transmitted bytes, received bytes, fragments, undersize, oversize, oversize/bad CRC, FCS error, line error, flow control, alignment error, dribble bit error, collision, capture trigger, capture filter, transmitted ARP reply, transmitted ARP request, transmitted ping reply, transmitted ping request, received ARP reply, received ARP request, received ping reply, received ping request, QoS 0 to 7, user defined 1, user defined 2, transmitted IP, received IP, IP checksum error, TCP checksum error, UDP checksum error	Transmitted frame, received frame, transmitted bytes, received bytes, fragments, undersize, oversize, oversize/bad CRC, FCS error, line error, flow control, byte alignment error, capture trigger, capture filter, transmitted ARP reply, transmitted ARP request, transmitted ping reply, transmitted ping request, received ARP reply, received ARP request, received ping reply, received ping request, QoS 0 to 7, user defined 1, user defined 2, transmitted IP, received IP, IP checksum error, TCP checksum error, UDP checksum error
Latency	Maximum, minimum, average measure	
Frame arrival time variation measurement	Time resolution: 1 μs, 10 μs, 100 μs, 1 ms, 10 ms, 100 ms, 1 s	
QoS counter setting	Using QoS described below, 8-level priority frame count: IEEE802.1D VLAN tag user priority field, least 3 bits of RFC2474 DSCP field	
Capture buffer	8 Mbytes/port	32 Mbytes/port
Capture filter	At following conditions for each port, capture filter condition settings: Destination MAC address, source MAC address, 32-bit pattern (settable bit length and offset) x 2, error conditions	
Capture trigger	At following conditions for each port, capture trigger condition settings: Destination MAC address, source MAC address, 32-bit pattern (settable bit length and offset) x 2, error conditions, traffic over, latency over, external trigger input	
Protocol decode	Ethernet, MPLS, VLAN, ARP, IPX, IPv4, ICMP, IPv6, TCP, UDP, IGMP, RIP, BGP4, DHCP	
Protocol emulate	ARP, PING, IGMP, BGP4	

*1: 1000BASE-SX/LX/LH/ZX can be chosen by exchanging GBIC that is a optional accessories.

*2: Both VLAN tag and MPLS labels can not be used simultaneously.

• POS Module

Model	MU120103A	MU120104A	MU120105A	MU120106A
Ports	OC-48/STM-16 Wavelength: 1260 to 1360 nm Number of port: 1 Connector: SC Bit rate: 2488.320 Mbit/s (NRZ) Output level: -5 to 0 dBm Input sensitivity: -18 to 0 dBm	OC-48/STM-16 Wavelength: 1500 to 1580 nm Number of port: 1 Connector: SC Bit rate: 2488.320 Mbit/s (NRZ) Output level: -1.0 to +2.0 dBm Input sensitivity: -28 to -9 dBm	OC-192/STM-64 Wavelength: 1290 to 1330 nm Number of port: 1 Connector: SC Bit rate: 9953.280 Mbit/s (NRZ) Output level: -6 to 0 dBm Input sensitivity: -11 to -1.0 dBm	OC-192/STM-64 Wavelength: 1530 to 1565 nm Number of port: 1 Connector: SC Bit rate: 9953.280 Mbit/s (NRZ) Output level: -1.0 to +2.0 dBm Input sensitivity: -14 to -3.0 dBm
LEDs	Link, Tx, Rx/error, optical send			
Clocks	Internal (MU120103A/120104A : ±50 ppm variable, MU120105A/120106A : ±100 ppm), receive signal, lock (64 kHz + 8 kHz, 1.5 MHz, 2 MHz, 1.5 Mbit/s, 2 Mbit/s)			
SDH/SONET settings	Frame: SDH/SONET Alarm addition: LOS, LOF, MS-AIS, MS-RDI, MS-TIM, AU-AIS, AU-LOP, HP-SLM, HP-TIM, HP-RDI, HP-UNEQ Timing: Single, single burst frame, alternative [alarm frame (0 to 8000), Normal frame (0 to 8000)], all Error insertion: FAS, bits all, B1, B2, B3, MS-REI, HP-REI Timing: Single, single burst bit (1 to 64000), rate (1E-3, 1E-4, 1E-5, 1E-6, 1E-7, 1E-8, 1E-9), programmed rate [AE-B *A: 1.0 to 9.9 (0.1 steps), B: 3 to 10] APS (K1/K2) Sequence generation: 2 to 64 words, repeat (8000 frames)			
Mapping				
Frame settings	PPP scramble: On/off PPP FCS: CRC32 MPLS label: Up to 10 MPLS labels can be appended. Fixed setting Protocol editing: IPv4, IPv6, TCP, UDP, IGMP, ICMPv4, RIP, DHCP Data field: Can set any 4 parts in data field. All 1s, all 0s, alternate 1/0 (each bit, each 2 bits, each nibble, each byte, each 2 bytes), increment, decrement, random, user programmable, single PRBS9, time stamp, sequence number, test frame			
Frame length	8 bytes to 64 kbytes (settable as auto, fixed, increment, or random)			
Stream settings	Stream transport mode: Continuous, continuous burst, stop after this stream, next stream, jump to stream. Jump to stream for count (loop count: 1 to 16000000, frame count per burst: 1 to 16000000, burst count per stream: 1 to 16000000)			
	Inter frame gap: 3.2 ns to 120 s, resolution at 3.2 ns, settable as fixed, random Inter burst gap: 3.2 ns to 120 s, resolution at 3.2 ns, settable as fixed Inter stream gap: 3.2 ns to 120 s, resolution at 3.2 ns, settable as fixed		Inter frame gap: 0.8 ns to 120 s, resolution at 0.8 ns, settable as fixed, random Inter burst gap: 0.8 ns to 120 s, resolution at 0.8 ns, settable as fixed Inter stream gap: 0.8 ns to 120 s, resolution at 0.8 ns, settable as fixed	
Number of streams	256 streams/port			
Error insertion	FCS error, abort frame, fragment, undersize, IP header checksum error, TCP/UDP header checksum error			
Counter	SONET/SDH: B1, B2, B3, HP-IEC, MS-REI, HP-REI, LOS, LOF, OOF, MS-AIS, MS-RDI, AU-AIS, AU-LOP, HP-SLM, HP-TIM, HP-RDI, HP-UNEQ Justification: NDF, +PJC, -PJC PPP/IP/TCP/UDP: Transmitted frame, received frame, transmitted bytes, received bytes, received bytes before stuffing, transmitted bytes after stuffing, fragment, undersize, oversize, FCS error, abort error, capture trigger, capture filter, transmitted ping reply, transmitted ping request, received ping reply, received ping request, QoS 0 to 7, user defined 1, user defined 2, transmitted IP, received IP, IP checksum error, TCP checksum error, UDP checksum error			
Latency	Maximum, minimum, average			
Alarm arrival time variation measurement	Time resolution: 1 µs, 10 µs, 100 µs, 1 ms, 10 ms, 100 ms, 1 s			
QoS counter settings	Using least 3 bits of RFC2474 DSCP field, 8-stage priority packet count			
Capture buffer	64 Mbytes		256 Mbytes	
Capture filter	At following conditions for each port, capture filter condition settings: Destination IP address, source IP address, 32-bit pattern (settable bit length and offset) x 2, error conditions			
Capture trigger	At following conditions for each port, capture trigger condition settings: Destination IP address, source IP address, 32-bit pattern (settable bit length and offset) x 2, error conditions, traffic over, latency over, external trigger input			
Protocol decode	PPP, LCP, IPCP, MPLS, IPv4, ICMPv4, IPv6, TCP, UDP, IGMP, RIP, BGP4, DHCP			
Protocol emulate	PING, IGMP, BGP4			

Ordering information

Please specify model/order number, name and quantity when ordering.

Model/Order No.	Name
MD1230A	Main frame Data Quality Analyzer
	Standard accessories
	Power cord, 2.5 m: 1 pc
F0079	Fuse, 10 A: 2 pcs
B0329G	Front cover (for 3/4MW4U): 1 pc
B0500A	Side cover: 1 pc
W1930AE	MD1230A operation manual (CD-ROM)*1: 1 pc
	Options
MD1230A-01	RS-232C control
MD1230A-02	GPIB control
MD1230A-03	Ethernet control
MD1230A-05	GPS module
	Software
MX123001A	Data Quality Analyzer Control Software
	Plug-in modules
MU120101A	10M/100M Ethernet Module
MU120102A	Gigabit Ethernet Module*2
MU120103A	2.5G (1.31) Module
MU120104A	2.5G (1.55) Module
MU120105A	10G (1.31) Module
MU120106A	10G (1.55) Module
	Maintenance service*3
MD1230A-90	Extension service 3 years
MU120101A-90	Extension service 3 years
MU120102A-90	Extension service 3 years
MU120103A-90	Extension service 3 years
MU120104A-90	Extension service 3 years
MU120105A-90	Extension service 3 years
MU120106A-90	Extension service 3 years
	Optional accessories
G0105A	GBIC SX 850 nm*4
G0106A	GBIC LX 1310 nm*4
G0107A	GBIC LH 1310 nm*4
G0108A	GBIC ZX 1550 nm*4
J0788B	Optical fiber cord (SM, SC-SC connector both ends), 2 m
J0773B	Optical fiber cord (GI, SC-SC connector both ends), 2 m
J1119B	Optical fiber cable (duplex, MM), 2 m
J1110B	LAN cable (straight, 5 m)
J1109B	LAN cable (cross, 5 m)
J0755D	Coaxial cord (BNC-P620 - 3C-2WS - BNC-P620, 75 Ω), 2 m
J0162B	Balanced cable (Siemens 3p-Siemens 3p), 2 m
J0845A	Balanced cable (BANTAM 3P/BANTAM 3P), 6 ft
J0008	GPIB cable, 2 m
B0448	Soft case
B0336C	Carrying case (for 3/4MW4U, 350D)
Z0321A	Keyboard (PS/2)
Z0541A	Mouse
J0149A	Fixed optical attenuator (SC, 5 dB)
J0149B	Fixed optical attenuator (SC, 10 dB)
J0149C	Fixed optical attenuator (SC, 15 dB)
B0501B	Blank panel
W1927AE	MD1230A operation manual
W1929AE	MD1230A remote control operation manual
W1928AE	MX123001A software operation manual

*1: Includes W1927AE, W1928AE and W1929AE operation manuals. Printed version sold separately.

*2: MU120102A requires two GBIC modules (sold separately).

*3: Please ask your local Anritsu Field Office or Sales Representative for price and availability.

*4: GBIC module is sold per one piece. MU120102A has two GBIC interface.

ATM QUALITY ANALYZER
MP1220B

1.5 Mbps (T1) to 622 Mbps (STM-4c/OC-12c)

For Construction and Maintenance of ATM Networks



The MP1220B is a portable measuring instrument for ATM networks; it can measure the PDH/SDH physical layer, the ATM layer, and the AAL. It is the perfect instrument for troubleshooting ATM networks during construction and maintenance and has a wide range of convenient applications in manufacturing inspection of ATM devices.

Features

- Supports various interfaces from 1.5 Mbps (T1) to 622 Mbps (STM-4c/OC-12c) SONET and SDH
- Simultaneous measurement and real-time analysis up to the ATM-CPCS layer of two channels(up/down stream)
- Automated traffic monitoring of 1,023 network channels for bandwidth utilization
- Uses formatted payload data conforming to ITU-O.191 recommendations for cell delay performance measurements
- Small, lightweight, rack mount or portable
- Supports a variety of remote control testing configurations
- Online manuals and online help

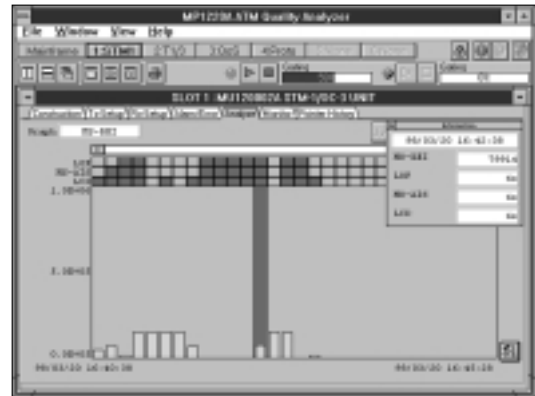

Graphical display of alarm/error history



Measurement items for test cells

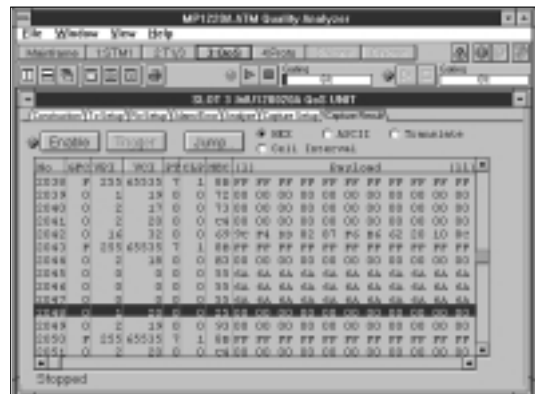

Cell capture display (hexadecimal)

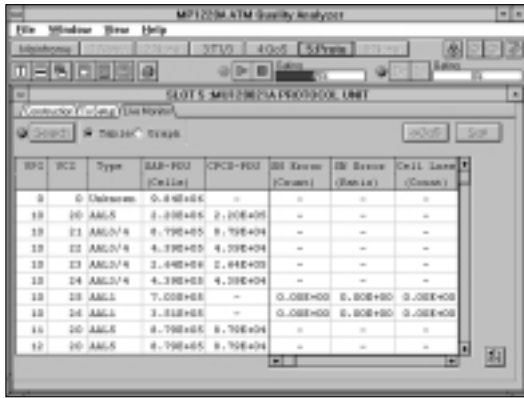

Automatic evaluation and measurement of AAL type for 1023 channels

Specifications

• MP120B ATM Quality Analyzer

Display	10.4 inch TFT color LCD with touch panel (analog resistive membrane)
Memory storage	3.5 inch floppy disk drive (1.44 MB/720 KB) and hard disk drive (≥500 MB)
Buzzer	Alarm, error
External interface	RS-232C (D-sub 9-pin), printer (Centronics, D-sub, 25-pin), keyboard (PS/2, mini-DIN, 6-pin), mouse (PS/2, mini-DIN, 6-pin), VGA (analog RGB, D-sub, 15-pin)
Slots	6 (two channels max.)
EMC	EN55011: 1991, Group 1, Class A EN50082-1: 1992 Harmonic current emissions; EN61000-3-2: 1995, Class D
Safety	EN61010-1: 1993 (Installation Category II, Pollution Degree II)
Dimensions and mass	284 (W) x 221.5 (H) x 365 (D) mm, ≤12 kg (excluding units)
Power supply	100 to 120/200 to 240 Vac (autoswitching), 50 to 60 Hz, ≤300 VA
Operating range	Operating: 5° to 50° C (excluding FDD), Storage: -20° to 60° C

• MU120001A STM-4/OC-12 Unit

Bit rate	51.84, 155.52, 622.08 Mbps
Frames	SDH/SONET
Output signal	Connector: FC (replaceable), 1.31 μm band (SM) Clock: Internal (±10 ppm), external, receive Level: -15 to -8 dBm Code: NRZ Optical safety: IEC825-1 Class 1, 21CFR1040.10 Class I
Input signal	Connector: FC (replaceable), 1.31 μm band (SM) Frequency range: ±100 ppm Level: -34 to -8 dBm (51.84 Mbps, 155.52 Mbps), -28 to -8 dBm (622.08 Mbps) Code: NRZ
Functions	SOH/POH setting, SOH/POH monitoring, path trace, empty cell setting, cell scramble (de-scramble) on/off, coset on/off, HEC error correction on/off Error addition: Bit, B1, B2, B3, FEBE-L, FEBE-P, cell Alarm addition: LOS, LOF, AIS-L, RDI-L, AIS-P, RDI-P, LCD Error measurement: B1, B2, B3, MS-REI (FEBE-L), HP-REI (FEBE-P), HEC corrected cells, HEC uncorrected cells Alarm measurement: LOS, OOF, LOF, MS-AIS (AIS-L), MS-RDI (RDI-L), AU-AIS (AIS-P), HP-RDI (RDI-P), AU-LOP (LOP-P), LCD Pointers: Monitor, justification, NDF Auxiliary output: Receive clock output, trigger output

• MU120002A STM-1/OC-3 Unit

Bit rate	155.52 Mbps
Frames	SDH/SONET
Output signal	Connector Optical: SC 1.31 μm (SM); Electrical: BNC 75 Ω Clock: Internal (±10 ppm), external, receive Optical level: -15 to -8 dBm Electrical level: 1 ±0.1 Vp-p (CMI) Code Optical: NRZ, Electrical: CMI Optical safety: IEC825-1 Class 1, 21CFR1040.10 Class I

Continued on next page

Input signal	<p>Connector Optical: SC 1.31 μm (SM/MM); Electrical: BNC 75 Ω Frequency range: ± 100 ppm Optical level: -28 to -8 dBm (SM) Electrical level: 1 ± 0.1 Vp-p (CMI) *Cable loss: 0 to 12 dB, Monitor: 20 dB attenuated level of above level can be applied. Code Optical: NRZ; Electrical: CMI</p>
Functions	<p>SOH/POH setting, SOH/POH monitoring, path trace, empty cell setting, cell scramble (de-scramble) on/off, coset on/off, HEC error correction on/off Error addition: Bit, B1, B2, B3, FEBE-L, FEBE-P, cell Alarm addition: LOS, LOF, AIS-L, RDI-L, AIS-P, RDI-P, LOP-P, LCD Error measurement: B1, B2, B3, MS-REI (FEBE-L), HP-REI (FEBE-P), HEC corrected cells, HEC uncorrected cells Alarm measurement: LOS, OOF, LOF, MS-AIS (AIS-L), MS-RDI (RDI-L), AU-AIS (AIS-P), HP-RDI (RDI-P), AU-LOP (LOP-P), LCD Pointers: Monitor, \pmjustification, NDF, history record Auxiliary output: Receive clock output, trigger output</p>

• MU120010A T1/T3 Unit

Bit rate	1.544 Mbps (T1), 44.736 Mbps (T3)
Frames	1.5M ESF (PLCP: on/off), 45M C-bit parity (PLCP: on/off), 45M M23 (PLCP: on/off)
Output signal	<p>Connector BNC: 75 Ω unbalanced (T3); 8-pin modular: 100 Ω balanced (ISO/IEC 10173, T1) Clock: Internal (± 10 ppm), external, receive Level: 2.4 to 3.6 Vo-p (T1), 0.36 to 0.85 Vo-p (T3) Code T1: B8ZS, T3: B3ZS</p>
Input signal	<p>Connector BNC: 75 Ω unbalanced (T3); 8-pin modular: 100 Ω balanced (ISO/IEC 10173, T1) Frequency range: ± 130 ppm (T1), ± 20 ppm (T3) Level: 2.4 to 3.6 Vo-p (T1), 0.36 to 0.85 Vo-p (T3) *Monitor: 20 dB attenuated level of above level can be applied. Code T1: B8ZS, T3: B3ZS</p>
Functions	<p>Empty cell setting, cell scramble (de-scramble) on/off, coset on/off, HEC error correction on/off Error addition: Bit, FEBE, PLCP-BIP-8, PLCP-FEBE, cell Alarm addition: LOF, LOS, AIS, yellow, idle, PLCP-LOF, PLCP-yellow, LCD Error measurement: Code, CP, FEBE, CRC6, PLCP-BIP-8, PLCP-FEBE, HEC corrected cells, HEC uncorrected cells Alarm measurement: LOS, OOF, AIS, yellow, idle, PLCP-OOF, PLCP-yellow, LCD Auxiliary output: Receive clock output, trigger output</p>

• MU120011A E1/E3/E4 Unit

Bit rate	2.048 Mbps (E1), 34.368 Mbps (E3), 139.264 Mbps (E4)
Frames	2M-CRC-4 off (PLCP: on/off), 2M CRC4 on (PLCP: on/off), 34M G.751 (PLCP: on), 34M GH.832 (PLCP: off), 139M G.832 (PLCP: off)
Output signal	<p>Connector D-sub (9-pin): 120 Ω balanced (E1); BNC: 75 Ω unbalanced (E1/E3/E4) Clock: Internal (± 10 ppm), external, receive Level: 3 ± 0.3 Vo-p (E1 balanced), 2.37 ± 0.237 Vo-p (E1 unbalanced), 1 ± 0.1 Vo-p (E3), 1 ± 0.1 Vp-p (E4) Code E1/E3: HDB3, E4: CMI</p>
Input signal	<p>Connector D-sub (9-pin): 120 Ω balanced (E1); BNC: 75 Ω unbalanced (E1/E3/E4) Frequency range: ± 100 ppm (E1/E4), ± 20 ppm (E3) Level: 3 ± 0.3 Vo-p (E1 balanced), 2.37 ± 0.237 Vo-p (E1 unbalanced), 1 ± 0.1 Vo-p (E3), 1 ± 0.1 Vp-p (E4) *Cable loss: 0 to 6 dB (E1), 0 to 12 dB (E3, E4), Monitor: 20 dB attenuated level of above level can be applied. Code E1/E3: HDB3, E4: CMI</p>
Functions	<p>Empty cell setting, cell scramble (de-scramble) on/off, coset on/off, HEC error correction on/off (E1, E3) Error addition: Bit, BIP-8, REI, PLCP-BIP-8, PLCP-FEBE, cell Alarm addition: LOF, LOS, AIS, RA, RA (MF), RDI, PLCP-LOF, PLCP-yellow, LCD Error measurement: CRC4, code, BIP-8, REI, PLCP-BIP-8, PLCP-FEBE, HEC corrected cells, HEC uncorrected cells Alarm measurement: LOS, OOF, AIS, MF loss (CRC), MF loss (sig), RA, RA (MF), RDI, PLCP-OOF, PLCP-yellow, LCD Trail trace: Monitor, setting Auxiliary output: Receive clock output, trigger output</p>

• MU120012A E1/E3 Unit

Bit rate	2.048 Mbps (E1), 34.368 Mbps (E3)
Frames	2M-CRC-4 off (PLCP: on/off), 2M CRC4 on (PLCP: on/off), 34M G.751 (PLCP: on), 34M G.832 (PLCP: off)
Output signal	<p>Connector D-sub (9-pin): 120 Ω balanced (E1); BNC: 75 Ω unbalanced (E1/E3) Clock: Internal (± 10 ppm), external, receive Level: 3 ± 0.3 Vo-p (E1 balanced), 2.37 ± 0.237 Vo-p (E1 unbalanced), 1 ± 0.1 Vo-p (E3) Code: HDB3</p>

Continued on next page

Input signal	<p>Connector D-sub (9-pin): 120 Ω balanced (E1); BNC: 75 Ω unbalanced (E1/E3) Frequency range: ±100 ppm (E1), ±20 ppm (E3) Level: 3 ±0.3 Vo-p (E1 balanced), 2.37 ±0.237 Vo-p (E1 unbalanced), 1 ±0.1 Vo-p (E3) *Cable loss: 0 to 6 dB (E1), 0 to 12 dB (E3), Monitor: 20 dB attenuated level of above level can be applied. Code: HDB3</p>
Functions	<p>Empty cell setting, cell scramble (de-scramble) on/off, coset on/off, HEC error correction on/off Error addition: Bit, BIP-8, REI, PLCP-BIP-8, PLCP-FEBE, cell Alarm addition: LOF, LOS, AIS, RA, RA (MF), RDI, PLCP-LOF, PLCP-yellow, LCD Error measurement: CRC4, code, BIP-8, REI, PLCP-BIP-8, PLCP-FEBE, HEC corrected cells, HEC uncorrected cells Alarm measurement: LOS, OOF, AIS, MF Loss (CRC), MF Loss (Sig), RA, RA (MF), RDI, PLCP-OOF, PLCP-yellow, LCD Trail trace: Monitor, setting Auxiliary output: Receive clock output, trigger output</p>

• **MU120015A ATM25M Unit**

Bit rate	32.00 Mbps (25M)
Output signal	<p>Connector: 8-pin modular jack, 100 Ω (RJ45) Clock: Internal (±10 ppm), external, receive Level: 2.7 to 3.4 Vp-p (1 symbol) Code: NRZI (4B/5B)</p>
Input signal	<p>Connector: 8-pin modular jack, 100 Ω (RJ45); Frequency: ±100 ppm; Level: 2.7 to 3.4 Vp-p (1 symbol); Code: NRZI (4B/5B)</p>
Functions	<p>Empty cell setting, coset on/off Error addition: Code, cell Alarm addition: LOS Error measurement: Code, HEC uncorrected cell, illegal cell Alarm measurement: LOS Sync event: Send, measure Auxiliary output: Receive clock output, trigger output</p>

• **MU120016A 6.3M Unit**

Bit rate	6.312 Mbps (6.3M)
Output signal	<p>Connector: BNC, 75 Ω Clock: Internal (±10 ppm), external, receive Level: 2 ±0.3 Vo-p Code: B8ZS</p>
Input signal	<p>Connector: BNC, 75 Ω Frequency: ±30 ppm Level: 2 ±0.3 Vo-p *Cable loss: 0 to 6 dB, Monitor: 20 dB attenuated level of above level can be applied. Code: B8ZS</p>
Functions	<p>Empty cell setting, cell scramble (de-scramble) on/off, coset on/off, HEC error correction on/off Error addition: Bit, CRC5, cell Alarm addition: LOS, AIS, RAI, LOF, LCD Error measurement: CRC5, HEC corrected cell, HEC uncorrected cell Alarm measurement: LOS, AIS, RAI, LOF, LCD Auxiliary output: Receive clock output, trigger output</p>

• **MU120017A 6.3/25M Unit**

Bit rate	6.312 Mbps (6.3M), 32.00 Mbps (25M)
Output signal	<p>Connector BNC: 75 Ω (6.3M); 8-pin modular jack, 100 Ω (RJ45, 25M) Clock: Internal (±10 ppm), external, receive Level: 2 ±0.3 Vo-p (6.3M), 2.7 to 3.4 Vp-p (25M, 1 symbol) Code 6.3M: B8ZS, 25M: NRZI (4B/5B)</p>
Input signal	<p>Connector BNC: 75 Ω (6.3M); 8-pin modular jack, 100 Ω (RJ45, 25M) Frequency range: ±30 ppm (6.3M), ±100 ppm (25M) Level: 2 ±0.3 Vo-p (6.3M), 2.7 to 3.4 Vp-p (25M, 1 symbol) *Cable loss: 0 to 6 dB (6.3M), Monitor: 20 dB attenuated level of above level can be applied (6.3M). Code 6.3M: B8ZS, 25M: NRZI (4B/5B)</p>
Functions	<p>Empty cell setting, cell scramble (de-scramble) on/off (6.3M only), coset on/off, HEC error correction on/off (6.3M only), sync event send (25M only) Error addition 6.3M: Bit, CRC5, cell 25M: Code, cell Alarm addition 6.3M: LOS, AIS, RAI, LOF, LCD 25M: LOS Error measurement 6.3M: CRC5, HEC corrected cell, HEC uncorrected cell 25M: Code, HEC uncorrected cell, illegal cell Alarm measurement 6.3M: LOS, AIS, RAI, LOF, LCD 25M: LOS Sync event (25M only): Send, measure Auxiliary output: Receive clock output, trigger output</p>

• MU120020A QoS Unit

Foreground cells (test cells)	O.191, extended O.191, OAM test cell (PRBS 15), null, AAL1, AAL3/4, (For null, AAL1, AAL3/4, next pattern settable to payload. PRBS 9, PRBS 15, PRBS 15 (non-inverted), PRBS 23, time stamp, programmable)
Cell generation timing	CBR, burst, sawtooth waveform, CBR with CDV, VBR, Poisson distribution, manual, external edge, external level, detailed CBR, burst for UPC measurement, programmable
Background cell	CBR (10 types)
OAM cell	AIS, RDI, continuity check, loopback, programmable, forward monitoring, backward reporting, PM activation/deactivation, CC activation/deactivation
Capture	Capacity: 4095 cells Filter: All cells, specified cells, header +first byte of payload match/mismatch cells Trigger: Manual, OAM cell receive, cell error detect, cell loss detect, cell misinsertion detect, cell tagging, external input signal, etc. Display: Hexadecimal, ASCII, cell interval, translate
Single-channel	Error addition: Cell loss, cell error Error detection: Bit error, error cell, cell loss, cell misinsertion, non-conforming cell, etc. (measurement items differ according to test cell) Alarm detection: VP-AIS, VP-RDI, VP-LOC, VC-AIS, VC-RDI, VC-LOC Others: Bandwidth, total cells, cell delay measurement, 1 point CDV measurement, 2 point CDV measurement, cell interval measurement
1023 channel measurement (live monitor)	Detect and measure 1023 channels on line Measurement items: Total cell count, CLP = 0 cell count, CLP = 1 cell count, OAM cell count
Auxiliary input	Trigger input

• MU120021A Protocol Unit

Send/receive memory	8 MB (≥130,000 cells, send: 8 MB, receive: 8 MB, send + receive: 4 + 4 MB selectable)
Cell send	Transmit from memory according to time stamp. Able to transmit in every 1 cell. Able to edit AAL1, AAL3/4, AAL5 frame
Capture	Capacity: ≥130,000 cells (at 8 MB receive setting) Filter: All cells, all cells (excluding idle cells), up to 16 specified channels Trigger: Specified event, specified event occurrence times, sequential event (second event after first event) Event: Specified channel, SN abnormality, ST abnormality, CRC abnormality, specified pattern, external input signal, etc. Display: Cell, SAR, CPCS, time stamp
Single-channel measurement	AAL type automatic evaluation and measurement Error addition: Cell loss, cell error Measurement items: Cell count, CPCS-PDU count, assembled timer timeout PDU count, frame size error count, CPI error count, SN error count, ST error count, LI error count, about count, BE tag error count, BA size error count, AL error count, length error count, CRC error count, etc. (measurement items differ according to AAL type)
1023 channel measurement (live monitor)	Detect and measure 1023 channels on line. AAL type automatically detected and measured Measurement items: Cell count, CPCS count, etc. (measurement items differ according to AAL type)
External interface	Trigger input (capture event)

• MX122020A Protocol Decoding Software

Supported protocols	ATM (ITU-T I.361), OAM (ITU-T I.610), AAL5-CPCS (ITU-T I.363), SSCOP (ITU-T Q.2110), UNI 3.1/4.0 (ATM forum), LLC (RFC2225), SNAP (RFC2225), ATMARP/InATMARP (RFC2225), IP (RFC791), ICMP (RFC792), UDP (RFC768), TCP (RFC793)
Decoded file type	Data captured by MU120021A Protocol Unit and saved in binary format
Operating environment	MP1220B or a PC running with Windows 3.1/95/98

Ordering information

Please specify model/order number, name, and quantity when ordering.

Model/Order No.	Name
MP1220B	Mainframe ATM Quality Analyzer
	Standard accessories
	AC power cord: 1 pc
F0012	Fuse, 3.15 A: 2 pcs
W1304AE	MP1220B operation manual: 1 copy
W1305AE	MP1220B remote control operation manual: 1 copy
Z0339	Software recovery floppy disk*1: 1 pc
Z0340B	Protective cover (without keyboard): 1 pc
Z0343A	Input pen: 1 pc
Z0345A	Accessory bag: 1 pc
	Options
MP1220B-01	RS-232C control
MP1220B-02	GPIB control
MP1220B-03	Ethernet control
MU120001A-38	ST connector
MU120001A-39	DIN connector
MU120001A-40	SC connector
MU120001A-43	HMS-10/A connector
	Units
MU120001A	STM-4/OC-12 Unit
W1308AE	MU120001A operation manual
W1314AE	MU120001A remote control operation manual
MU120002A	STM-1/OC-3 Unit
W1309AE	MU120002A operation manual
W1315AE	MU120002A remote control operation manual
MU120010A	T1/T3 Unit
W1310AE	MU120010A operation manual
W1316AE	MU120010A remote control operation manual
MU120011A	E1/E3/E4 Unit
W1311AE	MU120011A/120012A operation manual
W1317AE	MU120011A/120012A remote control operation manual
MU120012A	E1/E3 Unit
W1311AE	MU120011A/120012A operation manual
W1317AE	MU120011A/120012A remote control operation manual

*1: Sold only to MP1220B users

Note: Please consult our sales department about adding the VBR functions to your MP1220B.

Windows is a registered trademark of Microsoft Corporation.

Model/Order No.	Name
MU120015A	ATM25M Unit
W1312AE	MU120015A/120016A/120017A operation manual
W1318AE	MU120015A/120016A/120017A remote control operation manual
MU120016A	6.3M Unit
W1312AE	MU120015A/120016A/120017A operation manual
W1318AE	MU120015A/120016A/120017A remote control operation manual
MU120017A	6.3/25M Unit
W1312AE	MU120015A/120016A/120017A operation manual
W1318AE	MU120015A/120016A/120017A remote control operation manual
MU120020A	QoS Unit
W1313AE	MU120020A operation manual
W1319AE	MU120020A remote control operation manual
MU120021A	Protocol Unit
W1371AE	MU120021A operation manual
W1372AE	MU120021A remote control operation manual
	Application software
MX122020A	Protocol Decoding Software
W1648AE	MX122020A operation manual
	Optional accessories
J0008	GPIB cable, 2 m
J0775D	Coaxial cord, 2 m (75 Ω)
J0776D	BNC cord, 2 m (twin shield)
J0635B	Optical fiber cord (FC/PC-FC/PC-2m-SM), 2 m
J0660B	Optical fiber cord (SC/PC-SC/PC-2m-SM), 2 m
J0796A	Replaceable optical connector (ST)
J0796B	Replaceable optical connector (DIN)
J0796C	Replaceable optical connector (SC)
J0796D	Replaceable optical connector (HMS-10/A)
J0796E	Replaceable optical connector (FC)
J0844A	ISO 10173 cable (T1), 2 m
J0838A	UTP category 3 cable (25M), 2 m
Z0319A	PS/2 mouse
Z0340A	Protective cover (with keyboard)
Z0340B	Protective cover (without keyboard)
B0414A	Hard case
B0163	Soft case

PCM CHANNEL ANALYZER MS371A/A1

For Simultaneous Measurement of 30 Channels with MS120A

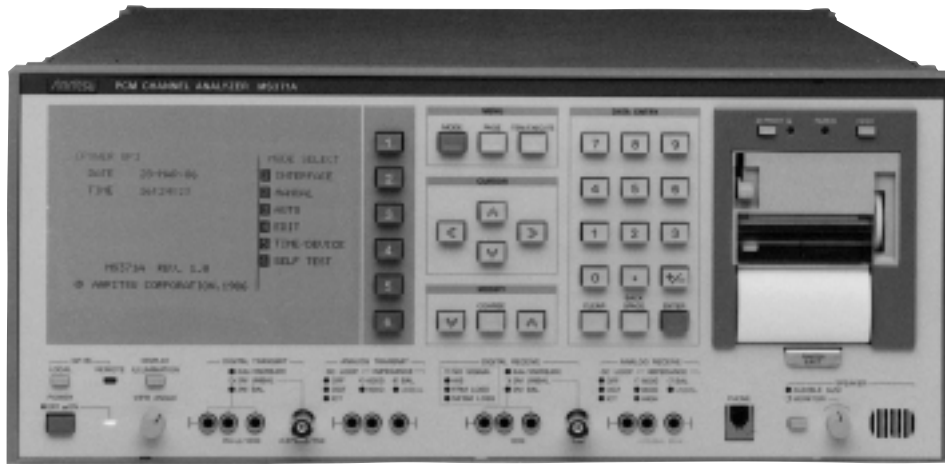

CE
(MS371A1) GPIB

The MS371A/A1 is an overall measuring instrument with many measuring functions for digital primary hierarchy transmission. It can be used to measure (1) voice encode/decode performance characteristics, (2) frame alignment/alarm test, (3) bit, code, and frame errors, (4) timing jitter, and (5) signalling, etc.

The primary hierarchy (PCM) digital transmission system has been commonly used as the foundation for ISDNs. Therefore, there are many existing equipment and transmission channels to be maintained. The necessary measurements are diverse and much time and labor is needed to evaluate them when commissioning and maintaining transmission circuits and equipment. The increasing number of PCM systems has made improved measurement evaluation efficiency a necessity.

The Anritsu MS371A/A1 has most of the functions required to measure PCM systems. It is an all-purpose measuring instrument designed to improve measurement efficiency. Measurements of PCM voice encode/decode performance require much time and labor. The MS371A/A1 stores the measurement sequence and parameters in its internal memory and makes automatic measurements to markedly improve efficiency. It has a GPIB control function, which with the MS120A Channel Selector permits measurement of 30 channels in one sequence. It also compares the measured results to a reference value, judges them, and displays GOOD or NO GOOD automatically. The measured results can then be printed out on the built-in printer. Another special feature is that the report of the measured results can also be printed out an external printer.

In conventional measuring systems, the results are edited by a personal computer or some other external device. However, the MS371A/A1 performs this function internally and prints out to the external printer. This unique function can instantaneously prepare test performance sheets during installation and report the results of periodic maintenance without the need for manual or computer evaluation.

Features

- **Automatic measurement of A-A, A-D, D-A and D-D (A: analog, D: digital)**

This analyzer automatically measures most of the items stipulated in ITU-T Rec. G.712/713/714. The test sequence and parameters are stored internally, and new test sequences or parameters can be entered by the operator. Also, measurement can be done manually or via GPIB.

- **Frame alignment/alarm test**

Frame alignment and alarm tests stipulated in ITU-T Rec. G.704/O.162 can be made.

- **Error measurement**

Error rate, error count, error second, and % error-free second can be measured by detecting the bit, frame, and code errors.

- **Timing jitter measurement**

Jitter modulation is available. Also jitter amplitude and jitter immunity can be measured.

- **Signalling measurement**

Manipulation/monitoring of the signalling bit and E&M signalling distortion can be measured.

- **GPIB controller**

A GPIB controller function has been incorporated. One to thirty channels can be tested automatically and continuously through the channel selector.

- **Built-in printer**

Results are printed out by the built-in printer. In automatic measurement, all results can be printed out or the printout can be limited to results failing the evaluation.

- **External printer**

Results from channels 1 to 30 can be edited according to measuring item and printed out. A report, such as a test performance sheet, can be prepared immediately after the completion of measurements.

Functions

• Automatic measurement mode

In the automatic measuring mode, voice encode and decode performance characteristics can be measured. Encode and decode performance characteristics in the voice frequency are recommended in ITU-T Rec. G712/713/714/792 Q.507. Many items are required for voice frequency evaluation, and many points must be measured for each item.

In attenuation/frequency distortion, some compensation of the measurement value is required for each measurement frequency because of the absolute level difference caused in the reference frequency. Manual correction requires much time and effort to obtain the correct result.

The MS371A/A1 stores the reference frequency, the level difference in the frequency, the subsequent frequency for measurement, and the procedure for compensation operations at each frequency. As a result, the corrected result is reached automatically. Then the measured result is compared to a reference value in the memory to evaluate whether or not it passes or fails; evaluation is automatic. If it fails, the item, condition, and results can be printed out (fail-only printout or complete printout of results can be selected). In automatic measurement, the MS371A/A1 can measure the 15 items shown in the table below, including attenuation/frequency distortion. The measurement table summary indicates whether items can be measured or not by comparing the measurement configuration with measurement items. Functions that cannot be executed cannot be measured in principle.

Summary of automatic measurement

Measurement item	Measurement configuration				
	A-A	A-D	D-A	D-D	A-D/D-A*2
Level setting	√	√	√	√	√
Attenuation frequency distortion	√	√	√	√	√
Variation of gain with input level (tone)	√	√	√	√	√
Variation of gain with input level (noise)	√	√	√	√	√
Total distortion including quantizing distortion (tone)	√	√	√	√	√
Total distortion including quantizing distortion (noise)	√	√	√	√	√
Idle channel noise	√	√	√	√	√
Far-end crosstalk		√*1	√*1		√*1
Near-end crosstalk	√*1			√	
Go-to-return crosstalk	√			√	
Return loss	√*1	√*1	√*1		√*1
Spurious out-of-band signal	√		√		√
Discrimination against out-of-band input signal	√	√			√
Longitudinal balance	√	√	√		√
E&M signalling distortion	√	√	√	√	√

*1: Only when used with channel selector

*2: Measures D/A immediately after measuring A/D

As an application example, the measurement of PCM terminal voice encode and decode performance characteristics is shown below. This measuring method is used when installing PCM terminal equipment. Measurement items shown in the table of measurement summary are executed in the measuring sequence programmed into the MS371A/A1. (The operator can set individual items to be executed or omitted.) After measurement in channel 1, the MS371A/A1 controls the MS120A Channel Selector via the GPIB, connects the measuring terminal of

the MS371A/A1 to channel 2 of the PCM terminal equipment, and re-measures.

Measurement of one system portion of the terminal equipment is finished from channel 1 to 30 automatically in the same way. Upon completion of measurement, the measured results of channel 1 to 30 are edited according to each measurement item and output to the external printer. As mentioned above, voice channel measurement is fully automated, with no chance for miss operation.

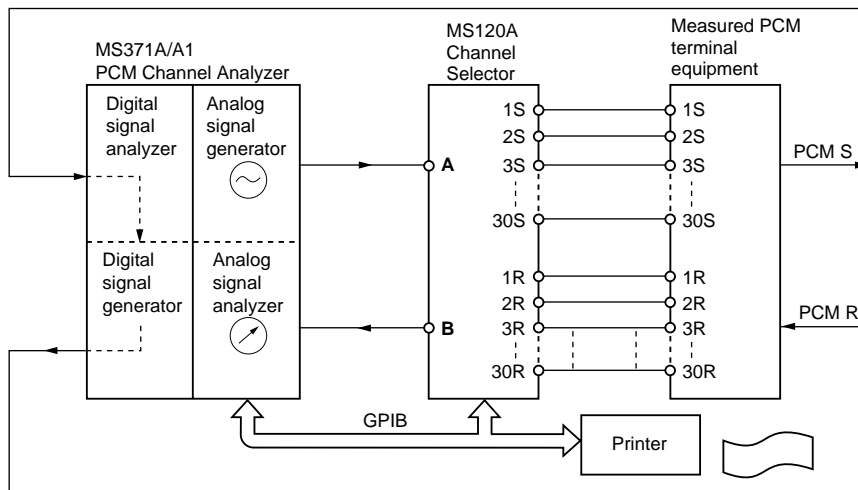

The MS371A/A1 controls the MS120A Channel Selector via GPIB. Port A scans from 1R to 30R and port B scans from 1S to 30S. This permits automatic testing of 30 PCM channels (1 system).

Four-wire VF interface PCM terminal equipment automatic testing

• Manual measurement mode

Table 1 summarizes the manual measurements. Manual measurements can be classified broadly as follows: voice channel, word test, alarm simulation, error measurement, signalling measurement, jitter measurement, and order wire.

Voice channel measurement

Manual measurement is used when varying the parameters more finely than in automatic measurement or when no measurement can be made in automatic measuring sequences, as in end-to-end measurement. Manual measurement is also suited to observing changes in results over time.

Word test

Voice channel, frame, non-frame, and multiframe words can be manipulated or monitored. Thus, spare bits included in the multiframe and non-frame can be functionally tested and defined and by the circuit user. The drop insert function of the voice channel can also be tested.

Alarm simulation

Frame, multiframe, or signal loss pseudo-errors can be inserted into the signal by the MS371A/A1 to test the alarm response of the equipment.

Error measurement

Per-channel (64 kbit/s) bit errors can be measured. Bit, line code, and frame word errors at 2 Mbit/s can also be measured. The error rate, error second, and % error-free second of these errors can then be automatically calculated.

Jitter measurement

In the digital signal generator, jitter can be generated at 2 Mbit/s interface and the digital signal analyzer can measure the jitter in a received signal. Combined use of jitter generation and error measuring functions enables measurement of jitter immunity.

Order wire

The front panel of the MS371A/A1 has a phone jack. Connection of a handset permits use of the circuit to be measured as an order wire.

Table 1 Manual measurement summary

Measurement item		Measurement configuration			
		A-A	A-D	D-A	D-D
Level measurement	Tone (FLM)	√	√	√	√
	Tone (SLM)	√	√	√	√
	Noise	√	√	√	√
Gain measurement	Tone (FLM)	√	√	√	√
	Tone (SLM)	√	√	√	√
	Digital mW (FLM)			√	√
	Digital mW (SLM)			√	√
	Noise	√	√	√	√
Total distortion including quantizing distortion	Tone	√	√	√	√
	Noise	√	√	√	√
Idle channel noise		√		√	√
Return loss		√			
Spurious out-of-band signal		√		√	
Coder offset	Tone		√		√
	Noise		√		√
Peak code detection	Tone		√		√
	Noise		√		√
Longitudinal balance		√	√	√	
Word test	Voice channel				√
	Frame				√*1
	Non frame				√*1
	Multiframe				√*2
Alarm simulation	AIS				√*1
	Signal loss				√*1
	Frame error				√*1
	Multiframe error				√*1
	Remote end frame error				√*1
	Remote end multiframe alarm				√*2
Error measurement	Error rate				√
	Number of errors				√
	Error seconds				√
	% error free seconds				√
Signalling measurement	E&M signalling distortion	√	√*3	√*4	√*2
	Bit test				√*2
Jitter measurement	Jitter immunity				√*5
	Jitter				√*6
Order-wire circuit		√	√	√	√

*1: When both digital interfaces of the transmitter/receiver are 2 M balanced or unbalanced

*2: When both digital interfaces of the transmitter/receiver are 2 M balanced or unbalanced 30 channels, CAS

*3: When the digital interfaces of the receiver is 2 M balanced or unbalanced 30 channels, CAS

*4: When the digital interfaces of the transmitter is 2 M balanced or unbalanced 30 channels, CAS

*5: When the digital interface of the transmitter is 2 M balanced or unbalanced

*6: When the digital interface of the receiver is 2 M balanced or unbalanced

Specifications

Analog signal generator	Sine wave signal output	Frequency range: 200 Hz to 10 kHz Frequency resolution: 10 Hz Frequency accuracy: $\pm 0.1\% \pm 0.1$ Hz Spurious including harmonics: >70 dB down (400 to 3500 Hz, +5 dBm), >60 dB down (200 to 400 Hz, +5 dBm), >50 dB down (3500 to 10000 Hz, +5 dBm) Level range: -80 to 13.1 dBm Level resolution: 0.1 dB
	Noise signal output Conforms to ITU-T Rec. O.131	Spectral span: 3.9 Hz Bandwidth: 200 Hz (350 to 550 Hz) Repetition rate: 256 ms Level range: -85 to 0 dBm Level resolution: 0.1 dB
	Output interface	Connector: 3-pole CF Impedance: 600, 900 Ω balanced Relative level: -20 to 10 dBr, 0.1 dB steps Max. DC isolation: ± 60 V DC loop: ICT, OGT selectable Current direction: Normal, reverse selectable (ICT only)
Activating signal generator		Spectral span: 7.81 Hz Bandwidth: 200 Hz Output level: -55 dB0 nominal Output interface: Same as analog signal generator
Analog receiver	Filters	In-band pre-filter: 200 to 6000 Hz Out-of-band pre-filter: 4.2 to 72 kHz Psophometric filter: Conforms to ITU-T Rec. O.41 3 kHz flat filter: 300 to 3400 Hz Band pass filters: 200, 300, 420, 500, 600, 820, 1020, 2400 2800, 3000, 3400, 3600 Hz selectable Notch filters: 820, 1020 Hz selectable Filter for S/N meter: Conforms to ITU-T Rec. O.131
	Input interface	Connector: 3-pole CF Impedance: 600, 900 Ω , high (> 20 k Ω), balanced, unbalanced selectable Relative level: -20 to +10 dBr, 0.1 dB steps Max, DC isolation: ± 60 V DC loop: ICT, OGT selectable Current direction: Normal, reverse, selectable (ICT only)
Digital signal generator	Sine wave signal output	Frequency range: 200 to 3990 Hz Frequency resolution: 10 Hz Frequency accuracy: $\pm 0.1\%$, ± 0.1 Hz Level range: -60 to 3.1 dBm0 Level resolution: 0.1 dB
	Noise signal output Conform to ITU-T Rec. O.131	Spectral span: 3.9 Hz Bandwidth: 200 Hz (350 to 550 Hz) Repetition rate: 256 ms Level range: -65 to 0 dBm0 Level resolution: 0.1 dB
	Digital mW signal	Conforms to ITU-T Rec. G.711
	Alarm simulation signal	PCM alarm signals: AIS, signal loss selectable Frame error signals: 1 in 2, 2 in 4, 3 in 4, 1.5×10^{-3} , 1.5×10^{-4} , 1.5×10^{-5} , 1.5×10^{-6} selectable Multifram error signal: 1 in 2, 2 in 2 Remote end frame alarm: Alarm bit "0" or "1" settable Remote end multifram alarm: Alarm bit "0" or "1" settable
	Word pattern manipulation	Telephone channel time slot: 00000000 to 11111111 settable Frame word: 00000000 to 11111111 settable Non-frame word: 00000000 to 11111111 settable Multifram word: 00000000 to 11111111 settable
	Error measurement signal	Pseudo-random binary sequence for 64 kbit/s: $2^{11}-1$ (ITU-T Rec. O.152) Pseudo-random binary sequence for 2.048 Mbit/s: $2^{15}-1$ (ITU-T Rec. O.151)
	Signalling bit test signal	Possible to set logic "0" or "1" to selected signalling channel in any bit: a, b, c
	Signalling distortion measurement signal (possible to inject measurement signal to selected signalling channel in any bit: a, b, c, d)	Pulse speed: 10, 20 pps selectable Marker ratio: 10 to 90%, 1 % steps
	PCM output interface Conforms to ITU-T Rec. G.703, G.704 (2.048 MHz, however, CRC code is not inserted)	Output impedance: 120 Ω balanced, 75 Ω unbalanced selectable Telephone channel number: 30, 31 channels selectable Signalling: Channel associated signalling, common channel signalling selectable Coding: HDB3, AMI selectable Synchronization: Internal, external 8 kHz frame signal (TTL), external 2.048 MHz clock signal (TTL) or from digital signal receiver selectable Connector: 3-pole CF (120 Ω bal.), BNC (75 Ω unbal.)
TTL output interface	Telephone channel number: 32 channels at 2.038 Mbit/s, signal channel at 64 kHz Synchronization: Internal, external 8 kHz frame signal (TTL), external 64 kHz (64 kbit/s interface), external 2.048 MHz (2.048 Mbit/s interface) or frame signal from digital signal receiver Connector: D-sub 25 pole (rear panel)	

Continued on next page

Digital receiver	Filters	<p>Psophometric filter: Conforms to ITU-T Rec. O.41 3 kHz flat filter: 300 Hz to 3.4 kHz Band pass filter: 200, 300, 420, 500, 600, 820, 1020, 2400, 2800, 3000, 3400, 3600 Hz selectable Notch filter: 820, 1020 Hz selectable Filter for S/N meter: Conforms to ITU-T Rec. O.131</p>
	Alarm display	Signal loss, AIS, frame loss, multiframe loss is indicated with the red LED display.
	Coder offset detection	Measurement range: -128 to +128
	Peak code detection	Measurement range: -128 to +128
	Remote end alarm detection	Remote end frame alarm, remote end multiframe alarm
	World pattern monitor	Telephone channel, frame word, non-frame word, multiframe word
	Error detection	<p>Detectable error: Code, frame, word, bit Measurement item: Error ratio, errored second, % error-free second, error count Acceptable bit error measurement pattern (64 kbit/s): $2^{11}-1$ (ITU-T Rec. O.152) Acceptable bit error measurement pattern (2.048 Mbit/s): $2^{15}-1$ (ITU-T Rec. O.151) Time base: 1 to 9999 s</p>
	Signalling bit monitor	Possible to display on selected signalling channel in a, b, c, d bit
	Signalling distortion meter (possible to measure selected signalling channel in any bit: a, b, c, d)	<p>Acceptable pulse speed: 10, 20 pps Mark ratio range: 0 to 100%</p>
PCN input interface	<p>Input impedance: 120 Ω balanced, 75 Ω unbalanced selectable Number of telephone channels: 30, 31 channels selectable Signalling: Channel associated signalling, common channel signalling selectable Coding: HDB3, AMI selectable Synchronization: Regenerated frame and multiframe from incoming PCM signals Connector: 3-pole CF (120 Ω bal.), BNC (75 Ω, unbal.)</p>	
Conforms to ITU-T Rec. G.703, G.704 (2.048 MHz)		
TTL input interface	<p>Number of telephone channels: 32 channels at 2.048 Mbit/s, single channel at 64 bit/s Synchronization: External 8 kHz frame signal Connector: D-sub 25-pole (rear panel)</p>	
Jitter detection (PCM interface only)	<p>Frequency mode: Conforms to ITU-T Rec. O.171 Amplitude of modulated jitter:</p> <p>Range: 1 UI, 10 UI selectable Amplitude and frequencies: Conforms to ITU-T Rec. O.171 Amplitude of measured jitter:</p>	
E&M test signal generator	Measurement parameters	<p>Pulse speed: 10, 20 pps selectable Mark ratio: 10 to 90%, 1% steps</p>
	Interface	<p>DC sink current: 100 mA maximum (make) Output impedance: >22 kΩ (brake) Switch voltage: 53 V maximum Connector: 3-pole CF (rear panel)</p>
E&M signalling receiver	Measuring range	<p>Pulse speed: 10 to 20 pps Mark ratio: 0 to 100%</p>
	Interface	<p>Input impedance: 3.3 kΩ internally pulldown to -48 V Connector: 3-pole CF (rear panel)</p>

Continued on next page

Others	Order wire	Voice signal output: Analog signal generator or selected digital signal generator output port Voice signal input: Analog signal receiver or selected digital signal receiver input port Headset connector: 4-pole modular telephone jack
	Loudspeaker (for audible alarm and received voice monitor)	Monitor: Selected telephone channel in digital signal or analog input signal Monitor level: Adjustable with knob on front panel
	Display	128 x 256 dots LCD with back light
	Built-in printer	Printing method: Thermal Printing letter: 20 characters/line
	Real time clock	YY, MM, HH, mm, ss (Y: year, M: month, D: date, H: hour, m: minute, s: second)
	GPIB (conforms to IEEE Std. 488-1978)	Implementation: SH1, AH1, T6, TE0, L4, LE0, SR1, RL1, PP0, DC1, DT1, C1, C2, C3, C27
General	Power	AC: 100 V $\pm 10\%$, 50/60 Hz, approx. 130 VA
	Dimensions and mass	425 (W) x 177 (H) x 451 (D) mm, ≤ 25 kg
	EMC	EN61326: 1997/A1, 1998 (Class A) EN61000-3-2: 1995/A2, 1998 (Class A) EN61326: 1997/A1, 1998 (Annex A)
	LVD	EN610101-1: 1993/A2, 1995 (Installation Category II, Pollution degree 2)

The MS371A1 is the same as the MS371A but also has 64 kb/s co-contradirectional interface.

Ordering information

Please specify model/order number, name, and quantity when ordering.

Model/Order No.	Name
MS371A	Main frame PCM Channel Analyzer
MS371A1	PCM Channel Analyzer
J0162B	Standard accessories Balanced cable (both ends with Siemens 3P-type plug): 4 pcs
J0081	BNC cable (both ends with BNC-type plug): 2 pcs
J0586	TTL interface connector: 1 pc
	AC power cord, 2.5 m: 1 pc
	DC power plug: 1 pc
J0443	Fuse, 2 A: 1 pc
F0011	Fuse, 3.15 A: 2 pcs
F0012	Fuse, 0.315 A: 1 pc
F0040	Fuse, 1 A: 3 pcs
F0043	Fuse, 1.6 A: 1 pc
F0044	Fuse, 3.15 A: 2 pcs
F0046	Thermal paper for printer: 2 rolls/set
Z0031A	MS371A/A1 operation manual: 1 copy
W0161AE	
MS120A*1	Optional accessories Channel Selector
J0162A	Balanced cable, 1 m
J0081	BNC cable (both ends with BNC-type plug, 3C-2V), 2 m
A0006	Headset
MB23A	Portable Test Rack
MB24A	Portable Test Rack
J0007	GPIB cable, 1 m
J0008	GPIB cable, 2 m
B0169A	Transport quilting
B0239A	Protective carrying case (for MS371A)
B0239B	Protective carrying case (for MS371A1)
B0043	Rack mount kit 4U (2 pcs/set)
B0020	Protective cover (2 pcs are needed.)

*1: Do not meet the EMC and low voltage directives of European Union.

DIGITAL TRANSMISSION ANALYZER ME3401A

For Measuring Error of DS-3, DS-2, DS-1C and DS-1 Systems



GPIB
OPTION

The ME3401A offers portability and easy operation and is ideal for testing, evaluating, and monitoring DS-2, DS-1C, and DS-1 system as well as the DS-3 system. This multifunctional instrument has five error detection functions (bit, parity, frame, bipolar violation, and CRC-6), seven measurement functions (error rate, error count, error seconds, % error free seconds, threshold error seconds, error performance data, and alarm seconds), jitter modulation and measurement functions, and multiplexer test functions. These functions make the ME3401A a powerful tool for commissioning, and production tests, as well as for maintaining, and troubleshooting digital radios, fiber optic systems, and digital multiplexers. In addition, live traffic performance can be measured by using a wide input range, the frame error detection function, the demultiplex function, and the built-in printer. The printer outputs the measurement results and automatically records the time, and contents when an error or alarm occurs. The receiver makes it easy to measure the error rate or error count distribution and error performance*. *: ITU-T G.821

Features

- Suitable for all systems: DS-3, DS-2, DS-1C, and DS-1
- Jitter modulation and measurement (option)
- Demultiplex function
- Various error detection and measurement functions
- Through data function

STM/SONET ANALYZER MP1560A

Supports Japanese, ITU-T and SONET Specifications



Custom-made product

GPIB

The MP1560A STM/SONET Analyzer is an error analyzer for the Network Node Interface (NNI) of the Synchronous Digital Hierarchy (SDH). The MP1560A provides many useful functions for evaluating equipment during design, manufacturing, and development and is especially suited for evaluating the transmission characteristics of the 52, 100, and 156 Mb/s interfaces used in SDH equipment.

The transmitter and receiver are housed in one frame and optical interfaces (plug-in unit) are provided. In addition to functions for setting and storing 64 frames of data in memory (option 01), a PTA controller function (option 03/04) and 28-channel (maximum) simultaneous measurement function (option 02) can be built-in.

Features

- Meets mappings for ITU-T (Europe), SONET (North America), and Japan
- Can be used to analyze a variety of signal sources: optical (1.31/1.55 μm), unipolar, CMI, B3ZS (52 Mb/s), AMI (100 Mb/s)
- Many measurement items and functions for inserting alarms and errors
- OH byte can be set and monitored
- ADD and DROP for 1.5 Mb/s, 2 Mb/s, 64 kb/s, 192 kb/s, 576 kb/s
- Built-in floppy disk drive

PCM CODEC ANALYZER MS369B

For Measuring CODECs



GPIB

The MS369B uses new technology to measure the characteristics of PCM CODECs (Coder, Decoder). Single-channel CODECs (SCC) are already being produced by many semiconductor makers for PCM terminal equipment, digital exchanges, PBX, digital telephones, and so on. The number of SCCs in use is increasing gradually. In addition, former common-channel CODECs used time sharing among a number of channels. Measuring the characteristics of one single channel make it possible to dispense with measurement of the other common channels. For equipment using SCCs, however, the encoding and decoding characteristics for each channel must be measured. As a result, more channels must be measured which will lead to demands for improved measuring performance.

The MS369B uses DSP (Digital Signal Processing) technology to reduce measuring time and to improve measuring accuracy. It also incorporates a high-performance, special-purpose LSI developed by Anritsu. The MS369B reduces measuring time and automates measurement using GPIB, and increases production and maintenance efficiency.

Features

- Both A-law and μ -law measurement
- A-A, D-A, A-D, and D-D measurement

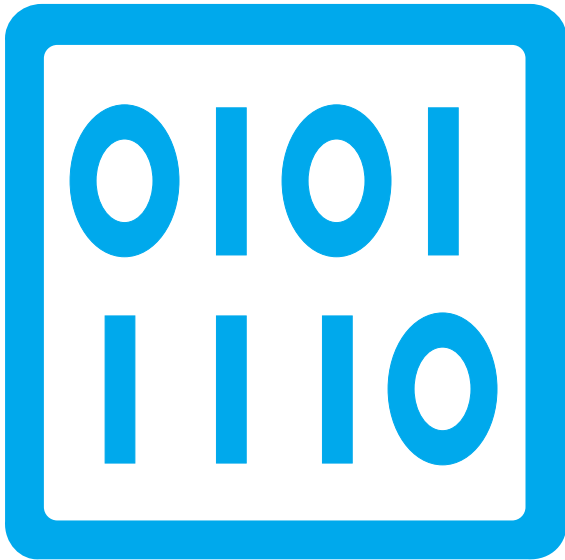

DATA COMMUNICATIONS MEASURING INSTRUMENTS

Network Data Analyzer	196
Data Transmission Analyzer	200

NETWORK DATA ANALYZER
MD6430A
 50 bit/s to 10 Mbit/s

One Instrument for Installation and Maintenance



The MD6430A Network Data Analyzer can measure errors on 13 different interfaces for leased lines (64 kbit/s to 6.3 Mbit/s), ISDN (BRI, PRI), and V/X series interfaces, making it suitable for installation and maintenance of a variety of networks. Measurements include bit errors, alarms, delay time, frequency, digital level measurements, user pattern send/trace, etc., all of which can be displayed on the large color LCD. Error performance (ITU-T G.821, G.826, M.2100) is available with various pseudorandom patterns and user patterns up to 1024 characters. Frame Relay measurement function, ISDN signaling function (optional), and a simultaneous two-channel monitoring function are also provided. Single button "quick" function and touch-screen ensure easy operation. This unit offers the user sophisticated functions required for installation and maintenance in a small compact unit.

Features

- One unit supports installation and maintenance of leased lines, ISDN, and frame relay
- Single button quick test operation
- Lightweight, with a battery-operated function

Applications

- Many applications ranging from low-speed modems to high-speed digital lines

The MD6430A can evaluate the quality of lines ranging from low-speed modems to high-speed digital lines spanning 50 bit/s to 10 Mbit/s.

Support for various interfaces

The MD6430A supports G.703 64k, I.430/I.430a 192k, G.703/G.704/I.431 1.5M, 2M, 2M CMI, 6.3M, V.24/V.28, V.35, V.36, RS-449, X.20, X.21, TTL/CMOS interfaces in a number of optional units designed to meet customer needs.

Units	Interfaces	Uses
MU643000A	G.703 64k, I.430/I430-a 192k, G.703/G.704/I.431 1.5M, G.703/G.704/I.431 2.0M, 2M CMI, G.703/G.704 6M	Europe and Japan
MU643000B	G.703 64k, I.430/I430-a 192k, G.703/G.704/I.431 1.5M, 2M CMI, G.703/G.704 6M	Japan
MU643000C	G.703 64k, I.430/I430-a 192k, G.703/G.704/I.431 2.0M	Europe

Note: All interface units support V.24/V.28, V.35, V.36, RS-449, X.20, X.21, and TTL/CMOS.

Wide variety of measurement functions

Various measurements, such as error, alarm, clock slip, delay, frequency, and digital level can be performed. Also, can send user patterns with tracing functions.

Frame relay measurements

Frame relay network connections (conforming to PVC and ITU-T Q.933 Annex A) can be tested by the MD6430A. The user can also monitor the congestion status such as FECN, BECN, and CLLM.

Optional ISDN signaling functions (BRI, PRI)

The unit can be connected to ISDN networks so that both voice communication and error measurement can be performed.

Error data analysis and storage functions

Error data can be collected in log or histogram format. This data can also be stored in internal memory or on a floppy disk for later analysis.

Touch-screen

The touch-screen, large color LCD, and pop-up menus provide a much better GUI operating environment.

Battery operation

When a commercial power supply is not available, the optional battery pack provides operation for up to 3 hours, and 5 hours in power save operation.

Full range of error measurement screens

Various measurement items can be displayed simultaneously for error count, error rate, block error count, clock slip count, character error count, error performance (G.821, G.826, M.2100), HDLC error (bad frame, abort frame), and various types of alarm. The user can select the desired items and can display them using the zoom function.



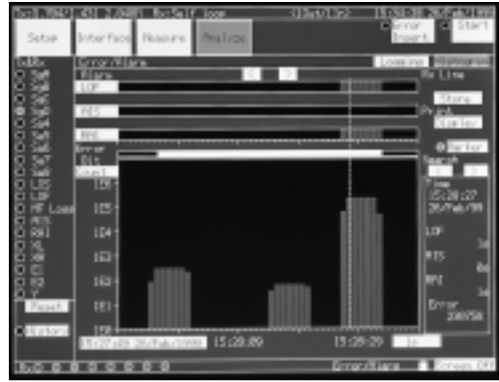

• **Supports frame relay measurements**

Specific DLCI connections can be checked. PVC status checking procedures are supported.

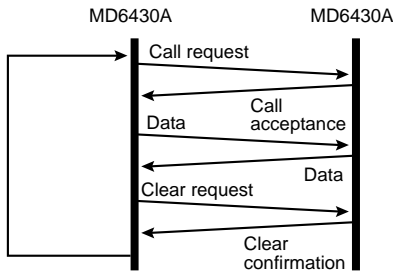

Frame relay measurement sequence



• **Substantial analysis functions**

Error status and alarm condition can be logged and displayed as histograms. The received data can also be captured.



• **Supports ISDN networks (BRI, PRI)**

The unit can be connected to the ISDN public telephone network. Return testing using one unit can be done by using the call loop function as below.



• **Voice channel function**

The CODEC function permits voice communications over a specified channel. Simultaneous voice communications and measurements are possible.



• **Easy operation**

The touch-screen and pop-up menus are quick and user-friendly, making operation easy for all levels of expertise.

Specifications

Interface	High speed: G.703 64k, I.430/I430-a 192k, G.703/G.704/I.431 1.5M ^{*1,*2} , G.703/G.704/I.431 2.0M ^{*1,*3} , 2M CMI ^{*1,*2} , G.703/G.704 6M ^{*1,*2} (2-wire simultaneous monitoring) Low speed: V.24/V.28, V.35, V.36, RS-449, X.20, X.21, TTL/CMOS (Send/receive simultaneous monitoring)
Clock (high-speed interface)	Internal clock: 64 kbit/s, 1.544 Mbit/s ^{*1,*2} , 2.048 Mbit/s, 6.312 Mbit/s ^{*1,*2} (accuracy $\leq \pm 5$ ppm) External clock: 64k + 8k or slave sync to received data (slave oscillation range: $\leq \pm 100$ ppm)
G.703 64k clock mode	Centralized clock, codirectional clock
Code law (high-speed interface)	G.703 64k: AMI I.430/I430-a 192k: AMI G.703/G.704/I.431 1.5M: AMI/B8ZS ^{*1,*2} G.703/G.704/I.431 2.0M: AMI/HDB3 ^{*1,*3} 2M CMI: CMI G.703/G.704 6M: B8ZS ^{*1,*2}
Impedance	64k: 110 Ω /HIGH, 192k: 50/100 Ω /HIGH, 1.5M: 100 Ω /HIGH, 2 M: 75/120 Ω /HIGH, 2M CMI: 110 Ω /HIGH, 6M: 75 Ω /HIGH
Frames (high-speed interface)	G.703/G.704/I.431 1.5M ^{*1,*2} : 12MFP (G.704), 24MFP (G.704), 24MFP (NTT), unframe G.703/G.704/I.431 2.0M ^{*1,*3} : 16MFP (30B + D), 16MFP (31B), 2MFP (30B + D), 2MFP (31B), Unframe 2M CMI ^{*1,*2} : PBX (TTC), CRV, ST (send only), unframe G.703/G.704 6M ^{*1,*2} : 4MFP (G.704), unframe
Data bit rate (high-speed interface)	64k x n: 64 to 6272 kbit/s (n = 1 to 98 ^{*4} , sequential or mixed configuration may be selected.) 56k (1-7) x n: 56 to 5488 kbit/s (n = 1 to 98 ^{*4}) 56k (2-8) x n: 56 to 5488 kbit/s (n = 1 to 98 ^{*4}) 8k x n: 8, 16, 32 kbit/s 2.4k x n: 2.4 to 48 kbit/s (n = 1 to 20, sequential or mixed configuration may be selected for X.50 20 multiframe.) 0.6k x n: 0.6 to 48 kbit/s (n = 1 to 80, sequential or mixed configuration may be selected for X.50 80 multiframe.) Others: Signaling, 1.544 Mbit/s
Send clock (low-speed interface)	Internal clock Sync (ST1): 50 bit/s to 10 Mbit/s (5 bit/s steps. However, V.24/V.28 and X.20 up to 200 kbit/s) Async: 50, 75, 100, 110, 150, 200, 256, 300, 400, 500, 512, 600, 768, 800, 1k, 1.2k, 1.6k, 1.8k, 2k, 2.4k, 2.56k, 3k, 3.2k, 3.6k, 4.8k, 7.2k, 8k, 9.6k, 12k, 12.8k, 14.4k, 16k, 16.8k, 19.2k, 28.8k, 32k, 38.4k, 46k, 48k, 50k, 56k, 56.6k, 64k, 72k, 76.8k, 115.2k (bit/s) Self oscillation accuracy: $\leq \pm 5$ ppm External clock (ST2, RTS): Frequency for each interface of 50 to 10 Mbit/s (may be inverted.)
Receive clock (low-speed interface)	External clock (ST, RTS): Frequency for each interface of 50 to 10 Mbit/s (May be inverted) Internal clock (Async): 50, 75, 100, 110, 150, 200, 256, 300, 400, 500, 512, 600, 768, 800, 1k, 1.2k, 1.6k, 1.8k, 2k, 2.4k, 2.56k, 3k, 3.2k, 3.6k, 4.8k, 7.2k, 8k, 9.6k, 12k, 12.8k, 14.4k, 16k, 16.8k, 19.2k, 28.8k, 32k, 38.4k, 46k, 48k, 50k, 56k, 56.6k, 64k, 72k, 76.8k, 115.2k (bit/s)
Error measurement pattern	Pseudorandom pattern: PRBS 6, 7, 9, 11, 15, 19, 20, 23, RPRBS 20 (reversed PRBS20), QRSS, positive/negative logic Programmable pattern: 8 bit repetitive (start-stop sync: 5 to 8 bits) Code pattern: 1:1, ALL 1, ALL 0 User pattern: 1 to 1024 characters (1 character steps), for character error measurement
Send pattern	User pattern: 1 to 128 kbyte
Error insertion	Error type: bit, bit + code, code Insertion types Single: 1 bit error inserted each time insert button pressed Repeat: 1 bit error inserted each second Cyclic: 2.5E-1 to 1.7E-7
Start-stop synchronization	Start bit length: 1 bit Stop bit length: 1, 1.5, 2 bits Data length: 5, 6, 7, 8 bits Parity: None, odd, even
Error/alarm measurement	Detected errors: Bit, code, parity, CRC, frame, character Measurements: Error count, error rate, block error count, block error rate, ES, EFS, clock slip, clock slip seconds, pattern sync loss count/time, frame sync loss time, alarm time, signal loss time, AC power loss time Error performance: G.821, G.826, M.2100 Measurement modes Single: 1 s to 99 d 23 h 59 min 59 s Repeat: 1 s to 99 d 23 h 59 min 59 s Manual: 1 y max. Measurement range Error rate: 1.00E-15 to 1.00E00, Error count: 0 to 9.99E15
Pattern trace	Trace byte count: 1 Mbit max. Trace start trigger: Manual, code detect Trace stop trigger: Manual, code detect, code mismatch detect, trace byte count Trigger detect delay: 0 to 8,000 bytes
Frequency measurement	Measurement range: DC to 10 MHz, Accuracy: $\leq (\pm 5 \text{ ppm} \pm 1 \text{ digit})$
Delay time measurement (Sync. mode only)	Measurement range: 0 to 16 s (0.001 ms steps)
Frame relay measurement	Measurement items: Correct test packet count, lost test packet count, HDLC bad frame count, HDLC abort frame count PVC connect confirmation test: To MD6430A or circuit loopback test (Conforms to ITU-T Q.933 Annex A) DLCI: 16 to 991 (1 steps) Test packet send interval time: 5 to 30 s (1 s steps) Traffic congestion status monitoring: BECN, FECN, CLLM message detection (Conforms to ITU-T Q.922 Annex A)
Digital level measurement	Code law: A-law, μ -law Measurement range: -60 to +3 dBm (0.1 dBm steps) Send pattern: 0 dBm, 1 kHz pattern (Conforms to ITU-T G.711)

Continued on next page

ISDN calling/called function	INS64, INS1500 (Option: MU643000A/B-01), ETS1 ISDN (Option: MU643000A/C-02)
MUX/DEMUX	Able to drop/insert specified channels in high-speed interface through X.21 interface at 64k x n (n = 1 to 98)
Voice communication	Voice communication possible in any TS in high-speed interfaces (except G.703 64 kbit/s)
Error analysis	Displays sequential error/alarm measurement data and graphs
Signal monitor lamp	Indicates status of each signal line
External printer	Interface Centronics, D-sub 25-pin connector
External printer output	Enables printout of error measurement data Measurement start time: Prints time and measurement conditions During measurement: Prints specified error and alarm occurrence at each detected instance or at predefined time interval Measurement stop time: Prints measured total results Prints on screen contents
Display	Color TFT-LCD (8.4 inch)
Remote interface	RS-232C, D-sub 9-pin connector, GPIB (option)
Memory	3.5 inch FDD
Built-in timer	Year, month, day, hour, minute, second
Power supply	AC: 85 to 250 V, DC: Lithium ion battery (rechargeable, optional accessory), 50 VA
Battery operation time	3 h (max.) *5 h when using power save function
Operating temperature	0° to 50°C, (FDD and at battery usage: +5° to +40°C)
Dimensions and mass	290 (W) x 194 (H) x 94 (D) mm, ≤4.2 kg (excluding battery)
EMC	EN61326: 1997/A1: 1998 (Class A), EN61000-3-2: 1995/A2: 1998 (Class A), EN61326: 1997/A1: 1998 (Annex A)
LVD	EN610101-1: 1993/A2, 1995 (Installation Category II, Pollution degree 2)

*1: Specification when using MU643000A Datacom Interface

*2: Specification when using MU643000B Datacom Interface

*3: Specification when using MU643000C Datacom Interface

*4: Max. n value depends on interfaces

Ordering information

Please specify model/order number, name, and quantity when ordering.

Model/Order No.	Name
MD6430A	Main frame Network Data Analyzer
ADP60WB24.0	Standard accessories AC adapter (100 to 240 Vac/24 Vdc converter): 1 pc Power cord: 1 pc
Z0406A	Touch pen (for touch panel): 1 pc
Z0402A	Protective cover (protects display): 1 pc
W1542AE	MD6430A operation manual (includes MU643000A/B/C): 1 copy
W1543AE	MD6430A remote control operation manual (includes MU643000A/B/C): 1 copy
Z0417	MD6430A sample program (remote sample program): 1 pc
Z0403A	Belt with hook (MD6430A carrying belt): 1 pc
MD6430A-01	Options GPIB
J1026A	GPIB cable (for MD6430A-01's accessory), 2 m
MU643000A	Units Datacom Interface Unit (for Europe and Japan)
MU643000B	Datacom Interface Unit (for Japan)
MU643000C	Datacom Interface Unit (for Europe)
MU643000A-01	Options JT-Q921/Q931 ISDN signaling
MU643000A-02	ETSI ISDN signaling
MU643000B-01	JT-Q921/Q931 ISDN signaling
MU643000C-02	ETSI ISDN signaling
MU643000A-22	CAS/FAS option (for Europe and Japan)
MU643000B-22	CAS/FAS option (for Japan)
MU643000C-22	CAS/FAS option (for Europe)
Z0404A	Optional accessories Lithium ion battery pack (battery pack for main frame)
B0441	Hard carrying case
B0442	Soft carrying case
B0443	Rack mount kit
A0006	Headset
J0654A	Serial interface cross cable [D-Sub 9-pin (female) · D-Sub 9-pin (male)], 2 m (for remote control of main frame)
J0661A	RS-232C straight cable [D-Sub 9-pin (female) · D-Sub 25-pin (male)], 2 m (for remote control of main frame)
J0920B	Cross cable [D-Sub 9-pin (female) · D-Sub 25-pin (male)], 3 m (for remote control of main frame)
J0913A	Measurement cable [D-Sub 25-pin (male) · half pitch 36-pin], 2 m (for V.24/V.28)
J0914A	Measurement cable [V.35 connector (male) · half pitch 36-pin], 2 m (for V.35)

Model/Order No.	Name
J0915A	Measurement cable [D-Sub 37-pin (male) · half pitch 36-pin], 2 m (for V.36/RS-449)
J0916A	Measurement cable [D-Sub 15-pin (male) · half pitch 36-pin], 2 m (for X.20/X.21, using B terminal as ST1 output type)
J0945	Measurement cable [D-Sub 15-pin (male) · half pitch 36-pin], 2 m (for X.20/X.21, using B terminal as ST2 input type)
J0929	Cross measurement cable [D-Sub 15-pin (male) · half pitch 36-pin], 2 m (for X.20/X.21 MUX/DEMUX)
J0388B	DCE/DTE conversion adapter (D-Sub 25-pin, for V.24/V.28)
J0390	DCE/DTE conversion adapter (D-Sub 34-pin, for V.35)
J0392B	DCE/DTE conversion adapter (D-Sub 37-pin, for V.36/RS-449)
J0917A	TTL/CMOS connection box*1 (I/O connector: BNC type)
J0923	Measurement cable (both-end Amphenol half pitch 36-pin), 1 m (for connection between MD6430A to TTL/CMOS)
J0463C	Measurement cable [both-end 8-pin modular (RJ45) with shield], 2 m (for 192k)
J0959B	Measurement cable (RJ45 8-pin modular · clip), 2 m (for 192K)
J0844A	ISO1073 cable [both-end 8-pin modular (ISO10173)], 2 m (for 1.5M, 2M)
J0127B	Coaxial cord (BNC-P · RG58A/U · BNC-P), 2 m (for 2M, 6M)
J0939	Coaxial cord (C-H3T type plug · BNC), 2 m (for 6M)
J0921B	Measurement cable [8-pin modular (ISO10173) · M-1PS], 2 m (for 1.5M, 2M)
J0922B	Measurement cable (mini-BANTAM · M-1PS), 2 m (for 64k, 2M CMI)
J0924B	Measurement cable (mini-BANTAM · I-214APS), 2 m (for external input clock, 64k + 8k)
J0930	Measurement cable (mini-BANTAM · M-3912), 2 m (for 64k, Siemens type)
J0960B	Measurement cable (mini-BANTAM · clip), 2 m (for 64k, 2M, CMI)
J0946A	Measurement cable [8-pin modular (ISO10173) · M-3912], 1 m (for 1.5M/2M)
J0946B	Measurement cable [8-pin modular (ISO10173) · M-3912], 2 m (for 1.5M/2M)
J0950	Measurement cable [8-pin modular (ISO10173) · clip], 2 m (for 1.5M/2M)
J0968	Balance cable (RJ45 · ISO10173), 2 m (for 192k)
J0969C	Unbalance cable [SP3CP/3CV-P (BNC)], 2 m (for 6M)
J0925B	Y cable (D-sub 25-pin · half pitch 36-pin/D-sub 25-pin), 2 m (for V.24/V.28 monitor)
J0926B	Y cable (D-sub 25-pin · half pitch 36-pin/D-sub 25-pin), 2 m (for V.35 monitor)
J0927B	Y cable (V.37 · half pitch 36-pin/D-sub 37), 2 m (for V.36/RS-449 monitor)
J0928B	Y cable (D-sub 15-pin · half pitch 36-pin/D-sub 15-pin), 2 m (for X.20/X.21 monitor)

*1: Cable (J0923) required when using with TTL/CMOS interface

Note: For details of the measurement cable, refer to the Measurement Cable Selection Guide in the MD6430A Application Note.

DATA TRANSMISSION ANALYZER
MD6420A

For Evaluating Quality of Digital Data Networks

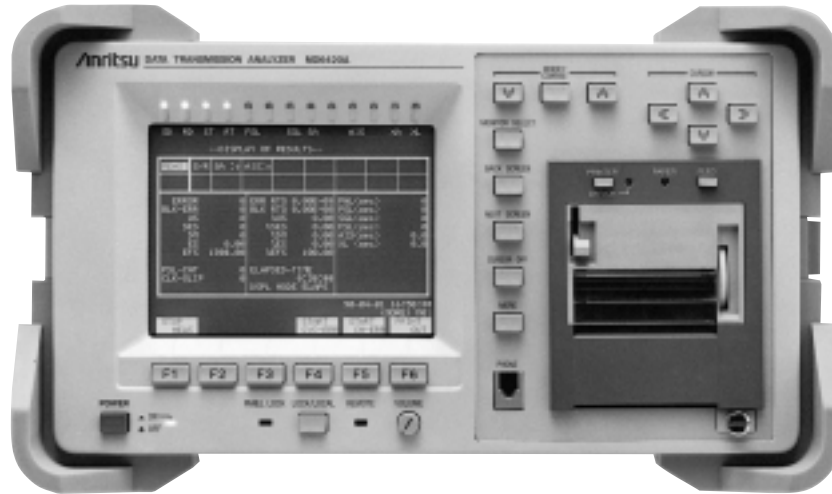

**GPIB
OPTION**

Bit error rate measurement is the most critical parameter in evaluating the quality of digital transmission modes. However, conventional methods, which measure only average bit error rates, are inadequate. In the MD6420A, various types of extension and remote control units are provided as options, as well as units which allow the use of various types of interfaces.

The measuring conditions can be stored in memory and recalled prior to measurement with the touch of a single key. An error analysis function allows histograms of either error or alarm data to be quickly and easily displayed. In addition, the analyzer is portable so that it can be used on site for maintenance operations.

Features

- Can measure a variety of devices from low-speed modems to high-speed digital lines

Can be configured to a variety of communications protocols via ITU-T V, X, G, and I series by using plug-in units. Can perform high-quality evaluations of data communications systems that have bit rates from 50 b/s to 10 Mb/s.

- Simultaneous error measurement of various error parameters

The error count (bit error, parity error, and CRC error, etc.) error rate, block error count, block error rate, US, %US, SES, %SES, DM, %DM, ES, %ES, EFS, %EFS, AT, %AT, BBER, clock slip, and synchronization loss can be measured, Alarm states such as AIS can be continuously monitored*.

*: Conforms to ITU-T G.821

- Data will not be lost if a power failure occurs during measurement

If an AC power failure occurs during error rate measurements, all data obtained prior to the failure is recalled from memory and the measurement is automatically continued when the power is resupplied. When the power returns, the time at which power failure occurred is displayed on the EL display.

- Storage and statistical analysis of error measurement data

When a error analysis unit is used, the error measurement data can be stored in the unit. The results of stored data analyses can be displayed as a histogram.

Example of display screen

- Overall display of error measurements

Up to 22 measurement items can be monitored simultaneously. If a power failure occurs during measurements then measurements will be continued from the time at which the power is resupplied. The failure time (PWL) will be displayed when power is resupplied.

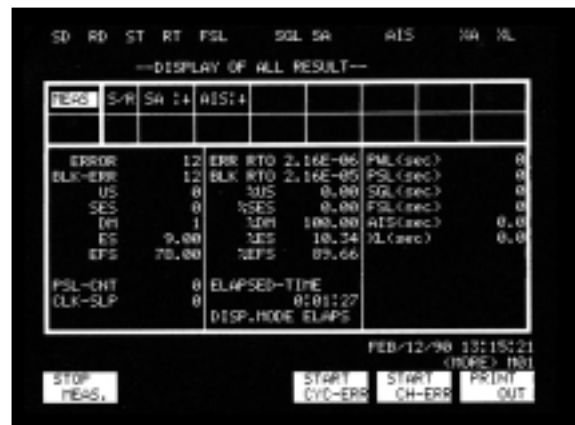

- Histogram screen

The number of errors and the rates of which errors occurred can be displayed relative to the time of measurement. The parameters which are to be displayed on the horizontal and vertical axes can be selected by the user.

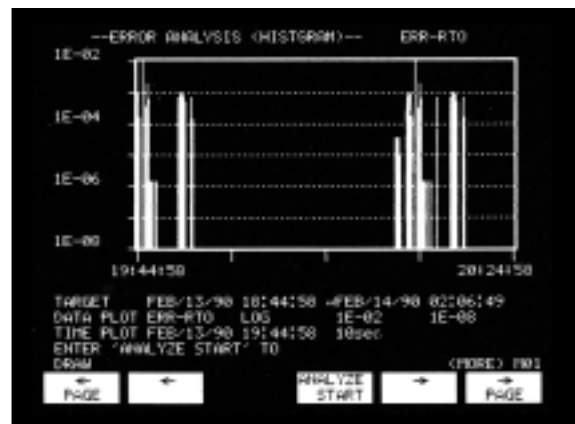

Combinations of interface and extension units

The MD6420A can be combined with many plug-in units to perform a variety of measurement.

	Extension units							
	MD0627A Analog	MD0630A Distortion Measurement	MD0630B CODEC	MD0632A 64 kb/s Jitter	MD0632B 1.544 Mb/s Jitter	MD0632C 2.048 Mb/s Jitter	MD0633A Error Analyzer	MD0610D/D1 Word Memory
Interface units								
MD0621A V.24/V.28 (RS232C)	√	√					√	√
MD0621B V.35	√	√					√	√
MD0621C V.36 (RS-449)	√	√					√	√
MD0621D X.20 (RS-423)/X.21 (RS-422)	√	√					√	√
MD0622B G.703/G.704 1.544 Mb/s Bipolar	√*		√		√		√	√
MD0622D G.703/G.704 6.312 Mb/s Bipolar	√*						√	√
MD0622E G.703 64 kb/s	√*		√	√			√	√
MD0623A/A1 G.703/G.704 2.048 Mb/s Bipolar	√*		√			√	√	√
MD0623B G.703/G.741 8.448 Mb/s Bipolar	√*						√	√
MD0625B I.431 1.544 Mb/s	√*		√		√		√	√
MD0625C/C1 I.431 2.048 Mb/s	√*		√			√	√	√
MD0626A TTL	√*	√					√	√
MD0628B DS1	√*		√		√		√	√
MD0628C DS1C	√*						√	√

*: Except DC voltage measurement

Interface units

• V/X series

MD0621A	V.24/V.28 (RS-232C)
MD0621B	V.35
MD0621C	V.36 (RS-449)
MD0621D	X.20 (RS-423)/X.21 (RS-422)

• G.703

MD0622B	G.703/G.704 1.544 Mb/s Bipolar
MD0622D	G.703/G.704 6.312 Mb/s Bipolar
MD0622E	G.703 64 kb/s
MD0623A/A1	G.703/G.704 2.048 Mb/s Bipolar
MD0623B	G.703/G.741 8.448 Mb/s Bipolar

• I.431

MD0625B	I.431 1.544Mb/s
MD0625C/C1	I.431 2.048Mb/s

• TTL

MD0626A	TTL
---------	-----

• For North America

MD0628B	DS1
MD0628C	DS1C

Extension units

• Analog

MD0627A	Analog
---------	--------

• Measurement extension

MD0630A	Distortion Measurement
MD0630B	CODEC
MD0610D/D1	Word Memory
MD0632A	64 kb/s Jitter
MD0632B	1.544 Mb/s Jitter
MD0632C	2.048 Mb/s Jitter

• Error analysis

MD0633A	Error Analyzer
---------	----------------

Remote control units

MD0620A	GPIO
MD0620B	RS-232C

Specifications

Sending clock signal	Internal clock signal (ST1, ASYNC, ST/SP)*1	Clock: 50 to 20 kb/s in 5 b/s steps, 20 k to 400kb/s in 100 b/s steps 512 k, 576 k, 672 k, 768 k, 1024 k, 1152 k, 1344 k, 1536 k, 1920 k, 2048 k, 4096 k, 8192 kb/s Accuracy Self oscillation: ± 5 ppm Slave oscillation: Subject to 8 kb/s or 8 kb/s of (64 k + 8 k) external input or receiving data Slave oscillation range: $\geq \pm 100$ ppm
	External input	Operated by the external input clock signal (TTL level or sine waves)
	External clock signal (ST2, RT)	Clock (inversion can be used.) by each 50 b/s to 10 Mb/s interface
Receiving clock signal	External clock signal (RT)	Clock (inversion can be used.) by each 50 b/s to 10 Mb/s interface
	Internal clock signal (ASYNC, ST/SP)	50, 70, 100, 150, 200, 256, 300, 400, 500, 512, 600, 768, 800, 1 k, 1.2 k, 1.6 k, 1.8 k, 2 k, 2.4 k, 2.56 k, 3 k, 3.6 k, 4.8 k, 7.2 k, 9.6 k, 14.4 k, 19.2 kb/s
Pattern	Code	A, Z, 1:1, 3:1, 1:3, 7:1, 1:7
	Programmable pattern	8 bit repetition (5 to 8 bits for ST/SP, 5 bits for 2.0 M G.704 spare bit)
	Pseudorandom pattern	$2^n - 1$ bits repetition (n: 6, 7, 9, 11, 15, 19, 20, 23), positive/negative logic
	Word pattern	8 bits x 8 k words (manual input, setting, user's pattern)
	FOX pattern	Conforms to ITU-T (EBCDIC, ASCII, EBCD, BAUDOT)
Error insertion	Manual error	Single-bit error whenever the key is pressed or single-bit error every second
	Cyclic error	2.5×10^{-1} to 1.7×10^{-7} (N x 10^{-n} , N: 1.0, 1.1, 1.3, 1.5, 1.7, 2.0, 2.5, 3.0, 4.0, 5.0, 6.0, 7.0, 8.0, 9.0)
Start-stop synchronization	Start-stop bit length	Start bit: 1 bit, Stop bit: 1, 1.5, and 2 bits
	Data length	5, 6, 7 and 8 bits
	Parity	None, odd, even
Error measurement	Detection error	Bit error, code error, parity error, CRC error and frame mismatch are selected.
	Measurement items	Error count, error rate, block error count, block error rate, ES, %ES, DM, %DM, SES, %SES, US, %US, EFS, %EFS, AT, %AT, BBER clock slip, sync count/time, frame sync loss time, signal loss, AC power failure time
	Block length	2^5 to 2^{16} bits or 10^1 to 10^{16} bits
	Measurement time	10^2 to 10^9 bits measurement and repetition of 1 s to 999 hr 59 min. 59 s
	Display of measurement results	Among the measurement results, five or all optional items can be displayed simultaneously. The buzzer sounds if an error is detected (the volume can be adjusted). The lapse time after the measurement starts is displayed in units of seconds.
Pattern trace	No. of trace bytes	32 KB max.
	Traces stop trigger	Manual code detection, not code detection, signal lines ON/OFF, No. of trace bytes, external input signal ON/OFF
	Delay trace after trigger detection	10 to 8000 bytes
	Trace data display	Displays together with trace stop time in HEX, JIS8, ASCII, EBCDIC, EBCDIK, EBCD, Baudot bit (shift: +4 to -3 bits)
Voltage measurement	Measuring range: -30 to +30 V Accuracy: $\pm 5\% \pm 1$ digit	
Frequency measurement and count	Measuring range: DC to 10 MHz Accuracy: ± 5 ppm ± 1 digit Display: Decimal 7 digits	
Time measurement*3	Measuring range: 0 to 10 sec. (10 μ s steps) except for ASYNC and ST/SP Accuracy: ± 5 ppm ± 1 digit Display: Decimal 7 digits	
Signal monitor lamp	Displays the status of each signal line ("1"/"ON" : green or red*2, "0"/"OFF": lamp off)	
External output	Error: Negative logic, TTL level (half clock with of receiving clock) Pattern sync loss: Negative logic, TTL level Clock: Receiving gate clock, TTL level Receiving clock: TTL level (64 k + 8 k) b/s clock: 64 kb/s clock with 8 kb/s violation, AMI, RZ, 1.0 V $\pm 10\%$, Impedance: 120 Ω Video output: Composite video signal (vertical: 16.666 ms ± 100 ppm, horizontal: 63.61 μ s ± 100 ppm, 1 Vp-p $\pm 10\%$)	
External input	Clock: 50 b/s to 10 Mb/s, TTL (64 k + 8 k) b/s clock: 64 kb/s clock with 8 kb/s violation, AMI/RZ, Input level: 0.6 to 1.1 Vp-p, Impedance: 110 Ω Trigger: TTL level	
Print output	Printing in error measurement	At measurement start: Prints measurement conditions and time During measurement Print time, error count and alarm generation/recovery information at specified intervals Prints time and measurement result after start of measurement Prints time and error count at termination of each measurement cycle At measurement end: Prints time and measurement result
	Other printing	Prints measurement conditions, measurement results, and time in manual measurement
Internal timer	Year, month, day, hour, minute, second	
Power	85 to 132 Vac/170 to 250 Vac (changeable), 47 to 64 Hz, ≤ 180 VA (with full units)	
Operating temperature range	0° to 40°C	
Connectable unit	5 units max.	
Dimensions and mass	319 (W) x 177 (H) x 450 (D) mm, ≤ 10.5 kg	

*1: Up to 20 kb/s for ASYNC and STSP

*2: Denotes red LED alarm

*3: Can not measure delay time for async system and start-stop system

Ordering information

Please specify model/order number, name, and quantity when ordering.

MD6420A (main frame)

Model/Order No.	Name
MD6420A	Main frame Data Transmission Analyzer
	Standard accessories
	Power cord, 2.6 m: 1 pc
F0013*	Fuse, 5 A: 2 pcs
F0012*	Fuse, 3.15 A: 2 pcs
B0301	Protection cover: 1 pc
Z0031A	Printer paper: 2 rolls
B0254C	Blank panel (for interface units): 5 pcs
B0254D	Blank panel (for remote control units): 1 pc
W0618AE	MD6420A operation manual: 1 copy
	Options
MD6420A-01	Sending pattern synchronized signal output (video output cannot be used with this option.)
MD6420A-02	Sending pattern for word memory, 32 KB
	Optional accessories
B0291B	Carrying case (with casters)
B0251F	Shoulder bag (for MD6420A)
B0302	Rack mount kit
B0251E	Unit housing case (accommodates 10 units)
A0006	Headset
J0386	Probe for external input (BNC-P · IC clip), 2 m
J0315	Balanced cord (I-214APS · - · M-1PS), 2 m
J0612B	Balanced cord (M-3912 · - · M-3912), 2 m
J0050B	Balanced cord [M-214S · - · M-214S (shielded)], 2 m
J0127B	Coaxial cable (BNC-P · RG-58A/U · BNC-P)
J0106	Coaxial cable (3CV-P2 · M-1P), 2 m
Z0174	Service kit for MD6420A
J0673A	Double-ended 25 pin cross cable, 3 m

*: Supplied one kind of fuse depending on the power supply voltage specified when ordering.

Interface units

Model/Order No.	Name
MD0621A	V.24/V.28 (RS-232C) Interface Unit
W0595AE	Standard accessory MD0621A operation manual: 1 copy
	Optional accessories
J0387	Double-ended 25-pin connector cable, 2 m
J0388	25-pin DCE-DTE conversion adapter (used for DTE mode)
MD0621B	V.35 Interface Unit
W0596AE	Standard accessory MD0621B operation manual: 1 copy
	Optional accessories
J0864B	Double-ended 34-pin connector cable, 2 m
J0390	34-pin DCE-DTE conversion adapter (used for DTE mode)
MD0621C	V.36 (RS-449) Interface Unit
W0597AE	Standard accessory MD0621C operation manual: 1 copy
	Optional accessory
J0391	Double-ended 37-pin connector cable, 2 m
J0392	37-pin DCE-DTE conversion adapter (used for DTE mode)
MD0621D	X.20 (RS-423)/X.21 (RS-422) Interface Unit
W0598AE	Standard accessory MD0621D operation manual: 1 copy
	Optional accessory
J0393	Double-ended 15-pin connector cable, 2 m
MD0622B	G.703/G.704 1.544 Mb/s Bipolar Interface Unit
W0599AE	Standard accessory MD0622B operation manual: 1 copy
	Optional accessories
J0393	Double-ended 15-pin connector cable, 2 m
J0440	Balanced cord (CS1-MM2), 2 m
J0990	Measurement cable (D-SUB15/SBMD06FBS), 2 m
J0991	Measurement cable (D-SUB15/CLIP), 2 m

Model/Order No.	Name
MD0622D	G.703/G.704 6.312 Mb/s Bipolar Interface Unit
W0600AE	Standard accessory MD0622D operation manual: 1 copy
	Optional accessories
J0393	Double-ended 15-pin connector cable, 2 m
J0127B	Coaxial cord (BNC-P · RG58A/U · BNC-P), 1 m
MD0622E	G.703 64 kb/s Interface Unit
W0601AE	Standard accessory MD0622E operation manual: 1 copy
	Optional accessories
J0162A	Balanced cord (M-3912 · - · M-3912), 1 m
J0162B	Balanced cord (M-3912 · - · M-3912), 2 m
J0162C	Balanced cord (M-3912 · - · M-3912), 2.5 m
J0162D	Balanced cord (M-3912 · - · M-3912), 5 m
J0537	Balanced cord (M-3912 · - · M-1PS), 2 m
J0164	Balanced cord (M-3912 · - · M-214-SP), 2 m
J0440	Balanced cord (CS1-MM2), 2 m
MD0623A	G.703/G.704 2.048 Mb/s Bipolar Interface Unit (120 Ω balanced)
MD0623A1	G.703/G.704 2.048 Mb/s Bipolar Interface Unit (75 Ω balanced)
W0602AE	Standard accessory MD0623A/A1 operation manual: 1 copy
	Optional accessories
J0393	Double-ended 15-pin connector cable, 2 m
J0440	Balanced cord (CS1-MM2), 2 m
J0442	120 Ω/75 Ω adapter (balanced/unbalanced converter)
J0127B	Coaxial cable (BNC-P · RG-58A/U · BNC-P), 2 m
MD0623B	G.703/G.741 8.448 Mb/s Bipolar Interface Unit
W0603AE	Standard accessory MD0623B operation manual: 1 copy
	Optional accessory
J0127B	Coaxial cord (BNC-P · RG-58A/U · BNC-P), 2 m
MD0625B	I.431 1.544 Mb/s Interface Unit
W0606AE	Standard accessory MD0625B operation manual: 1 copy
	Optional accessories
J0393	Double-ended 15-pin connector cable (GMP-AS12-001), 2 m
J0440	Balanced cord, CS1-MM2, 2 m
J0539	Cable with 15-pin and modular connectors, (ISO4903 · 15P-IS8877 · 8P), 3 m
J0540	Cable with 15-pin connector and screw terminals, [ISO4903 · 15P-4 screw terminals (3 mm)], 3 m
J0594	Cable with 8-pin modular connector, and alligator clip, ISO8877-8P alligator, 2 m
MD0625C	I.431 2.048 Mb/s Interface Unit (120 Ω balanced)
MD0625C1	I.431 2.048 Mb/s Interface Unit (75 Ω balanced)
W0607AE	Standard accessory MD0625C/C1/C2 operation manual: 1 copy
	Optional accessories
J0393	Double-ended 15-pin connector cable (GMP-AS12-001), 2 m
J0440	Balanced cord (CS1-MM2), 2 m
J0442	120 Ω/75 Ω adapter (balanced/unbalanced converter)
J0539	Cable with 15-pin and modular connectors, (ISO4903 · 15P-IS8877 · 8P), 3 m
J0127B	Coaxial cable (BNC-P · RG58A/U · BNC-P), 2 m
J0540	Cable with 15-pin connector and screw terminals, [ISO4903 · 15P-4 screw terminals (3 mm)], 3 m
MD0626A	TTL Interface Unit
W0608AE	Standard accessory MD0626A operation manual: 1 copy
	Optional accessory
J0127B	Coaxial cable (BNC-P · RG-58A/U · BNC-P), 2 m
J0386	Probe for external input (BNC-P · IC clip)

Continued on next page

Model/Order No.	Name
MD0628B	DS1 Interface Unit
W0610AE	Standard accessory MD0628B operation manual: 1 copy
J0167B	Optional accessory Balanced cord (WECO310 · · · WECO310), 2 m
MD0628C	DS1C Interface Unit
W0611AE	Standard accessory MD0628C operation manual: 1 copy
J0167B	Optional accessory Balanced cord (WECO310 · · · WECO310), 2 m

Remote control units

Model/Order No.	Name
MD0620A	GPIB Remote Control Unit (The operation is described in the MD6420A operation manual.)
J0008	Optional accessory GPIB cable, 2 m
MD0620B	RS-232C Remote Control Unit (The operation is described in the MD6420A operation manual.)
J0387	Optional accessories Double-ended 25-pin connector cable, 2 m
J0673A	Double-ended 25-pin cross cable, 3 m

Extension units

Model/Order No.	Name
MD0627A	Analog Unit
W0609AE	Standard accessory MD0627A operation manual: 1 copy
J0135	Optional accessory Balanced cord (I-214APS · · · M-1PS), 2 m
MD0630A	Distortion Measurement Unit
W0614AE	Standard accessory MD0630A operation manual: 1 copy
MD0630B	CODEC Unit
W0614AE	Standard accessory MD0630B operation manual: 1 copy
J0127B	Optional accessories Coaxial cable (BNC-P · RG58A/U · BNC-P), 2 m
J0050B	Balanced cord [M-214S · · · M-214S (shielded)], 2 m
MA29A	75 Ω/600 Ω Conversion Transformer (for self-returning of voice output)
MD0632A	64 kb/s Jitter Unit
W0616AE	Standard accessory MD0632A/B/C operation manual: 1 copy
J0127B	Optional accessory Coaxial cable (BNC-P · RG58A/U · BNC-P), 2 m
MD0632B	1.544 Mb/s Jitter Unit
W0616AE	Standard accessory MD0632A/B/C operation manual: 1 copy
J0127B	Optional accessory Coaxial cable (BNC-P · RG58A/U · BNC-P), 2 m
MD0632C	2.048 Mb/s Jitter Unit
W0616AE	Standard accessory MD0632A/B/C operation manual: 1 copy
J0127B	Optional accessory Coaxial cable (BNC-P · RG58A/U · BNC-P), 2 m
MD0633A	Error Analyzer Unit (1 MB, RAM: 512 KB, memory card: 512 KB)
W0617AE	Standard accessory MD0633A operation manual: 1 copy
P0008	Optional accessories Plug-in memory card (256 KB)
P0009	Plug-in memory card (512 KB)
MD0610D	Word Memory Unit (8 KB)
MD0610D1	Word Memory Unit (32 KB)
W0143AE	Standard accessory MD0610D/D1 operation manual: 1 copy



DIGITAL MOBILE COMMUNICATIONS MEASURING INSTRUMENTS

Selection Guide	206
Digital Mobile Radio Transmitter Testers	207, 213, 220
Digital Modulation Signal Generators	230, 237, 248
W-CDMA Signalling Tester	251
Signalling Testers	254, 256
<i>Bluetooth</i> Test Set	259
Radio Communication Analyzers	265, 269
W-CDMA Area Tester	278
Radio Communication Test System	281
W-CDMA Virtual Signaling Test System	286
Measuring Receiver	289
Error Rate Tester	289

Mobile communication measurement equipment

(example of an application; various other types of measurement equipment are also available)

Type of measurement equipment	Communication system														Anritsu model	Equipment to be measured																									
	Digital															Mobile equipment				Base station																					
	8PSK	GMSK	GFSK	π/4 DQPSK			CDMA		π/4 DQPSK			M-16QAM				Transmitter	Receiver	Signalling	Maintenance, troubleshooting	Transmitter	Receiver	Signalling	Construction, maintenance	Service areas	Entrance circuitry	Parts															
	Europe etc.				USA				Japan																																
	EDGE	GSM	PCN (DCS1800)	CT2	DECT	TFTS	TETRA	NADC	PACS	WCPE	CDMA (IS-95)	CDMA (ARIB STD-T53)	W-CDMA	PDC		PHS	RCR STD-39	DMCA	Analog																						
Radio communication analyzer	√	√					√			√	√		√	√			√	√	√	√				√	MT8801C	√	√	√	√	√	√									√	
													√												√	MT8820A	√	√	√	√										√	
Digital mobile radio transmitter tester	√	√											√											√	MS8608A/8609A	√				√				√					√		
		√	√	√	√	√	√	√	√	√				√	√	√	√							√	MS8604A	√				√				√				√			
Time-domain-capable spectrum analyzer		√	√	√	√	√	√	√	√	√	√	√	√	√	√	√	√							√	MS2661B/C, MS2663C, MS2665C, MS2667C, MS2668C	√	√			√	√			√	√		√	√			√
	√	√	√	√	√	√	√	√	√	√	√	√	√	√	√	√	√	√						√	MS2683A	√	√		√	√			√	√		√	√		√		
Digital modulation signal generator													√											√	MG3681A		√		√		√		√					√			
		√	√	√	√	√	√	√	√	√	√	√	√	√	*	*								√	MG3670B/C, MG3671A/B		√		√		√		√				√				
		√	√	√	√	√	√	√	√	√	√	√	√	√	*	*								√	MG3672A		√		√		√		√				√				
		√	√	√	√	√	√	√	√	√	√	√	√	√										√	MG3660A		√		√		√		√		√		√				
Signalling tester													√											√	MD1620B			√	√									√			
																								√	MD1620C*			√	√			√					√				
													√											√	MD8480A			√	√								√				
Radio communication test system											√	√		√	√								√	ME7812 series	√	√	√	√									√				
Error rate tester		√	√	√	√	√	√	√	√				√	√	√	√							√	MP1201C		√			√		√		√			√					
		√	√	√	√	√	√	√	√				√	√	√	√							√	MD6420A		√			√		√		√			√					
Signal generator		√	√	√	√	√	√	√	√				√										√	MG3641A		√			√		√		√			√					
		√	√	√	√	√	√	√	√	√	√	√	√	√	√	√	√						√	MG3642A		√			√		√		√			√					
		√	√	√	√	√	√	√	√	√	√	√	√	√	√	√	√						√	MG3633A		√			√		√		√			√					
		√	√	√	√	√	√	√	√	√	√	√	√	√	√	√	√							√	68000C, 69000B		√			√		√		√			√				
Power meter		√	√	√	√	√	√	√	√	√	√	√	√	√	√	√							√	ML2437A/2438A	√				√		√		√			√					
		√	√	√	√	√	√	√	√	√	√	√	√	√	√	√							√	ML2407A/2408A	√				√		√		√			√					
Frequency counter		√	√	√	√	√	√	√	√	√	√	√	√	√	√	√							√	MF2400B series	√				√		√		√			√					
Measuring receiver													√										√	ML5655C									√		√						
		√																					√	ML524B*									√		√						
Site master		√	√	√	√	√	√	√	√	√	√	√	√	√	√	√							√	S331B									√								
Network analyzer		√	√	√	√	√	√	√	√	√	√	√	√	√	√	√							√	54100A series									√			√					
		√	√	√	√	√	√	√	√	√	√	√	√	√	√	√							√	MS4630B	√	√			√	√						√					
		√	√	√	√	√	√	√	√	√	√	√	√	√	√	√							√	37200C series	√	√			√	√						√					
Area tester												√											√	ML8720B									√		√						

*: Custom-made product

DIGITAL MOBILE RADIO TRANSMITTER TESTER

MS8609A

9 kHz to 13.2 GHz

Measures Wide-Band Signals up to IMT-2000 2 Mbit/s

NEW



CE GPIB

The MS8609A is a transmitter tester equipped with an internal spectrum analyzer, a modulation analyzer and a power meter. One tester covers the development, manufacturing of base stations, mobile stations to construction, maintenance of base stations.

The spectrum analyzer has resolution bandwidths up to 20 MHz, meaning that it can readily support measurement of a 2 Mbit/s (16 Mcps) wide-band signal for IMT-2000.

The modulation analyzer realizes all Vector Signal Analysis (VSA) functions through high-speed DSP. The power sensor can perform highly accurate power measurements of ± 0.4 dB by using an amorphous power sensor.

Up to three dedicated measurement software options (such as W-CDMA and GSM/EDGE) can be installed simultaneously. Input signals can be selected from either RF or I/Q inputs. For I/Q signals, balanced or unbalanced input can also be selected.

It is equipped with GPIB, RS-232C and 10 Base-T (optional) interfaces for remote measurement. High-speed GPIB data transmission of 120 kbyte/s enables high-speed measurement on the manufacturing line. The monitor uses an easy-to-see 6.5 type TFT color LCD.

MX860901B W-CDMA Measurement Software

• Parameter setup

The measurement parameters such as modulation accuracy and code domain power are set on the screen shown below.

Measurement are simply performed via a soft-key menu after setting the measurement parameters.

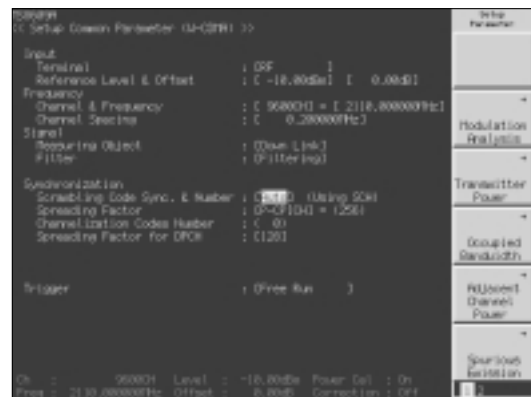

• Base station code domain power

Only 3 seconds are required for measurement. Either automatic detection of scrambling code from SCH, or specification of scrambling code can be selected.

• Modulation accuracy measurement

The modulation accuracy of base station and mobile equipment can be measured and modulation analysis of multiple waveforms can be performed. The residual vector error (rms) accuracy is high (1%, typical).

• Mobile terminal code domain power

Displays the code domain power measurement results of phase I and phase Q, separately. Either synchronization with DPCCCH or specification of spreading factor and code can be selected.

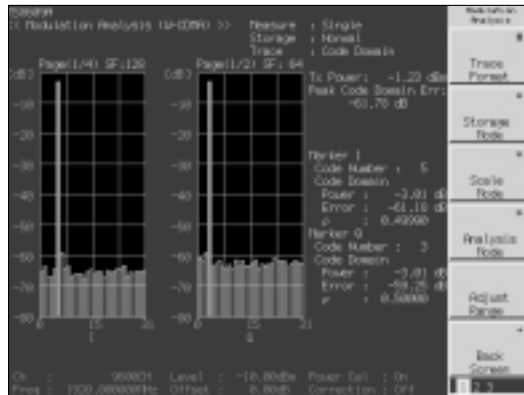

• I/Q level measurement

Measures and displays each I and Q input voltage (rms, p-p value). dBmV or mV units are selectable.

• Spectrum analyzer function

This analyzer has a wide dynamic range and various useful measurement functions.

• Power meter function

The built-in power meter uses the amorphous power sensor and the measurement accuracy is very high (± 0.4 dB).

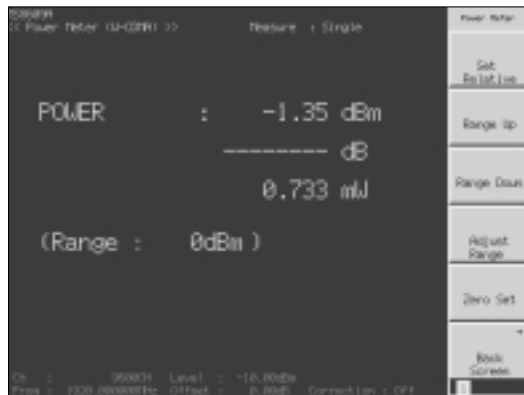

• Demodulation data monitoring

After de-spreading, up to 10 frames of I/Q data can be evaluated with external application software. (Sample soft-ware can be provided.)

MX860902A GSM Measurement Software

• Parameter setup

The measurement parameters such as GMSK modulation of GSM and 8PSK modulation of EDGE are set on the screen shown below. Measurement are simply performed via a soft-key menu after setting the measurement parameters.

• Modulation accuracy measurement

The modulation accuracy is high. (The residual phase error of GMSK modulation: rms, $< 0.5^\circ$ and residual EVM of 8PSK modulation: rms, $< 1.0\%$)

• Transmitter power measurement

The screen displays the amplitude waveforms with horizontal axis a symbol, vertical axis a level and the template simultaneously.

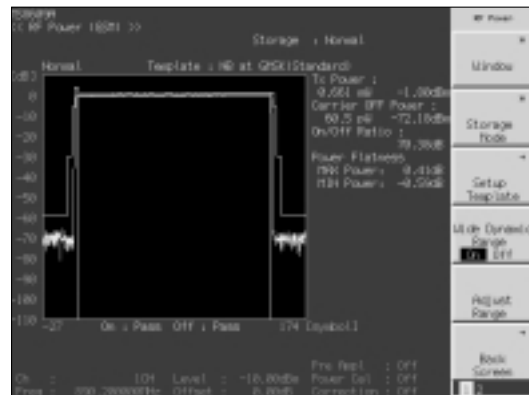

• Trellis display function

The screen displays the trellis and the modulation accuracy result simultaneously.

• Output RF spectrum measurement

The output RF spectrum measurement can be performed at high speed and simply.

• Spurious measurement

Spurious measurement has three kinds of method: Sweep, Search, and Spot. These can be selected depending on the usage.

• EDGE constellation display

The following screen represents constellation display through the filter of the EDGE constellation display of the GSM standard. And the screen represents constellation display of the 8PSK modulation through Nyquist filter and Gaussian inverse correction filter.

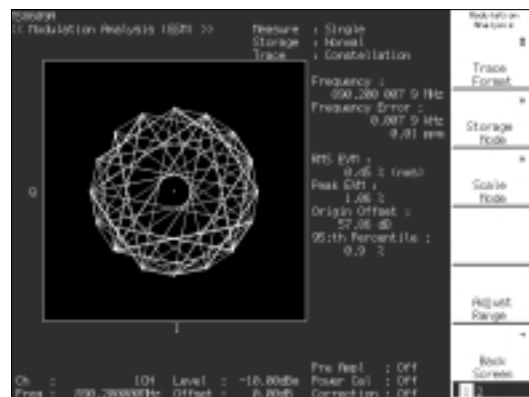

Specifications

• MS8609A

Frequency range	9 kHz to 13.2 GHz	
Max. input level	+20 dBm (100 mW), continuous average power	
Input impedance	Power meter 50 Ω, VSWR: ≤1.3 (30 MHz to 3 GHz) Except power meter 50 Ω, VSWR: ≤1.5 (input attenuator: ≥4 dB, ≤3 GHz)/≤2.3 (input attenuator: ≥10 dB, >3 GHz)	
Input connector	N-type	
Reference oscillator	Frequency: 10 MHz Starting characteristics: ≤5 x 10 ⁻⁸ /day (after 10 minute warm-up, compared to frequency after 24 hour warm-up) Aging rate: ≤2 x 10 ⁻⁸ /day, ≤1 x 10 ⁻⁷ /year (compared to frequency after 24 hour warm-up) Temperature characteristics: ±5 x 10 ⁻⁸ (0° to 50°C, compared to frequency at 25°C)	
Power meter	Frequency range: 30 MHz to 3 GHz Level range: -20 to +20 dBm Measurement accuracy (after zero calibration): ±10%	
Spectrum analyzer	Frequency	Frequency setting Setting range: 9 kHz to 13.2 GHz, Pre-selector range: 3.15 to 13.2 GHz (Band 1 and 2) Frequency accuracy Accuracy: ± (display frequency x reference frequency accuracy + span x span accuracy + resolution bandwidth x 0.15 + 10 x N Hz) Normal marker: Same as display frequency accuracy Delta marker: Same as span accuracy Frequency span setting range: 0 Hz, 5 kHz to 13.2 GHz Span accuracy: ±1.0% (at single band sweep, number of data points: 1001) RBW (resolution bandwidth) Setting range: 300 Hz to 3 MHz (1-3 sequence), 5 MHz, 10 MHz, 20 MHz (Band 0) Accuracy: ±20% (300 Hz to 10 MHz), ±40% (20 MHz) Selectivity (60 dB: 3 dB): ≤15:1 VBW (video bandwidth): 1 Hz to 3 MHz (1-3 sequence), off Sideband noise: ≤-108 dBc/Hz (1 GHz, 10 kHz offset), ≤-120 dBc/Hz (1 GHz, 100 kHz offset)
	Amplitude	Maximum input level Continuous average power: +20 dBm, DC voltage: 0 V Average noise level (RBW: 300 Hz, VBW: 1 Hz): [Without Option 08] ≤-124 dBm + 1.5 x f [GHz] dB (1 MHz to 2.5 GHz, Band 0) ≤-120 dBm + 1.5 x f [GHz] dB (2.5 to 3.2 GHz, Band 0) ≤-116 dBm (3.15 to 7.8 GHz, Band 1) ≤-107 dBm (7.7 to 13.2 GHz, Band 2) [With Option 08] ≤-122 dBm + 1.8 x f [GHz] dB (1 MHz to 2.5 GHz, Band 0) ≤-120 dBm + 1.8 x f [GHz] dB (2.5 to 3.2 GHz, Band 0) ≤-116 dBm (3.15 to 7.8 GHz, Band 1) ≤-107 dBm (7.7 to 13.2 GHz, Band 2) Residual response: ≤-100 dBm (1 MHz to 3.2 GHz, Band 0), ≤-90 dBm (3.15 to 7.8 GHz, Band 1) Reference level Setting range: -100 to +30 dBm Accuracy: ±0.75 dB (+0.1 to 20 dBm), ±0.5 dB (-49.9 to 0 dBm), ±0.75 dB (-69.9 to -50 dBm), ±1.5 dB (-80 to -70 dBm) *After calibration, frequency: 50 MHz, span: 1 MHz (Input attenuator, RBW, VBW and sweep time are set to AUTO.) Input attenuator: 0 to 62 dB (2 dB steps) Frequency response: ±0.6 dB (9 kHz to 3.2 GHz, Band 0), ±1.5 dB (3.15 to 7.8 GHz, Band 1*), ±2.0 dB (7.7 to 13.2 GHz, Band 2*) Log linearity: ±0.4 dB (0 to -20 dB, RBW: ≤1 kHz), ±1.0 dB (0 to -90 dB, RBW: ≤1 kHz) 2nd harmonic distortion: ≤-60 dBc (10 to 200 MHz), ≤-75 dBc (200 to 850 MHz, Band 0), ≤-70 dBc (0.85 to 1.6 GHz, Band 0), ≤-90 dBc (1.6 to 6.6 GHz, Band 1 and 2) Two-tone 3rd order distortion: ≤-70 dBc (10 to 100 MHz), ≤-85 dBc (0.1 to 3.2 GHz), ≤-80 dBc (3.15 to 7.8 GHz), ≤-75 dBc (7.7 to 13.2 GHz) *Frequency difference of two signals: ≥50 kHz, mixer input: -30 dBm 1 dB gain compression: ≥0 dBm (≥100 MHz), ≥+3 dBm (≥500 MHz, Band 0), ≥-3 dBm (≥3150 MHz, Band 1 and 2)
	Sweep	Setting range: 10 ms to 1000 s (frequency axis sweep), 1 μs to 1000 s (time axis sweep) Trigger switch: Free-run, triggered Trigger source: Wide IF video, Line, External (TTL level), External (±10 V) Trigger delay Pre-trigger range: -time span to 0 s Resolution: time span/500 or 100 ns whichever is larger. Post trigger: 0 μs to 65.5 ms Resolution: 100 ns (sweep time: ≤4.9 ms), 1 μs (sweep time: ≥5 ms) Gate sweep mode Gate delay range: 0 to 65.5 ms (resolution: 1 μs), Gate length range: 2 μs to 65.5 ms (resolution: 1 μs)

Continued on next page

Spectrum analyzer	Functions	<p>Number of data points: 501, 1001</p> <p>Detection modes: Normal, Positive peak, Negative peak, Sample, Average, rms (Option 04)</p> <p>Display functions: Trace A, Trace B, Trace A/B, Trace A/BG, Trace A/Time</p> <p>Storage functions: Normal, View, Max hold, Min hold, Average, Linear average, Cumulative, Overwrite</p> <p>Markers</p> <p>Signal search: Auto tune, Peak → CF, Peak → Ref, Scroll</p> <p>Zone markers: Normal, Delta</p> <p>Marker function: Marker → CF, Marker → Ref, Marker → CF step size, Δ marker → Span, Zone → Span</p> <p>Peak search: Peak, Next peak, Min dip, Next dip</p> <p>Multi-marker: 10 max.</p> <p>Measurements</p> <p>Noise power: dBm/Hz, dBm/ch, $\text{dB}\mu\sqrt{\text{Hz}}$</p> <p>C/N: dBc/Hz, dBc/ch</p> <p>Occupied bandwidth: Power N% method, X-dB down method</p> <p>Adjacent channel power</p> <p>Reference measurement: Total power, reference level, in-band method</p> <p>Display methods: Channel specified display (3 channels x 2), graphic display</p> <p>Average power of burst signal: Average power within specified time range of time domain waveform</p> <p>Template comparison measurement (time sweep): Upper limit x 2, lower limit x 2</p> <p>Mask measurement (frequency sweep): Upper limit x 2, lower limit x 2</p>
Others		<p>Display: Color TFT-LCD, VGA 6.5 type</p> <p>Hard copy: Hard copy of screen via parallel interface (ESC/P compatible printer)</p> <p>Memory card interface: ATA flash card (3.3/5V)</p> <p>GPIO:</p> <p>Can be controlled from external controller (except power switch) when specified as device</p> <p>Interface functions: SH1, AH1, T6, L4, SR1, RL1, PP0, DC1, DT1, C0, E2</p> <p>Parallel interface: Centronics printer I/F, D-sub 25-pin connector (female)</p> <p>Video output: Analog RGB output, D-sub 15-pin connector (female)</p>
Dimensions and mass		320 (W) x 177 (H) x 411 (D) mm (except handle, feet, front cover and fan cover), ≤16 kg (nominal)
Power		100 to 120/200 to 240 Vac (−15/+10%, max. voltage: 250 V, automatic voltage selection), 47.5 to 63 Hz, ≤400 VA
Operating temperature and humidity		0° to 50°C, ≤85% (no condensation)
EMC		EN61326: 1997/A1: 1998 (Class A), EN61000-3-2: 1995/A2: 1998 (Class A), EN61326: 1997/A1: 1998 (Annex A)
LVD		EN61010-1: 1993/A2: 1995 (Installation Category II, Pollution degree 2)

*1: Reference frequency: 50 MHz, input attenuator: 10 dB, 18° to 28°C

• MX860901B W-CDMA Measurement Software

Guaranteed specifications after Adjust Range and Power Calibration keys pressed

Modulation/frequency measurement	<p>Frequency range: 50 MHz to 3 GHz, 50 MHz to 2.3 GHz (Option 08)</p> <p>Input level: −60 to +20 dBm (average power, pre-amplifier: off), −80 to +10 dBm (average power, pre-amplifier: on*)</p> <p>Carrier frequency accuracy: ±(reference oscillator accuracy + 10 Hz)</p> <p>*Input level: ≥−30 dBm (pre-amplifier: off), ≥−40 dBm (pre-amplifier: on*), 1 code channel</p> <p>Modulation accuracy (residual vector error): <2% (rms)</p> <p>*Input level: ≥−30 dBm (pre-amplifier: off), ≥−40 dBm (pre-amplifier: on*), 1 code channel</p> <p>Origin offset accuracy: ±0.5 dB</p> <p>*Input level: ≥−30 dBm (pre-amplifier: off), ≥−40 dBm (pre-amplifier: on*), 1 code channel, relative to signal with origin offset of −30 dBc</p> <p>Waveform display (for one-channel to multi-channel)</p> <p>Constellation display, vector error vs. chip, phase error vs. chip, amplitude error vs. chip</p>
Code domain analysis	<p>Frequency range: 50 MHz to 3 GHz, 50 MHz to 2.3 GHz (Option 08)</p> <p>Input level: −60 to +20 dBm (average power, pre-amplifier: off), −80 to +10 dBm (average power, pre-amplifier: on*)</p> <p>Code domain power accuracy:</p> <p>±0.1 dB (code power: ≥−10 dBc), ±0.3 dB (code power: ≥−25 dBc)</p> <p>*Input level: ≥−10 dBm (pre-amplifier: off), ≥−20 dBm (pre-amplifier: on*)</p> <p>Code domain error</p> <p>Residual error: <−50 dB</p> <p>Accuracy: ±0.5 dB (error: relative to signal with origin offset of −30 dBc)</p> <p>*Input level: ≥−10 dBm (pre-amplifier: off); ≥−20 dBm (pre-amplifier: on*), spread factor: 512 (down-link)/256 (up-link)</p> <p>Display</p> <p>Function: Code domain power, code domain error</p> <p>Spread factor: 4 to 256 (up-link)/4 to 512 (down-link), spread factor auto detection function, I/Q separately at up-link</p>
Amplitude measurement	<p>Frequency range: 50 MHz to 3 GHz, 50 MHz to 2.3 GHz (Option 08)</p> <p>Input level: −60 to +20 dBm (average power, pre-amplifier: off), −80 to +10 dBm (average power, pre-amplifier: on*)</p> <p>Transmitter power measurement</p> <p>Measurement range: −20 to +20 dBm (average power, pre-amplifier: off), −20 to +10 dBm (average power, pre-amplifier: on*) *Auto calibrated at internal power meter</p> <p>Accuracy: ±0.4%</p> <p>Power measurement linearity:</p> <p>±0.2 dB (0 to −40 dB) *Input level: ≥−10 dBm (pre-amplifier: off); ≥−20 dBm (pre-amplifier: on*), after the range adjusted, with the reference level setting unchanged</p> <p>Filter selection function: Power measurement through RRC ($\alpha=0.22$) filter</p> <p>Transmitter power control measurement function: Relative power per slot, NO/GO evaluation</p>
Occupied bandwidth measurement	<p>Frequency range: 50 MHz to 3 GHz</p> <p>Input level: −60 to +20 dBm (average power, pre-amplifier: off), −80 to +10 dBm (average power, pre-amplifier: on*)</p> <p>Measurement method</p> <p>Sweep method: Displays result after signal measured with sweep spectrum analyzer</p> <p>FFT method: Displays result after FFT</p>

Continued on next page

Adjacent channel power measurement	<p>Frequency range: 50 MHz to 3 GHz, 50 MHz to 2.3 GHz (Option 08) Input level: -10 to +20 dBm (average power, pre-amplifier: off) Measurement method Sweep method (all): Calculates and displays result after signal measured with sweep spectrum analyzer Sweep method (separate): Calculates and displays power after each adjacent channel measured with sweep spectrum analyzer Filter method: Measures and displays power of adjacent channels after passing via built-in receiving filters (RRC: $\alpha = 0.22$) Measurement range Input level: ≥ 0 dBm (filter method, wide dynamic range mode) Code channel (1 code): ≥ 55 dBc (5 MHz offset), ≥ 62 dBc (10 MHz offset) Code channel (16 multi-code): ≥ 50 dBc (5 MHz offset), ≥ 60 dBc (10 MHz offset, without Option 08) Input level: ≥ -10 dBm (filter method, wide dynamic range mode) Code channel (1 code): 55 dBc (5 MHz offset, typical), 62 dBc (10 MHz offset, typical) Code channel (16 multi-code): 50 dBc (5 MHz offset, typical), 60 dBc (10 MHz offset, typical)</p>
Spurious measurement	<p>Measurement frequency: 9 kHz to 12.75 GHz (except within carrier frequency ± 50 MHz) Input level (transmitter power): 0 to +20 dBm (average power, pre-amplifier: off) Measurement method Sweep method: Sweeps the specified range of frequency using the spectrum analyzer, and then detects and displays the peak value. Calculates the rate for transmission power value and displays it as power rate. Waveform detection mode: average Spot method: Measures the specified frequency with time domain from the spectrum analyzer and then displays the average value. Calculates the rate for transmission power value and displays it as power rate. Waveform detection mode: average Search method: Sweeps the specified frequency range using the spectrum analyzer to detect the peak value, then measures the frequency using the time domain to display the average value. Calculates the rate for transmission power value and displays it as power rate. Waveform detection mode: average Measurement range*2: ≥ 79 dB (RBW: 1 kHz, 9 to 150 kHz, Band 0) ≥ 79 dB (RBW: 10 kHz, 150 kHz to 30 MHz, Band 0) ≥ 79 dB (RBW: 100 kHz, 30 to 1000 MHz, Band 0) $\geq 76 - f$ [GHz] dB (RBW: 1 MHz, 1 to 3.15 GHz, Band 0) ≥ 76 dB (RBW: 1 MHz, 3.15 to 7.8 GHz, Band 1) *Carrier frequency: 1.8 to 2.2 GHz</p>
I/Q signal	<p>Input: Balanced, unbalanced Input impedance: 1 MΩ (parallel capacity: <100 pF), 50 Ω Balanced input Differential voltage: 0.1 to 1 V (p-p), In-phase voltage: ± 2.5 V Unbalanced input: 0.1 to 1 V (p-p), AC/DC switchable Measurement items: Modulation accuracy, code domain power, amplitude, occupied bandwidth (FFT method), I/Q level Residual vector error: <2% (rms) *Input level: ≥ 0.1 V (rms), DC coupling I/Q level measurement: Measures and displays each I, Q input voltage (rms, p-p) I/Q phase difference measurement: When the CW signal is inputted to I and Q input terminals, measures and displays the phase difference between I- and Q-phase signals.</p>

*1: Can be set when MS8609A-08 option is installed in the main unit.

*2: When carrier frequency is in a 2030.354 to 2200 MHz range, spurious will be generated at the frequency below.
 f (spurious) = f (input) - 2030.345 MHz

• MX860902A GSM Measurement Software

Guaranteed specifications after Adjust Range and Power Calibration keys pressed

Modulation/frequency measurement	<p>Frequency range: 50 MHz to 2.7 GHz Input level: -40 to +20 dBm (burst average power, pre-amplifier: off), -60 to +10 dBm (burst average power, pre-amplifier: on*1) Carrier frequency accuracy: \pm (reference oscillator accuracy + 10 Hz) *Input level (burst average power): ≥ -30 dBm (pre-amplifier: off), ≥ -40 dBm (pre-amplifier: on*1) Residual phase error (GMSK modulation): <0.5 deg (rms), <2.0 deg (peak) *Input level (burst average power): ≥ -30 dBm (pre-amplifier: off), ≥ -40 dBm (pre-amplifier: on*1) Residual EVM (8PSK modulation): <1% (rms) Waveform display: Trellis (GMSK modulation), eye pattern, EVM vs. bit (8PSK modulation), phase vs. bit, amplitude vs. bit, I/Q diagram</p>
Amplitude measurement	<p>Frequency range: 50 MHz to 2.7 GHz Input level: -40 to +20 dBm (burst average power, pre-amplifier: off), -60 to +10 dBm (burst average power, pre-amplifier: on*1) Transmitter power measurement (auto calibrated at internal power meter) Measurement range: -10 to +20 dBm (burst average power), -10 to +10 dBm (burst average power, pre-amplifier: on*1) Accuracy: ± 0.4 dB Power measurement linearity: ± 0.2 dB (0 to -30 dBm) *Input level (burst average power): ≥ -10 dBm (pre-amplifier: off); ≥ -20 dBm (pre-amplifier: on*1), without changing the reference level setting after range optimization Carrier-off power measurement range Input level (burst average power): ≥ -10 dBm (pre-amplifier: off), ≥ -20 dBm (pre-amplifier: on*1) Normal mode: ≥ 60 dB (compared with burst average power) Wide dynamic range mode: ≥ 80 dB (compared with 10 mW of burst average power) *Measurement limit is decided by average noise level (≤ -70 dBm, 50 MHz to 2.7 GHz). Rise/fall characteristics: Display rising/falling edges while synchronizing to modulation data of signal data to be measured. Standard line display possible (measured by 1 MHz bandwidth). NO/GO judgment function</p>

Continued on next page

Output RF spectrum measurement	<p>Frequency range: 100 MHz to 2.7 GHz</p> <p>Input level: -10 to +20 dBm (burst average power, pre-amplifier: off), -20 to +10 dBm (burst average power, pre-amplifier: on*)</p> <p>Modulation portion measurement range: ≥ 60 dB (≥ 200 kHz offset), ≥ 68 dB (≥ 250 kHz offset) *CW signal, RBW: 30 kHz (< 1.8 MHz offset), RBW: 100 kHz (≤ 1.8 MHz offset)</p> <p>Transient portion measurement range: ≥ 63 dB (CW, ≥ 400 kHz offset)</p>
Spurious measurement	<p>Measurement frequency: 100 kHz to 12.75 GHz (except within carrier frequency ± 50 MHz)</p> <p>Input level (transmitter power): 0 to +20 dBm (burst average power, pre-amplifier: off)</p> <p>Measurement method</p> <p>Sweep method: Sweeps the specified range of frequency using the spectrum analyzer, and then detects and displays the peak value. Calculates the rate for transmission power value and displays it as power rate. Waveform detection mode: average</p> <p>Spot method: Measures the specified frequency with time domain from the spectrum analyzer and then displays the average value. Calculates the rate for transmission power value and displays it as power rate. Waveform detection mode: average</p> <p>Search method: Sweeps the specified frequency range using the spectrum analyzer to detect the peak value, then measures the frequency using the time domain to display the average value. Calculates the rate for transmission power value and displays it as power rate. Waveform detection mode: average</p> <p>Measurement range: ≥ 72 dB (RBW: 10 kHz, 100 kHz to 50 MHz, Band 0) ≥ 72 dB (RBW: 100 kHz, 50 to 500 MHz, Band 0) $\geq 66 -f$ [GHz] dB (RBW: 3 MHz, 0.5 to 3.15 GHz, Band 0, except harmonic frequency) ≥ 66 dB (RBW: 3 MHz, 3.15 to 7.8 GHz, Band 1) *Carrier frequency: 0.8 to 1 GHz, 1.8 to 2 GHz</p>
I/Q signal	<p>Input: Balanced, unbalanced</p> <p>Input impedance: 1 MΩ (parallel capacity: < 100 pF), 50 Ω</p> <p>Balanced input Differential voltage: 0.1 to 1 V (p-p), In-phase voltage: ± 2.5 V</p> <p>Unbalanced input: 0.1 to 1 V (p-p), AC/DC switchable</p> <p>Measurement items: Modulation accuracy, I/Q level</p> <p>Modulation accuracy Residual phase error: < 0.5 deg (rms), DC coupling Residual EVM: $< 1.0\%$ (rms), DC coupling *Input level: ≥ 0.1 V (rms), 18° to 28°C</p> <p>I/Q level measurement: Measures and displays each I, Q input voltage (rms, p-p)</p> <p>I/Q phase difference measurement: When the CW signal is inputted to I and Q input terminals, measures and displays the phase difference between I- and Q-phase signals.</p>

*1: Can be set when MS8609A-08 option is installed in the main unit.

Ordering information

Please specify model/order number, name and quantity when ordering.

Model/Order No.	Name	Model/Order No.	Name
MS8609A	<p>Main frame</p> <p>Digital Mobile Radio Transmitter Tester</p> <p>Standard accessories</p> <p>Power cord, 2.6 m: 1 pc</p> <p>RS-232C cable: 1 pc</p> <p>PC-ATA card (32 MB): 1 pc</p> <p>Fuse, 6.3 A: 1 pc</p> <p>Coaxial cord (N-P · 5D-2W · N-P), 1 m: 1 pc</p> <p>File Transfer Utility: 1 pc</p> <p>MS8608A/8609A operation manual (Vol. 1): 1 copy</p> <p>MS8608A/8609A operation manual (Vol. 2): 1 copy</p> <p>MS8608A/8609A operation manual (Vol. 3): 1 copy</p> <p>Options</p> <p>Precision frequency reference (aging rate: 5×10^{-10}/day)</p> <p>Digital resolution bandwidth</p> <p>Rubidium reference oscillator</p> <p>Pre-amplifier</p> <p>Ethernet interface</p> <p>7.9 GHz frequency extension</p> <p>Auto-power recovery</p> <p>Rack mount without handle (JIS)</p> <p>Rack mount without handle (IEC)</p>	<p>Measurement software</p> <p>W-CDMA Measurement Software</p> <p>GSM Measurement Software</p> <p>MX860801B/860901B operation manual</p> <p>MX860802A/860902A operation manual</p> <p>Optional accessories</p> <p>Coaxial cord (N-P · 5D-2W · N-P), 2 m</p> <p>Coaxial cord (BNC-P · RG-58A/U · BNC-P), 0.5 m</p> <p>Coaxial cord (BNC-P · RG-58A/U · BNC-P), 1 m</p> <p> GPIB cable, 1 m</p> <p> GPIB cable, 2 m</p> <p>Four-Point Junction Pad (5 to 3000 MHz)</p> <p>High-power fixed attenuator (30 dB, 30 W, DC to 8 GHz)</p> <p>High-power fixed attenuator (30 dB, 100 W, DC to 18 GHz)</p> <p>Hard carrying case (with casters)</p> <p>Hard carrying case (without casters)</p> <p>Front cover (3/4 MW4U)</p> <p>Rear panel protective pad</p> <p>Maintenance service</p> <p>MS8609A-90 Extension service 3 years</p> <p>MS8609A-91 Extension service 5 years</p>	

DIGITAL MOBILE RADIO TRANSMITTER TESTER

MS8608A

9 kHz to 7.8 GHz

Transmitter Tester for W-CDMA 3GPP Specification

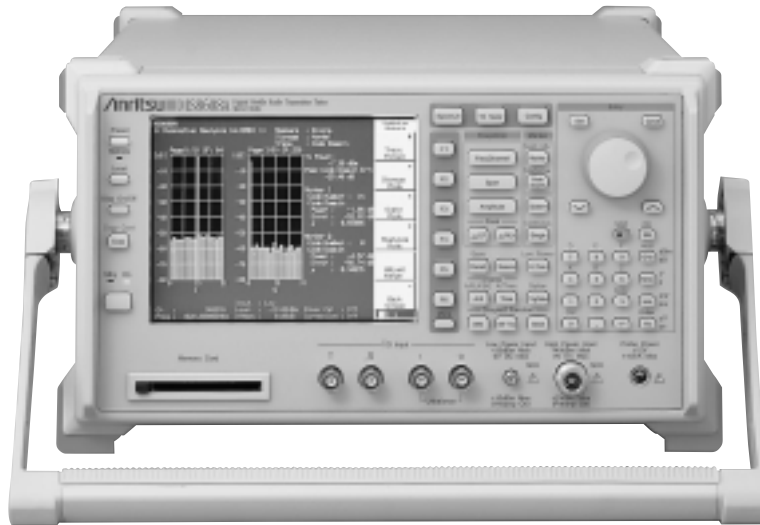

The MS8608A is a transmitter tester equipped with an internal spectrum analyzer, a modulation analyzer and a power meter. One tester covers the development to manufacturing of base stations, mobile stations and devices.

The spectrum analyzer has resolution bandwidths up to 20 MHz, meaning that it can readily support measurement of a 2 Mbit/s (16 Mcps) wide-band signal for IMT-2000.

The modulation analyzer realizes all Vector Signal Analysis (VSA) functions through high-speed DSP processing.

The power sensor can perform highly accurate power measurements of ± 0.4 dB by using an amorphous power sensor.

Up to three dedicated measurement software options (such as W-CDMA and GSM/EDGE) can be installed simultaneously.

Input signals can be selected from either RF or I/Q signals, balanced or unbalanced input can also be selected.

It is equipped with GPIB, RS-232C and 10 Base-T (optional) interfaces for remote measurement. High-speed GPIB data transmission of 120 kbyte/s enables high-speed measurement on the manufacturing line. The monitor uses an easy-to-see 6.5 type TFT color LCD.

Feature

- Broadband signal support (up to IMT-2000 2 Mbit/s)

MX860801B W-CDMA Measurement Software

• Parameter setup

The measurement parameters such as modulation accuracy and code domain power, etc. are set on the screen shown below. Measurement are simply performed via a soft-key menu after setting the measurement parameters.



• Base station code domain power

Only 3 seconds are required for measurement. Either automatic detection of scrambling code from SCH, or specification of scrambling code can be selected.

• Modulation accuracy measurement

The modulation accuracy of base station and mobile equipment can be measured and modulation analysis of multiple waveforms can be performed. The residual EVM (rms) accuracy is high (1%, typical).

• Mobile terminal code domain power

Displays the code domain power measurement results of phase I and phase Q, separately. Either synchronization with DPCCH or specification of spreading factor and code can be selected.

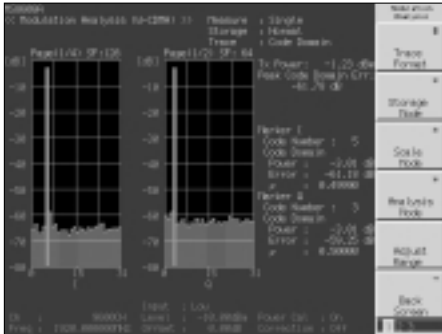

• Modulation accuracy measurement

The modulation accuracy is high. (The residual phase error of GMSK modulation: rms, <math><0.5^\circ</math> and residual EVM of 8PSK modulation: rms, <math><1.0\%</math>)

• Transmitter power measurement

The screen displays the amplitude waveforms with horizontal axis a symbol, vertical axis a level and the template simultaneously.

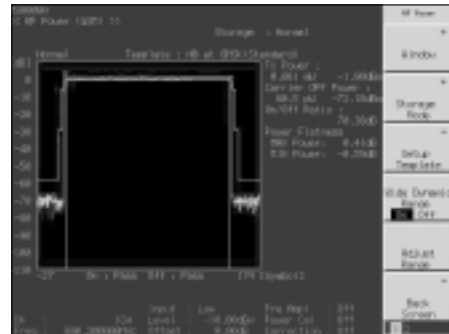

• Power meter function

The built-in power meter uses the amorphous power sensor and the measurement accuracy is very high (± 0.4 dB).

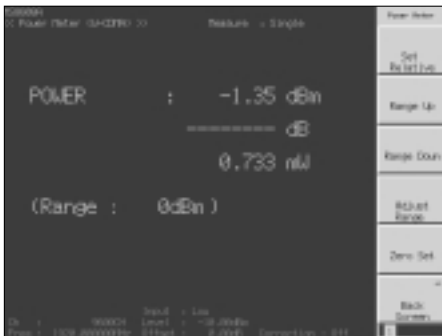

• Trellis display function

The screen displays the trellis and the modulation accuracy result simultaneously.

• Output RF spectrum measurement

The output RF spectrum measurement can be performed at high speed and simply.

• Spurious measurement

Spurious measurement has three kinds of method: Sweep, Search, and Spot. These can be selected depending on the usage.

• EDGE constellation display

The following screen represents constellation display of the 8PSK modulation through Nyquist filter and Gaussian inverse correction filter.

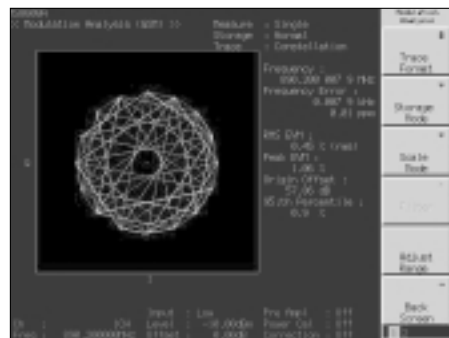

• Demodulation data monitoring

After de-spreading, up to 10 frames of I/Q data can be evaluated with external application software (Sample software can be provided).

MX860802A GSM Measurement Software

• Parameter setup

The measurement parameters such as GMSK modulation of GSM and 8PSK modulation of EDGE are set on the screen. Measurement are simply performed via a soft-key menu after setting the measurement parameters.

Specifications

• MS8608A

Frequency range	9 kHz to 7.8 GHz, 9 kHz to 7.9 GHz (with option 35)
Max. input level	High-power input: +40 dBm (10 W), Low-power input: +20 dBm (100 mW)
Input impedance	High-power input 50 Ω , VSWR: ≤ 1.2 (≤ 3 GHz)/ ≤ 1.3 (> 3 GHz) Low-power input Power meter: 50 Ω , VSWR: ≤ 1.3 (≤ 3 GHz) Except power meter: 50 Ω , VSWR: ≤ 1.5 (≤ 3 GHz)/ ≤ 2.0 (> 3 GHz) *Input attenuator: ≥ 4 dB
Input connector	N-type (high-power input), SMA-type (low-power input), BNC-type (I/Q input)
I/Q input	Input: Balanced, unbalanced Input impedance: 1M Ω (parallel capacitance: <math><100\text{ pF}</math>), 50 Ω Balanced input Differential Voltage: 0.1 to 1V(p-p), In-phase voltage ± 2.5 V Unbalanced input: 0.1 to 1V(p-p), AC/DC switchable

Continued on next page

Reference oscillator	<p>Frequency: 10 MHz Starting characteristics: $\leq 5 \times 10^{-8}$ (compared to frequency after 24 hour warm-up characteristics after 10 minute warm-up) Aging rate: $\leq 2 \times 10^{-8}$/day, $\leq 1 \times 10^{-7}$/year (compared to frequency after 24 hour warm-up) Temperature characteristics: $\leq 5 \times 10^{-8}$/day (0° to 50°C, compared to frequency at 25°C)</p>
Power meter	<p>Frequency range: 30 MHz to 3 GHz Level range: 0 to +40 dBm (high-power input), -20 to +20 dBm (low-power input) Measurement accuracy (after zero calibration): $\pm 10\%$</p>
Spectrum analyzer	<p>Frequency</p> <p>Frequency setting Setting range: 9 kHz to 3.2 GHz (Band: 0), 3.15 to 7.8 GHz (Band: 1) *Setting resolution: 1 Hz Pre-selector range: 3.15 to 7.8 GHz (Band: 1)</p> <p>Frequency accuracy Display accuracy: \pm (display frequency x reference frequency accuracy + span x span accuracy + resolution bandwidth x 0.15 + 10 Hz) Normal marker: Same as display frequency accuracy Delta marker: Same as span accuracy</p> <p>Frequency span setting range: 0 Hz, 5 kHz to 7.8 GHz Span accuracy: $\pm 1.0\%$ (at single band sweep)</p> <p>RBW (resolution bandwidth) Setting range: 300 Hz to 3 MHz (1-3 sequence), 5 MHz, 10 MHz, 20 MHz (Band 0) Accuracy: $\pm 20\%$ (300 Hz to 10 MHz) Selectivity (60 dB: 3 dB): $\leq 15:1$</p> <p>VBW (video bandwidth): 1 Hz to 3 MHz (1-3 sequence), off Sideband noise: ≤ -108 dBc/Hz (1 GHz, 10 kHz offset), ≤ -120 dBc/Hz (1 GHz, 100 kHz offset)</p>
	<p>Amplitude</p> <p>Maximum input level Continuous average power: +40 dBm (high-power input), +20 dBm (low-power input) DC voltage: 0 V</p> <p>Average noise level (at RBW: 300 Hz, VBW: 10 Hz): [Without Option 08] ≤ -104 dBm + 1.5 f [GHz] dB (high-power input, 1 MHz to 2.5 GHz, Band 0, input attenuator: 20 dB) ≤ -100 dBm + 1.5 f [GHz] dB (high-power input, 2.5 to 3.2 GHz, Band 0, input attenuator: 20 dB) ≤ -100 dBm + 0.8 f [GHz] dB (high-power input, 3.15 to 7.8 GHz, Band 1, input attenuator: 20 dB) [With Option 08] ≤ -102 dBm + 1.8 f [GHz] dB (high-power input, 1 MHz to 2.5 GHz, Band 0, input attenuator: 20 dB) ≤ -100 dBm + 1.8 f [GHz] dB (high-power input, 2.5 to 3.2 GHz, Band 0, input attenuator: 20 dB) ≤ -100 dBm + 0.8 f [GHz] dB (high-power input, 3.15 to 7.8 GHz, Band 1, input attenuator: 20 dB) [Without Option 08] ≤ -124 dBm + 1.5 f [GHz] dB (low-power input, 1 MHz to 2.5 GHz, Band 0, input attenuator: 0 dB) ≤ -120 dBm + 1.5 f [GHz] dB (low-power input, 2.5 to 3.2 GHz, Band 0, input attenuator: 0 dB) ≤ -120 dBm + 0.8 f [GHz] dB (low-power input, 3.15 to 7.8 GHz, Band 1, input attenuator: 0 dB) [With Option 08] ≤ -122 dBm + 1.8 [GHz] dB (low-power input, 1 MHz to 2.5 GHz, Band 0, input attenuator: 0 dB) ≤ -120 dBm + 1.8 f [GHz] dB (low-power input, 2.5 to 3.2 GHz, Band 0, input attenuator: 0 dB) ≤ -120 dBm + 0.8 f [GHz] dB (low-power input, 3.15 to 7.8 GHz, Band 1, input attenuator: 0 dB)</p> <p>Residual response: ≤ -80 dBm (high-power input, 1 MHz to 3.2 GHz, input attenuator: 20 dB) ≤ -70 dBm (high-power input, 3.15 to 7.8 GHz, input attenuator: 20 dB) ≤ -100 dBm (low-power input, 1 MHz to 3.2 GHz, input attenuator: 0 dB) ≤ -90 dBm (low-power input, 3.15 to 7.8 GHz, input attenuator: 0 dB)</p> <p>Reference level Setting range: -80 to +50 dBm (high-power input), -100 to +30 dBm (low-power input) Accuracy (high-power input, after calibration): ± 0.5 dB (-29.9 to +20 dBm), ± 0.75 dB (-49.9 to -30 dBm, +20.1 to +40 dBm), ± 1.5 dB (-60 to -50 dBm) Accuracy (low-power input, after calibration): ± 0.5 dB (-49.9 to +0 dBm), ± 0.75 dB (-69.9 to -50 dBm, +0.1 to +20 dBm), ± 1.5 dB (-80 to -70 dBm) *Frequency: 50 MHz, span: 1 MHz (Input attenuator, RBW, VBW and sweep time are set to AUTO.) RBW switching uncertainty: ± 0.3 dB (300 Hz to 5 MHz, referenced to RBW: 3 kHz) Input attenuator: 20 to 82 dB (high-power input), 0 to 62 dB (low-power input), 2 dB steps Frequency response: ± 0.6 dB (9 kHz to 3.2 GHz, Band 0), ± 1.0 dB (3.15 to 7.8 GHz, Band 1) *Referenced to 50 MHz, input attenuator: 30 dB (high power input)/10 dB (low power input), 18° to 28°C Log linearity: ± 0.5 dB (0 to -20 dB, RBW: ≤ 1 kHz), ± 1.0 dB (0 to -90 dB, RBW: ≤ 1 kHz)</p> <p>2nd harmonic distortion: ≤ -60 dBc (10 to 200 MHz, Band 0, mixer input: -30 dBm) ≤ -75 dBc (200 to 850 MHz, Band 0, mixer input: -30 dBm) ≤ -70 dBc (0.85 to 1.6 GHz, Band 0, mixer input: -30 dBm) ≤ -90 dBc (1.6 to 3.9 GHz, Band 1, mixer input: -10 dBm)</p> <p>Two tone 3rd order intermodulation distortion: ≤ -70 dBc (10 to 100 MHz), ≤ -85 dBc (0.1 to 7.8 GHz) *Frequency difference of two signals: ≥ 50 kHz, mixer input: -30 dBm 1 dB gain compression: ≥ 0 dBm (≥ 100 MHz), $\geq +3$ dBm (≥ 500 MHz)</p>

Continued on next page

Spectrum analyzer	Sweep	<p>Setting range: 10 ms to 1000 s (frequency axis sweep), 1 μs to 1000 s (time axis sweep) Trigger switch: Free-run, triggered Trigger source: Wide IF video, video, external (TTL level), external (± 10 V), line Trigger delay Pre-trigger range: -time span to 0 s Resolution: time span/500 or 100 ns whichever is larger. Post trigger: 0 μs to 65.5 ms, Resolution: 100 ns (sweep time: ≤ 4.9 ms), 1 μs (sweep time: ≥ 5 ms) Gate sweep mode Gate delay range: 0 to 65.5 ms (resolution: 1 μs) Gate length range: 2 μs to 65.5 ms (resolution: 1 μs)</p>
	Functions	<p>Number of data points: 501 Detection modes: Normal, Positive peak, Negative peak, Sample, Average, rms (option 04) Display functions: Trace A, Trace B, Trace A/B, Trace A/BG, Trace A/Time Storage functions: Normal, View, Max hold, Min hold, Average, Cumulative, Overwrite Markers Signal search: Auto tune, Peak \rightarrow CF, Peak \rightarrow Ref, Scroll Zone markers: Normal, Delta Marker function: Marker \rightarrow CF, Marker \rightarrow Ref, Marker \rightarrow CF step size, Δ marker \rightarrow Span, Zone \rightarrow Span Peak search: Peak, Next peak, Min dip, Next dip Multi-marker: 10 max. Measurements Noise power: dBm/Hz, dBm/ch, dBμV/\sqrtHz C/N: dBc/Hz, dBc/CH Occupied bandwidth: Power N% method, X-dB down method Adjacent channel power Reference measurement: Total power, reference level, in-band method Display methods: Channel specified display (3 channels x 2), graphic display Average power of burst signal: Average power within specified time range of time domain waveform Template comparison measurement (time sweep): Upper limit x 2, lower limit x 2 Mask measurement (frequency sweep): Upper limit x 2, lower limit x 2</p>
Others	<p>Display: Color TFT-LCD, VGA 6.5 type Hard copy: Hard copy of screen via parallel interface (ESC/P compatible printer) Memory card interface: ATA Flash card (3.3/5 V) GPIB: Can be controlled from external controller (except power switch) when specified as device Interface functions: SH1, AH1, T6, L4, SR1, RL1, PP0, DC1, DT1, C0, E2 Parallel interface: Centronics printer I/F, D-sub 25-pin connector (female) Video output: Analog RGB output, D-sub 15-pin connector (female)</p>	
Dimensions and mass	320 (W) x 177 (H) x 411 (D) mm (except handle, feet, front cover and fan cover), ≤ 16 kg (nominal)	
Power	100 to 120/200 to 240 Vac (-15%/+10%, max. voltage: 250 V, automatic voltage selection), 47.5 to 63 Hz, ≤ 400 VA	
Operating temperature and humidity	0° to 50°C, $\leq 85\%$ (no condensating)	
EMC	EN61326: 1997/A1: 1998 (Class A), EN61000-3-2: 1995/A2: 1998 (Class A), EN61326 (1997/A1: 1998 (Annex A)	
LVD	EN61010-1: 1993/A2: 1995 (Installation Category II, Pollution degree 2)	

• MX860801B W-CDMA measurement software

Guaranteed specifications after Adjust Range and Power Calibration keys pressed

Modulation/frequency measurement	<p>Frequency range: 50 MHz to 3 GHz, 50 MHz to 2.3 GHz (with option 08) Input level: -40 to +40 dBm (average power, high-power input), -60 to +20 dBm (average power, low-power input), -80 to +10 dBm (average power, low-power input, pre-amplifier: on*) Carrier frequency accuracy: \pm (reference oscillator accuracy + 10 Hz) *Input level: ≥ -10 dBm (high-power input), ≥ -30 dBm (low-power input), ≥ -40 dBm (low-power input, pre-amplifier: on*), at 1 code channel Modulation accuracy (residual EVM): <2% (rms) *Input level: ≥ -10 dBm (high-power input), ≥ -30 dBm (low-power input), ≥ -40 dBm (low-power input, pre-amplifier: on*), at 1 code channel Origin offset accuracy: ± 0.5 dB *Input level: ≥ -10 dBm (high-power input), ≥ -30 dBm (low-power input), at 1 code channel, relative to signal with origin offset of -30 dBc Waveform display (for 1 CH to multi-channel) Constellation display, EVM vs. chip, amplitude error vs. chip, phase error vs. chip</p>
Code domain analysis	<p>Frequency range: 50 MHz to 3 GHz, 50 MHz to 2.3 GHz (with option 08) Input level: -40 to +40 dBm (average power, high-power input), -60 to +20 dBm (average power, low-power input), -80 to +10 dBm (average power, low-power input, pre-amplifier: on*) Code domain power measurement accuracy: ± 0.1 dB (code power: ≥ -10 dBc), ± 0.3 dB (code power: ≥ -25 dBc) *Input level: $\geq +10$ dBm (high-power input), ≥ -10 dBm (low-power input), ≥ -20 dBm (pre-amplifier: on*) Code domain error measurement Residual error: <-50 dB, Measurement accuracy: ± 0.5 dB (at error of -30 dBc) *Input level: $\geq +10$ dBm (high-power input), ≥ -10 dBm (low-power input), ≥ -20 dBm (pre-amplifier: on*), spread factor: 512 (down-link)/256 (up-link) Display function: Code domain power, code domain error Spread factor: 4 to 256 (up-link)/4 to 512 (down-link), I/Q separately displayed at up-link</p>

Continued on next page

<p>Amplitude measurement</p>	<p>Frequency range: 50 MHz to 3 GHz, 50 MHz to 2.3 GHz (with option 08) Input level: -40 to +40 dBm (average power, high-power input), -60 to +20 dBm (average power, low-power input), -80 to +10 dBm (average power, low-power input, pre-amplifier: on*1) Transmitter power measurement Measurement range: 0 to +40 dBm (average power, high-power input), -20 to +20 dBm (average power, low-power input), -20 to +10 dBm (average power, low-power input, pre-amplifier: on*1) Accuracy: ±0.4 dB (calibrated at internal power meter) Power measurement linearity: ±0.2 dB (0 to -40 dB) *Input level: ≥+10 dBm (high-power input), ≥-10 dBm (low-power input), ≥-20 dBm (pre-amplifier: on*1), after the range adjusted, with the reference level setting unchanged Filter selection function: Power measurement through RRC (α = 0.22) filter Transmitter power control measurement function: Relative power per slot, NO/GO evaluation</p>
<p>Occupied bandwidth measurement</p>	<p>Frequency range: 50 MHz to 3 GHz Input level: -40 to +40 dBm (average power, high-power input), -60 to +20 dBm (average power, low-power input), -80 to +10 dBm (average power, low-power input, pre-amplifier: on*1) Sweep mode: Displays result after signal measured with sweep spectrum analyzer FFT mode: Displays result after FFT</p>
<p>Adjacent channel power measurement</p>	<p>Frequency range: 50 MHz to 3 GHz, 50 MHz to 2.3 GHz (with option 08) Input level: +10 to +40 dBm (average power, high-power input), -10 to +20 dBm (average power, low-power input) Sweep method (all): Calculates and displays result after signal measured with sweep spectrum analyzer Sweep method (separate): Calculates and displays power after each adjacent channel measured with sweep spectrum analyzer Filter method: Measures and displays power of adjacent channels after passing via built-in receiving filters (RRC: α = 0.22) Measurement range Input level: +20 to +40 dBm (high-power input), 0 to +20 dBm (low-power input) ≥55 dBc (5 MHz offset), ≥62 dBc (10 MHz offset) *Filter method, wide dynamic range mode, 1 code channel ≥50 dBc (5 MHz offset), ≥60 dBc (10 MHz offset) *At 16 multi-code channel Input level: +10 to +40 dBm (high-power input), -10 to +20 dBm (low-power input) 55 dBc (5 MHz offset), 62 dBc (10 MHz offset) *Filter method, wide dynamic range mode, 1 code channel (typical) 50 dBc (5 MHz offset), 60 dBc (10 MHz offset) *At 16 multi-code channel (typical)</p>
<p>Spurious measurement</p>	<p>Measurement frequency: 9 kHz to 7.8 GHz (except within carrier frequency ±50 MHz) Input level (transmitter power): +20 to +40 dBm (average power, high-power input), 0 to +20 dBm (average power, low-power input) Measurement method [Sweep method] Sweeps the specified range of frequency using the spectrum analyzer, and then detects and displays the peak value. Calculates the rate for transmission power value and displays it as power rate. Waveform detection mode: average [Spot method] Measures the specified frequency with time domain from the spectrum analyzer and then displays the average value. Calculates the rate for transmission power value and displays it as power rate. Waveform detection mode: average [Search method] Sweeps the specified frequency range using the spectrum analyzer to detect the peak value, then measures the frequency using the time domain to display the average value. Calculates the rate for transmission power value and displays it as power rate. Waveform detection mode: average Measurement range*2 [Carrier frequency: 1.8 to 2.2 GHz] ≥79 dB (RBW: 1 kHz, 9 to 150 kHz, Band 0), ≥79 dB (RBW: 10 kHz, 150 kHz to 30 MHz, Band 0), ≥79 dB (RBW: 100 kHz, 30 to 1000 MHz, Band 0) [Normal mode] ≥76 -f [GHz] dB (RBW: 1 MHz, 1 to 3.15 GHz, Band 0), ≥76 dB (RBW: 1 MHz, 3.15 to 7.8 GHz, Band 1) [Spurious mode (with option 03)] ≥76 dB (RBW: 1 MHz, 1.6 to 7.8 GHz, Band 1)</p>
<p>I/Q signal</p>	<p>Input: Balanced, unbalanced Input impedance: 1 MΩ (parallel capacity: <100 pF), 50 Ω Balanced input Differential voltage: 0.1 to 1 V (p-p), In-phase voltage: ±2.5 V Unbalanced input: 0.1 to 1 V (p-p), AC/DC switchable Measurement items: Modulation accuracy, code domain power, amplitude, occupied bandwidth (FFT method), I/Q level Residual vector error: <2% (rms) *Input level: ≥0.1 V (rms), DC coupling I/Q level measurement: Measures and displays each I, Q input voltage (rms, p-p) I/Q phase difference measurement: When the CW signal is inputted to I and Q input terminals, measures and displays the phase difference between I- and Q-phase signals.</p>

*1: Can be set when MS8608A-08 option is installed in the main frame.

*2: When carrier frequency is in a 2030.354 to 2200 MHz range, spurious will be generated at the frequency below.
 f (spurious) = f (input) - 2030.345 MHz

• **MX860802A GSM measurement software**

Guaranteed specifications after Adjust Range and Power Calibration keys pressed

<p>Modulation/frequency measurement</p>	<p>Frequency range: 50 MHz to 2.7 GHz Input level: -20 to +40 dBm (average power within burst, high-power input) -40 to +20 dBm (average power within burst, low-power input) -60 to +10 dBm (average power within burst, low-power input, pre-amplifier: on*1) Carrier frequency accuracy: ±(reference oscillator accuracy + 10 Hz) *Input level (average power within burst: ≥-10 dBm (high-power input): ≥-30 dBm (low-power input), ≥-40 dBm (low-power input, pre-amplifier: on*1) Residual phase error (GMSK modulation): <0.5° (rms), <2.0° (peak) *Input level (average power within burst): ≥-10 dBm (high-power input), ≥-30 dBm (low-power input), ≥-40 dBm (low-power input, pre-amplifier: on*1) Residual EVM (8PSK modulation): <1% (rms) Waveform display: Trellis (GMSK modulation), eye pattern, EVM vs. bit (8PSK modulation), phase vs. bit, amplitude vs. symbol, I/Q diagram</p>
<p>Amplitude measurement</p>	<p>Frequency range: 50 MHz to 2.7 GHz Input level: -20 to +40 dBm (average power within burst, high-power input) -40 to +20 dBm (average power within burst, low-power input) -60 to +10 dBm (average power within burst, low-power input, pre-amplifier: on*1) Transmitter power measurement (auto calibrated at internal power meter) Measurement range: +10 to +40 dBm (average power within burst, high-power input) -10 to +20 dBm (average power within burst, low-power input) -10 to +10 dBm (average power within burst, low-power input, pre-amplifier: on*1) Accuracy: ±0.4 dB Power measurement linearity: ±0.2 dB (0 to -30 dBm) *Input level (average power within burst): +10 dBm (high-power input), ≥-10 dBm (low-power input), ≥-20 dBm (low-power input, pre-amplifier: on*1), without changing the reference level setting after range optimization Carrier-off power measurement range [Input level (average power within burst)] +10 dBm (high-power input), ≥-10 dBm (low-power input), ≥-20 dBm (low-power input, pre-amplifier: on*1) [Normal mode] ≥60 dB (compared with average power within burst) [Wide dynamic range mode] ≥80 dB (high-power input: 1 W, compared with 10 mW of average power within burst, low-power input) *Measurement limit is decided by average noise level (≤50 dBm, 50 MHz to 2.7 GHz). Rise/fall characteristics: Display rising/falling edges while synchronizing to modulation data of signal data to be measured. Standard line display possible (measured by 1 MHz bandwidth). NO/GO judgement function</p>
<p>Output RF spectrum measurement</p>	<p>Frequency range: 100 MHz to 2.7 GHz Input level: +10 to +40 dBm (average power within burst, high-power input) -10 to +20 dBm (average power within burst, low-power input) -20 to +10 dBm (average power within burst, low-power input, pre-amplifier: on*1) Modulation portion measurement range: ≥60 dB (≥200 kHz offset), ≥68 dB (≥250 kHz offset) *CW signal, RBW: 30 kHz (<1.8 MHz offset), RBW: 100 kHz (≥1.8 MHz offset) Transient portion measurement range: ≥63 dB (CW, ≥400 kHz offset)</p>
<p>Spurious measurement</p>	<p>Measurement frequency: 100 kHz to 7.8 GHz (except within carrier frequency ±50 MHz) Input level (transmitter power): +20 to +40 dBm (average power within burst, high-power input) 0 to +20 dBm (average power within burst, low-power input) Measurement method [Sweep method] Sweeps the specified range of frequency using the spectrum analyzer, and then detects and displays the peak value. Calculates the rate for transmission power value and displays it as power rate. Waveform detection mode: average [Spot method] Measures the specified frequency with time domain from the spectrum analyzer and then displays the average value. Calculates the rate for transmission power value and displays it as power rate. Waveform detection mode: average [Search method] Sweeps the specified frequency range using the spectrum analyzer to detect the peak value, then measures the frequency using the time domain to display the average value. Calculates the rate for transmission power value and displays it as power rate. Waveform detection mode: average Measurement range [Carrier frequency: 0.8 to 1 GHz, 1.8 to 2 GHz] ≥72 dB (RBW: 10 kHz, 100 kHz to 50 MHz, Band 0), ≥72 dB (RBW: 100 kHz, 50 to 500 MHz, Band 0) [Normal mode] ≥66 -f [GHz] dB (RBW: 3 MHz, 0.5 to 3.15 GHz, Band 0, except harmonic frequency) ≥66 dB (RBW: 3 MHz, 3.15 to 7.8 GHz, Band 1) [Spurious mode (with option 03)] ≥66 dB (RBW: 3 MHz, 1.6 to 7.8 GHz, Band 1)</p>

Continued on next page

I/Q signal	Input: Balanced, unbalanced Input impedance: 1 MΩ (parallel capacity: <100 pF), 50 Ω Balanced input Differential voltage: 0.1 to 1 V (p-p), In-phase voltage: ±2.5 V Unbalanced input: 0.1 to 1 V (p-p), AC/DC switchable Measurement items: Modulation accuracy, I/Q level Modulation accuracy Residual phase error: <0.5° (rms), DC coupling Residual EVM: <1.0% (rms), DC coupling *Input level: ≥0.1 V (rms), 18° to 28°C I/Q level measurement: Measures and displays each I, Q input voltage (rms, p-p) I/Q phase difference measurement: When the CW signal is inputted to I and Q input terminals, measures and displays the phase difference between I- and Q-phase signals.
------------	---

*1: Can be set when MS8608A-08 option is installed in the main frame.

Ordering information

Please specify model/order number, name and quantity when ordering.

Model/Order No.	Name
MS8608A	Main frame Digital Mobile Radio Transmitter Tester
	Standard accessories
	Power cord, 2.6 m: 1 pc
J0996B	RS-232C cable: 1 pc
JT32MA3-NT1	PC-ATA card (32 MB): 1 pc
F0014	Fuse, 6.3 A: 1 pc
J0576B	Coaxial cord (N-P · 5D-2W · N-P), 1 m: 1 pc
MX268001A	File transfer utility: 1 pc
W1709AE	MS8608A/8609A operation manual (Vol. 1): 1 copy
W1744AE	MS8608A/8609A operation manual (Vol. 2): 1 copy
W1745AE	MS8608A/8609A operation manual (Vol. 3): 1 copy
	Options
MS8608A-01	Precision frequency reference (aging rate: 5 x 10 ⁻¹⁰ /day)
MS8608A-03	Extension of pre-selector lower limit (to 1.6 GHz)
MS8608A-04	Digital resolution bandwidth
MS8608A-05	Rubidium reference oscillator
MS8608A-08	Pre-amplifier (100 kHz to 3 GHz)
MS8608A-09	Ethernet interface
MS8608A-35	7.9 GHz frequency extension
MS8608A-46	Auto-power recovery
MS8608A-47	Rack mount without handle (IEC)
MS8608A-48	Rack mount without handle (JIS)
	Measurement software
MX860801B	W-CDMA Measurement Software
MX860802A	GSM Measurement Software
W1746AE	MX860801B/860901B operation manual
W1795AE	MX860802A/860902A operation manual
	Optional accessories
J0576D	Coaxial cord (N-P · 5D-2W · N-P), 2 m
J0127C	Coaxial cord (BNC-P · RG-58A/U · BNC-P), 0.5 m
J0127A	Coaxial cord (BNC-P · RG-58A/U · BNC-P), 1 m
MA1612A	Four-Way Junction Pad (5 to 3000 MHz)
J0395	High-power fixed attenuator (30 dB, 30 W, DC to 8 GHz)
B0472	High-power fixed attenuator (30 dB, 100 W, DC to 18 GHz)
J0007	GPIB cable, 1 m
J0008	GPIB cable, 2 m
B0452A	Hard carrying case (with casters)
B0452B	Hard carrying case (without casters)
B0329G	Front cover (3/4MW4U)
B0488	Rear panel protective pad
	Maintenance service
MS8608A-90	Extension service 3 years
MS8608A-91	Extension service 5 years

DIGITAL MOBILE RADIO TRANSMITTER TESTER

MS8604A

100 Hz to 8.5 GHz

For Mobile Communications Systems Worldwide

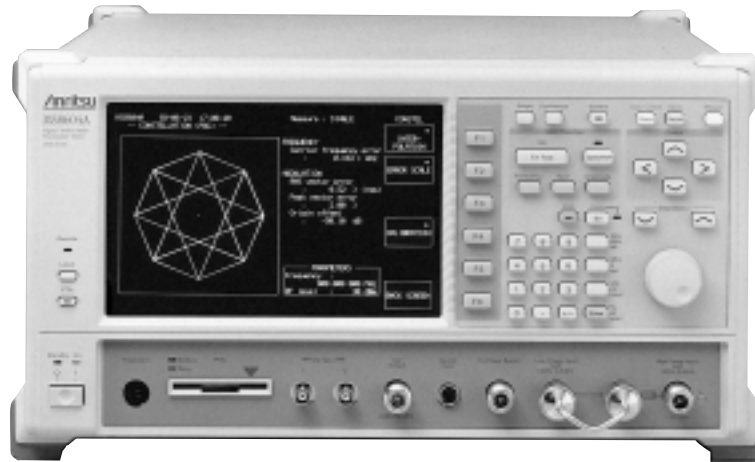

PTA GPIB

The MS8604A offers full test performance in a single unit capable of evaluating the major characteristics of transmitters used in digital mobile communication worldwide. Applicable systems are PDC, PHS, NADC, digital MCA, GSM, DCS1800 (PCN), CT2, DECT, WCPE, PACS, RCR STD-39 and TETRA. In addition, the MS8604A has GMSK and $\pi/4$ DQPSK universal analysis functions for analysis of the GMSK and $\pi/4$ DQPSK modulation signal. It covers frequencies from 100 Hz to 8.5 GHz and measures spurious emissions over a broad frequency range. It can also measure RF signals directly up to 10 W (average burst power), and baseband devices can be evaluated using its I/Q signal input function (option). The MS8604A is ideal for high-speed measurement of carrier frequency, modulation accuracy, antenna power, leakage power during carrier-off, transmission ramp-up and ramp-down power, and occupied bandwidth (adjacent channel power, spurious emissions, and signal transmission rate)* of digital mobile transmitters. In addition to measurements conforming to EIA/TIA, ETSI, RCR, and MKK standards, DSP (digital signal processing) and high-speed measurement functions based on a unique measurement algorithm combine to greatly reduce the time required for manufacturing and inspecting transmitters. PTA functions enabling free programming of test procedures are provided as a standard feature.

*: Measurement items depend on the measurement software. For details, refer to the specifications.

Features

- Major transmitter functions evaluated by a single system
- Compatible with NADC, PDC, PHS, Digital MCA, GSM, DCS1800 (PCN), CT2, DECT, WCPE, PACS, RCR STD-39 TETRA systems, and GMSK and $\pi/4$ DQPSK universal measurement (measurement software can be installed as an option)
- High-speed measurement (under 1 second for modulation-accuracy measurements)
- Input up to 10 W (internal 20 dB attenuator and power meter for high power levels)

Measurement example

• Quick configuration for different communication systems

Optional measurement software can be installed in the MS8604A. When these options are chosen, the communication system can be selected by pressing a single key.

• One-touch selection of measurement items

Measurement items can be selected by pressing a single key. The input connector (RF/IQ), maximum input power, and type of signal for measurement (uplink/downlink, channel number/frequency, frequency

steps, synchronizing words) can be preset. In particular, synchronizing words can be predefined to any value. Measurement can be performed in either the single-measurement mode (one measurement performed each time key pressed) or in the automatic continuous repeat mode.



• Measurement of frequency, modulation accuracy

Frequency and modulation accuracy (vector error, phase error) can be measured. The numerical display and modulation waveform (constellation etc.) are displayed simultaneously, providing an accurate visual representation of the modulation waveform.

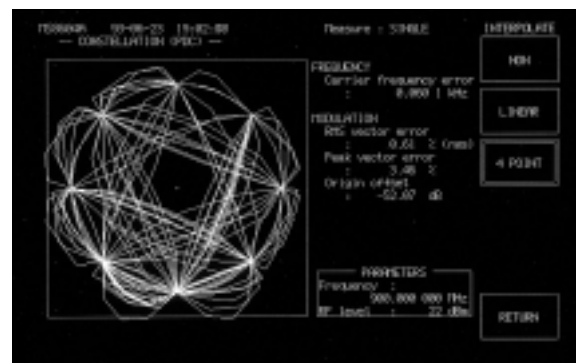

• **Direct measurement with broadband power sensor**

The tester has a high-performance power meter comparable to the Anritsu ML4803A. A broadband amorphous-element power sensor is coupled directly for high-precision measurement.

• **Internal calibration signal**

An internal 1 mW calibration signal is provided for calibrating the sensitivity of the power sensor automatically by pressing the CAL ADJUST key.

• **High-power measurements**

Antenna power up to 10 W max (burst average power) can be measured directly using the internal high-power attenuator. This high-power attenuator is pre-calibrated for accurate measurement of transmitter power levels.

• **Measurement of antenna power and leakage power during carrier-off**

At measurement of burst signal antenna power, the power-on intervals are auto-detected based on the modulated wave, so an external synchronization trigger is not needed. In addition, the average power during power-on intervals is automatically matched to a template value, simplifying measurement automation. Any template can be set, and three types can be stored. The leakage power during carrier-off can be measured as either an absolute value or as an on/off ratio. When the carrier-off power is low, measurements can be performed in a wide-dynamic-range mode (during single-mode measurements with synchronizing word).

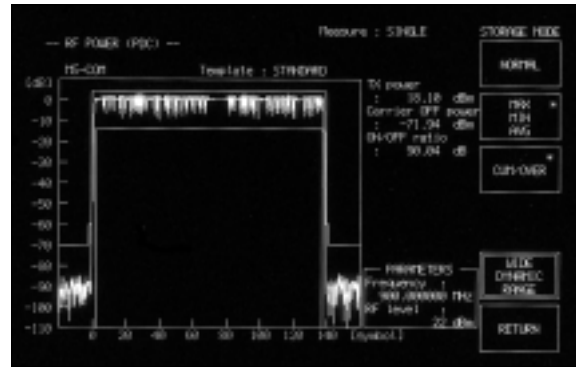

Wide dynamic range mode (PDC)

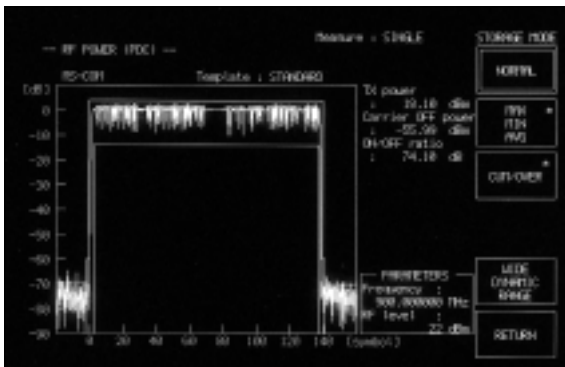

Normal mode (PDC)

• **Application software**

The application software extends the analysis function of the MS8604A by using PTA (Personal Test Automation) functions. The application software provides sophisticated analysis of digital modulation signals. The MX3512A uses $\pi/4$ DQPSK analysis software. The MX3513A uses M16QAM analysis software. The MX3518A/3519A/3520A are adjacent channel power and spurious measurement software for GSM, DCS1800 (PCM), DECT, and CT2 systems.

Applicable system	Measurement software	Application software (supplied by PMC)
PDC	Option 11	MX3512A
PHS	Option 12	
NADC	Option 13	
Digital MCA	Option 14	MX3513A
GSM	Option 15	MX3518A
DCS1800 (PCN)		MX3519A
DECT		MX3520A
CT2		—
General-purpose GMSK	Option 16	—
WCPE		—
RCR STD-39		
PACS		
TETRA		
General-purpose $\pi/4$ DQPSK		

Specifications

• **MS8604A**

General	Frequency range	100 Hz to 8.5 GHz
	Max. input level (continuous wave average power)	+40 dBm (10 W)
Spectrum analyzer	Reference oscillator	Frequency: 10 MHz Starting characteristics: $\leq 5 \times 10^{-8}$ /day (option: $\leq 2 \times 10^{-8}$ /day after 30 min. warm-up) *After 10 min. of warm-up, compared to the frequency after 24-hour warm-up Aging rate: $\leq 2 \times 10^{-8}$ /day (option: $\leq 5 \times 10^{-9}$ /day), $\leq 1 \times 10^{-7}$ /year (option: $\leq 5 \times 10^{-8}$ /year) *Compared to the frequency after 24-hour warm-up Temperature characteristics: 5×10^{-8} (option: 3×10^{-8}) *0° to 50°C, relative to the frequency at 25°C
	Frequency	Setting range: 100 Hz to 8.5 GHz (resolution: 1 Hz), 0 to 2 GHz (freq. band: 0), 1.7 to 7.5 GHz (freq. band: 1-), 6.5 to 8.5 GHz (freq. band: 1+) Preselector range: 1.7 to 8.5 GHz (bands: 1-/1+) Display accuracy: \pm (display freq. x reference freq. accuracy + span x span accuracy) Span Setting range: 0 Hz, 100 Hz to 8.5 GHz Accuracy: $\pm 2.5\%$ (span ≥ 1 kHz), $\pm 5\%$ (100 Hz \leq span < 1 kHz) RBW Setting range: 10 Hz to 3 MHz (3 dB), 1-3 sequence Accuracy: $\pm 20\%$ Selectivity (60/3 dB): $\leq 15:1$ (100 kHz to 3 MHz), $\leq 12:1$ (10 Hz to 30 kHz) VBW: 1 Hz to 3 MHz, off, 1-3 sequence Signal purity (SSB, 1 MHz to 4 GHz): ≤ -100 dBc/Hz (10 kHz offset), ≤ -115 dBc/Hz (50 kHz offset), ≤ -120 dBc/Hz (100 kHz offset)

Continued on next page

Spectrum analyzer	Amplitude	Level measurement	Level measuring range: Average noise level to +40 dBm Average noise level: ≤ -112 dBm (10 MHz to 8.5 GHz, RBW 10 Hz, VBW 1 Hz, input att. setting 20 dB) Residual response: ≤ -75 dBm (1 MHz to 8.5 GHz, input att. setting 20 dB)
		Reference level	Setting range: -80 to $+40$ dBm Accuracy: ± 0.5 dB (-30 to $+20$ dBm), ± 0.75 dB (-40 to -30 dBm, $+20$ to $+40$ dBm), ± 1.5 dB (-60 to -40 dBm) *After calibration and at freq. 100 MHz, span ≤ 2 MHz, and in auto mode for input att., RBW, VBW and sweep time settings RBW switching error (after calibration): ± 0.3 dB (RBW: ≤ 300 kHz), ± 0.7 dB (RBW: ≥ 1 MHz) LOG/LIN switching error: ± 0.3 dB (after calibration) Input attenuator Setting range: 20 to 75 dB in 5 dB steps Switching error: ± 0.3 dB (referred to input att. 30 dB, at 100 MHz)
		Frequency response	± 0.5 dB (100 MHz to 2 GHz, band: 0), ± 1 dB (1.7 to 8.5 GHz, bands: 1-/-1+) *Referred to at 100 MHz, input att. 30 dB, temperature 18° to 28°C (after tuning preselector at bands 1-/-1+)
		Linearity (after calibration)	LOG: ± 0.3 dB (0 to -20 dB, RBW: ≤ 1 MHz), ± 1 dB (0 to -60 dB, RBW: ≤ 100 kHz), ± 1.5 dB (0 to -80 dB, RBW: ≤ 10 kHz) LIN: $\pm 5\%$ (to reference level)
		Dynamic range	2nd harmonics: ≤ -70 dBc (5 to 800 MHz, band: 0, mixer input level: -30 dBm), ≤ -80 dBc (800 to 850 MHz, band: 0, mixer input level: -30 dBm), ≤ -90 dBc (850 MHz to 2.1 GHz, bands: 1-, mixer input level: -10 dBm) Two-signal third-order intermodulation distortion: ≤ -70 dBc (10 to 50 MHz), ≤ -85 dBc (50 MHz to 2.1 GHz) *Frequency difference between two signals ≥ 50 kHz, mixer input level: -30 dBm
		Spurious	Image response: ≤ -70 dBc Multiple-response: ≤ -70 dBc (bands: 1-/-1+)
		Sweep	Sweep time Setting range: 20 ms to 1000 s (TRACE-FREQ., data points: NORMAL), 50 ms to 1000 s at other conditions Accuracy: $\pm 10\%$ (20 ms to 200 s), $\pm 15\%$ (200 to 1000 s) Sweep mode: CONTINUOUS, SINGLE Trigger: FREE RUN, TRIGGERED Trigger source: VIDEO, LINE, EXT (± 10 V), EXT (TTL) Gate mode (OFF, random sweep mode) GATE DELAY: 0 to 65.5 ms (in 1 μ s steps) GATE LENGTH: 20 μ s to 65.5 ms (in 1 μ s steps, GATE END: INT) GATE END: INT/EXT
		Time domain waveform display	Sweep time: 50, 100 to 900 μ s (data point: NORMAL, One most significant digit can be set.) 1 ms to 1000 s (data point: NORMAL, Two most significant digits can be set.) 100, 200 to 800 μ s (data point: DOUBLE, One most significant digit can be set as even number.) 1 ms to 1000 s (data point: DOUBLE, Two most significant digits can be set as even number.) Delay time Pre-trigger: $-$ time span to 0 s (in 1 point steps) Post trigger: 0 to 65.5 ms (in 1 μ s steps) Amplitude display resolution: 50 μ s to 49 ms, 10 bits (0.1% of full scale) 50 ms to 1000 s, 14 bits (0.01% of full scale)
		Detection mode	POS PEAK, SAMPLE, NEG PEAK
		Number of points	NORMAL: 501 points, DOUBLE: 1002 points
		AM/FM demodulation	Demodulated waveform display and monitoring demodulated audio signal with internal speaker
		Power meter	Auxiliary inputs/ outputs
Frequency range	100 kHz to 5.5 GHz		
Level range	-20 to $+20$ dBm		
Instrumentation accuracy	$\pm 0.5\%$		
Zero set	$\pm 0.5\%$ of full scale at most sensitive range (100 μ W range)		
Zero shift between ranges	$\pm 0.2\%$ of full scale zero setting at most sensitive range		
Calibration oscillator	Freq: 50 MHz, Output: 1.00 mW, Accuracy: $\pm 1.2\%$		
Applicable power sensor	MA4601A		

Continued on next page

Others	Display	640 x 400 dot, 9-inch EL	
	Inputs/outputs on rear panel	Reference input: 10 MHz \pm 10 Hz, 2 to 5 Vp-p, \geq 50 Ω , BNC connector Reference buffer output: 10 MHz, 2 to 3 Vp-p (with the output terminated by 200 Ω terminator), BNC connector Separate video output: Compatible with 8-pin DIN connector	
	External memory	One slot for can be connected.	
	Save/recall	Internal memory (4 sets of spectrum and Tx test conditions), can save/recall setting conditions at external memory (PMC)	
	Direct plotting	Can hard-copy screen via GPIB 2	
	External control	GPIB 1 (IEEE 488.2)	As device controlled by host, all functions except power switch Controls other instruments as controller using PTA SH1, AH1, T6, L4, SR1, RL1, PP0, DC1, DT1, C0 (C1, C2, C3 and C24 with PTA)
		GPIB 2 (IEEE 488.1)	Controls other instruments as controller SH1, AH1, T6, L4, SR0, RL0, PP0, DC0, DT0, C1, C2, C3, C4, C28
		I/O port	Output port A/B: 8-bit (TTL level), Input/Output port C/D: 4-bit (TTL level), Exclusive port: 3-bit (TTL level) Control signal: 4 (TTL level), +5 V output: Max. 50 mA
		RS-232C (Option 02)	Controls other instruments as controller
	PTA	Language	PTL: High level language interpreter based on BASIC
Programming		Using external keyboard	
Program memory		On PMC or FD Upload/download from/to PC	
Programming capacity		900 KB	
Operating temperature	0° to 50°C		
Power	85 to 132/170 to 250 Vac, 47.5 to 63 Hz, \leq 500 VA		
Dimensions and mass	426 (W) x 221.5 (H) x 451 (D) mm, \leq 27 kg		

• **Option 11: Measurement software (for PDC)**

The following specifications are guaranteed if the internal level is optimized using the auto range of the MS8604A calibration function.

Modulation/ frequency measurement	Frequency range	400 kHz to 2.1 GHz
	Input level	-10 to +40 dBm (average power of burst signal) *When using the low power input connector, measurement to levels 20 dB lower than the above values is possible.
	Frequency accuracy	\pm (accuracy of reference oscillator +1 Hz)
	Modulation accuracy	\pm (2% of indicated value +0.5%)
	Origin offset accuracy	\pm 0.5 dB to signal level of -30 dBc
	Transmission rate accuracy	\pm 1 ppm
	Measuring range of transmission rate	42 kbps \pm 100 ppm
	Waveform display	Constellation display
Measurement time	\leq 1 s(except transmission rate measurement), \leq 3 s(transmission rate measurement)	
Amplitude measurement	Frequency range	10 MHz to 2.1 GHz
	Input level range	+10 to +40 dBm (average power of burst signal)
	Transmission power accuracy	\pm 10% (using high power input after calibration with MA4601A Power Sensor)
	Carrier-off power	Measurement range in Normal mode: \geq 65 dB (to average power of burst signal) Average noise level in Wide dynamic range mode: \leq -60 dBm (100 MHz \leq frequency \leq 2.1 GHz) *Measurement range is \geq 95 dB for 3 W input level of average power of burst signal.
	Rise/fall edge characteristic	Display rising/falling edges while synchronizing with modulation characteristics data of measured signal
	Measurement time	\leq 1 s
	Impedance	50 Ω (VSWR: \leq 1.2)
Occupied bandwidth measurement	Frequency range	10 MHz to 2.1 GHz
	Input level range	+10 to +40 dBm (average power of burst signal)
	Standard mode (spectrum analyzer mode)	Measurement: Displays results of occupied bandwidth measurement after measuring signal with spectrum analyzer Measurement time: Approx. 12 s in full rate when number of data points set to Normal
	High-speed mode	Measurement: Displays results of occupied bandwidth measurement after FFT of measured signal Measurement time: \leq 1 s

Continued on next page

Adjacent channel power	Frequency range	100 MHz to 2.1 GHz
	Input level range	+10 to +40 dBm (average power of burst signal)
	Measurement	Standard mode: Displays results of leakage power of adjacent channel measurement after measuring signal with spectrum analyzer; measurement time: approx. 13 s when number of data points set to Normal-All High-speed mode: Displays results of leakage power of adjacent channel measured after passing signal through internal root-Nyquist filter; measurement time: ≤ 1.5 s
	Measurement range	Standard mode: ≥ 60 dB (50 kHz offset), ≥ 65 dB (100 kHz offset) High-speed mode: ≥ 60 dB (50 kHz offset), ≥ 65 dB (100 kHz offset) *Ratio of average power of burst signal to average value of leakage power of adjacent channel at burst-on time
Spurious measurement	Frequency range	10 MHz to 8.5 GHz (except frequency range ± 1 MHz of carrier frequency)
	Input level range (transmission power)	+10 to +40 dBm (average power of burst signal)
	Measurement range	≥ 65 dB (10 MHz to 1.7 GHz), ≥ 75 dB (1.7 to 8.5 GHz) *At carrier frequency range 800 MHz to 1.7 GHz
I/Q input (Option 03)		Input level range: 0.3 to 1.5 Vp-p Input impedance: 5 k Ω , AC/DC coupling (switchable) Measurement items: Modulation, amplitude, occupied bandwidth

• Option 12: Measurement software (for PHS)

The following specifications are guaranteed if the internal level is optimized using the auto range of the MS8604A calibration function.

Modulation/ frequency measurement	Frequency range	10 MHz to 2.1 GHz
	Input level	-10 to +40 dBm (average power of burst signal) *When using the low power input connector, measurement to levels 20 dB lower than the above values is possible.
	Frequency accuracy	\pm (accuracy of reference oscillator +10 Hz)
	Modulation accuracy	\pm (2% of indicated value +0.7%)
	Origin offset accuracy	± 0.5 dB to signal level of -30 dBc
	Transmission rate accuracy	± 1 ppm
	Measuring range of transmission rate	384 kbps ± 100 ppm
	Waveform display	Constellation display
	Measurement time	≤ 1 s (except transmission rate measurement), ≤ 2 s (transmission rate measurement)
Amplitude measurement	Frequency range	10 MHz to 2.1 GHz
	Input level range	+10 to +40 dBm (average power of burst signal)
	Transmission power accuracy	$\pm 10\%$ (using high power input after calibration with MA4601A Power Sensor)
	Carrier-off power	Measurement range in Normal mode: ≥ 55 dB (to average power of burst signal) Average noise level in Wide dynamic range mode: ≤ -50 dBm (100 MHz \leq frequency ≤ 2.1 GHz) *Measurement range is ≥ 69 dB for 80 mW input level of average power of burst signal.
	Rise/fall edge characteristics	Display rising/falling edges while synchronizing with modulation data of measured signal
	Measurement time	≤ 1 s
Occupied bandwidth measurement	Frequency range	10 MHz to 2.1 GHz
	Input level range	+10 to +40 dBm (average power of burst signal)
	Standard mode (spectrum analyzer mode)	Measurement: Displays results of occupied bandwidth measurement after measuring signal with spectrum analyzer Measurement time: Approx. 4 s when number of data points of spectrum analyzer set to Normal
	High-speed mode	Measurement: Displays results of occupied bandwidth measurement after FFT of measured signal Measurement time: ≤ 1 s
Adjacent channel power	Frequency range	100 MHz to 2.1 GHz
	Input level range	+10 to +40 dBm (average power of burst signal)
	Measurement	Standard mode: Displays results of leakage power of adjacent channel measurement after measuring signal with spectrum analyzer; measurement time: approx. 5 s when number of data points set to Normal-All High-speed mode: Displays results of leakage power of adjacent channel measured after passing signal through internal root-Nyquist filter; measurement time: ≤ 1.5 s
	Measurement range	Standard mode: ≥ 60 dB (600 kHz offset), ≥ 60 dB (900 kHz offset) High-speed mode: ≥ 60 dB (600 kHz offset), ≥ 60 dB (900 kHz offset) *Ratio of average power of burst signal to average value of leakage power of adjacent channel at burst-on time
Spurious measurement	Frequency range	10 MHz to 8.5 GHz (except frequency range ± 50 MHz of carrier frequency)
	Input level range (transmission power)	+10 to +40 dBm (average power of burst signal)
	Measurement range	≥ 60 dB (10 MHz to 1.7 GHz), ≥ 70 dB (1.7 to 8.5 GHz) *At carrier frequency range 800 MHz to 2 GHz
I/Q input (Option 03)		Input level range: 0.3 to 1.5 Vp-p Input impedance: 5 k Ω , AC/DC coupling (switchable) Measurement items: Modulation, amplitude, occupied bandwidth

• **Option 13: Measurement software (for NADC)**

The following specifications are guaranteed optimizing the internal level using the auto range of the MS8604A calibration function.

Modulation/ frequency measurement	Frequency range	400 kHz to 2.1 GHz
	Input level	-10 to +40 dBm (burst average power) *When using the low power-input connector, measurement to levels 20 dB lower than the above values is possible.
	Frequency accuracy	± (accuracy of reference oscillator +1 Hz)
	Modulation accuracy	± (2% of indicated value +0.5%)
	Origin offset accuracy	±0.5 dB to signal level of -30 dBc
	Transmission rate accuracy	±1 ppm
	Measuring range of transmission rate	48.6 kbps ±100 ppm
	Waveform display	Constellation display
Measurement time	≤1 s (except transmission rate measurement), ≤3 s (transmission rate measurement)	
Amplitude measurement	Frequency range	10 MHz to 2.1 GHz
	Input level range	+10 to +40 dBm (average power of burst signal)
	Transmission power accuracy	±10% (using high-power input after calibration with MA4601A Power Sensor)
	Carrier-off power	Measurement range in Normal mode: ≥65 dB (to average power of burst signal) Average noise level in Wide dynamic range mode: ≤-60 dBm (100 MHz ≤frequency ≤2.1 GHz) *Measurement range is ≥96 dB for +36 dBm input level of average power of burst signal.
	Rise/fall edge characteristics	Display rising/falling edges while synchronizing with modulation data of measured signal
	Measurement time	≤1 s
Occupied bandwidth measurement	Impedance	50 Ω (VSWR: ≤1.2)
	Frequency range	10 MHz to 2.1 GHz
	Input level range	+10 to +40 dBm (average power of burst signal)
	Standard mode (spectrum analyzer mode)	Measurement: Displays results of occupied bandwidth measurement after measuring signal with spectrum analyzer Measurement time: Approx. 12 s in full rate when number of data points set to Normal
Adjacent channel power	High-speed mode	Measurement: Displays results of occupied bandwidth measurement after FFT of measured signal Measurement time: ≤1 s
	Frequency range	100 MHz to 2.1 GHz
	Input level range	+10 to +40 dBm (average power of burst signal)
	Measurement	Standard mode: Displays results of leakage power of adjacent channel measurement after measuring signal with spectrum analyzer; measurement time: approx. 13 s when number of data points set to Normal-All High-speed mode: Displays results of leakage power of adjacent channel measured after passing signal through internal root-Nyquist filter; measurement time: ≤2 s
Spurious measurement	Measurement range	High-speed mode: ≥30 dB (30 kHz offset), ≥60 dB (60 kHz offset), ≥65 dB (90 kHz offset) *Ratio of average power of burst signal to average value of leakage power of adjacent channel at burst-on time
	Frequency range	10 MHz to 8.5 GHz (except frequency range ±1 MHz of carrier frequency)
	Input level range (transmission power)	+10 to +40 dBm (average power of burst signal)
I/Q input (Option 03)	Measurement range	≥65 dB(10 MHz to 1.7 GHz), ≥75 dB (1.7 to 8.5 GHz) *At carrier frequency range 800 MHz to 1.7 GHz
	Input level range: 0.3 to 1.5 Vp-p Input impedance: 5 kΩ, AC/DC coupling (switchable) Measurement items: Modulation, amplitude, occupied bandwidth	

• **Option 14: Digital MCA measurement software (for Digital MCA)**

The following specifications are guaranteed if the internal level is optimized using the auto range of the MS8604A calibration function.

Maximum input level		10 W (average power), 50 W (peak power: ≤1 ms)
Modulation/ frequency measurement	Frequency range	400 kHz to 2.1 GHz
	Input level range	-10 to +40 dBm (average power of burst signal) *When using the low power input connector, measurement to levels 20 dB lower than the above is possible.
	Carrier frequency (phase trace method)	Accuracy: ± (accuracy of reference oscillator +5 Hz)
	Modulation accuracy	Accuracy: ±3% (normal slot), ±4% (sub slot)
	Transmission rate	Range: ±100 ppm, Accuracy: ±2 ppm (normal slot)
	Waveform display	Constellation display
	Measurement time	≤2 s (except transmission rate measurement), ≤10 s (transmission rate measurement)
Amplitude measurement	Frequency range	10 MHz to 2.1 GHz
	Input level range	+10 to +40 dBm (average power of burst signal)
	Antenna power measurement	Accuracy: ±10% (using high power input connector after calibration with MA4601A Power Sensor)
	Leakage power at carrier-off	Measurement range in Normal mode: ≤55 dB Average noise level in Wide dynamic range mode: ≤-60 dBm (100 MHz ≤frequency ≤2.1 GHz)
	Amplitude waveform display	Displays amplitude waveform while synchronizing with modulation data (synchronous symbol) of measured signal Display time: 108 ms (displays frame), 18 ms (displays slot), 3.6 ms (displays rising/falling)
	Measurement time	≤2 s
Impedance	50 Ω, VSWR: ≤1.2	

Continued on next page

Occupied frequency bandwidth measurement	Frequency range	10 MHz to 2.1 GHz
	Input level range	+10 to +40 dBm (average power of burst signal)
	Measurement method	Standard mode: Displays results of occupied bandwidth measurement after measuring signal with spectrum analyzer; measurement time: approx. 50 s High speed mode: Displays results of occupied bandwidth measurement after FFT of measured signal; measurement time: ≤ 1 s
Adjacent channel power	Frequency range	100 MHz to 2.1 GHz
	Input level range	+10 to +40 dBm
	Measurement method	Standard mode: Displays results of leakage power of adjacent channel measurement after measuring signal with spectrum analyzer; measurement time: approx. 50 s High speed mode: Displays results of leakage power of adjacent channel measurement after measuring signal passed through internal filter (bandwidth: 18 kHz); measurement time: ≤ 2 s
	Measurement range	High-speed mode: Ratio of average power of burst signal to value of leakage power of adjacent channel at burst-on time ≤ 58 dB (standard mode, high speed mode)
Spurious measurement	Frequency range	10 MHz to 8.5 GHz (except frequency range ± 1 MHz of carrier frequency)
	Input level range (transmission power)	+10 to +40 dBm (burst average power)
	Measurement range	≤ 65 dB (10 MHz to 1.7 GHz), ≤ 75 dB (1.7 to 8.5 GHz) *For carrier frequency range 850 MHz to 1.7 GHz
I/Q input (Option 03)	Input level range: 0.3 to 1.5 Vp-p Input impedance: 5 k Ω , AC/DC coupling (switchable) Measurement items: Modulation, amplitude, occupied bandwidth	

• **Option 15: Measurement software (for GMSK)**

The following specifications are guaranteed if the internal level is optimized using the auto range of the MS8604A calibration function.

Maximum input level		+40 dBm
General GMSK	Frequency	10 MHz to 3 GHz
	Input level	-10 to +40 dBm (high power input), -30 to +20 dBm (low power input)
	Setting	Bit rate: 100 bps to 1.25 Mbps (resolution: 0.1 bps) BT: 0.2 to 1.0 (bit rate: 100 bps to 160 kbps), 0.2 to 0.5 (bit rate: 160 kbps to 1.25 Mbps) Analysis bit number: 50 to 1000 bits Frame length: Analysis bit number - 4000 bits (continuous signal), (analysis bit number x 2) - 4000 bits (burst signal) Measurement signal: Continuous signal, burst signal
	Modulation/frequency measurement (phase trace method)	Measurement item: Carrier frequency, phase error Waveform display: Eye pattern, trellis, phase error vs. bit number, amplitude error vs. bit number, I/Q diagram
	Amplitude measurement	Measurement item: Transmission power (average power of burst signal) Waveform: Displays amplitude waveform while synchronizing with modulation data (rise/fall, slot, and frame changeable) Impedance: 50 Ω , VSWR: ≤ 1.2 (high power input connector)
	FM deviation measurement	Measurement item: Maximum frequency deviation Waveform: FM demodulation waveform (continuous demodulation or eye pattern changeable), display range = standard frequency deviation x 2
	Occupied bandwidth measurement	Displays results of occupied bandwidth measurement (99%) after FFT of measurement signal
GSM, DCS1800 (PCN)	Modulation/frequency measurement (phase trace method)	Frequency: 10 MHz to 2.1 GHz Input level: -10 to +40 dBm (high power input), -30 to +20 dBm (low power input) Carrier frequency measurement accuracy: \pm (reference oscillator accuracy +10 Hz) Phase error measurement (residual phase error): $\leq 0.5^\circ$ rms, $\leq 2^\circ$ peak Waveform display: Eye pattern, trellis, phase error vs. bit number, amplitude error vs. bit number, I/Q diagram Measurement time: ≤ 1 s (measured at mobile station), ≤ 1 s (measured at base station)
	Amplitude measurement	Frequency: 10 MHz to 2.1 GHz Input level: +10 to +40 dBm (high power input), -10 to +20 dBm (low power input) Transmission power measurement accuracy: ± 0.4 dB ($\pm 10\%$) *After calibration using MA4601A Power Sensor, at high power input connector; linearity: +0.3 dB (at 0 to -30 dB) Leakage power during carrier-off Measurement range in Normal mode: ≥ 55 dB (ratio between transmission power and average noise level) Average noise level in Wide dynamic range mode: ≤ -50 dBm (100 MHz \leq frequency ≤ 2.1 GHz, at high power input) Waveform: Displays amplitude waveform while synchronizing with modulation data Measurement time: ≤ 1 s (measured at mobile station), ≤ 2 s (measured at base station)
	FM deviation measurement	Same as general GMSK measurement
	Occupied bandwidth measurement	Same as general GMSK measurement
	Output RF spectrum	Available, combined with the MX3518A
	Spurious emissions	Available, combined with the MX3518A

Continued on next page

DECT	Modulation/frequency measurement (phase trace method)	Same as general GMSK measurement
	Amplitude measurement	Frequency: 10 MHz to 2.1 GHz Input level: +10 to +40 dBm (high power input), -10 to +20 dBm (low power input) Transmission power measurement accuracy: ±0.4 dB (±10%) *After calibration using MA4601A Power Sensor, at high power input connector; input level: ≥+15 dBm Leakage power during carrier-off Measurement range in Normal mode: ≥50 dB (ratio between transmission power and average noise level) Average noise level in Wide dynamic range mode: ≤-45 dBm (100 MHz ≤frequency ≤2.1 GHz, at high power input) Waveform: Displays amplitude waveform while synchronizing with modulation data Measurement time: ≤2 s (except for double slot measurement)
	FM deviation measurement	Frequency: 10 MHz to 2.1 GHz Input level: +10 to +40 dBm (high power input), -10 to +20 dBm (low power input) Maximum frequency deviation: Measurement of section specified by marker Residual FM: ≤±5 kHz peak Average frequency measurement: Measurement of section specified by marker Waveform: FM demodulation waveform (continuous demodulation or eye pattern changeable) Measurement time: ≤2 s (except for double slot measurement)
	Occupied bandwidth Measurement	Same as general GMSK measurement
	Emissions due to modulation	Available, combined with the MX3519A
	Emissions due to transmitter transients	Available, combined with the MX9516A
CT2	Spurious emissions	Available, combined with the MX9516A
	Modulation/frequency measurement (phase trace method)	Same as general GMSK measurement
	Amplitude measurement	Frequency: 10 MHz to 2.1 GHz Input level: +10 to +40 dBm (high power input), -10 to +20 dBm (low power input) Transmission power measurement accuracy: ±0.4 dB (±10%) *After calibration using MA4601A Power Sensor, at high power input connector Leakage power during carrier-off Measurement range in Normal mode: ≥60 dB (ratio between transmission power and average noise level) Average noise level in Wide dynamic range mode: ≤-50 dBm (100 MHz ≤frequency ≤2.1 GHz, at high power input) Waveform: Displays amplitude waveform while synchronizing with modulation data Measurement time: ≤1 s (except for multiplex-3 measurement)
	FM deviation measurement	Frequency: 10 MHz to 2.1 GHz Input level: +10 to +40 dBm (high power input), -10 to +20 dBm (low power input) Maximum frequency deviation: Measurement of section specified by marker Residual FM: ≤±200 Hz peak (10 MHz ≤frequency ≤2.1 GHz) Average frequency measurement: Measurement of section specified by marker Waveform: FM demodulation waveform (continuous demodulation or eye pattern changeable) Measurement time: ≤1 s (except for multiplex-3 measurement)
	Occupied bandwidth measurement	Same as general GMSK measurement
	Adjacent channel power	Available, combined with the MX3520A
	Out of band power arising from transmitter transients	Available, combined with the MX3520A
Spurious emissions	Available, combined with the MX3520A	
I/Q input (Option 03)	Input level range: 0.3 to 1.5 Vp-p Input impedance: 5 kΩ, AC/DC coupling (switchable) Measurement items: Modulation, amplitude, occupied bandwidth	

• Option 16: Measurement software (for π/4 DQPSK)

The following specifications are guaranteed if the internal level is optimized using the auto range of the MS8604A calibration function.

Maximum input level	+40 dBm	
General-purpose π/4 DQPSK	Frequency	10 MHz to 4 GHz
	Input level	-10 to +40 dBm (high power input), -30 to +20 dBm (low power input)
	Setting	Symbol rate: 1 to 600 k symbol/s (2 to 1200 kb/s), setting resolution: 0.1 symbol/s α (roll-off factor): 0.2 to 1.0 (symbol rate: 1 to 320 k symbol/s), 0.2 to 0.5 (symbol rate: 320 to 600 k symbol/s), setting resolution: 0.01 Number of analysis symbols: 48 to 1000 symbols Frame length: Number of analysis symbols — 5800 symbols (continuous signal), (number of analysis symbols x 2) — 5800 symbols (burst signal) Measurement signal: Continuous signal, burst signal
	Modulation/frequency measurement (phase trace method)	Measurement item: Carrier frequency, modulation accuracy Waveform: Displays constellation, eye pattern, vectors error vs. symbol number, phase error vs. symbol number, amplitude error vs. symbol number
	Amplitude measurement	Measurement item: Transmission power (average power of burst signal) Waveform: Displays amplitude waveform while synchronizing with modulation data (rise/fall, slot, and frame changeable) Impedance: 50 Ω, VSWR: ≤1.2 (high power input connector)
	Occupied bandwidth measurement	Displays results of occupied bandwidth measurement (99%) after FFT of measurement signal

Continued on next page

WCPE	Modulation/frequency measurement (phase trace method)	Frequency: 10 MHz to 2.1 GHz Input level: 0 to +40 dBm (high power input), -20 to +20 dBm (low power input) Carrier frequency measurement accuracy: \pm (reference oscillator accuracy +10 Hz) Modulation accuracy (residual vector error): $\leq 1\%$ rms, $\leq 3\%$ peak Waveform: Displays constellation, eye pattern, vectors error vs. symbol number, phase error vs. symbol number, amplitude error vs. symbol number Measurement time: ≤ 2 s
	Amplitude measurement	Frequency: 10 MHz to 2.1 GHz Input level: +15 to +40 dBm (high power input), -5 to +20 dBm (low power input) Transmission power measurement accuracy: ± 0.4 dB ($\pm 10\%$) *After calibration using MA4601A Power Sensor, at high power input connector Leakage power during carrier-off Measurement range in Normal mode: ≥ 55 dB (ratio between transmission power and average noise level) Average noise level in Wide dynamic range mode: ≤ -50 dBm (100 MHz \leq frequency \leq 2.1 GHz, at high power input) Waveform: Displays amplitude waveform while synchronizing with modulation data Measurement time: ≤ 2 s
	Occupied bandwidth measurement	Same as general-purpose $\pi/4$ DQPSK measurement
RCR STD-39 ($\pi/4$ DQPSK digital mobile communication system for public works)	Modulation/frequency measurement (phase trace method)	Frequency: 400 kHz to 2.1 GHz Input level: -10 to +40 dBm (high power input), -30 to +20 dBm (low power input) Carrier frequency measurement accuracy: \pm (reference oscillator accuracy +1 Hz) Modulation accuracy (residual vector error): $\leq 0.5\%$ rms, $\leq 2\%$ peak Waveform: Displays constellation, eye pattern, vectors error vs. symbol number, phase error vs. symbol number, amplitude error vs. symbol number Measurement time: ≤ 1 s
	Amplitude measurement	Frequency: 10 MHz to 2.1 GHz Input level: +10 to +40 dBm (high power input), -10 to +20 dBm (low power input) Transmission power measurement accuracy: ± 0.4 dB ($\pm 10\%$) *After calibration using MA4601A Power Sensor, at high power input connector Leakage power during carrier-off Measurement range in Normal mode: ≥ 65 dB (ratio between transmission power and average noise level) Average noise level in Wide dynamic range mode: ≤ -60 dBm (100 MHz \leq frequency \leq 2.1 GHz, at high power input) Waveform: Displays amplitude waveform while synchronizing with modulation data Measurement time: ≤ 1 s
	Occupied bandwidth measurement	Same as general-purpose $\pi/4$ DQPSK measurement
PACS	Modulation/frequency measurement (phase trace method)	Frequency: 10 MHz to 2.1 GHz Input level: -10 to +40 dBm (high power input), -30 to +20 dBm (low power input) Carrier frequency measurement accuracy: \pm (reference oscillator accuracy +10 Hz) Modulation accuracy (residual vector error): $\leq 1\%$ rms, $\leq 3\%$ peak Waveform: Displays constellation, eye pattern, vectors error vs. symbol number, phase error vs. symbol number, amplitude error vs. symbol number Measurement time: ≤ 1 s
	Amplitude measurement	Frequency: 10 MHz to 2.1 GHz Input level: +10 to +40 dBm (high power input), -10 to +20 dBm (low power input) Transmission power measurement accuracy: ± 0.4 dB ($\pm 10\%$) *After calibration using MA4601A Power Sensor, at high power input connector Leakage power during carrier-off Measurement range in Normal mode: ≥ 55 dB (ratio between transmission power and average noise level) Average noise level in Wide dynamic range mode: ≤ -50 dBm (100 MHz \leq frequency \leq 2.1 GHz, at high power input) Waveform: Displays amplitude waveform while synchronizing with modulation data and CRC data (mobile station measurement) Measurement time: ≤ 1 s
	Occupied bandwidth measurement	Same as general-purpose $\pi/4$ DQPSK measurement
TETRA	Modulation/frequency measurement (phase trace method)	Frequency: 400 kHz to 2.1 GHz Input level: -10 to +40 dBm (high power input), -30 to +20 dBm (low power input) Carrier frequency measurement accuracy: \pm (reference oscillator accuracy +1 Hz) Modulation accuracy (residual vector error): $\leq 0.5\%$ rms/ $\leq 2\%$ peak (symbol time), $\leq 0.7\%$ rms/ $\leq 3\%$ peak (1/2 symbol time) Waveform: Displays constellation, eye pattern, vectors error vs. symbol number, phase error vs. symbol number, amplitude error vs. symbol number Measurement time: ≤ 1 s
	Amplitude measurement	Frequency: 10 MHz to 2.1 GHz Input level: +10 to +40 dBm (high power input), -10 to +20 dBm (low power input) Transmission power measurement accuracy: ± 0.4 dB ($\pm 10\%$) *After calibration using MA4601A Power Sensor, at high power input connector Leakage power during carrier-off Measurement range in Normal mode: ≥ 65 dB (ratio between transmission power and average noise level) Average noise level in Wide dynamic range mode: ≤ -60 dBm (100 MHz \leq frequency \leq 2.1 GHz, at high power input) Waveform: Displays amplitude waveform while synchronizing with modulation data Measurement time: ≤ 1 s
	Occupied bandwidth measurement	Same as general-purpose $\pi/4$ DQPSK measurement
I/Q input (Option 03)		Input level range: 0.3 to 1.5 Vp-p Input impedance: 5 k Ω , AC/DC coupling (switchable) Measurement items: Modulation, amplitude, occupied bandwidth

Ordering information

Please specify model/order number, name, and quantity when ordering.

Model/Order No.	Name
MS8604A	Main frame Digital Mobile Radio Transmitter Tester
	Standard accessories
J0114A	Coaxial cord, UG-21D/U · RG-9A/U · UG-21D/U, 1 m: 1 pc
	Power cord, 2.5 m: 1 pc
P0005	PMC (32 KB): 1 pc
MA4601A	Power Sensor: 1 pc
J0370N	Power sensor connector cable, 0.5 m: 1 pc
F0014	Fuse, 6.3 A: 2 pcs
W0682AE	MS8604A operation manual: 1 copy
	Options
MS8604A-01	Reference quartz oscillator (aging rate: $\leq 5 \times 10^{-9}$ /day)
MS8604A-02	RS-232C interface (for external control)
MS8604A-03	I/Q input
MS8604A-11	Measurement software Ver. 3 (PDC, added to the MS8604A firmware at the factory)
MS8604A-12	Measurement software Ver. 3 (PHS, added to the MS8604A firmware at the factory)
MS8604A-13	Measurement software Ver. 3 (NADC, added to the MS8604A firmware at the factory)
MS8604A-14	Measurement software Ver. 2 (Digital MCA, added to the MS8604A firmware at the factory)
MS8604A-15	Measurement software Ver. 2 (GMSK, added to the MS8604A firmware at the factory)
MS8604A-16	Measurement software ($\pi/4$ DQPSK, added to the MS8604A firmware at the factory)
W0722AE	Measurement software operation manual (supplied with Option 14)
W0876AE	Measurement software operation manual (supplied with Option 15)
W0973AE	Measurement software operation manual (supplied with Option 16)

Previously-purchased MS8604A measurement software options (Option 11, Option 12, Option 13, Option 14 and Option 15) can be upgraded to the latest version (with fee). For details, please contact your sales representative.

Model/Order No.	Name
	Application software (supplied with PMC)
	$\pi/4$ DQPSK Analysis Software (for MS8604A-11/12/13)
	Digital MCA Analysis Software (for MS8604A-14)
	GSM Application Software (for MS8604A-15)
	DECT Application Software (for MS8604A-15)
	CT2 Application Software (for MS8604A-15)
	Peripheral equipments and parts
	JIS Type PTA Keyboard
	ASCII Type PTA Keyboard
	GPIB cable, 1 m
	GPIB cable, 2 m
	PMC, 64 KB
	PMC, 128 KB
	PMC, 256 KB
	PMC, 512 KB
	Range Calibrator
	50 Ω Coaxial Switch (DC to 3 GHz, 50 Ω)
	Branch (DC to 1.7 GHz, 40 dB)
	Directional Coupler (0.8 to 3 GHz, 30 dB)
	CM Directional Coupler (25 to 500 MHz, 50 Ω , N type)
	CM Directional Coupler (100 to 1700 MHz, 50 Ω , N type)
	Fixed attenuator for high-power (30 dB, 30 W, DC to 8 GHz)
	Coaxial adapter (NC-P · BNC-J)
	DC block (10 MHz to 12.4 GHz, NARDA product)
	Protective cover
	Front handle kit (2 pcs/set)
	Joint plate (4 pcs/set)
	Rack mount kit
	Hard carrying case (with protective cover and casters)

DIGITAL MODULATION SIGNAL GENERATOR

MG3681A

250 kHz to 3 GHz

W-CDMA Device, Mobile Equipment, Base Station Test

CE GPIB

The MG3681A is a high performance digital modulation signal generator that incorporates a broadband vector modulator. It generates the complex high-accuracy signals required for research and development to mass-production of digital mobile communication systems and related devices.

It has a frequency range of 250 kHz to 3 GHz, covering the frequency bands of all major mobile communications systems. In addition, it uses quadrature vector modulation to provide high-quality frequency characteristics, distortion characteristics, and S/N ratio. It can perform accurate sensitivity tests of receivers in high-speed modulation communication systems, as well as test transmitter adjacent-channel power characteristics.

Expansion options such as the MU368040A CDMA Modulation Unit, which generates modulation signals for W-CDMA communication systems, can be installed in the seven expansion slots. Various modulation signal waveforms can be generated with the expansion units and associated software.

The MG3681A also has superior AM and FM analog modulation functions for testing conventional analog communications systems. Its high signal purity and various functions such as memory and sweep capabilities are useful in general-purpose signal generation applications.

Features

- Comprehensive expandability
- Excellent analog performance

Performance and functions

• Broadband vector modulation

The modulation frequency response of ± 3 dB at the modulation frequency from DC to 30 MHz is achievable by the high-speed base band signal processor and broadband quadrature modulator. The MG3681A provides broadband vector modulation for W-CDMA and other high-speed data communication systems. Accurate broadband vector modulation is also available by using the external I/Q signals as well as internal modulation using the optional digital modulation unit installed.

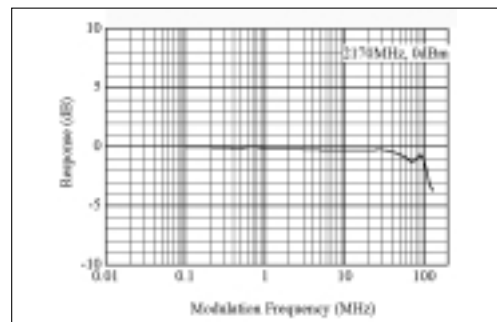

Vector modulation frequency response

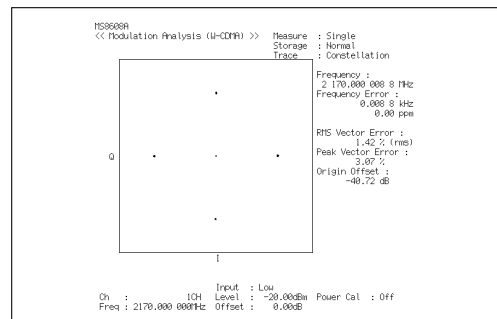

Vector modulation accuracy

• Excellent adjacent channel power characteristics

Adjacent channel power characteristic is important for evaluating devices and radio receivers. The MG3681A provides excellent adjacent channel power characteristics by using a proven circuit configuration. It offers excellent rejection of adjacent channel signals, such as -68 dBc/ 3.84 MHz (1 code, typical) for adjacent channel and -75 dBc/3.84 MHz (1 code, typical) for 1st alternate channel. This makes the MG3681A an excellent choice for evaluating intermodulation distortion of power amplifiers.

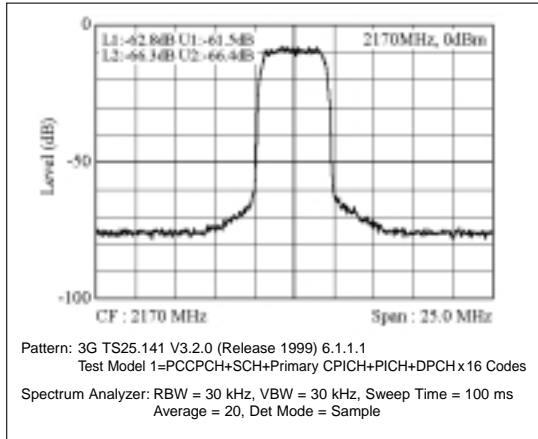

Adjacent channel power characteristic (16 code multiwave)

• High-resolution output level setting of 0.01 dB

The output level can be set with 0.01 dB resolution across the entire level range. This is useful for device tests, level calibration of power meter etc., requiring precise level settings.

• Excellent level accuracy

Even low levels can be output with high accuracy due to use of a high-precision, high-reliability step attenuator and high-speed level calibration method. As a result, highly sensitive receivers can be measured accurately.

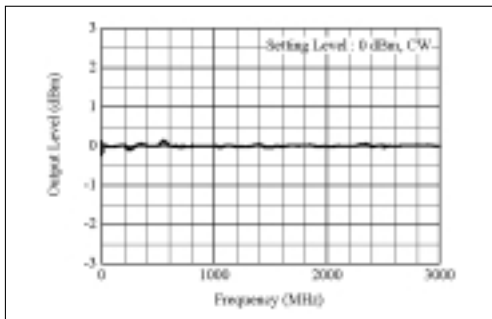

Output level frequency response

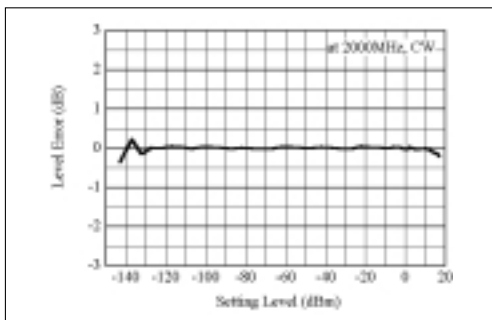

Output level accuracy

• Excellent noise characteristics

The MG3681A can be used for interference testing of radio receivers and as sources of various local oscillator and reference signals.

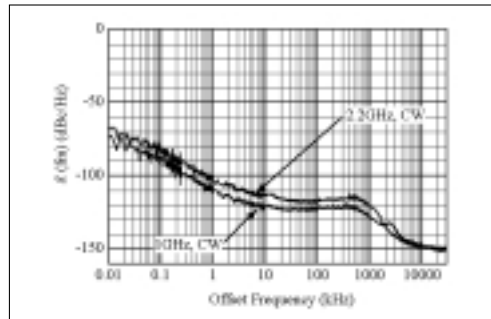

SSB phase noise characteristics

• Compatibility with W-CDMA systems

The MG3681A can generate up-link and down-link signals with the W-CDMA modulation standard corresponding to 3GPP (FDD) with the installation of the MX368041A W-CDMA Software and the MU368040A CDMA Modulation Unit.

Connection with mobile equipment and base stations

For down-link simulation, the MG3681A outputs P-CCPCH, P-SCH and S-SCH to synchronize with mobile equipment for up to three base stations simultaneously. It incorporates an external trigger to control the generation timing of the CDMA modulation waveform for base-station connection tests.

Optional filter factor

The baseband filter can be switched between Nyquist and root-Nyquist, and the roll-off ratio can be set between 0.10 and 1.00 in step of 0.01.

Modulation data downloading

Modulation can be performed using the data downloaded by the MX368041A W-CDMA Software. In addition, the symbol data downloaded before diffusion can be used to generate channel formats such as DPCH and PRACH when physical format specification changes occur. It also allows insertion of special test patterns and bit errors. The waveform data can also be downloaded after diffusion to control the crest factors of multiple waves.

Power control function

Using the externally inputted TTL level signals, the channel power can be controlled in 1 dB and 1 slot steps. In addition, the internal program function enables the code power to be programmed for every slot in each channel at the maximum period of 64 slots. This is useful for checking the power control function.

Multiwaves generation

The channels that can be set, such as channelization codes and code power, can be increased up to 12 waveforms. The stored waveform table function enables the generation of multiple waveforms up to 512 channels (at Phase 1). In multiwave mode, MG3681A can generate signals with ratios of peak power to average power of up to 18 dB (except base band filtering effect).

Supports chip rates up to 16.5 Mcps

The MG3681A can output a CDMA modulation waveform whose diffusion and modulation methods are in accordance with 3GPP standard at the chip rate of 1.6 to 16.5 Mcps (set resolution: 1 cps)

Specifications

• MG3681A main frame

Frequency	Range	250 kHz to 3000 MHz, Resolution: 0.01 Hz																						
	Accuracy	Depends on installed reference oscillator, Reference frequency accuracy: \pm (5% of FM setting deviation + 5 Hz) for frequency modulation																						
	Internal reference oscillator	Aging rate: $\pm 1 \times 10^{-6}$ /year, Temperature stability: $\pm 1 \times 10^{-6}$ (0° to 50°C)*1																						
	External reference input	10 MHz/13 MHz auto-switching, ± 10 ppm, ≥ 0.7 V(p-p)/50 Ω (AC coupled), BNC connector (rear panel)																						
	Buffer output	10 MHz, TTL level (DC coupled), BNC connector (rear panel)																						
	Switching time	≤ 20 ms (response time from final command to ± 500 Hz of set frequency on GPIB at CW, ALC on, except when setting frequency is crossing over 600 MHz and 1010 MHz)																						
Output level	Range	-143 to +13 dBm (settable range: -143 to +17 dBm)																						
	Unit	dBm, W, dB μ V, V (dB μ V, V selected terminate/open voltage display)																						
	Resolution	0.01 dB (dBm, dB μ V units), 3 digit (W, V units)																						
	Frequency response	± 1 dB (CW, ALC on, 0 dBm)																						
	Accuracy	CW, ALC on <table border="1" style="margin-left: 20px;"> <thead> <tr> <th rowspan="2">Level</th> <th colspan="2">Frequency</th> </tr> <tr> <th>≤ 1 GHz</th> <th>> 1 GHz</th> </tr> </thead> <tbody> <tr> <td>$\leq +13$ dBm, ≥ -127 dBm</td> <td>± 1 dB</td> <td>± 2 dB</td> </tr> <tr> <td>< -127 dBm</td> <td>± 2 dB</td> <td>± 3 dB</td> </tr> </tbody> </table>			Level	Frequency		≤ 1 GHz	> 1 GHz	$\leq +13$ dBm, ≥ -127 dBm	± 1 dB	± 2 dB	< -127 dBm	± 2 dB	± 3 dB									
	Level	Frequency																						
		≤ 1 GHz	> 1 GHz																					
	$\leq +13$ dBm, ≥ -127 dBm	± 1 dB	± 2 dB																					
	< -127 dBm	± 2 dB	± 3 dB																					
	Output connector	50 Ω , N-type connector (front panel)																						
Switching time	≤ 50 ms (normal mode), ≤ 100 ms (safety mode), ≤ 10 ms (continuous mode) *Response time from final command to ± 0.5 dB of final level on GPIB at CW, ALC on																							
Special setting mode	Continuous mode: Level continuously adjustable in set value range of ± 10 dB (dBm, dB μ V units only) For vector modulation by optional digital modulation unit, continuous mode variance depends on modulation setting Safety mode: Mechanical attenuator decreases level to prevent generation of high-level signal spikes																							
ALC mode	ALC on Usage: Continuous wave or pulse modulation wave (burst wave) with RF On time of 10 μ s or more ALC time constant: Auto, 500 ns, 2.4 μ s, 5 μ s, 24 μ s, 50 μ s, 240 μ s, 500 μ s selectable At Auto, automatically selected depending on frequency, AM and vector modulation [when digital modulation unit (option) is used] The ALC time constant is automatically selected, depending on the set frequency, regardless of the time constant selected on the front panel ALC off Usage: Pulse modulation wave (burst wave) whose RF on time is less than 10 μ s Restrict item: Without AM ALC calibration: Automatic during ALC Calibration operation and at frequency/level setting change																							
Signal purity	Spurious	Harmonics: < -30 dBc Non harmonic: <table border="1" style="margin-left: 20px;"> <thead> <tr> <th>Frequency</th> <th>15 kHz to 300 MHz offset</th> <th>> 300 MHz offset</th> <th>Fixed frequency spurious</th> </tr> </thead> <tbody> <tr> <td>≤ 2500 MHz</td> <td>< -60 dBc</td> <td>< -30 dBc</td> <td>-50 dBc (660, 1320 MHz)</td> </tr> <tr> <td>> 2500 MHz</td> <td colspan="2">< -30 dBc</td> <td>-</td> </tr> </tbody> </table> Those related power: < -40 dBc *CW, ≤ 0 dBm			Frequency	15 kHz to 300 MHz offset	> 300 MHz offset	Fixed frequency spurious	≤ 2500 MHz	< -60 dBc	< -30 dBc	-50 dBc (660, 1320 MHz)	> 2500 MHz	< -30 dBc		-								
	Frequency	15 kHz to 300 MHz offset	> 300 MHz offset	Fixed frequency spurious																				
≤ 2500 MHz	< -60 dBc	< -30 dBc	-50 dBc (660, 1320 MHz)																					
> 2500 MHz	< -30 dBc		-																					
SSB phase noise	< -118 dBc/Hz (≥ 10 MHz, ≤ 1010 MHz), < -112 dBc/Hz (> 1010 MHz) *At CW, 20 kHz offset																							
AM	Range	0 to 100% (cannot set internal/external modulation independently), Resolution: 0.1%																						
	Modulation frequency response	≤ 0 dBm, ALC on, in band of ± 1.5 dB based on modulation frequency of 1 kHz <table border="1" style="margin-left: 20px;"> <thead> <tr> <th rowspan="2">Frequency</th> <th rowspan="2">Lower limit frequency</th> <th colspan="3">Upper limit frequency</th> </tr> <tr> <th colspan="2">Vector modulation and wideband AM off</th> <th>Vector modulation or wideband AM on</th> </tr> <tr> <td>≥ 0.4 MHz, < 2 MHz</td> <td rowspan="3">DC (Internal modulation, External modulation DC coupled), 20 Hz (External modulation AC coupled)</td> <td>AM: 30%</td> <td>AM: 80%</td> <td>AM: 30%</td> </tr> <tr> <td>≥ 2 MHz, < 10 MHz</td> <td>3 kHz</td> <td>1 kHz</td> <td rowspan="2">1 kHz</td> </tr> <tr> <td>≥ 10 MHz</td> <td>10 kHz</td> <td>10 kHz</td> </tr> </thead> <tbody> </tbody> </table>			Frequency	Lower limit frequency	Upper limit frequency			Vector modulation and wideband AM off		Vector modulation or wideband AM on	≥ 0.4 MHz, < 2 MHz	DC (Internal modulation, External modulation DC coupled), 20 Hz (External modulation AC coupled)	AM: 30%	AM: 80%	AM: 30%	≥ 2 MHz, < 10 MHz	3 kHz	1 kHz	1 kHz	≥ 10 MHz	10 kHz	10 kHz
	Frequency	Lower limit frequency	Upper limit frequency																					
			Vector modulation and wideband AM off		Vector modulation or wideband AM on																			
	≥ 0.4 MHz, < 2 MHz	DC (Internal modulation, External modulation DC coupled), 20 Hz (External modulation AC coupled)	AM: 30%	AM: 80%	AM: 30%																			
	≥ 2 MHz, < 10 MHz		3 kHz	1 kHz	1 kHz																			
≥ 10 MHz	10 kHz		10 kHz																					
Internal modulation	Depends on AF synthesizer (Option 21)																							
External modulation	2 V(p-p) approx., 600 Ω , AC/DC coupled switchable, BNC connector (front panel)																							
Modulation signal polarity	Positive/negative switchable																							
FM	Range	0 to 1000 kHz (≥ 10 MHz, ≤ 1010 MHz), 0 to 2000 kHz (> 1010 MHz) *Cannot set internal/external modulation independently.																						
	Resolution	10 Hz (0 to 10 kHz deviation), 100 Hz (10.1 to 100 kHz deviation), 1 kHz (101 to 1000 kHz deviation), 10 kHz (1010 to 2000 kHz deviation)																						
	Modulation frequency response	DC to 20 kHz (internal modulation, external modulation DC coupled), 20 Hz to 20 kHz (external modulation AC coupled) *In band of ± 1 dB based on modulation frequency of 1 kHz																						
	Internal modulation	Depends on AF synthesizer (Option 21)																						
	External modulation	2 V(p-p) approx., 600 Ω , AC/DC coupled switchable, BNC connector (front panel)																						
	Modulation signal polarity	Positive/negative switchable																						

Continued on next page

øM	Range	0 to 6.28 rad (≥ 10 MHz, ≤ 1010 MHz), 0 to 12.56 rad (> 1010 MHz) *Cannot set internal/external modulation independently.
	Unit	rad, deg
	Resolution	rad unit: 0.01 rad, deg unit: 1 deg
	Modulation frequency response	DC to 20 kHz (internal modulation, external modulation DC coupled), 20 Hz to 20 kHz (external modulation AC coupled) *In band of ± 1 dB based on modulation frequency of 1 kHz
	Internal modulation	Depends on AF synthesizer (Option 21)
	External modulation	2 V(p-p) approx., 600 Ω , AC/DC coupled switchable, BNC connector (front panel)
	Modulation signal polarity	Positive/negative switchable
Wideband AM	Modulation frequency response	DC to 15 MHz (± 2 dB bandwidth), DC to 30 MHz (± 3 dB bandwidth) *External modulation, input level: 0.9 V(p-p), ≥ 100 MHz, ≤ 0 dBm, modulation frequency of 1 kHz
	Internal modulation	Depends on installed digital modulation unit (option)
	External modulation	≤ 1 V(p-p), 50 Ω , BNC connector (front panel), sensitivity: 1 V(p-p) = 100%
Pulse modulation	On/off ratio	> 60 dB
	Rise/fall time	< 100 ns (external modulation)
	Minimum pulse width	< 500 ns (external modulation)
	Pulse repetition frequency	DC to 1 MHz (external modulation, ALC off)
	Internal modulation	Depends on installed digital modulation unit (option)
	External modulation	TTL level, positive logic, 50 Ω , BNC connector (front panel)
Vector modulation	Modulation frequency response	DC to 15 MHz (± 2 dB bandwidth), DC to 30 MHz (± 3 dB bandwidth) *External modulation, input level: 0.5 V(rms), ≥ 100 MHz, ≤ 0 dBm, modulation frequency of 1 kHz
	Vector error	$\leq 2.5\%$ (rms) *External modulation, input level: 0.5 V(rms), ≥ 100 MHz, ≤ 0 dBm, 3.84 Msps QPSK modulation
	Internal modulation	Depends on installed digital modulation unit (option)
	External modulation	$\sqrt{I^2+Q^2} = 0.5$ V(rms), I/Q = ± 1.5 V(peak), 50 Ω , BNC connector (front panel)
	Quadrature degree adjustment function	Adjustment range: $\geq \pm 1$ deg
I/Q change	I, Q signal changeable (RF spectrum invert)	
Simultaneous modulation	Modulation depth and deviation same for combinations below: AM (internal/external), FM (internal/external), øM (internal/external) Frequency and waveform of modulation signal source same for combinations below: AM (internal)/FM (internal), AM (internal)/øM (internal) Simultaneous modulation impossible as below: FM/øM, wideband AM/vector modulation, vector (internal)/vector (external) modulation	
AF signal output	Depends on AF synthesizer (Option 21)	
I/Q signal output*2	Output level	Depends on installed digital modulation unit (option)
	Signal source	Depends on installed digital modulation unit (option)
	Output connector	50 Ω , BNC connector (front panel)
Memory function	Basic parameter memory	512 sets of frequency and level
	All parameter memory	All parameters including 100 sets maximum of analog modulation and digital modulation units (option)
Sweep function	Sweep parameter	Basic parameter memory address
	Sweep pattern	Start address \rightarrow stop address
	Sweep time	1 ms to 600 s (per memory; memory recall time restricts lower limit, resolution: 1 ms)
	Sweep mode	Auto (repetition sweep), single (single sweep)
Special display	Relative display	Frequency, output level (dBm, dB μ V units only)
	Offset display	Frequency (offset range: -3 to $+3$ GHz), output level (offset range: -55 to $+55$ dB, dBm, dB μ V units only)
Display	Size	7.2 inch, 480 x 640 dots, color D-STN
	On/off setting	Panel display on/off
Backup function	All items reset at power-on except following: Input data contents, remote condition, contents of GPIB data being transferred, RPP operation condition, screen condition, main function selections	
Panel lock function	Panel lock	Disable operation of all keys except front panel power key, panel lock key, local key and contrast key
	Knob hold	Disable rotary knob on front panel operation
External interface	GPIB	Controls all functions except power key, local key and contrast key Connector: rear panel
	PC card	Memory card (memory backup, screen hard copy) Connector: JEIDA Ver 4/4.1 PCMCIA Rel 2.0, 1 slot (rear panel)
	Trigger	Executes item specified by command-input signals (3 bits) from following items: Frequency step-up/step-down, output level step-up/step-down, basic parameter recall address up/down, output level on/off Interface: TTL level Connector: D-sub 9-pin, female (rear panel)
Reverse power protection	≤ 50 W (≤ 1 GHz), ≤ 25 W (> 1 GHz), ± 50 V (DC)	
Power	AC 100 to 120/200 to 240 V ($-15/+10\%$, 250 V max, automatic selection), 47.5 to 63 Hz, ≤ 300 VA	
Temperature	Operating: 0° to 50° C, Storage: -20° to 60° C	

Continued on next page

Dimensions and mass	426 (W) x 177 (H) x 451 (D) mm, ≤25 kg (excluding option)
EMC	EN61326: 1997/A1, 1998 (Class A) EN61000-3-2: 1995/A2, 1998 (Class A) EN61326: 1997/A1, 1998 (Annex A)
LVD	EN610101-1: 1993/A2, 1995 (Installation Category II, Pollution degree 2)

*1: Aging rates down to 5×10^{-10} /day are available as reference crystal oscillator (MG3681A Option 01/02).
*2: Possible to expand the function with MG3681A Option 11

• Options

Option 01 (Reference crystal oscillator)	Frequency: 10 MHz Aging rate: $\pm 5 \times 10^{-9}$ /day Start-up characteristics: 1×10^{-7} (After 10 min, compared to frequency after 24 h warm-up) Temperature stability: $\pm 3 \times 10^{-8}$ (0° to 50°C)
Option 02 (Reference crystal oscillator)	Frequency: 10 MHz Aging rate: $\pm 5 \times 10^{-10}$ /day Start-up characteristics: 1×10^{-7} (After 10 min, compared to frequency after 24 h warm-up) Temperature stability: $\pm 5 \times 10^{-8}$ (0 to 50°C)
Option 11 (Additional function of I/Q output)	Functions: Adds level, offset setting, and differential output functions to I/Q output Level Range: 80 to 120% of nominal level, Resolution: 0.1% *2 sets of I/\bar{I} and Q/\bar{Q} set independently, 50 Ω termination Offset Range: -0.5 to +1.5 V, Resolution: 0.5 mV *4 sets of I, \bar{I}, Q, \bar{Q} set independently, 50 Ω termination Quadrature degree variable function Range: ± 5 deg, Resolution: 0.5 deg Differential output: I, Q signals (Using front I/Q input connector) Signal source: Depends on installed digital modulation unit (option) Output connector: 50 Ω, BNC connector (front panel)
Option 21 (AF synthesizer)	Frequency: 0.01 Hz to 400 kHz, Resolution: 0.01 Hz, Accuracy : same as reference oscillator Waveform: Sine, triangular, square, sawtooth Frequency response: ± 1 dB [sine wave, level: 2 V(p-p), offset: 0 V, 600 Ω termination, reference to 1 kHz, 10 Hz to 100 kHz] Harmonics: ≤ -50 dB [sine wave, level: 2 V(p-p), offset: 0 V, 600 Ω termination, 1 kHz] Level Range: 0 to 4 V(p-p), Resolution: 1 mV(p-p), Accuracy: $\pm [8\% \text{ of set level} + 2 \text{ mV(p-p)}]$ *600 Ω termination Offset Range: -2 to +2 V, Resolution: 1 mV, Accuracy: $\pm (8\% \text{ of set level} + 2 \text{ mV})$ *600 Ω termination Output connector: 600 Ω, BNC connector (front panel)

• MU368040A CDMA Modulation Unit (incorporated in the MG3681A)

Usable Software	MX368041A W-CDMA Software
Occupied slot number	2 slots
Firmware back up size	CDMA: 2 Mbyte, DSP: 2 Mbyte, FPGA: 4 Mbyte
Mass	700 g
EMC	Same as MG3681A
LVD	Same as MG3681A

• MX368041A W-CDMA Software (with MG3681A and MU368040A)

System	W-CDMA (FDD)	
Spreading method	Direct sequence	
Modulation method	Up-link: BPSK (data), HPSK (spreading) Down-link: QPSK (data), QPSK (spreading)	
W-CDMA phase	Phase 1, 2, 3 (Phase 2, 3: only for the chip rate)	
Channel number	Phase 1: 1 to 512, Phase 2: 1 to 1024, Phase 3: 1 to 2048	
Spreading factor	Phase 1: 1 to 512, Phase 2: 1 to 1024, Phase 3: 1 to 2048	
Chip rate	Phase 1: 1.6 to 4.125 Mcps, Phase 2: 3.2 to 8.25 Mcps, Phase 3: 6.4 to 16.5 Mcps	
Symbol rate	Chip rate/spreading factor	
Data rate accuracy	Depends on installed reference oscillator in the MG3680 series or depends on external reference oscillator	
Filter mode	ACP (preference to the Adjacent Channel Power ratio), EVM (preference to the Error Vector Magnitude)	
Base band filter	Nyquist or Root Nyquist, Roll off ratio: 0.1 to 1.0, Resolution: 0.01	
Editable code number	1 to 12 (for the settings after spreading process)	
Down-loaded data	Symbol data code number	2 code max. (The available number of external physical data codes that can be downloaded. When the multi-code function is used, the total number is 9 codes.)
	Symbol data length	4 M symbol/1 code (without power sequence), 1 M symbol/1 code (with power sequence)
	Wave data length	Arbitrary wave form data: 512 k word x 2 ch (1 word = 16 bit)
Internal real-time coding channels	P-CCPCH (base station simulation)	

Continued on next page

Spreading code	Base station simulation	Channelization code: Editable for the each 1 to 12 channels Code: OVFSF Setting range: 0 to (spreading factor – 1) Scrambling code*1 Code: Gold sequence Scrambling code number setting: 00000 h to 3FFFF h Scrambling code initial phase setting: 00000 h to 3FFFF h Scrambling code Q-phase offset setting: 00000 h to 3FFFF h Scrambling code period: 00001 h to 40000 h
	Mobile station simulation	Channelization code: Editable for the each 1 to 12 channels Code: OVFSF Setting range: 0 to (spreading factor – 1) Scrambling code*1 Long Code: Gold sequence (HPSK or QPSK) Scrambling code number setting: 00000 h to 1FFFFFF h Scrambling code period setting: 0000001 h to 2000000 h Short*2 Code: 256 chips sync short scrambling sequence Scrambling code number setting: 000000 h to FFFFFFF h
Internal generating data		Pseudo-random pattern (PN 9, PN 15, PN 23), arbitrary 16 bit repeat pattern (CH11, 12 : Variable repeat pattern of max. 32 bit)
Code domain power		–40 to 0 dB, off, resolution: 0.1 dB
Power control	Internal program function	Programmable each channel's slot power, period: 2 to 64 slot, resolution: 1 dB
	External control function	Control the arbitrary code power synchronizing with the slot timing by the external input signal (TTL), resolution: 1 dB
Offset		The frame timing offset from the scrambling code's first phase (resolution: 1 symbol) The offset of the each scrambling code's phase (resolution: 1 chip)
I/Q phase		Symbol point of the I/Q output: 0, $\pi/4$ rad
Aux. signal	Input signals	Data: Physical layer (before the spreading) data input (serial). Frame Clock/Trig: External frame sync. signal input (adjustable the trigger delay) Power Control: External power control input (1 dB step power control of any 1 code) Ref. Clock: Sync. input signal for base-band clock (chip rate x 2 ⁿ) *n: phase 1 = 0 to 2, Phase 2 = 0 to 1, Phase 3 = 0 Input connector: TTL, BNC connector (front panel)
	Output signals	Data Clock: Sync. output signal for data output Data: Symbol data output before spreading Symbol Clock: Symbol clock output Ref. Clock: Base-band clock (chip rate x 2 ⁿ) *n: Phase 1 = 0 to 3, Phase 2 = 0 to 2, Phase 3 = 0 to 1 Frame Clock: Pulse output of frame period Slot Clock: Pulse output of time slot period Code: Exclusive OR data, channelization code and scrambling code Output connector: TTL, BNC connector (rear panel)
I/Q signal	Output level	$\sqrt{I^2+Q^2} = 0.200$ V(rms) *Maximum code number : 1, filter mode: EVM, 50 Ω termination, connector: BNC connector (front panel)
	Vector error	$\leq 3\%$ (rms) *Chip rate: 3.84 Mcps, maximum code number: 1, filter mode: EVM, 18° to 35°C
RF signal	Frequency rage	10 to 3000 MHz
	Output power rage	–143 to +5 dBm (maximum code number: 1 to 7), –143 to +4 dBm (maximum code number: 8 to 12), –143 to +3 dBm (maximum code number: 13 to 15), –143 to +2.14 dBm (maximum code number: 16 to 19), –143 to +2 dBm (maximum code number: 20 to 31), –143 to +1 dBm (maximum code number: 32 to 50), –143 to 0 dBm (maximum code number: ≥ 51)
	Continuous mode range	–10 to +8 dB (maximum code number: except 16 to 19), –10 to +7.14 dB (maximum code number: 16 to 19)
	Burst on/off ratio	>60 dB (1.9 to 2.3 GHz)
	Vector error	$\leq 2\%$ (rms) *1.9 to 2.3 GHz, 0 dBm, chip rate: 3.84 Mcps, maximum code number: 1, filter mode: EVM
	Carrier leak	≤ -30 dBc (≤ 0 dBm, 18° to 35°C, 1.9 to 2.3 GHz)
	Image rejection	≤ -40 dBc (≤ 0 dBm, after calibration, 1.9 to 2.3 GHz)
	Level accuracy	Level accuracy of CW ± 1.2 dB (1.9 to 2.3 GHz, chip rate: 3.84 Mcps, maximum code number: 1, scrambling code: on, power control function: off)
	Adjacent channel power ratio	–64 dBc/3.84 MHz (5 MHz offset), –71 dBc/3.84 MHz (10 MHz offset), –68 dBc/3.84 MHz (typical, 5 MHz offset), –75 dBc/3.84 MHz (typical, 10 MHz offset) *1.9 to 2.3 GHz, –3 dBm, maximum code number: 1, filter mode: ACP, 18° to 35°C, by spectrum analyzer with RMS detector
Spurious	< -60 dBc (1.9 to 2.3 GHz, chip rate: 3.84 Mcps, maximum code number: 1, filter mode: ACP)	
Necessary firmware back up size		CDMA: 300 kbyte, DSP: 250 kbyte, FPGA: 100 kbyte

*1: Equipped with three generators, selectable each channel or off. The start timing of each generator can set with 1 chip resolution.

*2: Only one selectable from three scrambling code generator

Ordering information

Please specify model/order number, name, and quantity when ordering.

Model/Order No.	Name
MG3681A	Main frame Digital Modulation Signal Generator
	Standard accessories
	Power cord, 2.6 m: 1 pc
B0325	GPIB connector shield cap: 1 pc
F0014	Fuse, 6.3 A: 2 pcs
W1708AE	MG3681A operation manual: 1 copy
	Options
MG3681A-01	Reference oscillator (aging rate: 5×10^{-9} /day)
MG3681A-02	Reference oscillator (aging rate: 5×10^{-10} /day)
MG3681A-11	Additional function of I/Q output (level and offset setting, differential output)
MG3681A-21	AF synthesizer (0.01 Hz to 400 kHz, resolution: 0.01 Hz)
	Maintenance service
MG3681A-90	Extension service 3 years
MG3681A-91	Extension service 5 years
	Expansion units
MU368010A	TDMA Modulation Unit*1,*2
MU368040A	CDMA Modulation Unit*1,*2
MU368060A	AWGN Unit*1
	Standard accessories
W1835AE	MU368010A operation manual: 1 copy
W1758AE	MU368040A operation manual: 1 copy
W1955AE	MU368060A operation manual: 1 copy
	Maintenance service
MU368010A-90	Extension service 3 years
MU368010A-91	Extension service 5 years
MU368040A-90	Extension service 3 years
MU368040A-91	Extension service 5 years
MU368060A-90	Extension service 3 years
MU368060A-91	Extension service 5 years
	Softwares*1
MX368011A	PDC Software (for MU368010A)
MX368012A	GSM Device Test Software (for MU368010A)
MX368041A	W-CDMA Software (for MU368040A)
MX368042A	IS-95 Device Test Software (for MU368040A)
	Standard accessories
W1836AE	MX368011A operation manual: 1 copy
W1837AE	MX368012A operation manual: 1 copy
W1759AE	MX368041A operation manual: 1 copy
W1838AE	MX368042A operation manual: 1 copy
	Optional accessories
J0576B	Coaxial cord (N-P · 5D-2W · N-P), 1 m
J0576D	Coaxial cord (N-P · 5D-2W · N-P), 2 m
J0127C	Coaxial cord (BNC-P · RG-58A/U · BNC-P), 0.5 m
J0127A	Coaxial cord (BNC-P · RG-58A/U · BNC-P), 1 m
J0007	GPIB cable, 1 m
J0008	GPIB cable, 2 m
B0329C	Front cover (1MW4U)
B0331C	Front handle (2 pcs/set)
B0332	Joint plate (4 pcs/set)
B0333C	Rack mount kit
B0334C	Carrying case (Hard type, with front cover and casters)

*1: For the details of expansion units and software, refer to the each catalog.

*2: The software is required to use the MU368010A/368040A

DIGITAL MODULATION SIGNAL GENERATOR
MG3670B/C, MG3671A/B, MG3672A
 300 kHz to 2.25/2.75 GHz

For Measuring Signals of Digital Mobile Communication Systems in North America, Europe and Japan



GPIB

4

The MG3670B/C, MG3671A/B and MG3672A are digital modulation signal generators equipped with a high-performance quadrature modulator. They output the signals needed to develop, test, and evaluate digital mobile communications equipment and related devices with expansion units.

The MG3670B/C operates from 300 kHz to 2.25 MHz; the MG3671A/B and MG3672A operate 300 to 2.75 MHz. Both provide a stable and precise output as well as spectrum purity up to +13 dBm, even with modulation. In addition to testing receiver sensitivity and excess input, they can be used for testing IF stage performance and for evaluating device quality. A CMOS-level mode is provided for I/Q signal input. The input frequency band covers the CDMA spread spectrum band, expanding the range of applications.

The MG3670C/3671B/3672A can be expanded by rear panel extension connectors to use for auxiliary signal output functions special to communication system. MG3670B/C, MG3671A/B and MG3672A can be used in combination with up to eight modulation units and a burst function unit simultaneously.

The MG0301C/0302A/0305A/0307A/0311A modulation units have a continuous data generator capable of generating arbitrarily-programmable data signals and ITU-T specification PN9/15 stage PRBS signals. They also have band-limiting filters and can output I/Q baseband signals.

The MG0303A Burst Function Unit uses the frame and slot configuration stipulated by various communication systems and has a modulation pattern generator function and a function for ramp control of carrier burst signals. It can also handle data editing and scrambling.

The MG0310A Modulation Unit generates SS + QPSK/OQPSK modulated (1.2288 Mcps) I/Q baseband signals, supporting the CDMA system (TIA/EIA/IS-95) used in US Digital Cellular Systems and the US Personal Communications Service (PCS).

Anritsu-developed DSP and ASIC technology is used in the MG0310A to achieve superior waveform quality factor (p) and spurious emission characteristics. Channel multiplexed signals are supported for both forward and reverse links. With two MG0310A units mounted in the MG3670C/3671B/3672A, all the test signals required to conform to TIA/EIA/IS-95, -97, and -98 can be generated. Simultaneous outputs from the rear extension connectors using long and short codes, etc., support a wide range of applications including RF related tests, IF stage performance tests, and device and module quality evaluation. (Option 25 is required to install the MG0310A in the MG3670B/3671A. The auxiliary signal output function is not installed, so long/short codes cannot be output.)

The MG0312A QPSK Modulation Unit generates QPSK/OQPSK modulated I/Q baseband signals at 8 high-speed bit rates between 500 kbps and 2.4576 Mbps. Built-in modulation data includes PN7/PN9/PN15/PN23 pseudorandom patterns. Use over a wide range is supported by multiple baseband filters and the Phase Encoding function, which allows modulation data to be voluntarily phase mapped onto a constellation. At the 2.4576 Mbps rate, the evaluation of transmission section devices and modules can be performed such as RF power amplifier for CDMA mobile stations.

Communication systems	Units	
PHS, PDC, PDC_H, NADC, TFTS	MG0301C $\pi/4$ DQPSK Modulation Unit	MG0303B Burst Function Unit
GSM, PCN (DCS1800), CT2	MG0302A GMSK Modulation Unit	
DECT	MG0305A GFSK Modulation Unit	
PACS, WCPE, PHS	MG0307A $\pi/4$ DQPSK Modulation Unit	
TETRA	MG0311A $\pi/4$ DQPSK Modulation Unit	
IS-95	MG0310A CDMA Modulation Unit*1	
	MG0312A QPSK Modulation Unit	

*1 MG3670B, MG3671A: Requires Option 25

Features

- Compatible with communication system measurement signals of Japan, North America and Europe
- High modulation accuracy ($\leq 1.8\%$ rms vector error)
- Outputs modulation signals suited to each communication system
- Internal pattern generator with data-editing and scrambling functions
- Outputs IS-95 channel multiplex signal
- Wide range (30 MHz, 3 dB) I/Q Input (only for MG3672A)

Basic performance

- I/Q input supporting wide range of applications (only for MG3672A)

The MG3672A is equipped with wide-band I/Q input from DC to 30 MHz (3 dB) so that wide-band quadrature modulation can be performed. This ensures that the MG3672A will remain fully compatible with communication systems for which band expansion is planned in the future.

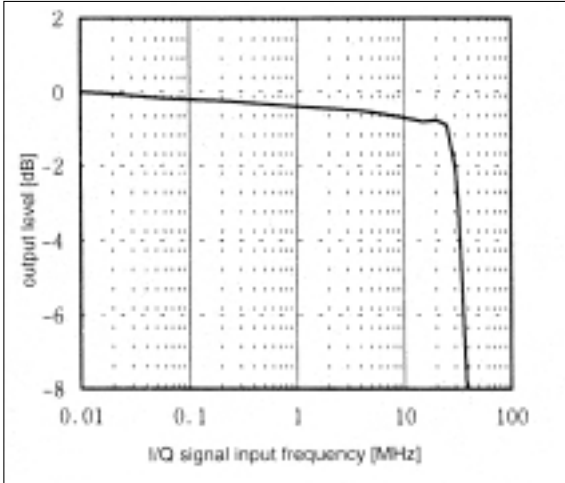

Frequency response for I/Q external modulation (typical values)

- I/Q signal I/O over broad frequency range (only for MG3670B/C, MG3671A/B)

A quadrature modulator is built in, and external I/Q signals can be input to enable use with a variety of digital modulation modes, including QPSK, 8PSK, and M16QAM. The modulation band for I/Q input signals is broad, covering the CDMA spread spectrum bandwidth. Further, by adding an expansion unit, I/Q signal output can be obtained from the internal data generator. Either 50 Ω or CMOS-level compatibility can be selected for I/Q signals. Functions for adjusting the level balance, offset, and phase are also provided for greater utility in evaluating modulators/demodulators and other devices.

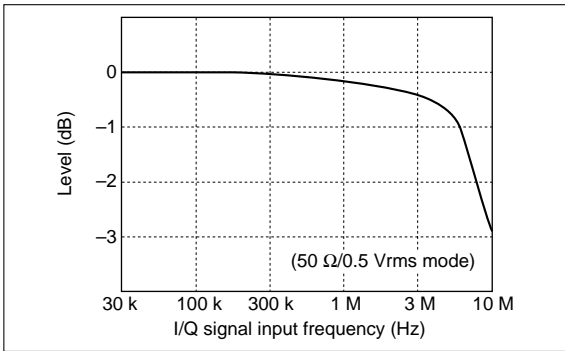

Frequency response for I/Q external modulation (typical values)

- Excellent spectral purity

The SSB phase noise characteristic is an excellent -120 dBc/Hz or less (100 kHz offset). The adjacent channel power characteristic excels as the interference signal source during modulation.

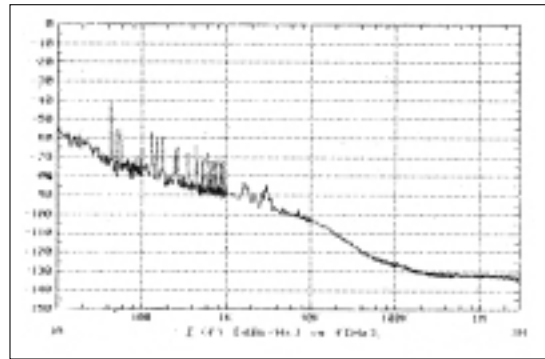

SSB phase noise at 1.9 GHz

- Large output level

Through use of new AGC circuitry, the MG3670B/C, MG3671A/B, and MG3672A produce a highly precise output at levels down to -143 dBm with stable frequency characteristics, not only for output of unmodulated signals but also with $\pi/4$ DQPSK modulation accompanied by amplitude fluctuations and when outputting burst signals. The MG3670B/C, MG3671A/B and MG3672A can generate a high output level of up to +13 dBm over a broad range of frequencies, so amplifiers are not needed even when testing receivers for excess input and in testing other devices.

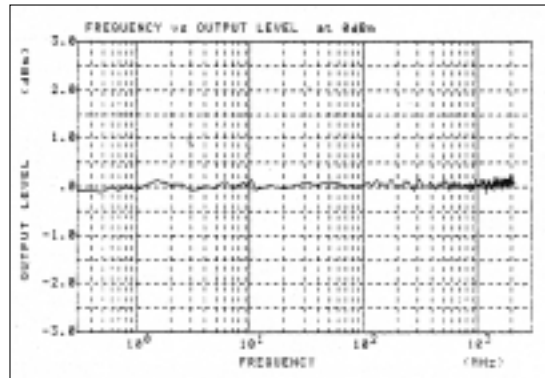

Output level frequency characteristics

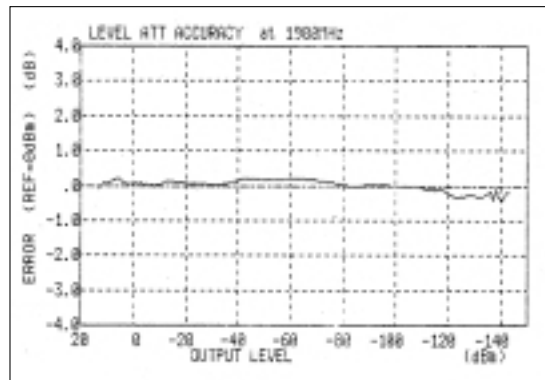

Output level accuracy at 1.9 GHz

- High modulation accuracy

A vector error of less than 1.8%rms is assured for output levels up to +5 dBm over the entire operating frequency range. This high modulation accuracy is also achieved when the expansion units are used. Even when the MG0301C and MG0303B units are installed and $\pi/4$ DQPSK modulation burst signals are generated, the vector error is less than 1.8%rms. The MG3670B/C, MG3671A/B and MG3672A enable measurement and quality evaluation of receivers and other devices with more than adequate precision.

Functions and performances with expansion unit

• Frame structure and data

TDMA

The MG0303B incorporates TDMA frames for various kinds of communication systems, as well as modulation patterns for each time slot. Modulation patterns for device evaluation and for up/down communication channels are provided and are output at the timing required by the system. Hence the MG3670B/C, MG3671A/B, and MG3672A can generate the burst signals needed to measure various digital communication systems.

Time slots specified for different communication systems can be selected freely. There is considerable freedom in choosing the modulation pattern within slots; either a PN9 or PN15 TCH segment can be chosen, and part of the data outside the TCH segment can be edited. The pattern memory function can be used to store and recall patterns. A data scrambling function is provided as standard, and any initial code can be set permitting more sophisticated evaluations and diagnostics using the MG3670B/C, MG3671A/B and MG3672A as a supposed base station and mobile equipment.

The internal modulation pattern can also be driven by an external clock, so margin tests can be conducted by varying the clock pulse.

• Excellent leakage power characteristics during carrier-off

The rising and falling edges of burst signals have a gentle waveform with a duration equivalent to two symbols, and the leakage power during carrier-off characteristics are excellent.

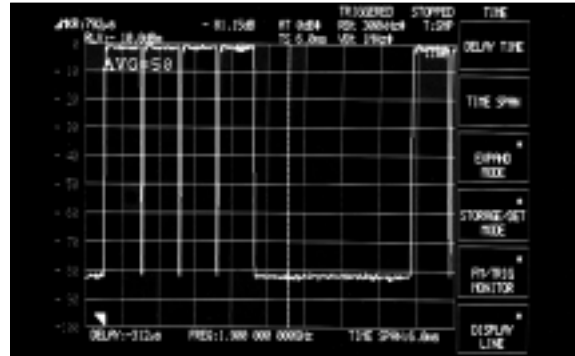

PHS



Pattern edit display

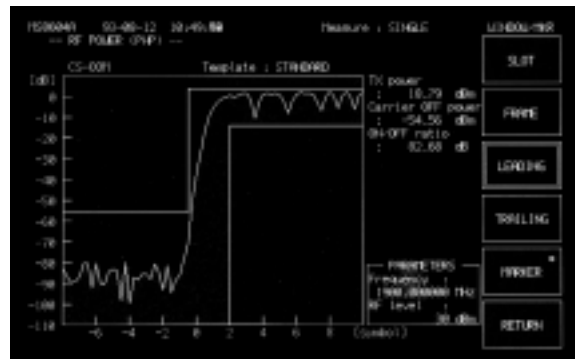

Slot rise time waveform

CDMA

MG0310A has various TIA/EIA/IS-95 frame formats and encoder functions built-in for each channel type. For example, frame format of signalling, communication, and Multiplex Option 1 are provided to support Rate Set 1 (1200 ... 9600 bps) and Rate Set 2 (1800 ... 14400 bps) for the Traffic Channel. In combination with the Burst Randomizer function, this allows system support at all rates, even for reverse links. For internal data you can select either a PN7, 9, or 15 pseudo-random pattern, or a user settable 16-bit data repeating pattern, all fully editable. Operation can be from internal RAM user-definable sequence data or from external serial data.

• Superior spurious emission characteristics

Spurious emissions are guaranteed to be lower than -60 dBc (±900 kHz detuning, 30 kHz bandwidth) and -70 dBc (±1.98 MHz detuning, 30 kHz bandwidth) with MG0310A installed in the MG3670C/3671B/3672A mainframe (for output level: 0 dBm, baseband filter: SPEC 2). Using this baseband filter gives a waveform quality factor (p) of 0.999 or better. This filter conforms to IS-95, providing 3-step switching. Selecting the best step for each evaluation item gives even higher performance. This excellent basic performance in a standard digital modulation signal generator makes it the ideal choice for the development and manufacture of digital mobile wireless equipment and related devices/modules.

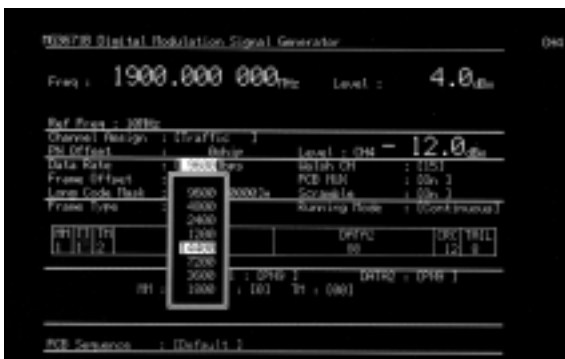

Pattern setting display

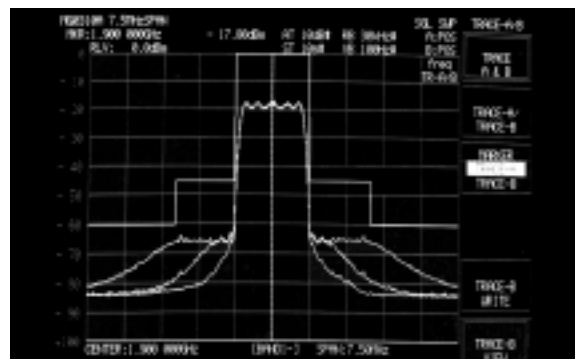

Modulation spectrum (with MG0310A installed in the MG3670C/3671B/3672A)

Specifications (refer to the MG3670B/C, MG3671A/B, and MG3672A data sheet for more details)

• MG3670B/C, MG3671A/B, and MG3672A Digital Modulation Signal Generator

Carrier frequency	Frequency range	300 kHz to 2250 MHz (MG3670B/C), 300 kHz to 2750 MHz (MG3671A/B and MG3672A)		
	Accuracy	Depends on installed reference oscillator*1		
	Internal reference oscillator	Frequency: 10 MHz Start-up characteristics: $\leq 1 \times 10^{-7}$ /day (after 30 min. warm-up), $\leq 5 \times 10^{-8}$ /day (after 60 min. warm-up) Aging rate: $\leq 2 \times 10^{-8}$ /day (after 24 h warm-up) Temperature characteristics: $\leq \pm 5 \times 10^{-8}$ (0° to 50°C)		
	External reference input	10 MHz or 13 MHz (± 10 ppm), 2 to 5 Vp-p, BNC connector (rear panel)		
Output	Reference output	10 MHz, 2 to 5 Vp-p, BNC connector (rear panel)		
	Level range*2	-143 to +13 dBm (resolution: 0.1 dB)		
	Frequency response	$\leq \pm 1$ dB (at 0 dBm output)		
	Level accuracy*2	Output level/frequency	≤ 1000 MHz	> 1000 MHz
		-33 to +13 dBm	± 1 dB	± 2 dB
		-123 to -33.1 dBm	± 1.5 dB	± 2 dB
		-136 to -123.1 dBm	± 3 dB	± 4 dB
	Impedance	50 Ω , N-type connector		
Continuously variable level*2	Continuously variable output over 20 dB range (+8 to -12 dB) in 0.1 dB steps within upper and lower limits of any output level			
Level unit	dBm, dB μ , μ V, mV, V (dB μ , μ V, mV, V selected terminate/open voltage display)			
Interference radiation	≤ 1 μ V *Measured 25 mm from cabinet (except rear panel) with two-turn 25 mm diameter loop antenna, terminated with 50 Ω load, $\leq +5$ dBm output, CW			
Signal purity	Spurious (at $\leq +5$ dBm output)	≤ -65 dBc (≥ 100 kHz offset, $\leq \pm 100$ MHz bandwidth), ≤ -50 dBc (≥ 100 kHz offset, full band), ≤ -40 dBc [≥ 2.65 GHz, spurious at 5.4-Fout (carrier frequency) GHz], ≤ -30 dBc (harmonics)		
	SSB phase noise	≤ -120 dBc/Hz (100 kHz offset, CW)		
Digital modulation	Internal modulation	Depends on installed modulation unit (MG0301C/0302A/0305A/0307A/0310A/0311A/0312A)		
	External modulation	For MG3670B/C, MG3671A/B Any modulation using I/Q input signal Input frequency: DC to 1.2 MHz*3 Input level: $\sqrt{I^2 \pm Q^2} \leq 0.5$ Vrms, BNC connector *I/Q ≤ 1.5 Vp-p (50 Ω), I/Q $\leq 10\%$ to 100% of 1.5 Vp-p (CMOS) Vector error: $\leq 1.8\%$ rms (I/Q input level: 1 Vrms/50 Ω , at $\leq +5$ dBm output)		
		For MG3672A 50 Ω input Input frequency: DC to 30 MHz (BW: 3 dB, 18° to 30°C), Input level: $\sqrt{I^2 \pm Q^2} \leq 1.0$ Vrms, I/Q ≤ 1.5 Vp-p CMOS input Input frequency: DC to 1.2 MHz, Input level: $\sqrt{I^2 \pm Q^2} \leq 1.0$ Vrms, I/Q ≤ 1.5 Vp-p		
	I/Q output	Outputs I/Q signal at internal modulation (MG0301C/0302A/0305A/0307A/0310A/0311A/0312A installed)		
Pulse modulation	Input	TTL level, BNC connector, polarity selectable		
	On/off ratio	≥ 40 dB (at ≥ 0 dBm output)		
	Transition time	≤ 2 μ s, minimum pulse width: 10 μ s		
Memory function	Frequency memory	1000 carrier frequencies (save and recall)		
	Parameter memory	100 panel settings (save and recall)		
Other functions	Relative display	Carrier frequency, output level		
	I/Q signal adjustment	Variable offset, balance, phase (only output) of I/Q input/output signal (DC to 1.2 MHz)		
	Backup	Last settings stored at power-off		
	Reverse power protection	Maximum reverse input power: 50 W (<1000 MHz), 25 W (≥ 1000 MHz), ± 50 Vdc		
Operating temperature	All functions except power switch and panel lock switch controlled Interface function: SH1, AH1, T6, L4, SR1, RL1, PP0, DC1, DT0, C0, E2			
	0° to 50°C			
Power	100 to 120/200 to 240 Vac (switchable), 47.5 to 63 Hz, ≤ 550 VA			
Dimensions and mass	(426 \pm 5) W x (221.5 \pm 4) H x (451 \pm 5) D mm, ≤ 27 kg			

*1: Internal reference oscillator accuracy: 2×10^{-8} /day (23° \pm 5°C), calibrated after 24 h operation

*2: Depended on the specifications of each units when MG0310A unit are installed.

*3: Refer to the "Frequency response for I/Q external modulation (typical value)" on page 217 for the input frequency range. Typical values are given for reference only to assist in the use of this instrument, and are not guaranteed specifications.

• **MG0301C $\pi/4$ DQPSK Modulation Unit (incorporated in the MG3670B/C, MG3671A/B and MG3672A)**

Applicable communication system	PDC, PDC_H, PHS, NADC, TFTS
Modulation system	$\pi/4$ DQPSK
Vector error	I/Q signal: $\leq 1.5\%$ rms (at 50 Ω output), RF signal: $\leq 1.8\%$ rms (at $\leq +5$ dBm output)
Internal modulation data	Pseudorandom pattern: PN15, PN9 Free 4-bit repetition pattern (ex: 1010, 1111)
External modulation data	DATA CLOCK: Covering $\pm 5\%$ of bit rate DATA: Digital data synchronized with DATA CLOCK SYMBOL CLOCK: Clock specified by DATA synchronized with DATA CLOCK TTL level, BNC connector, polarity selectable
I/Q signal output	Selectable 50 Ω or CMOS (600 Ω), BNC connector 50 Ω setting [modulation data: 0000 (TFTS: 1111)]: 1 Vp-p $\pm 2\%$ (MG3670A/B/C, MG3671A/B), 2 Vp-p $\pm 2\%$ (MG3672A) CMOS setting [modulation data: 0000 (TFTS: 1111)] Variable in 10% steps over range of 10% to 100% of 1 Vp-p $\pm 2\%$, variable offset voltage: 0 to 4 V in 1 mV steps (MG3670A/B/C, MG3671A/B) Variable in 10% steps over range of 10% to 100% of 2 Vp-p $\pm 2\%$, variable offset voltage: 0 to 4 V in 1 mV steps (MG3672A)
PDC, PDC_H	Carrier frequency range: 300 kHz to 2250 MHz*1 (incorporated in the MG3670B/C), 300 kHz to 2750 MHz (incorporated in the MG3671A/B and MG3672A) Bit rate: 42 kbps Baseband filter: Root Nyquist ($\alpha = 0.5$), Nyquist ($\alpha = 0.5$)
PHS	Carrier frequency range: 1 to 2250 MHz*1 (incorporated in the MG3670B/C), 1 to 2750 MHz (incorporated in the MG3671A/B and MG3672A) Bit rate: 384 kbps Baseband filter: Root Nyquist ($\alpha = 0.5$), Nyquist ($\alpha = 0.5$) Adjacent channel power ratio: ≤ -74 dB (600/900 kHz offset, ± 96 kHz band, ≥ 10 MHz)*2
NADC	Carrier frequency range: 300 kHz to 2250 MHz*1 (incorporated in the MG3670B/C), 300 kHz to 2750 MHz (incorporated in the MG3671A/B and MG3672A) Bit rate: 48.6 kbps Baseband filter: Root Nyquist ($\alpha = 0.35$), Nyquist ($\alpha = 0.35$)
TFTS	Carrier frequency range: 300 kHz to 2250 MHz*1 (incorporated in the MG3670B/C), 300 kHz to 2750 MHz (incorporated in the MG3671A/B and MG3672A) Bit rate: 44.2 kbps Baseband filter: Root Nyquist ($\alpha = 0.4$), Nyquist ($\alpha = 0.4$)

*1: The upper frequency is limited by the specifications of the main frame in which this unit is installed.

*2: Applicable when this unit is installed in MG3670B/C, MG3671A/B and MG3672A. Not applicable when this unit is installed in MG3670A.

• **MG0302A GMSK Modulation Unit (incorporated in the MG3670B/C, MG3671A/B and MG3672A)**

Applicable communication system	GSM, DCS1800 (PCN), CT2
Modulation system	GMSK
Phase error	I/Q signal: $\leq 1^\circ$ rms, $\leq 3^\circ$ peak (at 1 Vrms/50 Ω output, 25° $\pm 5^\circ$ C, after 30 min. warm-up) $\leq 2^\circ$ rms, $\leq 5^\circ$ peak (at 1 Vrms/50 Ω output) RF signal: $\leq 1^\circ$ rms, $\leq 3^\circ$ peak (at $\leq +5$ dBm output, 25° $\pm 5^\circ$ C, after 30 min. warm-up) $\leq 2^\circ$ rms, $\leq 5^\circ$ peak (at $\leq +5$ dBm output)
Internal modulation data	Pseudorandom pattern: PN15, PN9, free 4-bit repetition pattern (ex: 1010, 1111)
External modulation data	DATA CLOCK: Covering $\pm 5\%$ of bit rate, DATA: Digital data synchronized with DATA CLOCK *TTL level, BNC connector, polarity selectable
I/Q signal output	Selectable 50 Ω or CMOS (600 Ω), BNC connector 50 Ω setting (modulation data: 0000): 1 Vp-p $\pm 2\%$ (MG3670A/B/C, MG3671A/B), 2 Vp-p $\pm 2\%$ (MG3672A) CMOS setting (modulation data: 0000) Variable in 10% steps over range of 10% to 100% of 1 Vp-p $\pm 2\%$, variable offset voltage: 0 to 4 V in 1 mV steps (MG3670A/B/C, MG3671A/B), Variable in 10% steps over range of 10% to 100% of 2 Vp-p $\pm 2\%$, variable offset voltage: 0 to 4 V in 1 mV steps (MG3672A)
GSM/PCN (DCS1800)	Carrier wave frequency range: 1 to 2250 MHz*1 (incorporated in the MG3670B/C), 1 to 2750 MHz (incorporated in the MG3671A/B and MG3672A) Bit rate: 270.833 kbps Baseband filter: Gaussian filter BbT = 0.3
CT2	Carrier wave frequency range: 300 kHz to 2250 MHz*1 (incorporated in the MG3670B/C), 300 kHz to 2750 MHz (incorporated in the MG3671A/B and MG3672A) Bit rate: 72 kbps Baseband filter: Gaussian filter BbT = 0.5

*1: The upper frequency is limited by the specifications of the mainframe in which this unit is installed.

• **MG0305A GFSK Modulation Unit (incorporated in the MG3670B/C, MG3671A/B and MG3672A)**

Applicable communication system	DECT
Modulation system	GFSK
Vector error	I/Q signal: ≤ 12 kHz (at 1 Vrms/50 Ω output), RF signal: ≤ 12 kHz (at $\leq +5$ dBm output, modulation data: FFFF)
Internal modulation data	Pseudo-random pattern: PN15/PN9, Free 16-bit repetition pattern (ex: 0F0F, 00FF)
External modulation data	DATA CLOCK: Covering $\pm 5\%$ of bit rate, DATA: Digital data synchronized with DATA CLOCK *TTL level, BNC connector, polarity selectable
I/Q signal output	Selectable 50 Ω or CMOS (600 Ω), BNC connector 50 Ω setting (modulation data: 0000): 1 Vp-p $\pm 6\%$ (MG3670A/B/C, MG3671A/B), 2 Vp-p $\pm 6\%$ (MG3672A) CMOS setting (modulation data: 0000) Variable in 10% steps over range of 10% to 100% of 1 Vp-p $\pm 6\%$, variable offset voltage: 0 to 4 V in 1 mV steps (MG3670A/B/C, MG3671A/B), Variable in 10% steps over range of 10% to 100% of 2 Vp-p $\pm 6\%$, variable offset voltage: 0 to 4 V in 1 mV steps (MG3672A)
Phase polarity	Polarity reversal of frequency deviation during modulation is possible.
DECT	Carrier frequency range: 5 to 2250 MHz*1 (incorporated in the MG3670B/C), 5 to 2750 MHz (incorporated in the MG3671A/B and MG3672A) Bit rate: 1152 kbps Deviation ratio: 70% (202 kHz), 90% (259 kHz), 100% (288 kHz), 140% (403 kHz), at BbT=0.5 Baseband filter: Gaussian filter BbT = 0.4, 0.5, 0.6, at deviation ratio = 100%

*1: The upper frequency is limited by the specifications of the mainframe in which this unit is installed.

• **MG0307A $\pi/4$ DQPSK Modulation Unit (incorporated in the MG3670B/C, MG3671A/B and MG3672A)**

Applicable communication system	PACS, WCPE, PHS
Modulation system	$\pi/4$ DQPSK
Vector error	I/Q signal: $\leq 1.5\%$ rms (at 1 Vrms/50 Ω output), RF signal: $\leq 1.8\%$ rms (at $\leq +5$ dBm output)
Internal data mode	Pseudo-random pattern: PN15, PN9 Free 16-bit repetition pattern (ex: 0F0F, 00FF): WCPE Free 4-bit repetition pattern (ex: 0101, 0011): PACS, PHS
External data mode	DATA CLOCK: Covering $\pm 5\%$ of bit rate DATA: Digital data synchronized with DATA CLOCK SYMBOL CLOCK: Clock specified by DATA synchronized with DATA CLOCK TTL level, BNC connector, polarity selectable
I/Q signal output	Selectable 50 Ω or CMOS (600 Ω), BNC connector 50 Ω setting (modulation data: 0000): 1 Vp-p $\pm 5\%$ (MG3670A/B/C, MG3671A/B), 2 Vp-p $\pm 5\%$ (MG3672A) CMOS setting (modulation data: 0000) Variable in 10% steps over range of 10% to 100% of 1 Vp-p $\pm 5\%$, variable offset voltage: 0 to 4 V in 1 mV steps (MG3670A/B/C, MG3671A/B), Variable in 10% steps over range of 10% to 100% of 2 Vp-p $\pm 5\%$, variable offset voltage: 0 to 4 V in 1 mV steps (MG3672A)
Phase encode function	Invertible phase polarity at modulation
PACS	Carrier frequency range: 1 to 2250 MHz*1 (incorporated in the MG3670B/C), 1 to 2750 MHz (incorporated in the MG3671A/B and MG3672A) Bit rate: 384 kbps Baseband filter: Root Nyquist ($\alpha = 0.5$), Nyquist ($\alpha = 0.5$)
WCPE	Carrier frequency range: 5 to 2250 MHz*1 (incorporated in the MG3670B/C), 5 to 2750 MHz (incorporated in the MG3671A/B and MG3672A) Bit rate: 1152 kbps Baseband filter: Root Nyquist ($\alpha = 0.5$), Nyquist ($\alpha = 0.5$)
PHS	Carrier frequency range: 1 to 2250 MHz*1 (incorporated in the MG3670B/C), 1 to 2750 MHz (incorporated in the MG3671A/B and MG3672A) Bit rate: 384 kbps Baseband filter: Root Nyquist ($\alpha = 0.5$), Nyquist ($\alpha = 0.5$) Adjacent channel power ratio: ≤ -74 dB (600/900 kHz offset, ± 96 kHz band, ≥ 10 MHz)*2

*1: The upper frequency is limited by the specifications of the mainframe in which this unit is installed.

*2: Applicable when this unit is installed in MG3670B/C, MG3671A/B and MG3672A. Not applicable when this unit is installed in MG3670A.

• **MG0311A $\pi/4$ DQPSK Modulation Unit (incorporated in MG3670B/C, MG3671A/B and MG3672A)**

Applicable communication system	TETRA
Modulation system	$\pi/4$ DQPSK
Vector error	I/Q signal: $\leq 1.5\%$ rms (at 50 Ω output); RF signal: $\leq 1.8\%$ rms (at $\leq +5$ dBm output)
Internal modulation data	Pseudo-random pattern: PN15/PN9, Free 4-bit repetition pattern (ex: 0101, 0011)
External modulation data	DATA CLOCK: Covering $\pm 5\%$ of bit rate DATA: Digital data synchronized with DATA CLOCK SYMBOL CLOCK: Clock specified by DATA synchronized with DATA CLOCK *TTL level, BNC connector, polarity selectable
I/Q signal output	Selectable 50 Ω or CMOS (600 Ω), BNC connector 50 Ω setting (modulation data: 0000): 1 Vp-p $\pm 5\%$ (MG3670A/B/C, MG3671A/B), 2 Vp-p $\pm 5\%$ (MG3672A) CMOS setting (modulation data: 0000) Variable in 10% steps over range of 10% to 100% of 1 Vp-p $\pm 5\%$, variable offset voltage: 0 to 4 V in 1 mV steps (MG3670A/B/C, MG3671A/B), Variable in 10% steps over range of 10% to 100% of 2 Vp-p $\pm 5\%$, variable offset voltage: 0 to 4 V in 1 mV steps (MG3672A)
Phase encode function	Invertible phase change polarity at modulation
TETRA	Carrier frequency range: 300 kHz to 2250 MHz*1 (incorporated in MG3670B/C), 300 kHz to 2750 MHz (incorporated in MG3671A/B and MG3672A) Bit rate: 36 kbps Baseband filter: Root Nyquist ($\alpha = 0.35$), Nyquist ($\alpha = 0.35$) Adjacent channel leakage power ratio*2: ≤ -48 dB (25 kHz offset, ± 9 kHz band), ≤ -67 dB (50 kHz offset, ± 9 kHz band)

*1: The upper frequency is limited by the specifications of the mainframe in which this unit is installed.

*2: Also applicable when this unit is installed in the MG3670A with option 11 (low adjustment channel leakage power). This unit can not be installed in the MG3670A without option 11.

• **MG0303B Burst Function Unit (incorporated in the MG3670B/C, MG3671A/B and MG3672A)**

Applicable communication system	PDC, PDC_H, PHS, NADC, TFTS (with MG0301C) GSM, PCN (DCS1800), CT2 (with MG0302A) DECT (with MG0305A) PACS, WCPE, PHS (with MG0307A) TETRA (with MG0311A)	
Modulation signal	Internal data mode	TDMA framing specified for each system; modulation in each time slot using any internal modulation data
	Internal data	Pseudo-random pattern: PN15/PN9*1 (for device) Specified pattern based on communication channel format specified for each system: Up/down communication channel, VOX signal control TCH section consists of pseudo-random pattern PN15/PN9*1
	External data mode	DATA CLOCK: Covering $\pm 5\%$ of bit rate DATA: Digital data synchronized with DATA CLOCK SYMBOL CLOCK: Clock specified by DATA synchronized with DATA CLOCK BURST GATE: Burst signal synchronized with DATA CLOCK (on: ≥ 14 symbols, off: ≥ 8 symbols) TTL level, BNC connector, polarity selectable
Burst trigger input	Burst wave output synchronized with trigger input signal of burst repetition rate (frame cycle) at internal modulation Input period: \leq burst repetition rate ± 1 symbol [PDC, PDC_H, PHS, NADC, GSM, PCN (DCS1800), CT2, DECT, PACS, WCPE, TETRA], \leq burst repetition rate $\pm 1/2$ symbol (TFTS) TTL level, BNC connector (rear panel), polarity selectable	
Control signal output	Burst trigger output	Outputs 1-symbol wide pulse at same cycle as burst waveform output at internal modulation TTL level, BNC connector (rear panel), polarity selectable
	Pattern sync output	Following outputs selectable at internal modulation PN CLOCK: Data clock corresponding to pseudo-random pattern part PN GATE: Gate signal corresponding to pseudo-random pattern part RF GATE: Signal for controlling pulse modulator in accordance with burst signal output TTL level, BNC connector (rear panel)
	Burst gate output	Outputs gate signal corresponding to burst waveform output at internal modulation TTL level, BNC connector (rear panel), polarity selectable
RF output	Burst on/off ratio	≥ 80 dB (+5 dBm output, PDC, PDC_H, NADC, CT2, TFTS, TETRA), ≥ 75 dB (+5 dBm output, PHS, GSM, PCN, PACS), ≥ 70 dB (+5 dBm output, DECT, WCPE)
	Rise/fall time	Equivalent to 2 symbols
Memory (pattern memory)	Max. 100 patterns/system (save and recall of internal modulation pattern data)	
NADC	Burst repetition rate	20 ms
	Slot configuration	For device, up/down communication channel
	Output slot select	On/off selectable for any slots of slot 0 to slot 2 (excluding all slots off)
	Edit function	SYNC/SACCH/CDVCC: Any data, DATA: PN9, PN15*1 selectable

Continued on next page

PDC PDC_H	Burst repetition rate	20 ms (PPC), 40 ms (PDC_H)
	Slot configuration	For device, up/down communication channel, up VOX control
	Output slot select	On/off selectable for any slots of slot 0 to slot 2 (PDC)/slot 5 (PDC_H) *excluding all slots off
	Edit function	SW/CC/SACCH: Any data, TCH: PN9, PN15*1 selectable
	Scramble function	TCH + SF + SACCH scramble on/off, any scramble code setting
PHS	Burst repetition rate	5 ms
	Slot configuration	For device, up/down communication channel, VOX control
	Output slot select	On/off selectable for any slots of slot 1 to slot 4 (excluding all slots off)
	Edit function	UW/SA: Any data, TCH: PN9, PN15*1 selectable
	Scramble function	TCH + CRC, scramble and secret scramble on/off, any scramble code setting
	Adjacent channel power leakage ratio	≤-74 dB (600/900 kHz offset, ±96 kHz band, ≥10 MHz)*2
TFTS	Burst repetition rate	80 ms
	Slot configuration	For device, up/down communication channel
	Output slot select	On/off selectable for any slots of slot 0 to slot 16 (Device/UP TCH: Slots 16 is off at all time, excluding all slots off)
	Edit function	S: Any data, DATA: PN9, PN15*1 selectable
GSM, PCN (DCS1800)	Burst repetition rate	4.615 ms
	Slot configuration	For device, normal burst (communication channel)
	Output slot select	On/off selectable for any slots of slot 0 to slot 7 (excluding all slots off)
	Edit function	TS: Any data, E: PN9, PN15*1 selectable
CT2	Burst repetition rate	2 ms
	Slot configuration	Up/down communication channel (MUX 1.2, MUX 1.4, MUX 2)
	Edit function	D, B, Da, Db, CHM/SYNC data selectable
	Scramble function	B scramble on/off, any scramble code setting
DECT	Burst repetition rate	10 ms
	Slot configuration	For device, up/down communication channel
	Output slot select	Full slot: Slot 0 to slot 11 (down channel), slot 12 to slot 23 (up channel) Half slot: Slot 0-0 to slot 11-1 (down channel), slot 12-0 to slot 23-1 (up channel) Double slot: Slot 0 to slot 10 (down channel), slot 12 to slot 22 (up channel) *On/off selectable for any slots (excluding all slots off)
	Edit function	S, H, T: Any data D: PN15/PN9*1, all-0 or all-1 selectable (for device evaluation) D: PN15/PN9*1, TEST or REP-8 bits any data selectable (for communication channel)
PACS	Burst repetition rate	2.5 ms
	Slot configuration	For device, up/down communication channel
	Output slot select	On/off selectable for any slots of slot 0 to slot 7 (excluding all slots off)
	Edit function	PN: PN9, PN15*1 selectable (for device), DE/SC/R/SYC/PCC: Any data, FC: PN9*1, PN15*1, all-0 or all-1 selectable (PN15 selectable only for 1 slot)
WCPE	Burst repetition rate	10 ms
	Slot configuration	For device, up/down communication channel
	Output slot select	Full slot: Slot 0 to slot 11 (down), slot 12 to slot 23 (up); Half slot: Slot 0-0 to slot 11-1 (down), slot 12-0 to slot 23-1 (up); Double slot: Slot 0 to slot 10 (down), slot 12 to slot 22 (up) *On/off selectable for any slots (excluding all slots off)
	Edit function	S/H/T: Any data D: PN9*1, PN15*1, all-0 or all-1 selectable (for device) D: PN9*1, PN15*1, TEST or REP 8-bits any data selectable (for communication channel)
PHS	Burst repetition rate	5 ms
	Slot configuration	For device, up/down communication channel, VOX control, sync burst
	Output slot select	On/off selectable for any slots of slot 1 to slot 4 (excluding all slots off)
	Edit function	UW/SA etc.: Any data, TCH: PN9, PN15*1 selectable
	Scramble function	TCH + CRC, scramble on/off, any scramble code setting
	Adjacent channel power leakage ratio	≤-74 dB (600/900 kHz offset, ±96 kHz band, ≥10 MHz)*2
TETRA	Burst repetition rate	V + D mode: 1.02; Excluding CH13, 255 to 30000 symbols; CH13 PDO mode: 1.00; Excluding CH14, 126 to 30000 symbols; CH14
	Burst pattern	Following channel types selectable V + D mode: CH1, CH2, CH3, CH4, CH13; Downlink, CH7, CH8, CH9, CH10, CH11; Uplink PDO mode: CH5, CH6, CH14; Downlink, CH12; Uplink
	Slot configuration	V + D mode: DEVICE, NORMAL, SYNC; Downlink, DEVICE NORMAL, CONTROL; Uplink PDO mode: NORMAL, SYNC; Downlink, START, EVEN, ODD, END; Uplink
	Output slot select	V + D mode: On/off selectable for any slots of slot 1 to slot 4 (excluding CH13 and all slots off) Frame 1 to Frame 17 set to the same values PDO mode: Variable slot numbers of slot 1 to slot 150 (excluding CH14)

Continued on next page

TETRA	Edit function	V + D mode: Downlink NORMAL; Any SB, SSB, NTS field data SYNC; Any FC, SSB1, STS, SBB, SB2 field data Uplink NORMAL; Any SB, NTS field data CONTROL; Any SCB, ETS field data PDO mode: Downlink SYNC; Any FC, SB, STS field data NORMAL; Any SB, NTS field data Uplink START; Any ETS, SB field data, R bit Length EVEN; Any NTS field data
	Scramble function	Any scramble code setting

*1: The pseudorandom pattern in each slot has a different phase, and its pattern is continuous within the data field of slots.
 *2: Applicable when this unit is installed in MG3670B/C, MG3671A/B, and MG3672A. Not applicable when this unit is installed in MG3670A.

• **MG0310A CDMA Modulation Unit (incorporated in the MG3670B/C, MG3671A/B and MG3672A)*1**

Carrier frequency range	4 kHz to 2250 MHz (MG3670B/C), 4 kHz to 2750 MHz (MG3671A/B and MG3672A)	
RF output level	-143 to +8 dBm, 0.1 dB steps (1 channel only on, PCB MUX must be off when traffic present) -143 to +4 dBm, 0.1 dB steps (multiplex channel) Frequency response, level accuracy: Depends on main frame (after level calibration)	
Supported systems	IS-95: US Digital Cellular System	
Modulation format	Forward link: SS + QPSK; Reverse link: SS + OQPSK	
Chip rate	1.2288 Mcps	
Baseband filters	IS-95 recommended filters: SPEC 1, SPEC 2, SPEC 3, SPEC 1 + EQ, SPEC 2 + EQ, SPEC 3 + EQ Nyquist filters: $\alpha = 0.2, 0.25, 0.3, 0.35, 0.4, 0.45, 0.5$ Root Nyquist filters: $\alpha = 0.2, 0.25, 0.3, 0.35, 0.4, 0.45, 0.5$	
Forward link	Multiplex channels	Channels 1 to 5
	Supported channels	CH 1: Current Pilot, Off CH 2 to CH 5: Nth Pilot, Sync, Paging, Traffic, OCNS, Off (Sync available for 1 selected channel only, all channels cannot be turned off simultaneously.)
	Spread code	Walsh code + Short code
	Walsh code	Point: 0, Sync: 32, Paging: 1 to 7, Traffic: 8 to 31/33 to 63, OCNS: 0 to 63 (Except for Pilot code, same code number cannot be set for multiple channels.)
	Short code offset	0 to 3276 chips in 64 chip steps (for Current Pilot), 1 chip steps (for Nth Pilot)
	Data rate	Sync 1200 bps, Paging: 4800/9600 bps, OCNS: 19200 sps, Traffic: 1200/2400/4800/9600 bps, 1800/3600/7200/14400 bps (Single channel selection only, except for 9600/14400 bps)
	Channel level	(RF output level + upper limit for each no. of multiplex channels) to -20 dB in 0.1 dB steps Upper limit for each no. of multiplex channels: -3 dB (2 channels), -5 dB (3 channels), -6 dB (4 channels), -7 dB (5 channels) *Level is set automatically for channel with highest CH number, user setting not possible.
	Scramble function	Long code scramble on/off (for Paging/Traffic/OCNS)
	PCB MUX function	Power control bit transmission on/off (for Traffic) PCB data: Selectable 256 bit data repeating pattern
	Long code mask	42 bits can be set by user in each channel (scramble On, PCB MUX On)
Reverse link	Multiplex channels	Channels 1 to 4
	Supported channels	CH 1: Traffic, Access, Interfered CH 2 to CH 4: Traffic, Access, Interfered, Off
	Spread code	Long code + short code
	Long code mask	42 bits can be set by user in each channel.
	Data rates	Access: 4800 bps, Interfered: 28800 sps Traffic: 1200/2400/4800/9600 bps, 1800/3600/7200/14400 bps (For CH1 only on, except for 9600/14400 bps)
	Channel level	(RF output level + upper limit for each no. of multiplex channels) to -15 dB in 0.1 dB steps, Upper limit for each No. of multiplex channels: 0 dB (2 channels), 2 dB (3 channels), -3 dB (4 channels) CH 1 is fixed on upper limit, user setting not possible.
	Power monitor function	CH 1 to CH 4 composite output level, CH 2 to CH 4 composite output level (N), S/N ratio of CH 1 output level (S), CH 1 Eb/N (Multiplex channel only)
Frame offset	0 to 15 power control group (PCG) in 1 PCG steps	
Internal frame structure	Frame formats for all channel types specified by IS-95	
Internal modulation data	Pseudo-random patterns: PN7, PN9, PN15 Fixed pattern: User settable 16 bit data repeating pattern Sequence data: User can set sequence data in internal RAM (2048 bits x 7 blocks) as repeating pattern of 1 to 8192 frames.	
External modulation data	Using internal time reference clock Data Clock: Data rate clock synched to Ref Clock and Frame Clock Data: Digital data synched to Data Clock ESTM Clock: 0.5 pulse/s clock synched to Ref Clock and Data Clock Frame Clock: Channel frame clock synched to Ref Clock and ESTM Clock BNC connector, TTL level, polarity switchable Using external time reference clock Ref Clock: $\pm 2\%$ of 19.6608, 9.8304, 4.9152, 2.4576 or 1.2288 MHz Data: Digital data synched to Data Clock ESTM Clock: 0.5 pulse/s clock synched to Ref Clock and Data Clock Frame Clock: Channel frame clock synched to Ref Clock and ESTM Clock BNC connector, TTL level, polarity switchable	
I/Q signal output	50 Ω or CMOS (600 Ω), BNC connector	

Continued on next page

Modulation accuracy (VEM), Waveform quality (ρ)	≤ 0 dBm output, CH1 only on, level control program function Off VEM $\leq 2.5\%$ rms, $\rho \leq 0.9992$ (With SPEC 1 baseband filter) VEM $\leq 3.5\%$ rms, $\rho \leq 0.999$ (With SPEC 2 baseband filter) VEM $\leq 9.7\%$ rms, $\rho \leq 0.99$ (With SPEC 3 baseband filter) VEM $\leq 3.0\%$ rms (With Nyquist/Root Nyquist baseband filter)			
Spurious emissions	0 dBm output, 30 kHz bandwidth (Forward link/Reverse link, Default)			
	Offset frequency	≥ 750 kHz	≥ 900 kHz	≥ 1.98 MHz
	Baseband filter			
	SPEC 1 + EQ/SPEC 1		≤ -55 dBc	≤ -60 dBc
	SPEC 2 + EQ/SPEC 2	≤ -45 dBc	≤ -60 dBc	≤ -70 dBc
	SPEC 3 + EQ/SPEC 3		≤ -65 dBc	≤ -75 dBc
Level control program function	Variable level in 1 dB steps from RF output level to 0 to -20 dB range in 1.25 ms units (program interval: 800 ms)			
Control signal I/O	Long code trigger input, ESTM output, ESTM alignment output, data output, data clock output, frame clock output, time reference clock output, TTL level, BNC connector (rear panel)			
Auxiliary signal outputs*2	Long code, short code I/Q: TTL level, BNC connector (rear panel) Long code trigger, 26.7 ms clock, 80 ms clock, TTL level, D-sub connector (rear panel)			

*1: This expansion unit cannot be mounted in the MG3670A mainframe.

*2: MG3670B/3671A can mount MG0310A fitted with Option 25, but in this case the auxiliary signal output function is not available.

• MG0312A QPSK Modulation Unit (incorporated in the MG3670B/C, MG3671A/B and MG3672A)*1

Carrier frequency range	10 to 2250 MHz (MG3670B/C), 10 to 2750 MHz (MG3671A/B and MG3672A)		
RF output level	-143 to $+8$ dBm, 0.1 dB steps		
Continuously variable level range	Variable in steps of 0.1 dB in a range of 12 dB ($+8$ to -4 dB) from any RF output level to the upper or lower limit level.		
Modulation system	QPSK, OQPSK		
Bit rate	0.5, 0.512, 1.0, 1.024, 1.5, 2.0, 2.048, 2.4576 Mbps		
Baseband filters	FIR filter*2: FIR 1, FIR 2, FIR 3 (at a bit rate of 2.4576 Mbps) Root Nyquist: $\alpha = 0.3, 0.4, 0.5$ (operable at all bit rates) Nyquist: $\alpha = 0.2, 0.3, 0.4, 0.5$ (operable at all bit rates)		
Vector error (RF output)	$\leq 1.8\%$ rms (bit rate: ≤ 1.5 Mbps), $\leq 3\%$ rms (bit rate: ≥ 2 Mbps, Nyquist/Root Nyquist filters), $\leq 2.2\%$ rms*3 (bit rate: 2.4576 Mbps, FIR 1 filter), $\leq 3\%$ rms*3 (bit rate: 2.4576 Mbps, FIR 2 filter), $\leq 10\%$ rms*3 (bit rate: 2.4576 Mbps, FIR 3 filter) *At ≤ 0 dBm output		
Internal modulation data	Pseudo-random patterns: PN7, PN9, PN15, PN23 Fixed pattern: Iteration of any 16-bit data (Example: 2D2D _H)		
External modulation data	DATA CLOCK: $\pm 5\%$ of the bit rate DATA: Digital data synchronized with the data clock SYMBOL CLOCK: Symbol definition clock synchronized with the data clock (BNC connector, TTL level, polarity selectable)		
I/Q signal output	Selectable between 50 Ω or CMOS (600 Ω), BNC connector		
Phase encoding function	The phase mapping of data on a constellation can be set.		
Spurious emissions	At 2.4576 Mbps bit rate, 0 dBm output level, 30 kHz bandwidth		
	Offset frequency	≥ 900 kHz	≥ 1.98 MHz
	Baseband filter		
	FIR 1	≤ -55 dBc	≤ -60 dBc
	FIR 2, Nyquist $\alpha = 0.2$	≤ -55 dBc	≤ -70 dBc
	FIR 3	≤ -60 dBc	≤ -75 dBc

*1: This expansion unit cannot be mounted in the MG3670A mainframe.

Please consult your sales representative regarding the addition of expansion units to previously purchased MG3670A-11 mainframes.

*2: Finite Impulse Response filter conforming to the TIA/EIA/IS-95 specifications

*3: The waveform quality ρ conforming to the TIA/EIA/IS-95 specifications is ≥ 0.9995 (FIR 1), ≥ 0.999 (FIR 2), ≥ 0.99 (FIR 3).

• Options

Model	Start-up characteristics	Aging rate	Temperature characteristic (0° to 50°C)
MG3670/3671/3672 Option 01	7×10^{-8} /day (after 30 min. warm-up) 3×10^{-8} /day (after 60 min. warm-up)	5×10^{-9} /day (after 24-h warm-up)	$\pm 5 \times 10^{-8}$
MG3670/3671/3672 Option 02	2×10^{-8} /day (after 60 min. warm-up)	2×10^{-9} /day (after 24-h warm-up)	$\pm 1.5 \times 10^{-8}$
MG3670/3671/3672 Option 03	–	5×10^{-10} /day (after 48-h warm-up)	$\pm 5 \times 10^{-9}$
MG3670B Option 20	RF off release function (When RF is off, level display and level setting is enabled.)		
MG0301C Option 22	PHS LCCH super frame control pattern function (artificial base station signal output for field strength measurement: A PS connection test is impossible.)		
MG0302A Option 23	CT2 MUX3 control pattern function		
MG3670B/3671A Option 25	Format upgrade (enables MG0310A to be used in MG3670B/3671A)		

Ordering information

Please specify model/order number, name, and quantity when ordering.

Model/Order No.	Name	
Mainframe		
MG3670B	Digital Modulation Signal Generator	
MG3670C	Digital Modulation Signal Generator	
MG3671A	Digital Modulation Signal Generator	
MG3671B	Digital Modulation Signal Generator	
MG3672A	Digital Modulation Signal Generator	
Expansion units (factory installed)		
MG0301C	$\pi/4$ DQPSK Modulation Unit (for PDC, PDC_H, PHS, NADC and TFTS communication systems)	
MG0302A	GMSK Modulation Unit [for GSM, PCN (DCS1800), and CT2 communication systems]	
MG0303B	Burst Function Unit [for PDC, PDC_H, PHS, NADC, TFTS, GSM, PCN (DCS1800), CT2, DECT, PACS and WCPE communication systems]	
MG0305A	GFSK Modulation Unit (for DECT communication system)	
MG0307A	$\pi/4$ DQPSK Modulation Unit (for PACS, WCPE, PHS communication systems)	
MG0310A	CDMA Modulation Unit (for IS-95 communication system)	
MG0311A	$\pi/4$ DQPSK Modulation Unit (for TETRA communication system)	
MG0312A	QPSK Modulation Unit	
Standard accessories (for mainframe)		
J0576B	Coaxial cord (N-P · 5D-2W · N-P), 1 m:	1 pc
J0127A	Coaxial cord (BNC-P · RG-58A/U · BNC-P), 1 m:	2 pcs
	Power cord, 2.5 m:	1 pc
B0325	Shielded cover for GPIB:	1 pc
F0014	Fuse, 6.3 A (for 100 Vac power supply):	2 pcs
F0012	Fuse, 3.15 A (for 200 Vac power supply):	2 pcs
W0869AE	MG3670B/C operation manual (supplied with MG3670B/C):	1 copy
W0932AE	MG3671A/B operation manual (supplied with MG3671A/B):	1 copy
W1462AE	MG3672A operation manual (supplied with MG3672A):	1 copy
Standard accessories (for expansion units)		
W0872AE	MG0301C/0303B operation manual (supplied with MG0301C):	1 copy
W0691AE	MG0302A/0303B operation manual (supplied with MG0302A):	1 copy
W0851AE	MG0305A/0303B operation manual (supplied with MG0305A):	1 copy
W0949AE	MG0307A/0303B operation manual (supplied with MG0307A):	1 copy
W1183AE	MG0310A operation manual (supplied with MG0310A):	1 copy
B0405A	Exchange sheet for front panel (supplied with MG0310A):	1 pc
B0406A	Exchange sheet for rear panel (supplied with MG0310A):	1 pc
W1050AE	MG0312A operation manual (supplied with MG0310A):	1 copy

For additional units and version upgrades, consult your Anritsu sales representative.

Model/Order No.	Name
Options (for mainframe)	
MG3670/3671/3672-01	Reference oscillator
MG3670/3671/3672-02	Reference oscillator
MG3670/3671/3672-03	Reference oscillator
MG3670-20	RF off release function
MG3670B/3671A-25	Format upgrade
Options (for expansion units)	
MG0301C-22	PHS LCCH super frame control pattern
MG0302A-23	CT2 MUX3 control pattern
Optional accessories	
J0127C	Coaxial cord (BNC-P · RG-58A/U · BNC-P), 0.5 m
J0003A	Coaxial cord (SMA-P · 3D-2W · SMA-P), 1 m
J0576D	Coaxial cord (N-P · 5D-2W · N-P), 2 m
J0004	Coaxial adapter (N-P · SMA-J)
J0007	GPIB cable, 1 m
J0008	GPIB cable, 2 m
B0329D	Protective cover
B0331D	Front handle kit (2 pcs/set)
B0332	Joint plate (4 pcs/set)
B0333D	Rack mount kit
B0334D	Carrying case (with casters and protective cover)
Optional equipment	
MS8604A	Digital Mobile Radio Transmitter Tester
MT8801C	Radio Communication Analyzer
MD1620B	Signalling Tester [PDC 800 MHz, PDC 1.5 GHz (MD1620B-01)]
MD1620C	Signalling Tester (PHS 1.9 GHz)
MD6420A	Data Transmission Analyzer
MP1201C	Error Rate Tester
MS2683A	Spectrum Analyzer

DIGITAL MODULATION SIGNAL GENERATOR

MG3660A

300 kHz to 2.75 GHz

Economy Version of MG3671A with Same Basic Features



GPIO

The MG3660A has all the basic functions of the higher-level MG3670B/C, MG3671A/B, and identical GPIO and front-panel operation. In addition, the same expansion units can be used.

- The MG3660A is an economic version of the MG3671A/B with the same basic features.

Specifications

Carrier frequency	Frequency range	300 kHz to 2750 MHz			
	Accuracy	Depends on installed reference oscillator*1			
	Internal reference oscillator	Frequency: 10 MHz Start-up characteristics: $\leq 1 \times 10^{-7}$ /day (after 30-min. warm-up), $\leq 5 \times 10^{-8}$ /day (after 60-min. warm-up) Aging rate: $\leq 2 \times 10^{-8}$ /day (after 24-h warm-up) Temperature characteristics: $\leq \pm 5 \times 10^{-8}$ (0° to 50°C)			
	External reference input	10 MHz or 13 MHz (± 10 ppm), 2 to 5 Vp-p, BNC connector (rear panel)			
	Reference output	10 MHz, 2 to 5 Vp-p, BNC connector (rear panel)			
Output	Level range	-143 to +13 dBm (resolution: 0.1 dB)			
	Frequency response	Within +1 dB (at 0 dBm output)			
	Level accuracy	Output level/frequency	≤ 1000 MHz	> 1000 MHz	
			-33 to +13 dBm	± 1 dB	± 2 dB
			-123 to -33.1 dBm	± 1.5 dB	± 2 dB
			-136 to -123.1 dBm	± 3 dB	± 4 dB
	Impedance	50 Ω , N-type connector			
Continuously-variable level	Continuously-variable output over 20 dB range (+8 to -12 dB) in 0.1 dB steps within upper and lower limits of any output level				
Level unit	dBm, dB μ , μ V, mV, V (dB μ , μ V, mV, V selected terminate/open voltage display)				
Interference radiation	≤ 1 μ V *measured 25 mm from cabinet (except rear panel) with two-turn 25 mm diameter loop antenna, terminated with 50 Ω load, $\leq +5$ dBm output, carrier wave				
Signal purity	Spurious	≤ -65 dBc (≥ 100 kHz offset, ± 100 MHz bandwidth)			
		≤ -50 dBc (≥ 100 kHz offset, full band)			
		≤ -40 dBc [spurious of (5.4 - Fout) GHz at ≥ 2.65 GHz] ≤ -30 dBc (harmonics)			
SSB phase noise	≤ -116 dBc/Hz (100 kHz offset, CW)				

Continued on next page

Digital modulation	Internal modulation	Depends on installed modulation unit (MG0301C, MG0302A, MG0305A, MG0307A, MG0311A)
	External modulation	Any modulation using I/Q input signal Input frequency: DC to 1.2 MHz*2 Input level: $\sqrt{I^2 + Q^2} \leq 0.5$ Vrms, BNC connector *I/Q : ≤ 1.5 Vp-p (50 Ω), I/Q: $\leq 10\%$ to 100% of 1.5 Vp-p (CMOS) Vector error: $\leq 2.5\%$ rms (I/Q input level: 0.5Vrms/50 Ω , at $\leq +5$ dBm output)
	I/Q output	Outputs I/Q signal at internal modulation (MG0301C, MG0302A, MG0305A, MG0307A, or MG0311A installed)
Pulse modulation	Input	TTL level, BNC connector, polarity selectable
	On/off ratio	≥ 40 dB (at ≥ 0 dBm output)
	Transition time	≤ 2 μ s, minimum pulse width: 10 μ s
Memory function	Frequency memory	1000 carrier frequencies (save and recall)
	Parameter memory	100 panel settings (save and recall)
Other functions	Relative display	Carrier frequency, output level
	I/Q signal adjustment	Offset, balance, phase (only output) of I/Q input/output signal
	Backup	Last settings stored at power-off
	Reverse power protection	Maximum reverse input power: 50 W (<1000 MHz), 25 W (≥ 1000 MHz), ± 50 V (DC)
	GPIB	All functions except power switch and panel lock switch controlled Interface function: SH1, AH1, T6, L4, SR1, RL1, PP0, DC1, DT0, C0, E2
Operating temperature	0° to 50°C	
Power	85 to 132/170 to 250 Vac (automatically selected), 47.5 to 63 Hz, ≤ 350 VA	
Dimensions and mass	426 ± 5 (W) x 221.5 ± 4 (H) x 451 ± 5 (D) mm, ≤ 23 kg	

*1: Internal reference oscillator accuracy: 2×10^{-8} /day (23° $\pm 5^\circ$ C), calibrated after 24-h operation

*2: Refer to the "frequency response for I/Q external modulation (typical value)" shown below for the input frequency range. Typical value are given for reference only to assist in using this instrument, and are not guaranteed specifications.

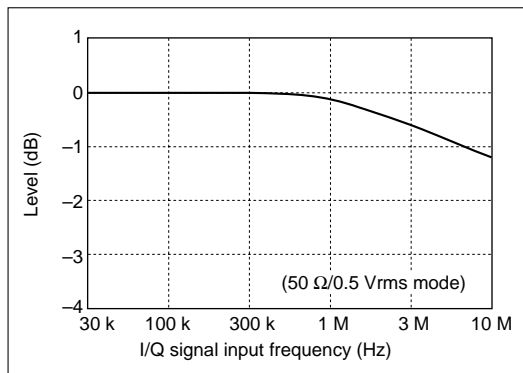

• Expansion units

The MG3660A expansion units can be used with the MG3670B/C, MG3671A/B. For the specifications, refer to page 248. However, when an expansion unit is mounted in the MG3660A, the specifications change as shown below.

MG0301C $\pi/4$ DQPSK Modulation Unit

Vector error	RF signal: $\leq 2.5\%$ rms (± 5 dBm output)
PHS, PDC_H, NADC, TFTS	Carrier frequency: 300 kHz to 2750 MHz
PHS	Carrier frequency: 1 to 2750 MHz Adjacent channel leakage power ratio: ≤ -69 dB (600/900 kHz offset, ± 96 kHz band, ≥ 10 MHz)

MG0302A GMSK Modulation Unit

GSM, PCN (DCS1800)	Carrier frequency: 1 to 2750 MHz
CT2	Carrier frequency: 300 kHz to 2750 MHz

MG0303B Burst Function Unit

RF output	Burst on/off ratio: ≥ 75 dB (± 5 dBm output, PDC, PDC_H, NADC, TFTS, TETRA, CT2)
PHS	Adjacent channel leakage power ratio: ≤ -69 dB (600/900 kHz offset, ± 96 kHz band, ≥ 10 MHz)

MG0305A GFSK Modulation Unit

Vector error	RF signal: ≤ 18 kHz ($\leq +5$ dBm output)
DECT	Carrier frequency: 5 to 2750 MHz

MG0307A $\pi/4$ DQPSK Modulation Unit

Vector error	RF signal: $\leq 2.5\%$ rms ($\leq +5$ dBm output, modulation data FFFF)
PACS, WCPE	Carrier frequency: 1 to 2750 MHz
PHS	Carrier frequency: 1 to 2750 MHz Adjacent channel leakage power ratio: ≤ -69 dB (600/900 kHz offset, ± 96 kHz band, ≥ 10 MHz)

MG0311A $\pi/4$ DQPSK Modulation Unit

Vector error	RF signal: $\leq 2.5\%$ rms ($\leq +5$ dBm output)
TETRA	Carrier frequency: 300 kHz to 2750 MHz Adjacent channel leakage power ratio: ≤ -45 dB (25 kHz offset, ± 9 kHz band) ≤ -62 dB (50 kHz offset, ± 9 kHz band)

Ordering information

Please specify model/order number, name, and quantity when ordering.

Model/Order No.	Name
MG3660A	Main frame Digital Modulation Signal Generator
MG0301C	Expansion units (factory installed) $\pi/4$ DQPSK Modulation Unit
MG0302A	GMSK Modulation Unit
MG0303B	Burst Function Unit
MG0305A	GFSK Modulation Unit
MG0307A	$\pi/4$ DQPSK Modulation Unit
MG0311A	$\pi/4$ DQPSK Modulation Unit
J0576B	Standard accessories (for main frame) Coaxial cord (N-P · 5D-2W · N-P), 1 m: 1 pc
J0127A	Coaxial cord (BNC-P · RG-58A/U · BNC-P), 1 m: 2 pcs
	Power cord, 2.5 m: 1 pc
B0325	Shielded cover for GPIB: 1 pc
F0013	Fuse, 5 A: 2 pcs
W1005AE	MG3660A operation manual: 1 copy
W0872AE	Standard accessories (for expansion units) MG0301C/0303B operation manual (supplied with MG0301C): 1 copy
W0691AE	MG0302A/0303B operation manual (supplied with MG0302A): 1 copy
W0851AE	MG0305A/0303B operation manual (supplied with MG0305A): 1 copy
W0949AE	MG0307A/0303B operation manual (supplied with MG0307A): 1 copy
W1042AE	MG0311A/0303B operation manual (supplied with MG0311A): 1 copy
MG3660A-01	Options (for main frame) Reference oscillator (aging rate: 5×10^{-9} /day)
MG3660A-02	Reference oscillator (aging rate: 2×10^{-9} /day)
MG3660A-03	Reference oscillator (aging rate: 5×10^{-10} /day)
J0127C	Optional accessories Coaxial cord (BNC-P · RG-58A/U · BNC-P), 0.5 m
J0003A	Coaxial cord (SMA-P · 3D-2W · SMA-P), 1 m
J0576D	Coaxial cord (N-P · 5D-2W · N-P), 2 m
J0004	Coaxial adapter (N-P · SMA-J)
J0007	GPIB cable, 1 m
J0008	GPIB cable, 2 m
B0329D	Protective cover
B0331D	Front handle kit (2 pcs/set)
B0332	Joint plate (4 pcs/set)
B0333D	Rack mount kit
B0334D	Carrying case (with casters and protective cover)
MS8604A	Optional equipment Digital Mobile Radio Transmitter Tester
MD1620B	Signalling Tester
MD1620C	Signalling Tester
MD6420A	Data Transmission Analyzer
MP1201C	Error Rate Tester
MS2683A	Spectrum Analyzer

W-CDMA SIGNALLING TESTER MD8480A

For the Development of W-CDMA Mobile Stations

NEW

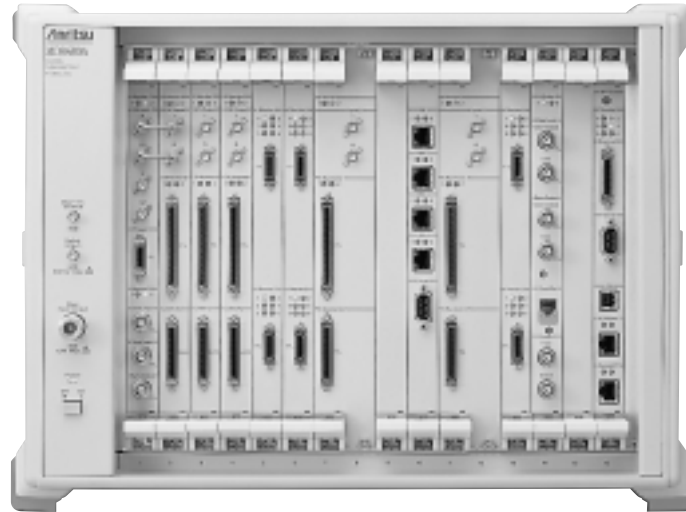

CE GPIB

The MD8480A has a full lineup of advanced functions for testing third-generation W-CDMA mobile stations. Its air interface meets the 3GPP specifications, and it can be used as a base station simulator. The test functions include mobile station modulation and demodulation processing, protocol sequence tests such as location registration, origination, termination, handover (option), disconnection from mobile station/network, various applications such as voice and packet communications as well as communications between two mobile stations.

In summary, the MD8480A is the ideal instrument for developing 3G W-CDMA mobile stations and application software.

Features

- Modulation/demodulation tests for W-CDMA mobile station
- Protocol sequence tests for W-CDMA mobile station
- Flexible settings of test parameters and sequences for protocol sequences
- Voice and packet communications test, and communications testing between two mobile stations

Measurement example

• Modulation/demodulation function tests

In the modulation test, fixed-pattern or PN9 data is output from the mobile station modulation section and compared with the obtained demodulation result on the trace screen of the MD8480A. It is also possible to simultaneously measure BLER and BER (BER requires external BER counter). In addition, the received signal timing error can also be displayed.

In the demodulation test, fixed-pattern or PN9 data is output from the MD8480A and compared with the modulation signal from the mobile station.

• Protocol sequence test

The test items include broadcast information transmission location registration, mobile station origination/termination, disconnection from mobile station/network, and handover (option). In addition, any parameter and sequence can be defined and quasi-normal tests and SMS test are also supported. Furthermore, data communications between the mobile station and MD8480A can be monitored simultaneously. These functions are ideal for efficient troubleshooting and testing the mobile station protocol sequence.

Application tests

• AMR voice test

A handset is connected to the MD8480A to perform a voice test between the mobile station and MD8480A.

• User data test

Any data can be inserted into the DTCH being transmitted and the demodulated DTCH data is output externally. This is an effective method for measuring error rate.

• IP packet test

A PC with 10Base-T connection is connected to the MD8480A to test the IP protocol data communications.

• PPP packet test (option)

A PC with RS-232C is connected to the MD8480A to test the PPP protocol data communications. PPP is the internet dial-up connection protocol.

• PPP test (built-in server)

This is another PPP protocol test in which the PPP protocol stack is executed by the MD8480A that acts as the PPP terminal. The PC functions as the Ethernet medium and performs IP level communications. High-speed Ethernet communications at 384 kbps are supported.

• ISDN test (option)

A videophone, etc., is connected to the MD8480A to test the video and audio communications between the mobile station and MD8480A.

• Communications between two mobile stations test

Two MD8480A are connected by a 10Base-T Ethernet connection to test communications between two mobile stations.

Specifications

General	Frequency range	Tx: 2110 to 2170 MHz, Rx: 1920 to 1980 MHz
	I/O connector	Main N-type, Impedance: 50 Ω, VSWR: ≤1.3 Downlink SMA-type, Impedance: 50 Ω, VSWR: ≤2.0 Uplink SMA type, Impedance: 50 Ω, VSWR: ≤2.0
	Reference oscillator	Frequency: 10 MHz Startup characteristics: ≤5 x 10 ⁻⁸ /day (10 minutes after power-on, reference to 24 hours after power-on) Aging rate: ≤2 x 10 ⁻⁸ /day, ≤1 x 10 ⁻⁷ /year (reference to 24 hours after power-on) Temperature characteristics: ≤5 x 10 ⁻⁸ (0° to 50°C, reference to 25°C) External reference input: 10 MHz, 2 to 5 Vp-p
Transmitter	Frequency	Range: 2110 to 2170 MHz (200 kHz steps)
	Output level	Maximum output level Main: -25 dBm (each channel), -15 dBm (overall) Downlink: -10 dBm (each channel), 0 dBm (overall) Setting resolution: 0.1 dB Accuracy: ±1.5 dB
	Spreading	Codes: Scrambling, channelization, synchronization Chip rate: 3.84 MHz
	Modulation	Method: QPSK Modulation band limit: Root Nyquist filter (a= 0.22) EVM: ≤10% rms
	AWGN	Setting resolution: 0.1 dB
Receiver	Frequency	Range: 1920 to 1980 MHz, Step: 200 kHz
	Input level	Range: -30 to +40 dBm (main), -50 to +20 dBm (uplink)
	Sync.	Rake receive: None, Capture range: ±200 chip (DPCCH), ±100 chip (preamble)
Power	100 to 120/200 to 240 Vac (250 V max.), automatic switching, 47.5 to 63 Hz, ≤430 VA	
Ambient temperature	0° to +50°C (operating), -40° to +70°C (storage)	
Dimensions and mass	426 (W) x 310 (H) x 500 (D) mm, ≤35 kg	
EMC	EN61326: 1997/A1: 1998 (Class A), EN61000-3-2: 1995/A2: 1998 (Class A), EN61326: 1997/A1: 1998 (Annex A)	
LVD	EN61010-1: 1993/A2: 1995 (Installation Category II, Pollution degree 2)	

Option functions

Additional function	MU848057A	MU848058A	MU848055A	MU848053A	MD8480A-01	MX848001A-01	MX848041A-01	MX848041A
2BS soft handover	√	√						
3BS soft handover	√	√*1						
ISDN			√					
Tx diversity (1RF OUT)	√	√*1				√	√*2	
Tx diversity (2RF OUT)	√	√*1		√	√	√	√*2	
Hard handover	√	√*1		√	√			
Ciphering								√

*1: Requires two equipment sets

*2: Requires when using both MX848001A-01 and MX848041A

The options are all shared functions.

• Requires MD8480A + MU848057A + MU848058A + MU848055A for 3BS soft handover function
This configuration also supports 2BS soft handover function.

• Requires MD8480A + MU848057A + MU848058A + MU848055A + MD8480A-01 + MX848001A-01 for Tx Diversity (2RF OUT)
This configuration also supports the 2BS soft handover function, 3BS soft handover function, Tx diversity (1RF OUT) function and hard handover.

Ordering information

Please specify model/order number, name and quantity when ordering.

Model/Order No.	Name
MD8480A	Main frame W-CDMA Signalling Tester
	Unit (incorporated in the main frame)
MU848051A	CPU: 1 pc
MU848052A	Frame Decoder: 1 pc
MU848053A	Rx Baseband: 1 pc
MU848056A	Voice Codec: 1 pc
MU848057A	Frame Coder: 1 pc
MU848058A	Tx Baseband: 1 pc
MU848059A	Timing Generator: 1 pc
	Standard accessories
MX848000A	W-CDMA Signalling Tester Control software: 1 pc
MX848001A	W-CDMA Signalling Tester Firmware: 1 pc
MX848002A	W-CDMA Signalling Tester FPGA: 1 pc
MX848003A	W-CDMA Signalling Tester ISDN/PPP: 1 pc
J0892	10Base-T cross cable, 5 m: 1 pc
G0091	Monitor board: 2 pcs
J1005	Monitor cable, 80-pin: 1 pc
J1006	Monitor cable, 20/50-pin: 1 pc
	Power cord, 2.6 m: 1 pc
J0127F	Coaxial cord (BNC-P · RG58A/U · BNC-P), 1 m: 1 pc
J0576B	Coaxial cord (N-P · 5D-2W · N-P), 1 m: 1 pc
J1010	U-link: 2 pcs
J1007	RS-232C cable (cross), 2 m: 1 pc
F0014	Fuse, 6.3 A: 2 pcs
W1945AE	MD8480A operation manual (CD-ROM): 1 pc
A0010	Blank board (at option uninstalled): 8 pcs
	Option units
MU848053A	Rx Baseband
MU848055A	ISDN
MU848057A	Frame Coder
MU848058A	Tx Baseband
MD8480A-01	Additional RF unit
	Software
MX848001A-01	W-CDMA signalling tester Tx diversity
MX848041A	W-CDMA Signalling Tester Ciphering
MX848041A-01	Tx Diversity for Ciphering
	Peripherals
G0082	Personal computer*1 (for control)
Z0430	Microsoft Visual C++ V6.0*2 (standard edition)

*1 OS: Windows 95/98/ME/2000, Windows NT4.0 Workstation
CPU: 200 MHz or better with minimum of 32 MB of memory and 10Base-T and RS-232C interfaces (D-Sub 9pin) and CD-ROM drive.

*2 Microsoft Visual C++ Version 6.0 is a registered trademark of Microsoft Corporation in USA and other countries.

SIGNALLING TESTER
MD1620B

PDC 800 MHz, PDC 1.5 GHz (Option 01)

For Testing General Operations and Functions of PDC Terminals



GPIB

The MD1620B has all functions which are necessary for operation tests and function tests of mobile stations for PDC system for a 800 MHz band (1.5 GHz band: Option 01). It has an air-interface based on RCR STD-27C and works as a simulator for the base station. The MD1620B can test sequences, such as standby, location registration, call initiated/call present, channel handover, disconnection by the network end, and disconnection by the mobile station. It also provides many measurement and test functions, such as time alignment and handover time measuring function, real-time display of information reported from the mobile station during communications with the base station, and controls to the mobile station.

The MD1620B is the best choice for connection tests at the last stage of production lines and for function tests at the development stage.

With the MS8604A Digital Mobile Radio Transmitter Tester and the MG3670B/C, MG3671A/B, and MG3660A Digital Modulation Signal Generator, measuring systems for digital cellular systems can be easily constructed.

Features

- Can set parameters and sequences used for sequence tests
- Can test layer 3 semi normal sequences
- Can do real-time measurements of time alignment and handover time
- Can easily create digital cellular measuring systems
- Provides easy-to-use operation system by windows and menu selections

Measurement example

- **By pressing a key once the sequence measurement starts**

By pressing the [Start] key once, the screen display changes to the sequence monitor screen, and the sequence test starts automatically. The test item under measurement is displayed in a reverse-display mode, and a position displayed in a reverse-mode moves as the test is proceeding.

Each result of the test is indicated with a mark ("•" or "X"). For example, [• Registration] is displayed when the location registration sequence is performed correctly, and [X Registration] when errors are detected during the location registration sequence test. When a series of the sequence tests are completed and all the items are displayed with "•" marks, an operator knows at a glance that the mobile station under test has passed.

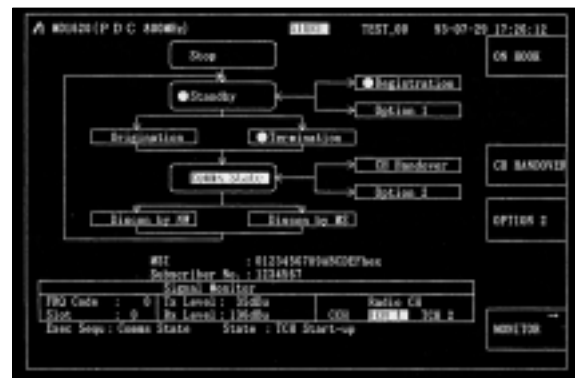

Sequence monitor

- **Real-time display of time alignment and handover time**

The conditions of the mobile station under test are displayed in real-time on the monitor screen of the execution condition. And also, the MD1620B can control time alignment (TA) and transmitting power (POW) to the mobile station.



Execution condition monitor

• Can freely set the parameters of the control channel and the traffic channels

A control channel that the MD1620B sends out as a simulator of the base station and broadcast information are set on the control channel setting screen and traffic channels are set on the traffic channel setting screen. For channel handover during communications, the test is performed by alternatively switching the traffic channel 1 and the traffic channel 2.



Control channel setting



Traffic channel setting

• Can freely set layer 3 sequences

Sequences used for location registration, call initiated/call present, channel handover, disconnection by the mobile station, and disconnection by the network end can be freely changed. Also, information elements included in each message can be freely set. Moreover, the tester can set arbitrary sequences to Option 01 and Option 02 and be used for testing of RT sequence during communications and semi-normal sequence.

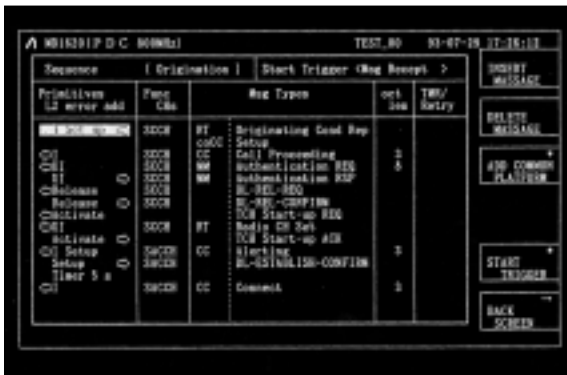

Sequence setting

Specifications

Tx	Frequency range	810 to 826 MHz, 1477 to 1501 MHz (Option 01), 860 to 898 MHz (Option 03), 834 to 843 MHz (Option 06)
	Frequency setting interval	25 kHz steps
	Number of carriers	2
	Transmission level range	13 to 83 dBμV ^{*1} /carrier
	Transmission level accuracy	±2 dB (24 to 83 dBμV) at 25° ±5°C
Rx	Frequency range	940 to 956 MHz, 1429 to 1453 MHz (Option 01), 915 to 940 MHz (Option 03), 889 to 898 MHz (Option 06)
	Frequency setting interval	25 kHz steps
	Number of carrier	1
	Receiving level range	77 to 149 dBμV ^{*1}
	Receiving error rate	BER ≤ 1 × 10 ⁻⁶ at 77 dBμV
Reference oscillator	Frequency	10 MHz
	Stability	Aging rate: 2 × 10 ⁻⁸ /day, 2 × 10 ⁻⁷ /year Temperature characteristic: ±5 × 10 ⁻⁸ (relative to 25°C)
	External reference input signal	10 MHz, 2 to 5 Vp-p
External control	GPIB: SH1, SR1, DC1, C0, AH1, RL1, DT0, T5, PPO, L4 RS232C bit rate: 600, 1200, 2400, 4800 bps	
Floppy	3.5-inch floppy disk, MS-DOS ^{*2} format 2DD format: 720 KB (when formatted) 2HD format: 1.2 MB (when formatted)	
Power	85 to 132 Vac, 47.5 to 63 Hz, ≤230 VA	
Temperature range	0° to 50°C (5° to 45°C when using a floppy)	
Dimensions and mass	426 (W) x 221.5 (H) x 451 (D) mm, ≤20 kg	

*1: 0 dB μV = -113 dBm

*2: MS-DOS is a registered trademark of Microsoft Corporation.

Ordering information

Please specify model/order number, name, and quantity when ordering.

Model/Order No.	Name
MD1620B	Main frame Signalling Tester
	Standard accessories
J0576B	Coaxial cord (N-P · 5D-2W · N-P), 1 m: 2 pcs
F0012	Fuse, 3.15 A: 2 pcs
	Power cord, 2.5 m: 1 pc
Z0244A	System disc (3.5-inch): 1 pc
Z0244B	System disc for back-up (3.5-inch): 1 pc
Z0244C	Software disc for test (3.5-inch): 1 pc
W0685AE	MD1620B operation manual: 1 copy
	Options
MD1620B-01	PDC 1.5 GHz
MD1620B-03	PDC 800 MHz band frequency extend option
MD1620B-06	PDC 800 MHz 3 band extend option
MD1620B-13	Trace function
	Optional accessories
CU10NA3S-C	Circulator (810 to 956 MHz, TDK)
CU111A3N-C	Circulator (1429 to 1513 MHz, TDK)
J0007	GPIB cable, 1 m
J0008	GPIB cable, 2 m
J0324	RS232C cable, 3 m
B0329D	Cover
B0331D	Front handle (2 pcs/set)
B0332	Joint plate (4 pcs/set)
B0333D	Rack mount kit
B0334D	Carrying case (with a cover and casters)

Notes:

- The MD1620B is developed according to RCR STD-27C. However, test sequences for Appendix 1 (authentication and encryption) is not provided.
- When connecting the MD1620B to a MS with a cable or antennas, a circulator optionally provided is necessary.
- Optional trace function stored on a system disk can be used only with the MD1620B having the same serial number as the number indicated on the system disk.

SIGNALLING TESTER
MD1620C
 PHS 1.9 GHz

For Testing General Operations and Functions of PHS Terminals

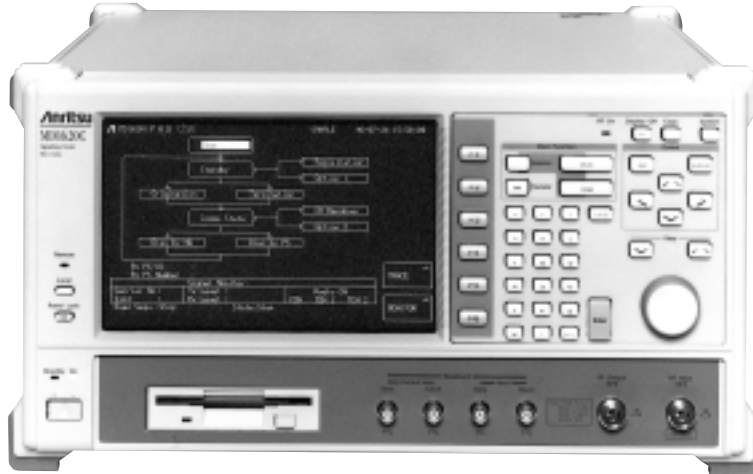

Custom-made product

GPiB

The MD1620C has all the functions needed for operation tests and function tests of CS/PS for PHSs. The MD1620C has an air-interface according to RCR STD-28 and can be used as a PS/CS simulator. Control sequences, such as standby, registration, origination, termination, CH handover, disconnection-by-CS, and disconnection-by-PS can be tested.

The MD1620C is the best choice for connection tests at the last stage of production lines of PS/CS and for function tests at the development stage. With the MS8604A Digital Mobile Radio Transmitter Tester and the MG3670B/3671A/3660A Digital Modulation Signal Generator, measuring systems for PHS systems can be constructed easily.

Features

- The MD1620C has a built-in CODEC, and communication tests between the simulator and a CS/PS are possible using a hand-set supplied as a standard accessory.
- Parameters and optional sequences for tests can be freely defined.
- Layer-3 sequences can be freely defined and layer 3 semi-normal sequence tests are possible.
- Defined sequences and parameters can be stored on a 3.5 inch floppy disk.
- Easy-to-use operation system by windows and menu selection method

Measurement example

• Sequence test starts at a stroke of a key

By pressing the [Start] key on the front panel, the screen changes to the sequence monitor screen, and the sequence test starts. Execution conditions and test results of the sequence test are displayed as a flowchart. The test sequence under execution is indicated with a cursor in a reverse display mode, shown in the figure top right, and the cursor moves to next test sequence as the test proceeds. Sequence test results are indicated with a mark ("•" or "X"). For example, when the registration sequence is performed correctly, the "•" mark is displayed on its left side, and the "X" mark is displayed when an error is detected. When the sequence test ends and each sequence is displayed with the "•" mark, an operator knows at a glance that a DUT is OK.

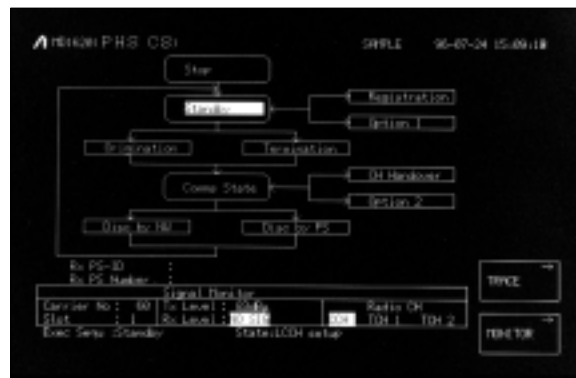

Sequence monitor screen (CS simulation mode)

• Real-time display of slot error rates and a receiving level

The MD1620C displays slot error rates and a receiving level (the transmission level from a PS) in real time. By turning a rotary knob on the front panel, a transmission level can be continuously varied.

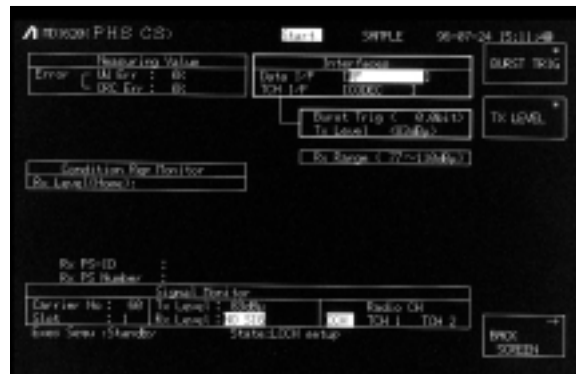

Execution condition monitor screen (CS simulation mode)

- Control signals of up-link and down-link can be displayed by using a trace function provided as an option.

By using the trace function, up-link and down-link control signals sent or received by PS or CS during a sequence test are stored in built-in memories and are displayed after the sequence test ends. Max. 100 steps back from the test end are displayed in layer 2 and layer 3 levels and with elapsed time in 10 ms steps. This function allows engineers to find out the cause(s) when errors occurred during the sequence test and is indispensable to software debug and tests.



Trace screen (CS simulation mode)

- Can be freely defined layer 3 sequences

Basic test sequences, such as registration, origination, termination, handover, disconnection by CS, and disconnection by PS are stored on a 3.5-inch floppy disk supplied as a standard accessory. In addition, sequences according to user's applications can be defined by modifying the basic test sequences or adding messages to the sequence, and parameters in messages can be set freely. By defining arbitrary sequences in Option 01 and Option 02, sequence tests for supplement service and semi-normal sequence can be done.



Sequence setting screen (CS simulation mode: origination sequence)

- Can freely set parameters of the control/communication CH

When being used as a CS simulator, a control CH and broadcasting information that the MD1620C sends can be set at the control CH setting screen and communications CH can be set at the communication CH screen. Handover test during communications can be performed by alternating a communication CH 1 and a communication CH 2.



Control CH setting screen (CS simulation mode)

- Parameters and sequences defined can be stored on a 3.5-inch floppy disk.

Parameters and test sequences defined can be stored as a file on a floppy disk (up to 100 files can be stored). Trace data resulting from using the trace function can be also stored on a floppy disk.



File management screen



Communication CH setting screen (CS simulation mode)

Specifications

Tx	Frequency range	1895.15 to 1917.95 MHz
	Frequency setting interval	300 kHz steps
	Number of carriers	2 carriers
	Transmission level range	13 to 83 dB μ V*1 per carrier
	Transmission level accuracy	± 2 dB (24 to 83 dB μ V) at 25° $\pm 5^{\circ}$ C
Rx	Frequency range	1895.15 to 1917.95 MHz
	Frequency setting interval	300 kHz steps
	Number of carriers	1 carrier
	Receiving level range	77 to 149 dB μ V*1
	Receiving error rate	BER $\leq 1 \times 10^{-8}$ at 77 dB μ V
Reference oscillator	Frequency range	10 MHz
	Stability	Aging rate: 2×10^{-8} /day, 2×10^{-7} year Temperature characteristics: $\pm 5 \times 10^{-8}$ (referred at 25°C)
	External reference input signal	10 MHz, TTL level
External control		GPIB: SH1, SR1, DC1, C0, AH1, RL1, DT0, T5, PP0, L4 RS-232C bit rate: 600, 1200, 2400, 4800 bps
Floppy		3.5-inch floppy disk, MS-DOS*2 format 2DD format: 720 KB (when formatted) 2HD format: 1.2 MB (when formatted)
Power		85 to 132/170 to 250 Vac, 47.5 to 63 Hz, ≤ 230 VA
Dimensions and mass		426 (W) x 221.5 (H) x 451 (D) mm, ≤ 20 kg

*1: 0 dB μ V = -113 dBm

*2: MS-DOS is a registered trademark of Microsoft Corporation.

Ordering information

Please specify model/order number, name, and quantity when ordering.

Model/Order No.	Name	
MD1620C	Main frame Signalling Tester (Custom-made product)	
	Standard accessories	
J0576B	Coaxial cord (N-P · 5D-2W · N-P), 1 m:	2 pcs
F0012	Fuse, 3.15 A:	2 pcs
	Power cord, 2.5 m:	1 pc
Z0252A	System disk (3.5-inch):	1 pc
Z0252B	System disk for back-up (3.5-inch):	1 pc
Z0252C	Disk for calibration (3.5-inch):	1 pc
G0057	Hand-set	1 pc
W0778AE	MD1620C operation manual:	1 copy
	Option	
MD1620C-13	Trace function	
MD1620C-15	Frequency expansion	
	Optional accessories	
CU111A3N-C	Circulator (1895 to 1918 MHz, TDK product)	
J0657	Adapter (N-P · SMA-J)	
J0658	Adapter (SMA-P · SMA-J), L-type	
J0007	GPIB cable, 1 m	
J0008	GPIB cable, 2 m	
J0324	RS-232C cable, 3 m	
B0329D	Cover	
B0331D	Front handle (2 pcs/set)	
B0332	Joint plate (4 pcs/set)	
B0333D	Rack mount kit	
B0334D	Hard carrying case (with covers and casters)	

Notes:

- The MD1620C is developed according to RCR STD-28. However, test sequences for Appendix 1 (authentication) and Appendix 2 (subscriber data write-in) are not provided.
- When connecting the MD1620C to a PS or a CS with a cable or antennas, a circulator optionally provided is necessary.
- Optional trace function stored on a system disk can be used only with the MD1620C having the same serial number as the number indicated on the system disk.

Bluetooth™ TEST SET MT8850A

2.4 GHz Reference Bluetooth Transceiver

Test Bluetooth Modules and Products with a Bluetooth Interface

NEW



The MT8850A is Anritsu's entrant into the fast-growing *Bluetooth* world of wireless communications for mobile PCs, mobile phones and other portable devices. The MT8850A *Bluetooth* Test Set measures the radio performance of *Bluetooth* modules and *Bluetooth* products – quickly and at low cost.

Features

• Fast

The rapid "Quick Test" measurement script is pre-configured for ease of operation. Production test scripts can run in as little as 10 seconds, measuring power, frequency, modulation and receiver sensitivity (BER).

• One touch testing

Once the MT8850A has been configured, each device is tested with a single keystroke. Press RUN to initiate a link, activate a test mode, perform the measurement, and report the results.

• Authoritative

Tests are made exactly as defined in the *Bluetooth* RF Test Specification. All measurements are traceable to National Standards so that you can be totally confident in both your production testing and design proving.

• Reference *Bluetooth* transceiver

A custom designed transceiver offers 1 kHz frequency accuracy at the start of any packet, and it is in full compliance with the requirements for the "Dirty Transmitter" for true receiver sensitivity measurements. In addition to the standard dirty transmitter table, you can define customized stress conditions with user-settable values of Carrier Frequency Offset Modulation Index, Symbol Timing Error, and simulated carrier frequency drift.

• Remote control

Both GPIB and RS 232 interfaces are offered as standard. Creating test programs has been simplified by the MT8850A's capability for initiating a test using a single command and then having results returned in a single string.

• Small size and weight

MT8850A takes up minimal space in your test system, thanks to its half-rack size and light weight. Where *Bluetooth* interfaces are being introduced into existing products, the disturbance to the test system is minimized.

• Editing tests

Define your own test scripts for customizing test measurements to your specific requirements. Each test can be enabled or disabled and within any other test; parameters, such as hopping, and can be enabled or disabled; the number of measured packets can be defined and the specific test frequencies initiated.

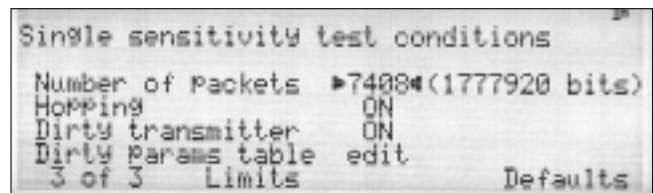

• Single test mode

A single test can be run continuously. This allows, for example, the BER of a link to be monitored as additional interfering *Bluetooth* devices are activated or the distance between the EUT and the MT8850A is increased.

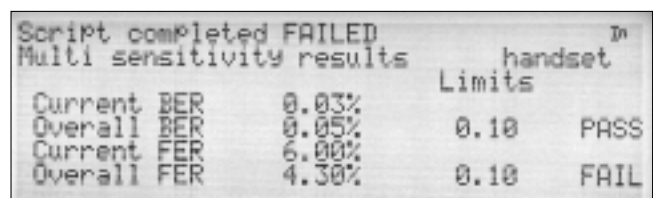

• Making a link

The BT address can be entered manually using the keypad, or it can be discovered and selected using Inquiry via the GPIB or RS 232 interface, or it can be read through the EUT HCI interface (RS 232). Once the EUT BT address is known a *Bluetooth* link is established using Paging. This process typically takes 200 ms.

• Field upgradeable

The *Bluetooth* protocol stack is held in FPGA so that future versions of the core *Bluetooth* specification can be installed locally. The instrument's main program is held in flash memory; consequently, product enhancements can be downloaded in the field.

• **Design proving**

Because measurements are made in accordance with the *Bluetooth* RF Test Specification, the MT8850A is the ideal instrument for pre-conformance testing and design proving. The MT8850A lets you gain confidence in your product before submitting it to a *Bluetooth* Qualification Test Facility for approval. For the TX output spectrum and spurious emissions tests, the MT8850A can establish a BT link and set the EUT to transmit the appropriate DH1 packets at a fixed

frequency _ just add an Anritsu MS2661C or MS2665C Spectrum Analyzer to your test system.

• **BlueSuite support software**

A complementary BlueSuite software package gives PC control of the MT8850A for advanced design proving measurements on *Bluetooth* radios. Use BlueSuite to view burst power profiles, modulation eye diagrams, display graphs of the output power of the 79 frequencies and many other advanced diagnostic tools.

Specifications

Output power	General	MT8850A measures average and peak power according to the <i>Bluetooth</i> RF Test Specification measurement of output power is made with the EUT in test mode, loopback enabled and hopping on. MT8850A transmits the longest supported packets and longest supported payload length with a PRBS 9 payload. Power is measured at three defined frequencies. MT8850A identifies the position of p0 and measures the power of every bit in the packet.		
	Link conditions	Hopping	ON	
		Test mode	ON	
		Loopback	Loopback only	
		Payload	PRBS 9	
		Packet type	Longest supported	
	Measurement	Supported measurements	Average power, peak power	
		Number of measurement frequencies	Three, default to qualification specification or user defined	
		Measurement range	+22 dBm to -35 dBm average power (+23 dBm peak power)	
		Resolution	0.1 dB	
Accuracy		+20 dBm to -35 dBm, ±1 dB +22 dBm to +20 dBm, ±1.5 dB		
Power control	General	MT8850A measures power control according to the <i>Bluetooth</i> RF Test Specification. Measurement of power control is made with the EUT in test mode, loopback enabled, and hopping off. MT8850A transmits DH1 packets, with a PRBS 9 payload. Power control is measured at three defined frequencies. MT8850A uses standard LMP commands to set the EUT power. MT8850A identifies the position of p0 and measures the power of every bit in the packet.		
	Link conditions	Hopping	OFF	
		Test mode	ON	
		Loopback	Loopback only	
		Payload	PRBS 9	
		Packet type	DH1	
	Measurement	Supported measurements	Average power at each power step, step size	
		Number of measurement frequencies	Three, default to qualification specification or user defined	
		Measurement range	+22 dBm to -35 dBm average power (+23 dBm peak power)	
		Resolution	0.1 dB	
Accuracy		+20 dBm to -35 dBm, ±1 dB +22 dBm to +20 dBm, ±1.5 dB		
Modulation characteristics	General	MT8850A measures modulation characteristics according to the <i>Bluetooth</i> RF Test Specification. Measurement of modulation characteristics is made with the EUT in test mode, loopback enabled, and hopping off. MT8850A transmits longest supported packets with the defined payload to the EUT. Modulation characteristics are measured at three defined frequencies.		
	Link conditions	Hopping	OFF	
		Test mode	ON	
		Loopback	Loopback or TX mode	
		Payload	11110000 and 10101010	
		Packet type	Longest supported	
	Measurement	Supported measurements	Frequency deviation. $\Delta f1_{max}$, $\Delta f2_{max}$, $\Delta f1_{avg}$, $\Delta f2_{avg}$ and $(\Delta f2_{avg}/\Delta f1_{avg})$	
		Number of measurement frequencies	Three, default to qualification specification or user defined	
		RF input measurement range	+20 dBm to -35 dBm	
		Deviation measurement range	0 Hz to 350 kHz peak	
Deviation resolution		1 kHz		
Accuracy	1 kHz			

Continued on next page

Initial carrier frequency tolerance	General	MT8850A measures initial carrier frequency tolerance according to the <i>Bluetooth</i> RF Test specification. Measurement of initial carrier frequency is made with the EUT in test mode, TX mode and hopping on and/or off. MT8850A transmits DH1 packets, with a PRBS 9 payload. Initial carrier frequency is measured at three defined frequencies. MT8850A identifies the position of p0 and measures the average frequency of the 4 preamble bits.		
	Link conditions	Hopping	OFF and ON	
		Test mode	ON	
		Loopback	Loopback or TX mode	
		Payload	PRBS 9	
		Packet type	DH1	
	Measurement	Supported measurements	Initial carrier frequency error	
		Number of measurement frequencies	Three; default to qualification specification or user defined	
		RF input measurement range	+20 dBm to -35 dBm	
		Initial frequency error measurement range	0 Hz to ± 150 kHz	
		Frequency resolution	1 kHz	
Accuracy		1 kHz		
Carrier frequency drift	General	MT8850A measures carrier frequency drift according to the <i>Bluetooth</i> RF Test Specification Measurement of frequency drift is made with the EUT in test mode, with either loopback or transmitter test mode enabled. EUT transmits longest supported packets with a 10101010 payload to the EUT. Measurements are made with hopping off and then with hopping on. Frequency drift is measured at three defined frequencies with hopping off and every frequency with hopping on.		
	Link conditions	Hopping	OFF and ON	
		Test mode	ON	
		Loopback	Loopback or TX mode	
		Payload	10101010	
		Packet type	All supported packet lengths	
	Measurement	Supported measurements	Carrier frequency drift	
		Number of measurement frequencies	Three with hopping off then every frequency with hopping on	
		RF input measurement range	+20 dBm to -35 dBm	
		Frequency drift measurement range	0 Hz to 200 kHz, and > 2000/50 μ s	
		Frequency resolution	1 kHz	
		Accuracy	1 kHz	
	Sensitivity - single slot packets	General	MT8850A measures single slot sensitivity according to the <i>Bluetooth</i> RF Test Specification. BER and FER are measured with the EUT in test mode and loopback on. MT8850A transmits DH1 packets, with a PRBS 9 payload to the EUT. The user can select to run the measurement with hopping on or off. Dirty transmitter conditions as defined in the <i>Bluetooth</i> test specifications can be enabled.	
		Link conditions	Hopping	OFF or ON, user selectable
			Test mode	ON
			Loopback	ON
Payload			PRBS 9	
Packet type			DH1	
Dirty transmitter (as defined in RF test spec)			ON or OFF, user selectable	

Continued on next page

Sensitivity - single slot packets	Measurement	Supported measurements	BER, total number of bit errors and FER			
		Number of measurement frequencies	Three with hopping off, or hopping on			
		Number of measured bits	1 to 32,768 packets (216 to 7,077,888 bits)			
		MT8850A transmitter output range	0 dBm to -80 dBm, resolution 0.1 dB			
		BER/FER measurement range	0.00% to 100%			
		BER/FER resolution	0.01%			
		Dirty transmitter specification	MT8850A transmits the first 20 ms with the first set of measurement conditions, the second 20 ms with the second set of measurement conditions up to the tenth set of conditions. The cycle is then repeated until the test is complete.			
			Measurement conditions	Carrier frequency offset	Modulation index	Symbol
			1	75 kHz	0.28	-20 ppm
			2	14 kHz	0.30	-20 ppm
			3	-2 kHz	0.29	+20 ppm
			4	1 kHz	0.32	+20 ppm
			5	39 kHz	0.33	20 ppm
			6	0 kHz	0.34	-20 ppm
7	-42 kHz		0.29	-20 ppm		
8	74 kHz		0.31	-20 ppm		
9	-19 kHz	0.28	-20 ppm			
10	-75 kHz	0.35	+20 ppm			
In addition to the above measurement conditions, MT8850A transmits with a sine wave, frequency modulation, with a deviation of ± 25 kHz, rate 1.6 kHz, synchronized to zero phase at the packet start.						
Dirty transmitter user control	Any entry in the dirty transmitter table can be edited within the following ranges: <ul style="list-style-type: none"> Carrier frequency offset: 0 Hz to 100 kHz, 1 kHz resolution Modulation index 0.25 to 0.38, 0.01 resolution Symbol timing error: 0 ppm, +20 ppm or 20 ppm 					

Sensitivity - multi-slot packets	General	MT8850A measures multi-slot sensitivity according to the <i>Bluetooth</i> RF Test Specification. BER and FER are measured with the EUT in test mode and loopback on. MT8850A transmits DH5 packets (or DH3 packets if DH5 not supported by EUT), with a PRBS 9 payload to the EUT. The user can select to run the measurement with hopping on or off. Dirty transmitter conditions as defined in the <i>Bluetooth</i> test specifications can be enabled.		
	Link conditions	Hopping	OFF or ON, user selectable	
		Test mode	ON	
		Loopback	ON	
		Payload	PRBS 9	
		Packet type	DH5 (or DH3 packets if DH5 not supported by EUT)	
		Dirty transmitter (as defined in RF test spec)	ON or OFF, user selectable measurement	
	Measurement	Supported measurements	BER, total number of bit errors and FER	
		Number of measurement frequencies	Three with hopping off, or hopping on	
		Number of measured bits	1 to 32,768 packets (for DH3, 1,464 to 47,972,352 bits), (for DH5, 2,712 to 88,866,816 bits)	
		MT8850A transmitter output range	0 dBm to -80 dBm, 0.1 dB resolution	
		BER/FER measurement range	0.00% to 100%	
		BER/FER resolution	0.01%	
Dirty transmitter specification		As for single-slot sensitivity section except; in addition to the measurement condition table, MT8850A transmits with a sine wave, frequency modulation, with a deviation of ± 40 kHz, rate 500 Hz (3 slots) or 300 Hz (5 slots), synchronized to zero phase at the packet start.		

Continued on next page

Maximum input level	General	MT8850A measures BER and FER at the EUT maximum input level according to the <i>Bluetooth</i> RF Test Specification. Measurement is made with the EUT in test mode, loopback enabled, and hopping off. MT8850A transmits the DH1 packets with a PRBS 9 payload. The MT8850A transmitter level is set so that the EUT receiver input level is -20 dBm. BER and FER are measured at three defined frequencies.		
	Link conditions	Hopping	OFF	
		Test mode	ON	
		Loopback	ON	
		Payload	PRBS 9	
		Packet type	DH1	
	Measurement	Supported measurements	BER and FER for -20 dBm at receiver input	
		Number of measurement frequencies	Three, default to qualification specification or user defined	
		Number of measured bits	1 to 32,768 packets (216 - 7,077,888 bits)	
		Transmitter power settable range	0 dBm to -80 dBm	
Resolution		0.1 dB		
EUT control interface	Provides HCI commands to EUT through a standard RS 232 interface. Interface meets requirements of <i>Bluetooth</i> V1.1 specification for HCI UART transport layer. Cable supplied.			
Frequency standard	Frequency	10 MHz		
	Accuracy	±0.5 ppm at 25°C		
	Temperature Stability	±0.5 ppm, -10°C to +85°C		
	Aging (1st year)	±1.0 ppm		
	Aging (over 10 years)	±2.5 ppm, including year 1		
Rear panel connectors	External frequency standard input	Rear panel BNC socket, 50 Ω 1 volt		
	Output 1	TTL high when MT8850A TX on		
	Output 2	TTL high when MT8850A RX active		
	Input 1	For service use only		
GPIB	IEEE 488.2 Offers full instrument control as standard. User can also read the 4 x over-sampled magnitude and frequency values of each data bit in the last measured packet			
RS 232	RS 232 interface offering full instrument control as standard			
Power requirements	Supply	85 to 264 Volts AC 47 to 63 Hz 150 VA MAX		
Environmental	Operating temperature	5 to +40°C		
	Operating humidity	20% to 75%		
	Safety	Complies with IEC 1010-1		
	EMC	Conforms to the protection requirements of EEC Council Directive 89/336/EEC.		
Size and weight	Dimensions	216.5 mm x 88 mm x 380 mm		
	Weight	<3.45 kg		

Continued on next page

MT8850A signal generator		
Frequency	Frequency range	2.40 to 2.5 GHz
	Frequency resolution	1 kHz
	Frequency accuracy	As frequency standard ± 25 Hz
	Settling time (when hopping)	<160 μ s to ± 75 kHz during the establishing of a link. When a link has been established and the EUT been placed into test mode, the MT8850A transmitter is pre-tuned to ± 1 kHz of the nominal channel frequency at the beginning of its data burst for both fixed frequency or hopping measurements.
Level	Amplitude range	0 dBm to -80 dBm
	Amplitude accuracy	± 1 dB
	Amplitude resolution	± 0.1 dB
	Output impedance	50 Ω (nominal)
	Output VSWR	1.5:1 (typically 1.3) Adjacent channels 3 or higher -40 dBc
Modulation	Spurious	30 MHz to 1 GHz; -36 dBc 1 GHz to 12 GHz; -30 dBc 1.8 GHz to 1.9 GHz; -47 dBc 5.15 GHz to, 5.3 GHz; -47 dBc or -80 dBm, whichever is greater
	Modulation	GFSK
	Modulation index	Variable, 0.25 to 0.38 (125 kHz to 190 kHz)
	Mod index resolution	0.01
	Mod index accuracy	1 kHz
	Baseband filter	BT=0.5
MT8850A measuring receiver		
Frequency	Range	2.40 to 2.5 GHz
	Resolution	1 kHz
	Settling time	<160 μ s to 75 kHz during the establishment of a link. When a link has been established and the EUT has been placed into test mode, the MT8850A receiver is pre-tuned to ± 1 kHz of the nominal channel frequency.
	Accuracy	As frequency standard ± 25 Hz
	Measurement channel bandwidth	3 MHz
Level	Range Power measurement accuracy	+22 dBm to -35 dBm average power ± 1 dB (+20 dBm to -35 dBm)
	Input VSWR	1.5:1
	Damage level	+25 dBm
	Resolution	0.1 dB
Modulation	Modulation	GFSK
	Deviation measurement range	0 to 350 kHz peak
	Accuracy	1 kHz

Ordering information

Please specify model/order number, name, and quantity when ordering.

Model/Order No.	Name
MT8850A	<i>Bluetooth</i> Test Set Included accessories Power cord for destination country Operation manual RS232 cable for firmware update Remote control programming manual Certificate of calibration EUT control interface lead (RS232)

Model/Order No.	Name
	Options and accessories
MT8850A-01	Rack mount kit, single unit
MT8850A-03	Rack mount kit, side by side
MT8850A-06	rear mount RF and EUT connectors
MT8850A-10	<i>Bluetooth</i> antenna and adapter
MT8850A-20	Spare EUT control interface lead (RS 232)
MT8850A-30	Extra Operation and Remote control programming manual
D41310	Soft carry case
760-209	Hard transit case

RADIO COMMUNICATION ANALYZER

MT8820A

30 MHz to 2.7 GHz

Supports Third Generation W-CDMA

NEW



CE GPIB

4

The MT8820A hardware platform covers a frequency range of 30 MHz to 2.7 GHz.

When dedicated measurement software and hardware (options) are installed, this single platform supports evaluation of all the main transmission/reception test items for W-CDMA terminals.

Advanced DSP and parallel measurement technologies dramatically reduce wireless manufacturing and inspection test times. Furthermore, several measurement items can be selected freely for batch measurement.

A one-touch operation also allows for each selected batch measurement item to be executed repeatedly for a designated number of times. Pass/fail evaluation of the main measurement items including transmission frequency, modulation accuracy, output power, adjacent channel power, occupied frequency bandwidth, BER, etc., can be performed easily and quickly.

The built-in GPIB interface enables the MT8820A to be integrated into automated production lines as well as to configure an automated test system for after-sales maintenance.

W-CDMA measurement functions

(Using Option 01 and W-CDMA measurement software)

• Transmitter tests

Output power

This test measures the output power of the W-CDMA terminal with the power controlled to maximum, minimum and any other power. When the number of measurements is set to two or more, the max., mean, and min. values of the result are displayed, providing evaluation of the terminal randomness. This repeat measurement function is also supported for other measurements.



Tests	3GPP TS34.121	Test items
Transmitter tests	5.2	Max. peak transmission power
	5.3	Frequency error
	5.4.3	Min. transmission power
	5.5.1	Transmission off power
	5.8	Occupied frequency bandwidth (OBW)
	5.9	Spectrum radiation mask
	5.10	Adjacent channel power ratio (ACLR)
	5.13.1	Error vector amplitude (EVM)
Receiver tests	5.13.2	Peak code domain error
	6.2	Reference sensitivity level
	6.3	Max. peak input level

Frequency error

This test measures the frequency error of the W-CDMA terminal. The absolute error (kHz) and relative error (ppm) can be measured and displayed simultaneously.

Occupied frequency bandwidth

This test measures the occupied frequency bandwidth of the W-CDMA terminal. The ratio of the frequency band to the total power can be changed in the range of 80.0% to 99.9%.

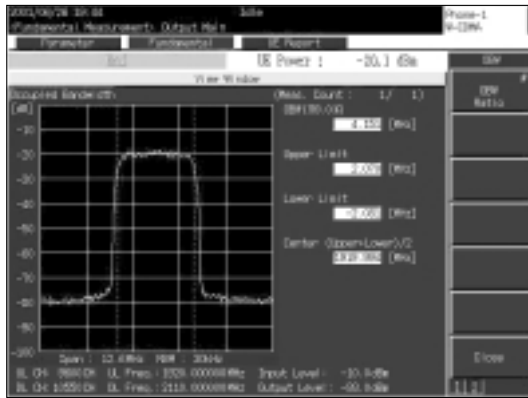

Spectrum emission mask

This function performs pass/fail evaluation of the W-CDMA terminal spectrum emission mask. Frequency components are checked within ± 12.5 MHz of the center frequency that are exceeding the specified limits of the 3GPP standards.

Adjacent channel power

This test measures the adjacent channel power of the W-CDMA terminal. The leakage power at points ± 5 and ± 10 MHz from the center frequency can be measured at high speed using an advanced measurement algorithm.



Modulation analysis

This test performs modulation analysis of the W-CDMA terminal. In addition to the error vector magnitude (EVM) specified in the 3GPP measurement items, the phase error, amplitude error and origin offset can also be measured.



Peak code domain error

The test measures the peak code domain error of the W-CDMA terminal.

Down link RF signal generation function

The relative level of each of the CPICH^{*1}, P-CCPCH^{*2}, SCH^{*3}, PICH^{*4}, DPCH^{*5}, S-CCPCH^{*6}, and AICH^{*7} code channels can be set in the range of -30.0 to 0.0 dB. In addition, OCNS^{*8} and AWGN^{*9} are also provided, making it possible to generate any down link modulation signal required for transmitter and receiver tests. The RF output level can be set in 0.1 dB steps across a range of -140 to -10 dBm (MAIN I/O connectors)

- *1: Common Pilot Channel, *2: Primary Common Control Physical Channel, *3: Synchronization Channel, *4: Paging Indicator Channel, *5: Dedicated Physical Channel, *6: Secondary Common Control Physical Channel, *7: Acquisition Indication Channel, *8: Orthogonal Channel Noise Simulator, *9: Additive White Gaussian Noise

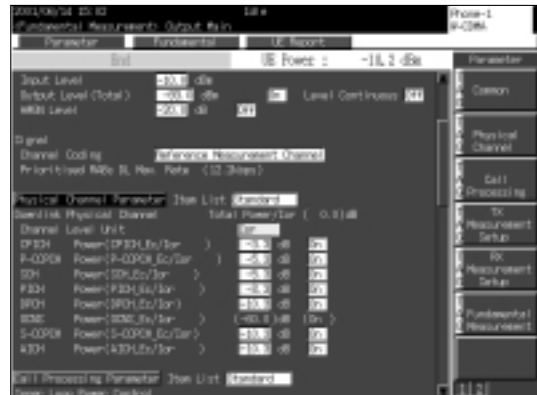

Receiver tests

Bit error rate measurement

Bit error rate can be measured by the loopback method specified in the 3GPP standards. In addition, bit error rate can also be measured by directly inputting the demodulated data and clock signals from a PDC terminal when the PDC terminal test is executed. Either PN9 or PN15 can be selected as the data pattern that is inserted in the down link RF signal.



Call processing function

Connection tests

Various connection tests such as registration, origination, termination, disconnection from terminal, disconnection from network, etc., can be performed by using the call processing function. In addition, the voice signal from the terminal can be echoed-back during conversation to perform a simple voice communications test.

Measurement results batch read command

All the results of a single batch measurement can be read using the ALLMEAS command. Specific measurement results can be selected and reported by specifying the measurement items, for example ALLMEAS MOD (for modulation analysis). The load on the GPIB bus of both the MT8820A and the host PC has been lightened by reducing the number of GPIB commands to increase throughput. Moreover, the number of steps in the control program has been reduced, making it easy to understand and easy to write comprehensive remote control programs.

Specifications

• MT8820A (main frame)

<p>General</p>	<p>Frequency range: 30 to 2700 MHz Max. input level: +35 dBm (MAIN 1) MAIN 1 I/O Impedance: 50 Ω VSWR: ≤1.2 (<1.6 GHz), ≤1.25 (1.6 to 2.2 GHz), ≤1.3 (>2.2 GHz) Connector: N type AUX 1 output Impedance: 50 Ω VSWR: ≤1.3 (at SG Output level: ≤-10 dBm) Connector: SMA type Reference oscillator Frequency: 10 MHz Level: TTL Startup characteristics: ≤±5 x 10⁻⁸ (at 10 min after startup referenced to frequency 24 h after startup) Aging rate: ≤±2 x 10⁻⁸/day, ≤±1 x 10⁻⁷/year (referenced to frequency 24 h after startup) Temperature characteristics: ≤±5 x 10⁻⁸ Connector: BNC type External reference input Frequency: 10 MHz or 13 MHz (±1 ppm) Level: ≥0 dBm Impedance: 50 Ω Connector: BNC type</p>
<p>RF signal generator</p>	<p>Frequency Frequency range: 30 to 2700 MHz (setting range: 0.4 to 2700 MHz) Setting resolution: 1 Hz Accuracy: Due to reference oscillator accuracy Output level Level range: -140 to -10 dBm (MAIN 1), -130 to 0 dBm (AUX 1) Resolution: 0.1 dB Accuracy: ±1.0 dB (-120 to -10 dBm, MAIN 1, after calibration), ±1.0 dB (-110 to 0 dBm, AUX 1, after calibration) Signal purity Non-harmonic spurious: ≤-50 dBc (offset frequency: ≥100 kHz), ≤-40 dBc [spurious of (4.8 -Fout) GHz at ≥2.1 GHz] Harmonics: ≤-25 dBc Uninterrupted level variation Variable range: 0 to -30 dB Setting resolution: 1 dB</p>
<p>Others</p>	<p>Display: Color 8.4" TFT LCD, 640 x 480 dots External control GPIB: Control from external host with main unit as device (excluding some functions such as power-on), no external device control Interface functions: SH1, AH1, T6, L4, SR1, RL1, PP0, DC1, DT1, C0, E2</p>
<p>Power supply</p>	<p>100 to 120/200 to 240 Vac (-15/+15%, 250 V max.), 47.5 to 63 Hz, ≤300 VA (with Option 01)</p>
<p>Dimensions and mass</p>	<p>426 (W) x 221.5 (H) x 498 (D) mm (excluding projections), ≤23 kg</p>
<p>Environmental conditions</p>	<p>Operating temperature and humidity: 0° to +50°C, ≤95% (no condensation) Storage temperature and humidity: -20° to +60°C, ≤95% (no condensation) EMC: EN61326: 1997/A1: 1998 (Class A), EN61000-3-2: 1995/A2: 1998 (Class A), EN61326: 1997/A1: 1998 (Annex A) LVD: EN61010-1: 1993/A2: 1995 (Installation Category II, Pollution degree 2)</p>

• Option 01 (W-CDMA measurement hardware), MX882000A W-CDMA Measurement Software

Modulation analysis	Frequency: 300 to 2200 MHz Input level: -30 to +35 dBm (MAIN) Carrier frequency accuracy: Reference oscillator accuracy + 10 Hz Modulation accuracy (residual vector error): $\leq 2.5\%$ (at input of 1-DPCCH and 1-DPDCH)
RF power	Frequency: 300 to 2200 MHz Input level: -65 to +35 dBm (MAIN) Measurement accuracy: ± 0.5 dB (-25 to +35 dBm), ± 0.7 dB (-55 to -25 dBm), ± 0.9 dB (-65 to -55 dBm) *After calibration Linearity: ± 0.2 dB (-40 to 0 dB, ≥ -55 dBm), ± 0.4 dB (-40 to 0 dB, ≥ -65 dBm) Measurement object: DPCH, PRACH
Occupied bandwidth	Frequency: 300 to 2200 MHz Input level: -10 to +35 dBm (MAIN)
Adjacent channel power	Frequency: 300 to 2200 MHz Input level: -10 to +35 dBm (MAIN) Measurement points: ± 5 MHz, ± 10 MHz Measurement range: ≥ 50 dB (at ± 5 MHz), ≥ 55 dB (at ± 10 MHz)
RF signal generator	Output frequency: 300 to 2200 MHz (1 Hz step) Channel level (CPICH, P-CCPCH, SCH, PICH, DPCH, S-CCPCH, AICh): Off, -30.0 to 0.0 dB [0.1 dB step, relative level for Ior (total level)] Channel level (OCNS): Off, Auto-setting Channel level accuracy: ± 0.2 dB (relative level accuracy for Ior) AWGN level: Off, -20 to +5 dB (0.1 dB step) AWGN level accuracy: ± 0.2 dB (relative level accuracy for Ior)
Bit error rate measurement	Functions: Insert PN9 or PN15 pattern in DTCH Measurement items: BER Measurement objective: Loop-back data imposed in up-channel, serial data input from rear-panel call processing I/O port
Call processing	Origination control: Registration, origination, disconnection from network, disconnection from mobile station (executes each processing based on 3GPP standards and performs pass/fail judgment) Mobile station control: Output level, loop-back (executes each mobile function control based on 3GPP standards)

Ordering information

Please specify model/order number, name and quantity when ordering.

Model/Order No.	Name
MT8820A	Main frame Radio Communication Analyzer
J0576B	Standard accessories Coaxial cord (N-P · 5D-2W · N-P), 1 m: 1 pc Power cord, 2.6 m: 1 pc
HB288064C5	Compact flash card: 1 pc
CA68ADP	PC card adapter: 1 pc
W1940AE	MT8820A operation manual (CD-ROM): 1 copy
MT8820A-01	Options W-CDMA Measurement Hardware
MX882000A	W-CDMA Measurement Software (requires MT8820A-01)
J0576D	Application parts Coaxial cord (N-P · 5D-2W · N-P), 2 m
J0127A	Coaxial cord (BNC-P · RG58A/U · BNC-P), 1 m
J0127C	Coaxial cord (BNC-P · RG58A/U · BNC-P), 0.5 m
J0007	GPIO connection cable, 1 m
J0008	GPIO connection cable, 2 m
MN8110A	I/O Adapter (for call processing I/O)
B0332	Extender boards (4 pcs/set)
B0333G	Rack mount kit
B0499	Carrying case (hard type with protective cover and casters)
B0499B	Carrying case (hard type with protective cover but no casters)

RADIO COMMUNICATION ANALYZER

MT8801C

300 kHz to 3 GHz

Support for CDMA, GSM, DECT, IS-136A, PDC and PHS

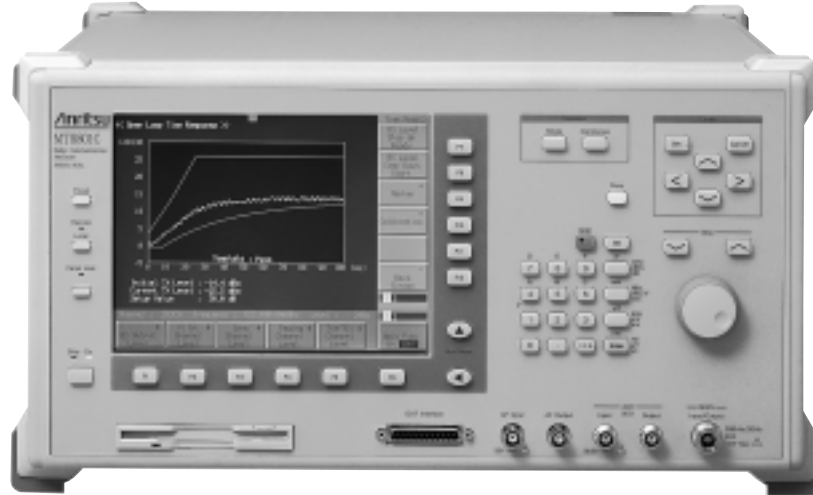

4

Every major radio communication system in the world including AMPS/PCS1900, GSM400/900/1800/1900, GPRS, HSCSD, DECT, IS-136A, PDC, and PHS can be evaluated using just one MT8801C Radio Communication Analyzer, covering the 300 kHz to 3 GHz frequency band in one hardware platform, and the dedicated measurement software options. The call processing test and sensitivity test using the loopback method are possible for GSM/DCS1800/PCS1900, CDMA, IS-136A and DECT. In addition, connection testing as well as send testing while communicating, are also possible for PDC and PHS measurement by using the call processing function, and the PDC uplink RCH can be monitored (RSSI, estimated error rate) too. FM radio transmission/reception tests are simplified by using the optional analog measurement function, and the optional spectrum analyzer function covering 10 MHz to 3 GHz is very useful for maintaining as well as measuring spurious near carrier on production lines. GPIB and RS-232C interfaces are standard, so MT8801C can be incorporated easily into automated production lines or on-site automated testing systems.

The time required for testing equipment on production lines is greatly reduced using the high-speed adjacent channel power and occupied bandwidth measurement functions based on Anritsu's proprietary measurement algorithm and DSP (Digital Signal Processing). Furthermore, major transmission test items such as transmission frequency, modulation accuracy (phase error), transmission power, rise/fall characteristics of burst wave, adjacent channel power, etc. can be measured and judged pass/fail for the limit value of each item.

Features

- 1 unit for GSM, DECT, IS-136A, PDC and PHS systems
- All basic transmission and reception measurements performed by 1 unit

System type	Measurement software option	Description
IS-136A	MX880113A	Tx and Rx measurements of IS-136A mobile stations including call processing (requires option 01)
AMPS PCS1900	MX880114A	Tx and Rx measurements of AMPS analog mobile stations and PCS1900 digital mobile telephones including call processing (requires option 01)
GSM400/900/1800/1900	MX880115A	Tx and Rx measurements of GSM and advanced GSM mobile stations including call processing and multiple timeslot measurements
PDC	MX880116A	Tx and Rx measurements of PDC mobile stations including call processing
	MX880131A	Tx and Rx measurements of PDC mobile stations

PHS	MX880117A	Tx and Rx measurements of PHS mobile stations including call processing
	MX880132A	Tx and Rx measurements of PHS base stations and mobile stations
DECT	MX880118A	Tx and Rx measurements both portable part and fixed part for DECT including call processing (requires option 07)
GSM	Option 11	Audio test of GSM mobile stations including call processing (requires MX880115A and option 01)
CDMA	Option 12	Tx and Rx measurements of mobile stations including call processing (requires option 01)

Transmission test

• Batch measurements of transmission test items

Only about 1 second is required to measure all major transmission test items, including frequency, modulation accuracy, origin offset, transmission rate, transmission power, leakage power during carrier-off, rise/fall edge characteristics, occupied bandwidth, and adjacent channel power. Pass/fail decisions for limit value of each test item can also be displayed.

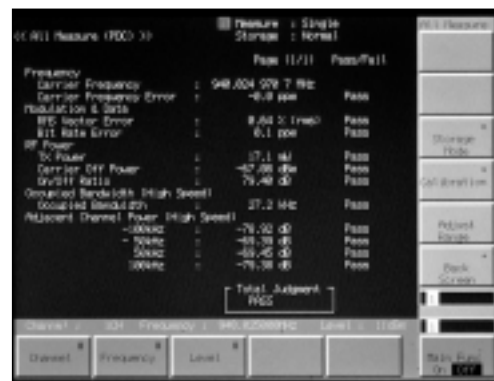

Example of linked send measurement items (PDC)

• Calibration functions

A built-in thermocouple power sensor is used for calibration, providing accurate measurement of absolute values such as average power within burst signal and leakage power during carrier-off. There is no need for other instruments; just one press of the CAL key during measurement performs calibration.

• Wide-band power meter

The power meter with built-in thermocouple power sensor can accurately measure power between 0 and +40 dBm.

• Modulation analysis

The user can display the waveform as either frequency deviation, eye diagram or constellation diagram to easily show any irregularities in the modulation.

• Measurement of antenna power rise/fall edge characteristics

Antenna power rise/fall edge characteristics can be measured simultaneously with antenna power measurements. In addition, the marker points can be moved and the power can be read directly with 1/10 symbol resolution.

• Adjacent channel power measurement

The MT8801C can measure adjacent channel power for each communication system at high speed.

• Receiver sensitivity measurement

This function displays the error count and error rate in the RF input or DATA/CLOCK input measured signal.



Bit error rate measurement (IS-136A)

• Call processing function

The MT8801C acts as a pseudo base station permitting to judge pass/fail for registration, origination, termination, communication, hand-over (PHS: TCH switching type only), disconnection from network, and disconnection from mobile station at the sequence monitor screen.

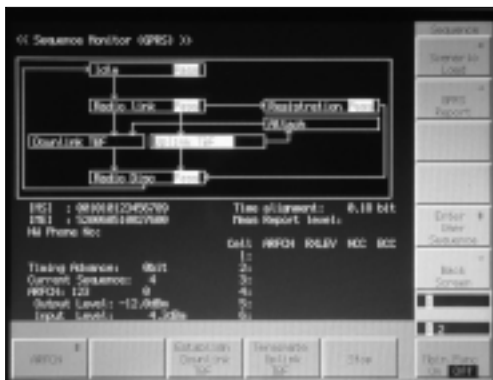

Sequence monitor display (GSMGPRS)

Analog measurement

• Analog measurement function (Option 01)

The MT8801C has general analog measurement functions too. Efficient FM TX/RX testing is made easy by built-in signal generator, AF oscillator, RF analyzer (power meter, frequency counter, FM measurement) and audio analyzer functions. This function is especially useful for the IS-136A analog test.

• Transmission measurement

Characteristics such as frequency, power, and frequency deviation can be measured easily.

• Reception measurement

An FM modulated signal is output to permit measurement of the frequency and level of the AF signal from a receiver, as well as SINAD and distortion.

Spectrum analysis

• Spectrum analyzer function (Option 07)

The spectrum analyzer with synthesized local oscillator covers a frequency range of 10 MHz to 3 GHz with a resolution of 1 Hz. In addition to a C/N of -115 dBc (100 kHz offset), the RBW can be set to 300 Hz to 1 MHz, the VBW to 3 to 100 kHz, and the sweep time in the frequency domain to 100 ms to 1000 s (1 ms to 1000 s in time domain). The total level accuracy is an astonishing ± 1.5 dB due to the analyzer's excellent linearity and the level calibration function. Moreover, the average noise level is just -85 dBm max (at 10 MHz to 1 GHz), and the secondary harmonic distortion is -60 dB max (100 MHz to 1.5 GHz).

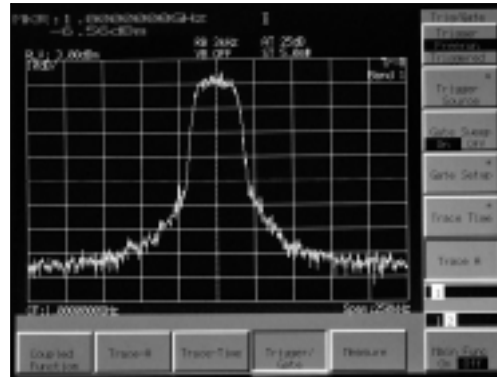

IS-136A modulated wave measurement

Options

• Option 04: AF low impedance output

This option converts the output impedance of the AF oscillator of the Option 01 analog measurement to low impedance. It permits direct driving of an external speaker connected to the AF output connector.

• Option 11: GSM audio test

When using with the MX880115A GSM Measurement Software, speech Tx/Rx characteristics can be measured in accordance with GSM Rec. RPE LTP (Full Rate Speech CODEC).

The audio signal generated by the MT8801C is digitally processed and ideal audio signal is sent. In addition, this option can also be used to digitally process an audio signal sent from a GSM terminal for high-reliability and high-accuracy measurement.

• Option 12: CDMA measurement

The Option 12 can measure the following systems; USA 800-MHz cellular band (TIA/EIA/IS-95A standard), USA 1.9 GHz PCS band (ANSI J-STD-008 standard), Japan 800-MHz cellular band (ARIB STD-T53 standard).

The CDMA and analog dual mode standardized in the IS-95A standard are supported.

Specifications

• MT8801C

Frequency range	300 kHz to 3 GHz
Maximum input level	+40 dBm (10 W, MAIN connector), +20 dBm (100 mW, AUX connector)
Input/output connector	MAIN I/O connector Impedance: 50 Ω, N-type VSWR: ≤1.2 (≤2.2 GHz), ≤1.3 (>2.2 GHz) AUX input/output connector: TNC-type
Reference oscillator	Frequency: 10 MHz Starting characteristics: ≤5 x 10 ⁻⁸ /day (after 10 minutes of warm-up, referred to frequency after 24 hours warm-up) Aging rate: ≤2 x 10 ⁻⁸ /day, ≤1 x 10 ⁻⁷ /year (referred to frequency after 24 hours warm-up) Temperature characteristics: ≤5 x 10 ⁻⁸ (0° to 50°C, referred to frequency at 25°C) External standard input: 10 MHz or 13 MHz (±1 ppm), input level: 2 to 5 Vp-p
Power meter	Frequency range: 300 kHz to 3 GHz Level range: 0 to +40 dBm, -10 to +40 dBm (CDMA measurement) Level accuracy: ±10% (0 to +40 dBm, after zero point calibration), ±10% (-10 to +40 dBm, 18° to 28°C, at average value, after zero point calibration)
Signal generator	Frequency Range: 300 kHz to 3 GHz Resolution: 1 Hz Accuracy: Reference frequency accuracy ±100 mHz Output level Level range (no modulation or analog modulation): -133 to -13 dBm (MAIN connector), -133 to +7 dBm (AUX connector) Level accuracy: ±1 dB (10 MHz to 2.2 GHz, ≥-123 dBm, 18° to 28°C), ±3 dB (10 MHz to 2.2 GHz, ≥-133 dBm), ±2 dB (>2.2 GHz, ≥-123 dBm, 18° to 28°C), ±4 dB (>2.2 GHz, ≥-133 dBm) Radiated interference: 1 μV/50 Ω (carrier frequency measured, 25 mm from front panel with two-turn 25 mm diameter loop antenna) Signal purity Spurious: ≤-50 dBc (at CW, offset frequency 100 kHz to ≤50 MHz; where carrier frequency: other than 1300 MHz to 1400 MHz and 2000 MHz to 2100 MHz), ≤-40 dBc (for all band) Harmonics: ≤-25 dBc (at CW)
Others	Display: Color TFT-LCD, 7.8 inch, 640 x 480 dots Hard copy: Enables data hard copy of the display through a parallel interface (applicable only for EPSON VP series or equivalent) GPIB: This equipment is specified as a device, can be controlled from external controller (excluding power switch and FD ejection key). No controller function Interface: SH1, AH1, T6, L4, SR1, RL1, PP0, DC1, DT1, C0, E2) Parallel Conform to the Centronics. Outputs printing data to printer. Data line exclusive for output: 8 Control line: 4 (BUSY, DTSB, ERROR, PE) Connectors: D-sub 25 pins, female (equivalent to the connector of IBM-PC/AT built-in printer) RS-232C: All functions except power switch controlled by external controller (baud rate: 1200, 2400, 4800, 9600 bps)
Dimensions and mass	426 (W) x 221.5 (H) x 451 (D) mm, ≤22 kg
Power	100 to 120/200 to 240 Vac (automatic voltage switch system), 47.5 to 63 Hz, ≤300 VA
Operating temperature	0° to 50°C
EMC	EN61326: 1997/A1, 1998 (Class A) EN61000-3-2: 1995/A2, 1998 (Class A) EN61326: 1997/A1, 1998 (Annex A)
LVD	EN610101-1: 1993/A2, 1995 (Installation Category II, Pollution degree 2)

• Option 01: Analog measurement

RF signal generator	Frequency range: 10 MHz to 3 GHz Output level range: -133 to -13 dBm (MAIN connector), -133 to +7 dBm (AUX connector) FM deviation: 0 to 40 kHz (resolution: 10 Hz) Accuracy: Set value ±5% ±1 digit (internal modulation frequency: 1 kHz, excluding residual FM) Internal modulation: 20 Hz to 20 kHz External modulation: 20 Hz to 20 kHz (limited to 1Vpeak into 600 Ω) Flatness: ±0.5 dB (referenced to 1 kHz between 0.3 to 3 kHz with 4 kHz deviation) ±1 dB (referenced to 1 kHz between 20 Hz to 20 kHz with 4 kHz deviation) Distortion: ≤-50 dB (internal modulation frequency: 1 kHz, demodulation bandwidth: 0.3 to 3 kHz, frequency deviation: 5 kHz)
AF Generator	Frequency range: 20 Hz to 20 kHz, Setting resolution: 0.1 Hz, Accuracy: Same as reference oscillator Output Level range: 0.1 mVrms to 3.0 Vrms (EMF, MAIN output impedance: 600 Ω) 0.1 mVrms to 0.3 Vrms (EMF, MAIN output impedance: 50 Ω) Setting resolution: 1 μV (output level: <4 mV), 10 μV (output level: <40 mV) 100 μV (output level: <0.4 V), 1 mV (output level: ≤3 V) Accuracy (bandwidth: <30 kHz) Unbalanced output: ±0.5 dB (frequency: 1 kHz, output level: ≥1 mV), ±1 dB (frequency: 20 Hz to 20 kHz, output level: ≥1 mV) Floating output: ±2 dB (frequency: 1 kHz, output level: ≥1 mV) Output impedance MAIN output: 600 Ω, 50 Ω selectable (unbalanced, BNC connector) DUT interface microphone output: 600 Ω, floating Distortion: <-50 dBc (bandwidth: <30 kHz, frequency: 1 kHz, output level: 1 V) <-45 dBc (bandwidth: <30 kHz, frequency: 20 Hz to 20 kHz, output level: 1 V) Noise generator: White noise passed through a weighting filter (conforming to ITU-T Rec. G.227)

Continued on next page

Transmission measurement	RF power meter	Frequency range: 300 kHz to 3 GHz Input range: 0 to +40 dBm (MAIN connector) Accuracy: $\pm 10\%$ (after zero calibration)
	IF level meter	Frequency range: 10 MHz to 3 GHz Input range: 0 to +40 dBm (MAIN connector) Accuracy: $\leq 10\%$ (after calibration with internal RF power meter) Linearity: ± 0.3 dB (0 to -30 dB)
	Frequency counter	Frequency range: 10 MHz to 3 GHz Input level range: -15 to +40 dBm (MAIN connector), -40 to +20 dBm (AUX connector) Resolution: 1 Hz Accuracy: \pm (reference oscillator accuracy + 10 Hz) Method: IF frequency counting (bandwidth: ± 30 kHz)
	Modulation	<p>FM</p> <p>Frequency range: 10 MHz to 3 GHz Input level range: -15 to +40 dBm (MAIN connector), -40 to +20 dBm (AUX connector) Filters (3 dB cut-off frequency): HPF (300 Hz, 50 kHz), LPF (3 kHz, 15 kHz) Deviation: 0 to 20 kHz Demodulation frequency: 20 Hz to 20 kHz Accuracy: 1% + residual FM (demodulation frequency: 1 kHz) Frequency response: ± 0.5 dB (referenced to 1 kHz) Residual FM: 8 Hz-rms (demodulation frequency: 0.3 to 3 kHz) Distortion: 0.3% (modulation frequency: 1 kHz, demodulation bandwidth: 0.3 to 3 kHz)</p> <p>ϕM</p> <p>Frequency range: 10 MHz to 3 GHz Input level range: -15 to +40 dBm (MAIN connector), -40 to +20 dBm (AUX connector) Filters (3 dB cut-off frequency): HPF (300 Hz, 50 kHz), LPF (3 kHz, 15 kHz) Deviation: 0 to 10 rad Demodulation frequency: 300 Hz to 3 kHz Accuracy: 1% + residual ϕM (modulation frequency: 1 kHz) Frequency response: ± 0.5 dB (referenced to 1 kHz) Residual ϕM: 0.01 rad-rms (demodulation bandwidth: 0.3 to 3 kHz) Distortion: 0.5% (modulation frequency: 1 kHz, demodulation bandwidth: 0.3 to 3 kHz, deviation: 5 rad)</p> <p>FM demodulation output</p> <p>Deviation: 0 to 40 kHz (4/40 kHz range selectable) Demodulation frequency range: 50 Hz to 10 kHz Output level: 4 V_{peak} (EMF, at full-scale range) Output impedance: 600 Ω Frequency response: ± 1 dB Distortion: 1% (FM frequency: 1 kHz, demodulation bandwidth: 0.3 to 3 kHz, frequency deviation: 4 kHz) Filters (3 dB cut-off frequency): HPF (300 Hz), LPF (3 kHz) De-emphasis: 750 μs</p>
Audio analyzer	<p>Input impedance: 600 Ω/100 kΩ selectable (unbalanced, BNC connector) Bandpass filter HPF: 400 Hz (for tone rejection) De-emphasis: 750 μs Weighting filter: ITU-T P.53, C-MESSAGE</p> <p>AF Level meter</p> <p>Frequency range: 30 Hz to 20 kHz Level range: 1 mV_{rms} to 30 V_{rms} Accuracy: ± 0.5 dB</p> <p>AF frequency counter</p> <p>Frequency range: 30 Hz to 20 kHz Level range: 30 mV_{rms} to 30 V_{rms} Accuracy: ± 0.1 Hz</p> <p>Distortion meter</p> <p>Frequency range: 100 Hz to 5 kHz Level range: 30 mV_{rms} to 30 V_{rms} Accuracy: ± 1 dB (frequency: 1 kHz, distortion factor: 1%)</p>	
Mass	≤ 500 g	

• **Option 04: AF low impedance output**

AF oscillator	<p>Output impedance*1: ≤ 1 Ω (MAIN connector, unbalanced, BNC connector) Maximum output current: ≥ 100 mA_{peak} (MAIN connector) Waveform distortion: -50 dBc (band: < 30 kHz, 1 kHz, output level: 0.3 V), -45 dBc (band: < 30 kHz, 20 Hz to 20 kHz, output level: 0.3 V)</p>
---------------	---

*1: < 1 Ω fixed (can not exchange to 50/600 Ω)

• Option 07: Spectrum analyzer

<p>Frequency</p>	<p>Band Band 0: 0 Hz to 3 GHz, Band 1: 10 MHz to 3 GHz; HPF: On/off switchable (Band 1, 1.6 to 3 GHz) Setting range 0 to 3 GHz (Band: 0), 10 MHz to 3 GHz (Band: 1); Resolution: 1 Hz Display accuracy: ± (display frequency x reference frequency accuracy + span x span accuracy) Marker frequency accuracy Normal marker: Same as display frequency accuracy; Delta marker: Same as span accuracy Span setting range: 0 Hz or 10 kHz to 3 GHz (Band: 0), 0 Hz or 10 kHz to 2.99 GHz (Band: 1) Span accuracy: ±2.5% Resolution bandwidth Setting range: 300 Hz to 1 MHz (3 dB BW, 1-3 sequence) Accuracy: ±2% (300 Hz to 300 kHz), ±10% (1 MHz) Selectivity (60 dB:3 dB): ≤5:1 Video bandwidth: 3 Hz to 100 kHz (1-3 sequence) or through *Setting range is limited by resolution bandwidth. Sideband noise: ≤-95 dBc/Hz (1 GHz, 10 kHz offset), ≤-115 dBc/Hz (1 GHz, 100 kHz offset)</p>
<p>Amplitude (band 1)</p>	<p>Maximum input level Continuous average power: +40 dBm (MAIN connector), +20 dBm (AUX connector) DC voltage: 0 V Average noise level (resolution bandwidth: 1 kHz, video bandwidth: 10 Hz) ≤-90 dBm (10 MHz to 2.2 GHz), ≤-85 dBm (>2.2 GHz) *MAIN connector input, input attenuator: 20 dB ≤-110 dBm (10 MHz to 2.2 GHz), ≤-105 dBm (>2.2 GHz) *AUX connector input, input attenuator: 0 dB Residual response: ≤-70 dBm (MAIN connector, input attenuator: 20 dB), ≤-90 dBm (AUX connector, input attenuator: 0 dB) Level accuracy ±1.5 dB (MAIN connector, reference level: +10.1 to +40 dBm, at 0 to -50 dB of reference level) ±1.5 dB (AUX connector, reference level: -9.9 to +20 dBm, at 0 to -50 dB of reference level) Reference Level Setting range: ≤-60 to +50 dBm (MAIN connector), ≤-80 to +30 dBm (AUX connector) Setting resolution: 0.1 dB Accuracy: ±0.5 dB (MAIN connector, +10.1 to +40 dBm), ±1.0 dB (MAIN connector, -60 to +10 dBm), ±0.5 dB (AUX connector, -9.9 to +20 dBm), ±1.0 dB (AUX connector, -80 to -10 dBm) *After calibration, frequency: 100 MHz, span: 2 MHz; Input attenuator, resolution bandwidth, video bandwidth, sweep time are AUTO.) Resolution bandwidth switching deviation: ±0.1 dB (resolution bandwidth reference: 3 kHz) Frequency characteristics: ±0.5 dB [100 MHz reference, input attenuation: 30 dB (10 dB for AUX input), 18° to 28°C] Log linearity: ±0.5 dB (0 to -50 dB, resolution bandwidth: ≤1 MHz), ±1.0 dB (0 to -70 dB, resolution bandwidth: ≤30 kHz), ±1.0 dB (0 to -80 dB, resolution bandwidth: ≤1 kHz) *10 MHz to 2.2 GHz, reference level: ≥0 dBm (MAIN connector)/≥-20 dBm (AUX connector) Spurious (2nd harmonic distortion): ≤-55 dBc (10 to 100 MHz), ≤-60 dBc (100 to 1500 MHz) *Mixer input: -30 dBm</p>
<p>Sweep</p>	<p>Sweep time: 100 ms to 1000 s (frequency domain sweep), 100 ms to 1000 s (time domain sweep, resolution bandwidth: ≤1 kHz) 10 ms to 1000 s (time domain sweep, resolution bandwidth: 3 to 10 kHz), 1 ms to 1000 s (time domain sweep, resolution bandwidth: ≥30 kHz) Trigger switch: FREERUN, TRIGGERED Trigger source: WIDE IF VIDEO (3 dB bandwidth: ≥20 MHz, trigger slope: RISE/FALL), EXT (trigger: TTL level, trigger slope: RISE/FALL) Trigger delay Range: 0 μs to 100 ms, Resolution: 2 μs Gate sweep Displays spectrum of input signal at specified gate on frequency domain display Gate delay: 2 μs to 100 ms from trigger start point (resolution: 2 μs) Gate width: 2 μs to 100 ms from gate delay point (resolution: 2 μs)</p>
<p>Functions</p>	<p>Marker functions Signal search: PEAK → CF, PEAK → REF Zero marker: NORMAL, DELTA Marker function: MARKER → CF, MARKER → REF, ZONE → SPAN Peak search: PEAK, NEXT PEAK, NEXT RIGHT PEAK, NEXT LEFT PEAK Measurement function Noise power: dBm/Hz, dBm/ch C/N: dBc/Hz, dBc/ch Occupied bandwidth: N% of power method, X-dB down method Adjacent channel power: Reference total power method, reference level method, channel designate display (2 channels x 2), graphic display Average power within a burst: Average power of time domain waveform within specified time</p>
<p>Others</p>	<p>Number of data point: 501 points Detector mode POS PEAK: Displays max. point between sample points, NEGATIVE PEAK: Displays min. point between sample points, SAMPLE: Displays momentary value at sample points Display memory TRACE A: Displays frequency spectrum, TRACE B: Displays frequency spectrum, Trace time: Displays time domain waveform at center frequency Storage function: NORMAL, VIEW, MAX HOLD, MIN HOLD, AVERAGE, CUMULATIVE, OVER WRITE</p>

• Option 11: GSM audio test

Tx measurement	Decoding characteristics	Frequency range: 50 Hz to 4 kHz Level range: 0 to 3.2768 V Accuracy: ± 1 Hz (500 Hz to 2 kHz)
	AF oscillator	Frequency range: 50 Hz to 20 kHz (setting resolution: 50 Hz) Accuracy: Same as reference oscillator Output level range: 50 mVrms to 3 Vrms (EMF) *Setting resolution: 0.1 mV Accuracy (bandwidth: <30 kHz) Unbalanced output: ± 0.5 dB (1 kHz, ≥ 1 mV), ± 1 dB (20 Hz to 20 kHz, ≥ 1 mV) Floating output: ± 2 dB (1 kHz, ≥ 1 mV) Output impedance Main output: 600 Ω , 50 Ω (unbalanced, BNC connector) Microphone input: 600 Ω (floating, DUT interface) Waveform distortion (bandwidth: <30 kHz): < -50 dBc (1 kHz, 1 Vrms), < -45 dBc (20 Hz to 20 kHz, 1 Vrms)
Rx measurement	Coded signal	Frequency range: 50 Hz to 4 kHz (setting resolution: 50 Hz) Level range: 0 to 2.2 V (setting resolution: 0.1 mV)
	AF level measurement	Frequency range: 30 Hz to 20 kHz Level range: 1 mVrms to 30 Vrms Accuracy: ± 0.5 dB
	AF frequency measurement	Frequency range: 30 Hz to 20 kHz Level range: 30 mVrms to 30 Vrms Accuracy: ± 0.1 Hz

• Option 12: CDMA measurement

Signal generator	Frequency range IS-95A: 869.01 to 893.97 MHz (30 kHz step) J-STD-008: 1930.00 to 1989.95 MHz (50 kHz step) ARIB STD-T53: 832.0125 to 833.9875 MHz, 843.0125 to 845.9875 MHz, 860.0125 to 869.9875 MHz (12.5 kHz step) KORER-PCS: 1805.05 to 1870.00 MHz (50 kHz step) Level setting range: -133 to -18 dBm (Main connector, AWGN off), -133 to +2 dBm (AUX connector, AWGN off) -133 to -24 dBm (Main connector, AWGN on), -133 to -4 dBm (AUX connector, AWGN on) Relative level accuracy: $\pm 0.2/20$ dB (Relative level accuracy at level change in time response of open-loop power control 18° to 28°C) Waveform quality: > 0.99 (pilot channel: 0 dB) Channel level accuracy: ± 0.2 dB (relative level accuracy between any 2 channels) AWGN level accuracy: ± 0.2 dB (relative level for forward traffic channel)
Reception measurement	FER measurement: FER measurement value, error frame number, test frame number, reliability limit (pass/fail)
Transmission measurement	Frequency range IS-95A: 824.01 to 848.97 MHz (30 kHz step) J-STD-008: 1850.00 to 1909.95 MHz (50 kHz step) ARIB STD-T53: 887.0125 to 888.9875 MHz, 898.0125 to 900.9875 MHz, 915.0125 to 924.9875 MHz (12.5 kHz step) KORER-PCS: 1715.05 to 1780.00 MHz (50 kHz step) Modulation analysis Level range: -20 to +40 dBm (average power within a burst, main connector only) Waveform quality measurement range: 0.9 to 1.0 Measurement error: ± 0.003 (after executing adjust range) Residual vector error: $< 5\%$ (after executing adjust range) Power measurement (IF level meter) Measurement range: -50 to +40 dBm Measurement accuracy: ± 0.4 dB (0 to +40 dBm, after executing power meter calibration) ± 0.4 dB (-10 to +40 dBm, after executing power meter calibration, 18° to 28°C) ± 0.7 dB (-10 to +40 dBm, after executing internal oscillator calibration, 18° to 28°C) Linearity: ± 0.1 dB (0 to -10 dB), ± 0.2 dB (-10 to -20 dB), ± 0.5 dB (-20 to -40 dB) *Referred to reference level: ≥ -10 dBm Input connector: Main connector only Occupied bandwidth measurement Level range: 0 to +40 dBm (average power within a burst, MAIN connector), -20 to +20 dBm (average power within a burst, AUX connector) Spurious close to the carrier measurement Level range: 0 to +40 dBm (average power within a burst, MAIN connector), -20 to +20 dBm (average power within a burst, AUX connector) Measurement range: ≥ 50 dB (900 kHz offset), ≥ 60 dB (1.98 MHz offset) Spurious measurement Level range: 0 to +40 dBm (average power within a burst, MAIN connector), -20 to +20 dBm (average power within a burst, AUX connector) Measurement range: ≥ 60 dB
Call processing	Functions: Registration, origination, termination, conversation, loopback, hard handoff, disconnection from network, disconnection from mobile station, CDMA \rightarrow analog handoff (IS-95A), soft handoff (MX880201A-01), softer handoff (MX880201A-01) Protocol: IS-95A (CDMA, analog), J-STD-008, ARIB STD-T53

• **MX880113A IS-136A Measurement Software (extracts)**

Transmission measurement	Digital	Frequency/modulation measurement Frequency range: 10 MHz to 2.2 GHz Modulation accuracy: \pm (2% of indicated value + 0.5%) Amplitude measurement Input level range: +10 to +40 dBm (average power within burst, MAIN connector) Transmitter power accuracy: \pm 10% (MAIN connector, after calibration) Adjacent channel power measurement Measurement range: \geq 30 dB (30 kHz offset), \geq 60 dB (60 kHz offset), \geq 65 dB (90 kHz offset) Batch measurement functions Measurement time: \leq 1.5 s (amplitude measurement in normal mode)
	Analog	Same as Option 01
Reception measurement	Digital	Signal generator Frequency range: 10 MHz to 3 GHz Level range: -133 to -13 dBm (MAIN connector), -133 to +7 dBm (AUX connector) Modulation accuracy: \leq 3%rms Error rate measurement Measurement pattern: PN9 (measures TCH data of up communication burst at RF input) Number of measurement bits: 1 to 99999999
	Analog	Same as Option 01
Call processing	Pass/fail judgement of registration, origination, termination communication, handoff, disconnection from network, disconnection from mobile station	

• **MX880114A AMPS/PCS1900 Measurement Software (extracts)**

Transmission measurement	Frequency/modulation measurement	Frequency range: 10 MHz to 2.2 GHz Residual phase error accuracy: \leq 0.5° rms, \leq 2° peak
	Amplitude measurement	Input level range: -5 to +40 dBm (average power within burst, MAIN connector) Calibration input level range: +10 to +40 dBm (average power within burst, MAIN connector) Transmission power accuracy: \pm 0.4 dB (+10 to +40 dBm), \pm 0.7 dBm (-5 to +40 dBm) *MAIN connector, after calibration by using built-in power meter with same Tx reference level as calibration
	Output RF spectrum measurement	Modulation portion measurement range: \geq 50 dB (200 kHz offset), \geq 66 dB (250 kHz offset) Transition portion measurement range: \geq 57 dB (400 kHz offset)
	All measurement items	Measurement time: \leq 2.0 s (amplitude measurement: normal mode, except MS report measurement)
Reception measurement	Signal generator	Frequency range: 10 MHz to 3 GHz Level range: -133 to -13 dBm (MAIN connector), -133 to +7 dBm (AUX connector) Phase error: \leq 1° rms, \leq 4° peak
	Error rate measurement	Measurement pattern: 10 test patterns selectable Number of measurement samples: 1 to 99999999 (FER, C1b, C1I)
Call processing	Pass/fail judgement of registration, origination, termination, communication, hand-over, disconnection from network, disconnection from mobile station	
Analog measurement	Same as Option 01 for AMPS	

• **MX880115A GSM Measurement Software (extracts)**

Transmission measurement	Frequency/modulation measurement	Frequency range: 10 MHz to 2.2 GHz Residual phase error accuracy: \leq 0.5° rms, \leq 2° peak
	Amplitude measurement	Input level range: -5 to +40 dBm (average power within burst, MAIN connector) Calibration input level range: +10 to +40 dBm (average power within burst, MAIN connector) Transmission power accuracy: \pm 0.4 dB (+10 to +40 dBm), \pm 0.7 dBm (-5 to +40 dBm) *MAIN connector, after calibration by using built-in power meter with same Tx reference level as calibration
	Output RF spectrum measurement	Modulation portion measurement range: \geq 50 dB (200 kHz offset), \geq 66 dB (250 kHz offset) Transition portion measurement range: \geq 57 dB (400 kHz offset)
	All measurement items	Measurement time: \leq 2.0 s (amplitude measurement: normal mode, except MS report measurement)
Reception measurement	Signal generator	Frequency range: 10 MHz to 3 GHz Level range: -133 to -13 dBm (MAIN connector), -133 to +7 dBm (AUX connector) Phase error: \leq 1° rms, \leq 4° peak
	Error rate measurement	Measurement pattern: 10 test patterns selectable Number of measurement samples: 1 to 99999999 (FER/CRC, C1b, C1I, FAST)
Call processing	Pass/fail judgement of registration, origination, termination, communication, hand-over, disconnection from network, disconnection from mobile station	
Analog measurement	Same as Option 01 for AMPS	

• MX880116A PDC Measurement Software with Call Processing (extracts)

Transmission measurement	Frequency/modulation measurement	Frequency range: 10 MHz to 2.2 GHz Modulation accuracy: $\pm(2\%$ of indicated value + 0.5%)
	Amplitude measurement	Input level range: +10 to +40 dBm (average power within burst, MAIN connector) Transmitter power accuracy: $\pm 10\%$ (MAIN connector, after calibration by using built-in power meter)
	Adjacent channel power measurement	Measurement range: ≥ 60 dB (50 kHz offset), ≥ 65 dB (100 kHz offset)
	Batch measurement functions	Measurement time: ≤ 1.5 s (amplitude measurement in normal mode; occupied bandwidth and adjacent channel power measurement on high-speed mode)
Reception measurement	Signal generator	Frequency range: 10 MHz to 3 GHz Level range: -133 to -13 dBm (MAIN connector), -133 to +7 dBm (AUX connector) Modulation accuracy: $\leq 3\%$ rms
	Error rate measurement	Measurement pattern: PN9, PN15 Number of measurement bits: $10^2, 10^3, 2556, 10^4, 10^5, 10^6, \infty$
Call processing		Pass/fail judgement of registration, origination, termination, communication, hand-over, disconnection from network, disconnection from mobile station

• MX880117A PHS Measurement Software with Call Processing (extracts)

Transmission measurement	Frequency/modulation measurement	Frequency range: 10 MHz to 2.2 GHz Modulation accuracy: $\pm(2\%$ of indicated value + 0.7%)
	Amplitude measurement	Input level range: +10 to +40 dBm (average power within burst, MAIN connector) Transmitter power accuracy: $\pm 10\%$ (MAIN connector, after calibration by using built-in power meter, at +10 to +40 dBm)
	Adjacent channel power measurement	Measurement range: ≥ 60 dB (600 kHz offset), ≥ 65 dB (900 kHz offset)
	Batch measurement functions	Measurement time: ≤ 1.5 s (amplitude measurement in normal mode; occupied bandwidth and adjacent channel power measurement on high-speed mode)
Reception measurement	Signal generator	Frequency range: 10 MHz to 3 GHz Level range: -133 to -13 dBm (MAIN connector), -133 to +7 dBm (AUX connector) Modulation accuracy: $\leq 3\%$ rms
	Error rate measurement	Measurement pattern: PN9, PN15 Number of measurement bits: $10^2, 10^3, 2556, 10^4, 10^5, 10^6, \infty$
Call processing		Pass/fail judgement of registration, origination, termination, communication, hand-over, disconnection from network, disconnection from mobile station

• MX880118A DECT Measurement Software (extracts)

Transmission measurement	Frequency/modulation measurement	Frequency range: 10 MHz to 2.2 GHz, RF carrier accuracy: ± 250 Hz + reference oscillator accuracy, Frequency drift measurement accuracy: ± 250 Hz, Modulation measurement accuracy: ± 10 kHz
	Amplitude measurement	Input level range: -5 to +40 dBm (MAIN connector) Calibration input level range: +15 to +40 dBm (MAIN connector) Transmitter power accuracy: ± 0.4 dB (+15 to +40 dBm), ± 0.7 dB (-5 to +15 dBm) *MAIN connector, after calibration by using built-in power meter
	Adjacent channel power measurement	Emission due to modulation: -8 dBm/160 μ W at M ± 1 , -30 dBm/1 μ W at M ± 2 , -44 dBm/40 nW at M ± 3 , -47 dBm/20 nW at M ± 4 and M ± 5 Emission due to transmitter transient: -6 dBm/250 μ W at M ± 1 , -13 dBm/40 μ W at M ± 2 , -23 dBm/4 μ W at M ± 3 , -30 dBm/1 μ W at M ± 4 and M ± 5
	All measurement items	Frequency, deviation, frequency drift, Tx power, carrier-off power, template pass/fail, timing, adjacent channel emission
Reception measurement	Signal generator	Frequency range: 10 MHz to 3 GHz Level range: -133 to -13 dBm (MAIN connector), -133 to +7 dBm (AUX connector) Modulation error: $\leq \pm 8\%$ (at 288 kHz deviation, frequency 10 MHz to 2.2 GHz)
	Error rate measurement	Modes: FER, BER (Quick Mode), BER (Full Mode) Measurement pattern: 0000111100001111, 0011001100110011, 0101010101010101, 1010 64 x 1 64 x 0 1010, pseudo-random (D-M2), ETSI patterns Number of measurement bits: 1 to 99000 k
Call processing		Bearer setup, bearer release, hand-over, loopback

• MX880131A PDC Measurement Software (extracts)

Transmission measurement	Frequency/modulation measurement	Frequency range: 10 MHz to 2.2 GHz Modulation accuracy: $\pm (2\%$ of indicated value + 0.5%)
	Amplitude measurement	Input level range: +10 to +40 dBm (average power within burst, MAIN connector) Transmitter power accuracy: $\pm 10\%$ (MAIN connector, after calibration by using built-in power meter)
	Adjacent channel power measurement	Measurement range: ≥ 60 dB (50 kHz offset), ≥ 65 dB (100 kHz offset)
	Batch measurement functions	Measurement time: ≤ 1.5 s (amplitude measurement in normal mode; occupied bandwidth and adjacent channel power measurement on high-speed mode)
Reception measurement	Signal generator	Frequency range: 10 MHz to 3 GHz Level range: -133 to -13 dBm (MAIN connector), -133 to +7 dBm (AUX connector) Modulation accuracy: $\leq 3\%$ rms
	Error rate measurement	Measurement pattern: PN9, PN15 Number of measurement bits: $10^2, 10^3, 2556, 10^4, 10^5, 10^6, \infty$

• **MX880132A PHS Measurement Software (extracts)**

Transmission measurement	Frequency/modulation measurement	Frequency range: 10 MHz to 2.2 GHz Modulation accuracy: \pm (2% of indicated value + 0.7%)
	Amplitude measurement	Input level range: +10 to +40 dBm (average power within burst, MAIN connector) Transmitter power accuracy: \pm 10% (MAIN connector, after calibration by using built-in power meter)
	Adjacent channel power measurement	Measurement range: \geq 60 dB (600 kHz offset), \geq 65 dB (900 kHz offset)
	Batch measurement functions	Measurement time: \leq 1.5 s (amplitude measurement in normal mode; occupied bandwidth and adjacent channel power measurement on high-speed mode)
Reception measurement	Signal generator	Frequency range: 10 MHz to 3 GHz Level range: -133 to -13 dBm (MAIN connector), -133 to +7 dBm (AUX connector) Modulation accuracy: \leq 3%rms
	Error rate measurement	Measurement pattern: PN9, PN15 Number of measurement bits: 10^2 , 10^3 , 2556, 10^4 , 10^5 , 10^6 , ∞

Ordering information

Please specify model/order number, name, and quantity when ordering.

Model/Order No.	Name
MT8801C	Main frame Radio Communication Analyzer
	Standard accessories
J0576B	Coaxial cord (N-P · 5D-2W · P), 1 m: 1 pc
J0768	Coaxial adaptor (N-J · NC-P): 2 pcs
	Power cord: 1 pc
F0014	Fuse, 6.3 A: 2 pcs
	Options*1
MT8801C-01	Analog Measurement
MT8801C-04	AF Low Impedance Output (requires Option 01)
MT8801C-07	Spectrum Analyzer
MT8801C-11	GSM Audio Test (requires MX880115A and Option 01)
MT8801C-12	CDMA Measurement (requires Option 01)
MX880113A	IS-136A Measurement Software (requires Option 01)
MX880114A	AMPS/PCS1900 Measurement Software (requires Option 01)
MX880115A	GSM Measurement Software
MX880116A	PDC Measurement Software with Call Processing
MX880117A	PHS Measurement Software with Call Processing
MX880118A	DECT Measurement Software (requires Option 07)
MX880131A	PDC Measurement Software
MX880132A	PHS Measurement Software
MX880201A-01	Soft Handoff (for CDMA, requires Option 12)
	Peripherals
MS8604A	Digital Mobile Radio Transmitter Tester
MD6420A	Data Transmission Analyzer
MS2683A	Spectrum Analyzer
MG3672A	Digital Modulation Signal Generator
	Optional accessories
J0127C	Coaxial cord (BNC-P · G-58A/U · NC-P), 0.5 m
J0769	Coaxial adapter (BNC-J · NC-P)
J0040	Coaxial adapter (N-P · NC-J)
MA1612A	Four-Point Junction Pad
J0395	Fixed attenuator for high power (30 dB, 30 W, dc to 9 GHz)
J0007	GPIB cable, 1 m
J0008	GPIB cable, 2 m
B0329D	Front cover (1MW 5U)
B0331D	Front handle kit (2 pcs/set)
B0332	Joint plate (4 pcs/set)
B0333D	Rack mount kit
B0334D	Carrying case (hard type, with protective cover and casters)
J0742A	RS-232C cable (for PC-98 PC, D-sub 25-pin), 1 m
J0743A	RS-232C cable (for DOS/V PC, D-sub 9-pin), 1 m

*1: Installed in Anritsu. It can be retrofitted to an already purchased MT8801C.
For details, contact your Anritsu sales representative.

W-CDMA AREA TESTER

ML8720B

2110 to 2200 MHz

For W-CDMA Base Station Area Investigation and Maintenance

NEW



The ML8720B is used for investigation and maintenance to evaluate the radio wave propagation characteristics in the area of a W-CDMA base station. When it is connected to a GPS receiver, the measured data can be correlated with positioning information (latitude and longitude).

The measurement items include functions for measuring the RSCP*1, Ec/No*2 and SIR*3, which is used to evaluate the strength of the radio wave received from each base station; and the delay profile, which is used to evaluate the delay characteristics of the radio wave caused by multipath propagation.

There are two measurement modes: the unspecified base station measurement mode, and the specified base station measurement mode. The CPICH*4 from the base station is measured in both cases. In the unspecified base station measurement mode, measurement is performed without knowing the base station scrambling code.

In the specified base station measurement mode, measurement is performed using the known base station scrambling code.

*1: Received Signal Code Power

*2: Ratio of desired receive power per chip to receive power density in band

*3: Signal Interference Ratio

*4: Common Pilot Channel

• High-speed and high-accuracy area analysis

RSCP, Ec/No and SIR can be measured at 30 cm intervals (at specified base station and single-channel measurement) while travelling at 100 km/h in a monitoring vehicle to provide fast and accurate area analysis.

• Correlation with GPS positioning data

The measured data can be correlated with GPS positioning data (latitude and longitude) and saved to a memory card. In addition, the measured data and positioning information can be downloaded at real time to an external PC via the RS-232C interface.

• High-accuracy measurement using diversity function

When used in combination with the optional diversity function, even higher-accuracy measurements, such as CPICH transmit diversity format and receive antenna diversity can be performed.

• Master/slave mode

In addition to stand-alone measurement using a single unit, several ML8720B units can be connected as one master and several slaves, permitting parallel master/slave measurements. A separate measurement channel can be specified for each ML8720B to greatly reduce the initial code detection time.

• Handy type

At only 4 kg, the ML8720B is easily portable for both outside and inside work. And the large 8.4" color LCD is easy to view.

• 3-hour battery operation

The lithium-ion battery pack provides more than 3 hours of operation and a spare battery pack solves even long-term measurement problems.

• Large-capacity memory cards

Large amounts of measured data can be saved to large-capacity flash-memory cards (256 MB max.).

Measurement examples

• Channel display

The measurement results for all the receive channels (32 max.) can be displayed simultaneously as a graph and as data. Additionally, it is possible to set measurement interval and to select the cumulative processing (max., min., median, average) for the internally accumulated data in the set measurement interval.

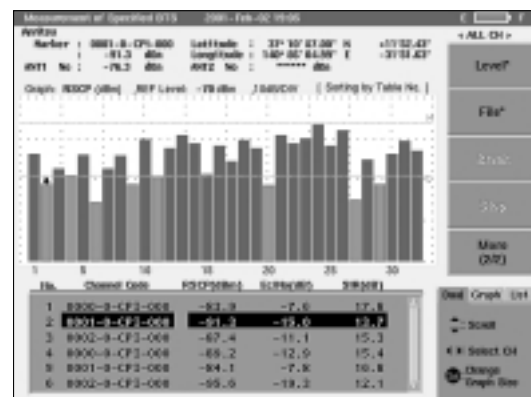

• Delay profile display

This displays the delay profile for one selected channel and the multipath can be confirmed visually. In addition, time or distance range can be selected for the horizontal axis.

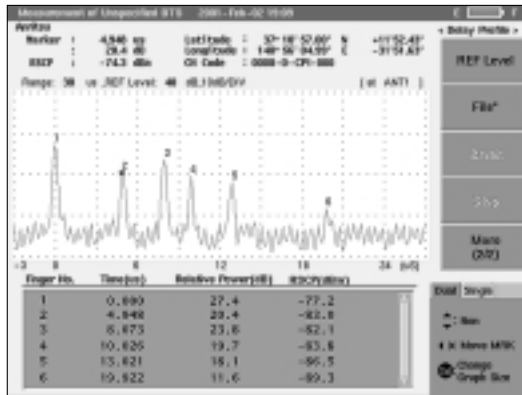

• Time/Distance variation display

A time/distance variation of the RSCP, Ec/No and SIR are displayed. The time variation can be measured in 10 ms intervals for 10 ms to 500 s and the max., min., median or average value of the cumulative totals can be displayed. The distance variation can be measured using the vehicle wheel pulse (external trigger) for 1 to 500 pulses and the max., min., median or average value of cumulative totals can be displayed.

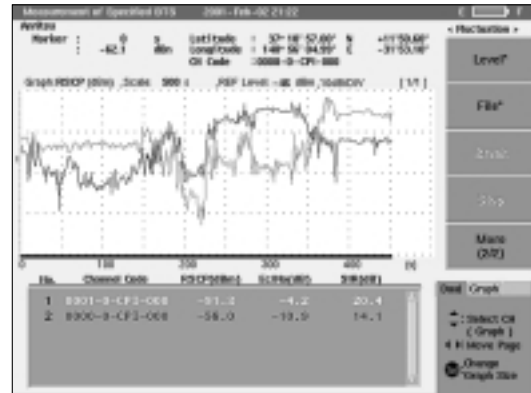

• Finger display

This displays the measured data for one selected channel path (finger).

When the diversity option is installed, the RSCP for up to 12 paths can be evaluated simultaneously.

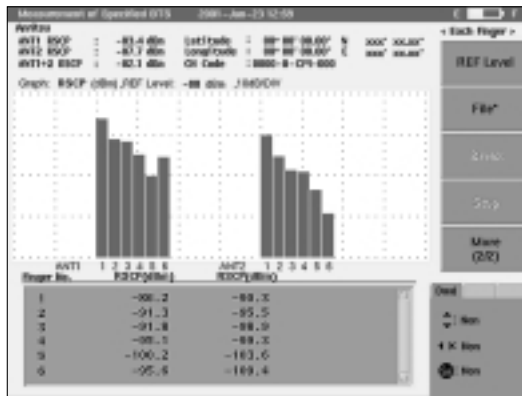

Specifications

Frequency range	2110 to 2200 MHz
Input impedance	50 Ω (SMA-type connector)
Frequency setting resolution	200 kHz (W-CDMA measurement mode), 1 kHz (spectrum monitor mode)
Reference oscillator	Aging rate: $\pm 1 \times 10^{-6}$ /year
Receive signals	P-CPICH, S-CPICH
Power measurement	Measurement range W-CDMA measurement mode: -117 to -33 dBm Spectrum monitor mode: -123 to -33 dBm Resolution: 0.1 dB Display units: dBm, dBμV, dBμV/m (spectrum monitor mode) Accuracy: ± 2 dB (RSCP) Average noise level (spectrum monitor mode): ≤ -127 dBm (RBW: 4 kHz) SIR Accuracy: ± 3 dB (at dynamic range: -100 to -40 dBm, SIR: 5 to 20 dB) Dynamic characteristics: RSCP, SIR measurement at 0 to 100 km/h (averaged distance: 50 m)
Measurement items	Specified base station, unspecified base station, spectrum monitor
Base station measurement	Measurement items: Received signal code power (RSCP), ratio of desired receive power per chip to receive power density (Ec/No), signal interference ratio (SIR) Measurement modes: Time variation (internal trigger) distance variation (external trigger) Sampling interval: 10 ms min. (at 1 channel measurement) Measurement channels: 32 max. Sync acquisition time: 600 ms x the number of search channel Data processing method: Average, median, max., min., 10%, 20%, 30%, 40%, 60%, 70%, 80%, 90% Measurement displays: All channel, delay profile, each finger, fluctuation (fluctuation is only for specification base station measurement)
Spectrum monitor function	Frequency span: 4 MHz, 90 MHz Resolution bandwidth: 4 kHz

Continued on next page

Other functions	Master/slave function: Daisy chain of multiple ML8720B, parallel measurement GPS connection: Supports NMEA-0183 format Remote control: Via RS-232C File I/O: Read measurement conditions, output measured results file Diversity function: Transmit diversity, receive antenna diversity (Option 01)
Interface	IF output: ≥ 10 dB μ V (190 MHz), BNC connector External reference input: 2 to 5 Vp-p (10 MHz), BNC connector External trigger input: 1.5 Vdc \pm (2 to 13 Vp-p), BNC connector Sync output: TTL level, BNC connector RS-232C-1: For external computer (max. 115.2 kbps), D-sub 9-pin connector RS-232C-2: For GPS (supports NMEA-0183 format), mini-DIN 8-pin connector Printer: 8-bit parallel I/F (conform to Centronics), D-sub 25-pin connector Keyboard: Mini-DIN 6-pin connector External monitor: VGA, mini-DIN 10-pin connector
Storage media	FDD (3.5", 2HD), ATA flash card
Display	640 x 480 dots, 8.4" color LCD
Environment conditions	Temperature and humidity: 0° to +40°C/ $\leq 85\%$ (operating), -25° to +60°C/ $\leq 85\%$ (storage) Vibration: MIL-T-28800E Class 3 Drop test: 76 cm drop (Bellcore standard) EMC: EN61326 (1997/A1, 1998) Class A, EN61000-3-2 (1995/A2, 1998) Class A, EN61326 (1997/A1, 1998) Annex A LVD: EN61010-1 (1993/A2, 1995) Installation Category II, Pollution degree 2
Power	10 to 26.4 Vdc 100 to 240 Vac, 50/60 Hz (with AC adapter) Battery: Z0404A Lithium Ion Battery Pack Power consumption: 35 W max., 20 W (typical), 30 W (typical with Option 01) Battery continuous operation time: 3 h (typical), 2 h (typical with Option 01)
Dimensions and mass	290 (W) x 194 (H) x 78 (D) mm, ≤ 4 kg (with battery pack) 290 (W) x 194 (H) x 123 (D) mm, ≤ 5 kg (with Option 01 and battery pack)

Ordering information

Please specify model/order number, name and quantity when ordering.

Model/Order No.	Name
ML8720B	Main frame W-CDMA Area Tester
W1893AE	Standard accessories ML8720B operation manual: 1 copy
Z0404A	Lithium Ion Battery Pack: 1 pc
J1069	AC adapter: 1 pc
	Power cord: 1 pc
Z0402A	Protective cover: 1 pc
Z0403A	Belt with hook: 1 pc
Z0516	Antenna: 1 pc
Z0517	Antenna mount (with 5 m cable): 1 pc
ML8720B-01	Option Diversity function
ML8720B-90	Maintenance service Extension service 3 years
ML8720B-91	Extension service 5 years
ML8720B-96	Extension service 3 years (with Option 01)
ML8720B-97	Extension service 5 years (with Option 01)
JT128MA3-NT1	Application parts PC-ATA card (128 MB)
JT256MA3-NT1	PC-ATA card (256 MB)
Z0436	Hard carrying case
Z0435	Soft carrying case [430 (W) x 300 (H) x 170 (D) mm]
B0442	Soft carrying case [440 (W) x 310 (H) x 110 (D) mm]
Z0526	Case for installation (for main frame)
J0127D	BNC cable (for external trigger connection)
J0654A	Serial interface cable (for connecting IBM-PC/AT)
J0977	Serial interface cable (for connecting GPS)
J0978	VGA conversion cable (for connecting external monitor)

RADIO COMMUNICATION TEST SYSTEM
ME7812 Series

Low-Cost Automatic Test System for cdmaOne/PDC/PHS Mobile Stations



GPIB

4

The ME7812 series test system is for automatic testing of cdmaOne mobile station for both the Japanese ARIB system and the North-American IS-95 system and PDC/PHS mobile stations. It can also be used for testing dual mode stations of the North-American AMPS (analog) and cdmaOne.

The test method can be selected from the IS-95A, J-STD-008, ARIB STD-T53 KOREA-PCS (cdmaOne), RCR STD-27 (PDC) and RCR STD-28 (PHS) standards, the TELEC Technical Standard Conformity Certification, and a high-speed method.

A full range of options permits the test system to be configured for both production lines and specific applications. A personal computer running Windows 98 can be used as a system controller.

Models	Application systems
ME7812A	cdmaOne
ME7812B	cdmaOne, PDC
ME7812C	cdmaOne, PHS
ME7812D	cdmaOne, PDC, PHS
ME7812E	PDC
ME7812F	PHS
ME7812G	PDC, PHS

Features

- Standards-based measurement
- Easy-to-understand GUI operations and help guide

Functions and performance

• LAN connection, data collection and system management

A network of plural test systems can be constructed easily using the Windows 98 Network Drive Assignment function. The test conditions and data can be saved into a server*1. In addition, network construction services are supported.

*1: Requires LAN card in PC

• Automatic correction of frequency characteristics

The I/O frequency characteristics of the test system with the options must be corrected. The MX781250A Level Correction Software measures the correction data automatically. Maintenance and periodical updates are made easily using these corrected frequency characteristic values. I/O level errors can be detected by comparing the current and previous corrected values.

• Switching unit for continuous tests

The ME7411A Switching Unit for Transceiver Continuous Test is used for testing two mobile stations alternately. It eliminates the time required to change mobile stations, allowing continuous testing*2.

*2: The ME7410A or ME7413A switches the RF signals.

• Compact high-performance coaxial switch

The ME7413A Coaxial Switch can be connected directly to the RF I/O connector of the MT8801B/C and MT8802A. It is especially suitable for maintenance of mobile stations. The power is supplied and controlled from the controller.

• For maintenance of mobile stations

Call processing allows PDC, PHS, and cdmaOne mobile stations to be tested in the actual operation conditions (communication mode). Communication test is also possible.

• High-speed measurement

TELEC Technical Standard Conformity Test items, such as frequency, transmission rates, antenna power, carrier-off leakage power, occupied bandwidth, adjacent channel power, spurious emissions and radiated spurious emissions can be measured for PDC/PHS in less than 30 seconds.

- **Test by call processing or test mode control**

Any frequency channel (L, M, H, ALL) can be selected for each test item of call processing or test mode control. The selected items can be tested continuously.

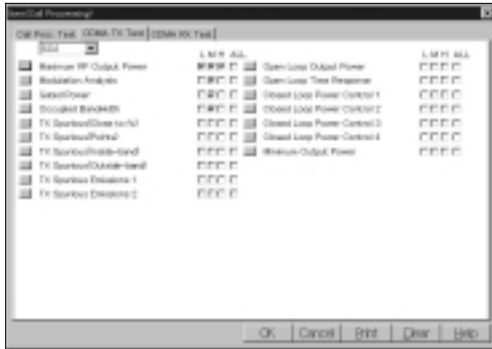

- **Flexible tests with various parameters**

Specifications and average, etc., parameters can be set for each test item, providing optimum test conditions suitable for the mobile station model or test purpose.



- **Free choice of system components**

System components can be chosen to match the required functions. For example, a signal generator can be chosen for 3-signal application.

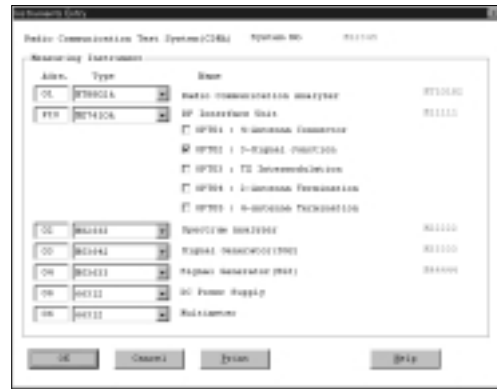

- **Help guide**

A help guide supports the software products. Either Japanese help guide or the English help guide (only for cdmaOne) can be selected at installation.

- **Example of test data output**

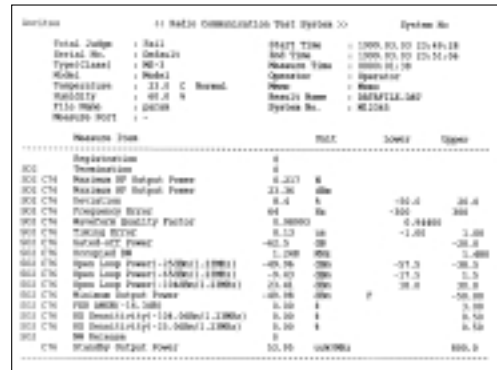

Data printout

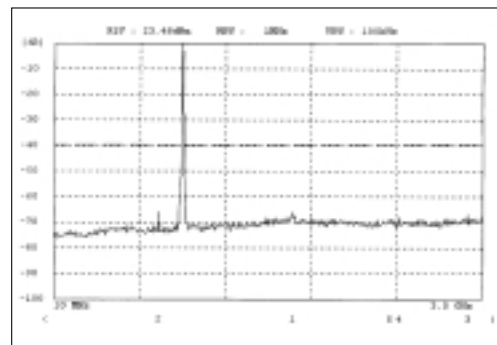

Graphical data printout

Only cdmaOne graphical data can be saved on disk.

Test items (For system construction, please refer to the individual data sheet.)

• ME7812A/B/C/D

Measurement items	System	cdmaOne		
	Options	Standard	Option 03/13	Option 04
CDMA TX tests	Maximum RF output power	●		
	Frequency error	●		
	Waveform quality factor	●		
	Transmit time error	●		
	Gated output power	◆		
	Occupied bandwidth	●		
	TX spurious (close to fc) at maximum RF output power	●		
	TX spurious (points) at maximum RF output power	●		
	TX spurious (inside-band) at maximum RF output power		●	
	TX spurious (outside-band) at maximum RF output power		●	
	TX spurious emissions		●	
	Open loop output power	■		
	Time response of open loop power control	■		
	Range of closed loop power control	■		
	Minimum controlled output power	●		
	Stand-by output power	■		
	Access probe output power	■		
CDMA RX tests	Demodulation of forward traffic channel in AWGN	■		
	Receiver sensitivity and dynamic range	■		
	Single tone desensitization			■
	Intermodulation spurious response attenuation			■
	RX spurious emissions		●	
Analog TX tests	RF frequency error	◆		
	RF output power	◆		
	Compressor	◆		
	Transmit electrical audio response	◆		
	Modulation deviation limiting	◆		
	SAT	◆		
	SA	◆		
	FM hum and noise	◆		
Modulation distortion	◆			
Analog RX tests	RF sensitivity	◆		
	RSSI	◆		
	Electrical audio frequency response	◆		
	Audio muting	◆		
	Expander	◆		
	Hum and noise	◆		
	Audio harmonic distortion	◆		
Call processing test	CDMA origination and termination	■		
	Voice test	■		
	CDMA-to-analog hand-off	■		
	Analog origination/release	■		
DC test*1	Current consumption	●		

● : Tests with call processing and test mode control

■ : Test with call processing

◆ : Test with test mode control

*1: A DC power supply and a multimeter are required.

• ME7812B/D/E/G

Measurement items	System	PDC					
	Software	MX781217A (with processing)			MX781232A		
	Options	Standard	Option 03/13	Option 04	Standard	Option 03/13	Option 04
TX tests	Frequency error	●			◆		
	Modulation accuracy	●			◆		
	Transmission rate	●			◆		
	Antenna power deviation	●			◆		
	Leakage power during carrier-off	●			◆		
	Burst transmission transient response characteristics	●			◆		
	Occupied bandwidth	●	●		◆	◆	
	Adjacent channel power	●	●		◆	◆	
	Transmission timing	■			◆		
	Spurious emission strength		●			◆	
	Transmission intermodulation				◆*2		◆*2
	Transmission output control characteristics	●			◆		
	Time alignment	■					
RX tests	Receiver sensitivity	◆			◆		
	Bit error rate floor characteristics	◆			◆		
	Interference level			◆			◆
	Adjacent channel selectivity			◆			◆
	Intermodulation characteristics			◆			◆
	Spurious sensitivity			◆			◆
	Receiver level detection	●			◆		
	Network quality detection	●			◆		
Secondary emission strength		◆			◆		
Call processing test	Origination/termination disconnection	■					
	Voice test	■					
DC test*1	Current consumption	●			◆		

- : Tests with call processing and test mode control
- : Test with call processing
- ◆ : Test with test mode control

*1: A DC power supply and a multimeter are required.

*2: ME7410A-03 and ME7812B/C/D-03 are required.

• ME7812C/D/F/G

Measurement items	System	PHS					
	Software	MX781217A (with processing)			MX781232A		
	Options	Standard	Option 03/13	Option 04	Standard	Option 03/13	Option 04
TX tests	Frequency error	●			◆		
	Modulation accuracy	●			◆		
	Transmission rate	●			◆		
	Antenna power deviation	●			◆		
	Leakage power during carrier-off	●*2			◆*2	◆	
	Burst transmission transient response characteristics	●			◆		
	Occupied bandwidth	●	●		◆	◆	
	Adjacent channel power	●	●		◆	◆	
	Transmission timing	■			◆*4		
	Spurious emission strength		●			◆	
	Transmission intermodulation				◆*3		◆*3
	Transmission output control characteristics	◆			◆		
2 signal 3rd order distortion					◆*4		
RX tests	Receiver sensitivity	◆			◆		
	Bit error rate floor characteristics	◆			◆		
	Interference level			◆			◆
	Adjacent channel selectivity			◆			◆
	Intermodulation characteristics			◆			◆
	Spurious sensitivity			◆			◆
	Receiver level detection	◆			◆		
	Network quality detection						
Secondary emission strength		◆			◆		
Call processing test	Origination/termination disconnection	■					
	Voice test	■					
DC test*1	Current consumption	●			◆		

- : Tests with call processing and test mode control
- : Test with call processing
- ◆ : Test with test mode control
- *1: A DC power supply and a multimeter are required.
- *2: High-speed method only
- *3: ME7410A-03 and ME7812B/C/D-03 are required.
- *4: PHS base station (CS) test only

W-CDMA Virtual Signaling Tester (VST), MX785101A,

W-CDMA Protocol Test System (PTS) MX785201A



The MX785101A VST (Virtual Signaling Tester) and MX785201A PTS (Protocol Test System) is a family of test and verification tools from Anritsu for next generation wireless products. They have been developed to provide the test support today's research and development engineers need to successfully meet demanding performance and time to market targets.

They provide a common user interface thus reducing operator learn time as development progresses and migrates over the range of Anritsu's 3G development tools.

In addition, test procedures generated for the PTS can be run on the VST and vice versa. This enables test procedures to be developed very early in the development cycle and to evolve as the user equipment evolves. A substantial saving in the investment in development of test procedures can be realized.

Features

- W-CDMA protocol test capability
- 3GPP Standard compliant development tool
- Common user interface across Anritsu development tools
- Comprehensive on-line help
- Environment supporting TTCN test case execution
- TTCN test procedure library available
- Re-use of test cases on VST (Virtual Signaling Tester) and PTS (Protocol Test System)

MX785201A

The MX785201A PTS software is combined with the MD8480A W-CDMA Signaling Tester to make a system providing an environment to exercise Layer 3 and Layer 2 signaling protocols defined within the Third Generation Partnership Project (3GPP).

The PTS and VST software component runs on a Windows 95/NT™ PC. They execute TestStand™ test sequences made up of calls into a library of TTCN test cases through which can be defined:

- Sequences of layer 3 messages and expected responses
- Layer 3 to layer 2 service primitives to trigger specific layer 2 procedures, or to configure layer 2 operation

- Layer 3 to layer 1 service primitives to configure and initiate layer 1 operation
- Service primitives to and from user provided code modules for UE control

The layer 2 protocol stack and layer 3 test tools are functionally equivalent to those used in the Anritsu VST (Virtual Signaling Tester). An application-programming interface (API) to enable user generated C-language test scenarios to be executed is available for the PTS.

MX785101A

The MX785101A VST software provides an environment to exercise Layer 3 and Layer 2 signaling protocols defined within the Third Generation Partnership Project (3GPP). When linked to the customer's signaling protocol development environment, Layer 3 and Layer 2 Test Procedures running on the VST platform enable verification and subsequent validation of the signaling protocol Software Under Test.

The VST executes on a standard Windows PC. The SUT (Software Under Test) may reside on any machine that can be connected via a TCP/IP port to the Windows PC running the VST. In order to interface to the VST, the User Equipment (UE) abstract layer 1 and UE adapter software components are required for the Software Under Test. The VST Network (NW) abstract layer 1 and adapter components can be used as a starting point to develop these components. The Abstract Layer 1 has also been developed in such a way that users can easily customize it in order to simulate specific features of the air interface.

Evolution with 3GPP

The capability of the VST & PTS will evolve and additional capability added in-line with the 3GPP specifications. When available, the PTS will run the 3GPP Conformance Test Suite as defined in TS34.123.

In addition, the Protocol Test System will support the layer 1 and layer 2 parameter sets defined in the 3GPP specifications TS34.108.

System overview

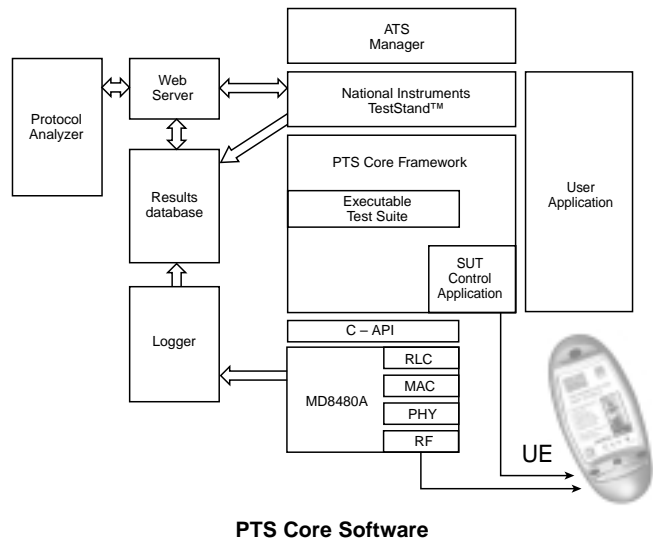

ATS manager



The ATS Manager provides a user interface which allows configuration of the MX785201A PTS, launch of the test sequencer tool to select and execute pre-prepared Layer 3 and Layer 2 Test Procedures and browse the results of the Test Procedures using the Protocol Analyzer.

Protocol Analyzer

All Layer 3, Layer 2 and Layer 1 message exchanges between the MX785201A PTS and the System Under Test are logged. These messages are decoded to show the name and content of each field and displayed using the Protocol Analyzer. Raw captured data is displayed in hexadecimal format.

National Instruments TestStand™

The MX785201A PTS uses the National Instruments TestStand™ run-time engine as a high level sequencing tool. The TestStand™ development system is used to create test sequences.



C-API

As an alternative language to develop Layer 3 and Layer 2 Test Procedures, a 'C' based Application Programmer's Interface (C-API) is included in the form of a DLL.

Executable test suite

Layer 3 and Layer 2 test cases are implemented using TTCN (Tree and Tabular Combined Notation). Created TTCN tests are compiled to an Executable Test Suite (ETS) which interfaces to the MX785201A PTS via the GCI Management Interface and the GCI Operational Interface. These provide an open, standardized interface to TTCN based executable test suites. The MX785201A PTS has been developed to work with the Telelogic Test Suite TTCN Browser tool. The GCI framework provided by the MX785201A PTS provides support for a number of Test Suite Operations (TSOs) and also Protocol Implementation Conformance Statement (PICS/PIXIT).

Codec

The ETS is supported by a codec capable of encoding and decoding Radio Resource Control (RRC), Non Access Stratum (NAS) and lower layer configuration data.

Thin RRC

A thin RRC is provided to load NAS messages into RRC direct transfer messages and unload NAS messages from RRC direct transfer messages transparently.

SUT Control Application

The MX785201A PTS frame-work provides an API to support automatically communicating with the UE to replace keyboard or internal (to UE) signals.

Logger and Results Database

The logger captures data from the majority of components in the system and stores it in the Results Database. This data is used by the Protocol Analyzer to create message sequence charts and display decoded messages.



RLC and MAC

RLC and MAC layers conforming to the 3GPP specifications TS25.322 Radio Link Control Protocol Specification and TS25.321 Medium Access Control Specification are supplied as part of MD8480A.

TE (Terminal Equipment)

The TE is an optional software component available as part of the MD8480A in the MX785201A PTS. It supports a number of features including voice AMR 12.2K Codec, ISDN, IP and PPP.

Layer 1

The MX785201A PTS provides a physical layer 1 through the MD8480A that can communicate with a terminal.

Simple installation

The distribution software set is provided on CD-ROM with a self-contained installation program.

The installation process is straightforward and the user is guided through the process using self-explanatory prompts. The PTS Quick Start Guide details the installation procedure and information about the hardware setup requirements.



Libraries available

Integration libraries

Integration libraries provide a proven set of test scripts that have been tested on real terminals. These test cases take the user through specific milestones (e.g. RRC Connection, location update, voice call, etc.) and provide a straightforward method for testing of terminals during the integration process. They provide a step by step test approach to prove functionality in a UE.

Executable TTCN Integration Library

The Test Procedures are 3GPP compliant and are designed to be customized to the particular needs of an Integration environment. The PTS Integration Library provides TestStand[®] Sequences in an executable form of the TTCN test cases. National Instruments TestStand[™] is required to implement these cases. TTCN Integration Library Source Code

This Library includes the source code for the Test Procedures and TestStand[®] sequences included in MX785201A-30. This will allow more experienced users to make changes to the parameters in order to test more specific details of the terminal design.

R&D libraries

R&D libraries provide more flexible test capability and allow experienced designers to exercise their terminals beyond the requirements of 3GPP. These libraries will become available in executable form and as source code as the standards evolve.

Ordering information

Please specify model/order number, name and quantity when ordering. For full information please request the MX785101A or MX785201A data sheet.

Model/Order No.	Name
MX785101A	VST Core Software Single Cell ETS Framework
	Libraries
MX785101A-30	Executable TTCN Integration Library
MX785101A-31	TTCN Integration Library Source Code
Note:	For latest information on options and libraries available, please refer to your local Anritsu sales office
	Support
MX785101A-01	National Instruments TestStand [™]
MX785101A-20	Software Update and Maintenance Contract
MX785101A-21	Training Course (2 days)
MX785101A-22	Premium Support (per day)
MX785101A-23	Installation & Commissioning (1 day)

Conformance libraries

These libraries currently are being written by 3GPP and when they are available they will be the authority for 3GPP conformance. These libraries are expected to change as the 3GPP specifications are refined. Anritsu will provide the latest versions available and for those users within the support scheme, the libraries will be updated regularly.

The PTS is intended to evolve along with 3GPP specifications and terminal capability. Version 2.0 is planned to evolve as shown in the timeline below.

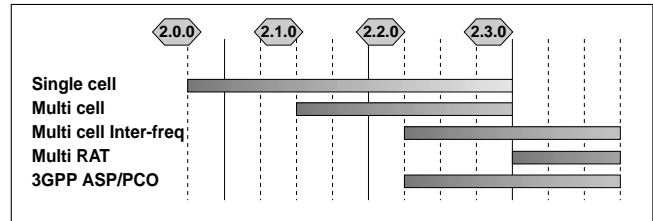

Copyright © 1995 –1999 The Apache Group. All rights reserved.
 "This product includes software developed by the Apache Group for use in the Apache HTTP server project
 Copyright © 2000 National Instruments Corporation. All rights reserved. All contents and trademarks © 2001 PTS Plc/GLOBETrotter software Inc. All rights reserved.
 (<http://www.PTS.co.uk>)

Model/Order No.	Name
MX785201A	PTS Core Software Single Cell ETS Framework
	Options
MX785201A-30	Executable TTCN Integration Library
MX785201A-31	TTCN Integration Library Source Code
Note:	For latest information on options and libraries available, please refer to your local Anritsu sales office
	Support
MX785201A-01	National Instruments TestStand [™]
MX785201A-20	Software Update and Maintenance Contract
MX785201A-21	Training Course (2 days)
MX785201A-22	Premium Support (per day)
MX785201A-23	Installation & Commissioning (1 day)

MEASURING RECEIVER

ML5655C

1.4 to 1.55 GHz

For Measuring Field Strength of Digital Cellular Phones and MCA Systems



**GPIB
OPTION**

Recent radio communication systems such as the Personal Digital Cellular and MCA require high-speed and multichannel field strength measurements. The ML5655C Measuring Receivers meet these requirements and can be used as part of a mobile system for measuring radio wave propagation characteristics.

Applications

- Automatic radio wave propagation measurement system
- Radio wave propagation characteristics measurement system

Features

- 1 ms sampling rate
- 10%, 50%, 90% values calculation
- Measuring transmitter spurious, and measuring low-level signals in R&D and production
- Portable design

ERROR RATE TESTER

MP1201C

40 Hz to 1.2 MHz

For R&D, Manufacturing and Maintenance of Digital Systems



CE

The MP1201C is a compact, easy-to-use tester operating at a clock frequency of 40 Hz to 1.2 MHz. It is composed of a separate transmitter and receiver; the transmitter sends an M-series pseudo-random signal similar to that of an actual circuit, and the receiver displays the error rate of measured signals using LEDs. A GPIB is provided as standard equipment. In addition to measuring the reception sensitivity of digital radio systems and the bit error rate of digital transmission systems, the MP1201C is ideal for systems R&D, manufacturing, and maintenance.

Features

- Bit error rate and error pulse count measurement
- Pseudo-random (PN9, PN15) and fixed (1010...) pattern measurement
- Error insertion
- Auto sync on/off
- Printer output

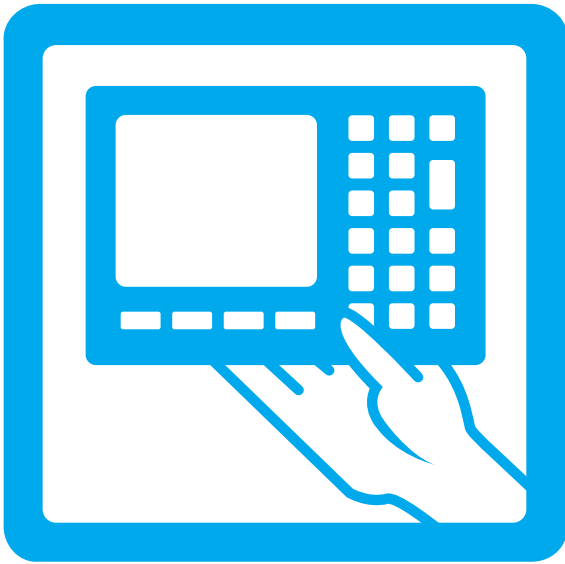

HANDHELD MEASURING INSTRUMENTS

Cable Mate	292
HandHeld Spectrum Analyzer	294
Site Master	297

CABLE MATE

C751, C752

5 to 1000 MHz 5 to 1200 MHz

For Accurate Return Loss/SWR Measurements

The Cable Mate is a precision hand held return loss/SWR and fault location measurement instrument. Built-in fault location and wattmeter capabilities are available if required, allowing users to configure Cable Mate to meet their specific need. It's lightweight, rugged design, and wide temperature range make it ideal for field applications. Cable Mate's frequency domain reflectometry technique allows it to find problems before they became catastrophic faults. Advanced features such as distance-to-fault windowing functions are incorporated in the Cable Mate design.

Cable Mate Software Tools is a free software program provided with every Cable Mate unit. It provides many useful features including a database for Cable Mate measurements, Smith chart display of S11, "drag-n-drop" overlay for measurement comparison, capability to download data to a PC, and distance-to-fault calculation from return loss or SWR plots. Advanced printing capabilities are provided by Cable Mate Software Tools, including user definable plot scaling and a multiple plots per page option.

Cable Mate assures that coaxial lines have been installed properly. Subsequent use of Cable Mate allows maintenance technicians to find and verify problems quickly. The Bandwidth of in-house wiring can be verified from outside. Advanced techniques can identify the presence of unauthorized cable boxes.

Cable Mate is designed for field requirements. Its rugged construction survives rough field treatment. Battery power, light weight, small size, wide temperature range, and simple user interface are exactly what cable television technicians want today. Cable Mate is the best solution for coaxial line installation and maintenance.

Features

- Accurate return loss/SWR measurements
- Built-in distance-to-fault (C752 model only)
- Distance-to-fault windowing functions
- Cable insertion loss test
- Optional wattmeter
- Synthesizer accurate to 75 ppm
- 10 kHz resolution
- Internal memory saves up to 40 traces, 2 calibrations and 9 setups
- Direct printing via RS-232 serial port
- Remote operation via RS-232 serial port

Applications

- Cable television
- 75 Ω coaxial cable systems

Specifications*1

Model	C751	C752
Frequency range	5 to 1000 MHz	5 to 1200 MHz
Frequency accuracy	CW mode: 75 ppm	
Frequency resolution	10 kHz	
Immunity to interfering RF signals up to*2	+10 dBm	
Return loss	Range: 0 to 54 dB, Resolution: 0.01 dB	
SWR	Range: 1 to 65, Resolution: 0.01	
Distance-to-fault	–	Vertical range Return loss: 0 to 54 dB SWR: 1 to 65 Horizontal range (meter): 0 to 128 x resolution Horizontal resolution, rectangular windowing resolution (meter): $1.5 \times 10^8 (V_p)/\Delta \text{ frequency}^{*3}$
Wattmeter (RF power monitor) option	Display range: –80 to +80 dBm, 10 pW to 100 kW Detector range: –50 to +20 dBm, 10 nW to 100 mW Offset range: 0 to +60 dB Resolution: 0.1 dB, 0.1 W	
Cable insertion loss	Range: 0 to 20 dB, Resolution: 0.01 dB	
Test port connector	Precision N female, 75 Ω	
Maximum input without damage	N (f) test port: +22 dBm RF power detector: +20 dBm, 75 Ω	
Trace memory	40	
Instrument configuration	9	
Calibration memory	2	
Temperature	Operating: 0°C to +50°C Storage: –20°C to +75°C	
Weight	1.14 kg (2.5 lbs.) nom	
Size	203.2 mm x 177.8 mm x 57.2 mm (8 in x 7 in x 2.25 in)	
General	Electromagnetic compatibility: Meets European community requirements for CE marking RS232: 9-pin, D-sub, three wire serial	

*1: All specifications apply when calibrated at ambient temperature after a five minute warm up.

*2: Immunity performance is represented for a typical worst-case condition. Measurements were made in CW mode by injecting a signal into the Cable Mate through a coupler with the same signal injected through the coupled arm. In field applications, signals are modulated and varying in frequency rather than CW. Immunity is typically better when swept frequencies are used.

*3: Where V_p is the cable's relative propagation velocity. Δ frequency is the stop frequency minus the start frequency (in Hz). Wide frequency sweeps improve resolution but reduce maximum display range.

Ordering information

Please specify model/order number, name, and quantity when ordering.

Model/Order No.	Name
C751 C752	Main Frame Site Master (5 to 1000 MHz) Site Master (5 to 1200 MHz), built in DTF
CM/STS CM/STL 2300-211 10580-00011 10580-00013 D41955 40-74 806-62 800-411	Standard accessories N type, standard short (75 Ω) N type, standard load (40 dB, 75 Ω) Cable mate software tools Cable mate operating manual Cable mate programming manual Soft carrying case AC-DC adapter Automotive cigarette lighter/12 Volt DC adapter Serial interface cable
Option 01	Options Switch standard calibration components to precision N components
Option 05	RF watt meter power monitor (5 to 1200 MHz, RF detector not included)
1091-136 1091-137 1091-168 1091-169 15NNF75-1.5A	Optional accessories Precision adapters, DC to 1.5 GHz, N (f)/F (f), 75 Ω Precision adapters, DC to 1.5 GHz, N (f)/F (m), 75 Ω Precision adapters, DC to 1.5 GHz, N (m)/F (m), 75 Ω Precision adapters, DC to 1.5 GHz, N (m)/F (f), 75 Ω Test port cable armored, 1.5 meter, N (m) to N (f), 75 Ω , 1.2 GHz Detector extender cable 7.6 m (25 ft.) Detector extender cable 15.2 m (50 ft.) Detector extender cable 30.5 m (100 ft.) Detector extender cable 61 m (200 ft.) RF detector, 5 to 1200 MHz, N (m), 50 Ω , 75 Ω Transit Case
800-109 800-110 800-111 800-112 5400-71N75L 760-215A 2000-766	HP deskjet printer (includes: serial-to-parallel interface cable, black print cartridge, and US power cable) Spare serial-to-parallel converter cable Black print cartridge Rechargeable battery for deskjet printer Power cable (Europe) for deskjet printer Power cable (Australia) for deskjet printer Power cable (U.K.) for deskjet printer Power cable (So. Africa) for deskjet printer Seiko DPU-414-30BU thermal printer (120 VAC), includes: internal battery, thermal printer paper, serial cable, U.S. power cable
2000-753 2000-661 2000-662 2000-663 2000-664 2000-665 2000-667 2000-754	Seiko DPU-414-30BU thermal printer (220 VAC), includes: internal battery, thermal printer paper, serial cable, Euro. power cable US adapter (for Seiko DPU414-30BU printer) Euro adapter (for Seiko DPU414-30BU printer) Battery pack (cable (for Seiko DPU414-30BU printer) Spare serial –to–parallel cable 9-pin (m) to 9-pin (f) cable (for Seiko DPU414-30BU printer) Five (5) rolls of thermal paper
2000-761	Seiko DPU-414-30BU thermal printer (220 VAC), includes: internal battery, thermal printer paper, serial cable, Euro. power cable
2000-1002 2000-1003 2000-1004 2000-1012	US adapter (for Seiko DPU414-30BU printer) Euro adapter (for Seiko DPU414-30BU printer) Battery pack (cable (for Seiko DPU414-30BU printer) Spare serial –to–parallel cable 9-pin (m) to 9-pin (f) cable (for Seiko DPU414-30BU printer) Five (5) rolls of thermal paper
2000-755	Five (5) rolls of thermal paper
ND44173	Upgrades C751-to-C752 upgrade

HANDHELD SPECTRUM ANALYZER MS2711B 100 kHz to 3.0 GHz

*Fast, Accurate, Repeatable, Portable
Spectrum Analysis* **NEW**



The MS2711B Handheld Spectrum Analyzer provides the “ultimate” in measurement flexibility for field environments and applications requiring mobility. Unlike traditional spectrum analyzers, the MS2711B features a rugged, ultra-lightweight, battery-operated design that enables users to conduct spectrum analysis measurements – anywhere, anytime.

Providing complete freedom from AC/DC power requirements, the MS2711B enables you to locate, identify, record and solve communication systems problems quickly and easily, without sacrificing measurement accuracy.

Whether you are installing, maintaining, or troubleshooting a modern wireless communication system, the MS2711B provides exceptional performance combined with ease-of-use and broad functionality – making it an ideal solution for engineers and technicians who conduct field measurements in the 100 kHz to 3.0 GHz frequency range. In fact, it is ideal for finding the source of interfering signals in modern wireless systems.

Rugged and Reliable

Because the MS2711B was designed specifically for field environments, it can easily withstand the day-to-day punishment of field use. Rugged packaging also keeps the MS2711B performing in harsh environments.

Easy-to-Use

Not only is the MS2711B the lightest fully-functional spectrum analyzer available at 4.5 pounds (base model including battery), operation is straight-forward and driven by firmware that simplifies the process of making measurements and interpreting the results shown on the large, high-resolution LCD display. The menu-driven user interface is easy to use and requires little training.

A full range of marker capabilities such as peak, center and delta functions are also provided, giving users a faster and more comprehensive measurement of displayed signals. Limit lines simplify amplitude measurements, giving users the capability to create quick, simple, pass/fail measurements. Frequency, span and amplitude functions are easily configured for optimum performance. Used together with the Save setup feature, these functions can help to make testing easier and faster for less experienced users.

Powerful Trace Management

Users are able to store ten test setups along with 200 measurement traces internally in the unit's memory. The stored data can be easily downloaded to a personal computer (PC) or a printer via an RS-232 serial cable for further analysis. A notebook computer can be used with the RS-232 interface for automated control and data collection in the field.

A number of options are available that expand the MS2711B's capabilities, including an internal tracking generator (option 20), an internal RF Power monitor (option 5) and a preamplifier (option 8).

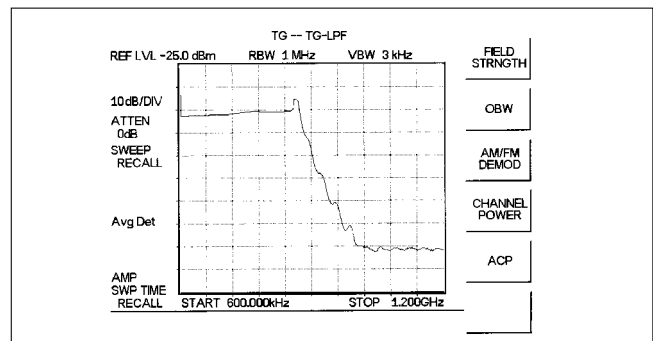
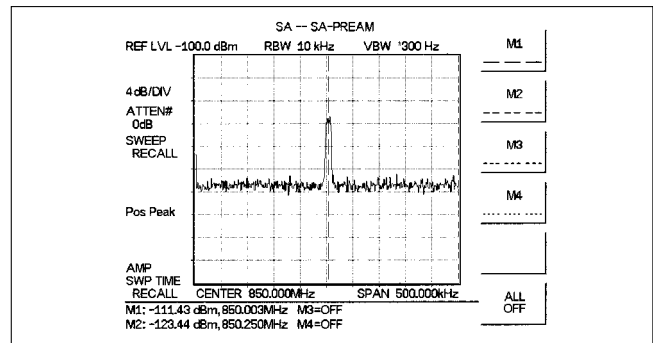

To meet the challenges of today's wireless market, Anritsu Company has developed a new pre-amp option (option 8) for its revolutionary MS2711B hand-held spectrum analyzer which increases the analyzer's sensitivity and dynamic range while improving measurement time. With the pre-amp option, the MS2711B is particularly effective in measuring low-level signals. The handheld spectrum analyzer's sensitivity is improved to -114 dBm (full span). With this option, the MS2711B can identify and make measurements on low-level signals much faster than previously possible.

The improved sensitivity, dynamic range, and measurement speed complement the existing benefits of the MS2711B. Weighing only 4.9 pounds (including a NiMH battery, fully loaded, base model only at 4.5 pounds), the MS2711B is the world's lightest fully functional hand-held spectrum analyzer with the built-in tracking generator option (option 20).

MS2711B has been enhanced so that it can make highly accurate channel power measurements, occupied bandwidth and Adjacent Channel Power Ratio (ACPR) measurements. These are increasingly critical measurements, particularly for power amplifiers used in wireless communication systems. With the enhancements, the MS2711B has dedicated one button channel power, occupied bandwidth, and ACPR measurement capability to significantly reduce test time and expense. The MS2711B also features local language graphical user interface support (in Chinese, Japanese, French, German, and Spanish).

Features

- Lightweight (4.5 lbs - base model, 4.9 lbs with tracking generator - option 20)
- Synthesized-based performance
- Wide dynamic range
- One button, ACP, 0BW, channel power measurement
- Quick zoom-in, zoom-out display
- 5 min warm up
- Manual and automatic attenuator control
- Improved user interface, with local language support in 5 different languages
- Automatic overload and ESD protection
- Built-in AM/FM demodulation
- Built-in field strength measurement
- Ability to store 6 and recall antenna factors
- Full range of marker capabilities including peak, center, and delta functions
- Limit lines for quick, simple pass/fail measurements
- Rugged, reliable packaging
- Battery operated design
 - 2.5 hours of continuous operation
 - Built-in energy conservation that extends battery life beyond an eight-hour workday
 - Operation using a 12.5 Vdc source AC-DC adapter or automotive cigarette lighter adapter, which simultaneously charges the battery
 - Field replaceable battery
- Built in clock and calendar
- Low cost ownership, global warranty

- Data storage and memory
 - Store up to ten test setups and 200 measurement traces in non-volatile memory
 - Stored data is easily and quickly downloaded to a personal computer (PC) or printer
- Powerful trace management
 - Automatically date/time stamped
 - Alphanumeric labeling
- PC reporting software
 - Windows® 95/98/2000/ME, NT Workstation compatible
 - Supports long file names for descriptive labeling
 - Can display an unlimited number of traces for comparison to historical performance
- Monochrome LCD with backlight capability display
- Power monitor option
- Direct printer control via RS232 serial port

Applications

Convenient operating procedures, high sensitivity, and excellent repeatability enable the MS2711B to pinpoint the smallest system performance degradation and allow for easy verification of system compliance. Typical applications include

- Transmitter Spectrum Analysis – occupied bandwidth, power, modulation measurements, location and identification of in-band, out-of-channel spurious and out-of-band spurious signals
- Receive Signal Analysis – measure receiver sensitivity, locate and identify sources of interfering signals
- Modulation identification, modulation depth, deviation, and spectral mask
- Signal Strength Mapping – to determine the most suitable location for antennas, base stations, and repeaters; or pinpoint Electromagnetic (EM) leakage in broadcast systems

Specifications

Except where noted otherwise, specified values are obtained after warming up the Anritsu MS271B Handheld Spectrum Analyzer for 5 minutes at a constant ambient temperature. The typical values are given for reference and are not guaranteed.

Frequency	Frequency range	100 kHz to 3.0 GHz
	Frequency reference	Aging: ± 1 ppm/yr Accuracy: ± 2 ppm
	Frequency span	100 kHz to 3 GHz in 1, 2, 5 step selections in auto mode, plus zero span
	Sweep time	≥ 650 ms full span; 500 ms zero span
	Resolution bandwidth (–3dB width)	10 kHz, 30 kHz, 100 kHz, 1 MHz, $\pm 20\%$
	Video bandwidth (Range –3dB)	100 Hz to 300 kHz in 1-3 sequence
	SSB Phase Noise @30 kHz Offset	≤ -75 dBc/Hz, 30 kHz offset
	Spurious responses	Input related: ≤ -45 dBc
	Spurious residual responses	≤ -95 dBm
Amplitude	Measurement range	-95 dBm to 20 dBm (≥ 300 kHz) -115 dBm to 20 dBm (≥ 300 Hz with Option 8)
	Displayed average noise level	≤ -115 dBm (≥ 300 kHz, typical with Option 8) ≤ -95 dBm (≥ 300 kHz, typical) ≤ -80 dBm (< 299 kHz, typical)
	Dynamic range	> 65 dB, typical
	Total level accuracy	± 2 dB, ≥ 200 kHz, typical; ± 3 dB, < 200 kHz, typical
	Display range	2 to 15 dB/div. In 1 dB steps Ten divisions displayed
	Max input level	+20 dBm, maximum damage -25 dBm with Option 8 +50 Vdc
	Attenuator	Range: 0 to 50 dB, selected manually or automatically coupled to the reference level Resolution: 10 dB steps
	RF input VSWR	2.0:1
General	Internal trace memory	200 maximum
	Setup storage	10 test setups
	RS-232	9 pin D-sub, three wire serial
	Electromagnetic compatibility	Meets European community requirements for CE marking
	Temperature	Operating: 0°C to 50°C, humidity 85% or less Non-operating: -20°C to $+75^\circ\text{C}$
	Power supply	External DC Input: +12.5 to +15 volts dc, 1100 mA max
	Size	25.4 cm (W) 17.8 cm (H) x 6.10 cm (D) 10.0 in (W) x 7.0 in (H) x 2.4 in (D)
Weight	2.04 kg (4.5 lbs.) includes battery, 2.2 kg (4.9 lbs) fully loaded	

MS2711B Preamplifier specifications

Frequency	Frequency range	1.0 MHz to 3.0 GHz
Amplitude	Measurement range	+20 dBm to -115 dBm
	Displayed average noise level	≤-115 dBm (full span typical), ≥300 kHz RBW

MS2711B Tracking generator specifications

Frequency	Frequency range	10.0 MHz to 3.0 GHz
	Frequency resolution	5.0 KHz
	Tracking offset range	±5.0 MHz
Output	Output power level	0 to -60 dBm
	Output power level resolution	0.1 dB
	Absolute level accuracy	±1.5 dB
	Output flatness	≤±1.5 dB (10 MHz – 3 GHz)
	Output tracking VSWR	<1.5:1
	Tracking draft	1 dB
	Dynamic range	>85 dB
	Spurious harmonics	≤-20 dBc

Ordering Information

Please specify model/order number, name, and quantity when ordering.

Model/Order No.	Name	Model/Order No.	Name
MS2711B	HandHeld Spectrum Analyzer: 100 kHz to 3000 MHz	510-97	Adapter 7/16 DIN (f) to 7/16 DIN (f), 3.5 GHz
10580-0070	Standard Accessories	48258	Spare soft carrying case
	User's Guide Soft Carrying Case AC – DC Adapter Automotive Cigarette Lighter/12 Volt DC Adapter One Year Warranty CD ROM containing Software Management Tools Serial Interface Cable Rechargeable battery, NiMH	40-115	Spare AC/DC adapter
Option 5	Optional Accessories	806-62	Spare automotive cigarette lighter/12 Volt DC adapter
Option 8	RF Watt Meter Power Monitor (RF Detector not included)	800-441	Spare serial interface cable
Option 20	Pre-amplifier (built-in)	760-215A	Transit case for Anritsu HandHeld Spectrum Analyzer
5400-71N50	Tracking generator (built-in)	2300-347	Anritsu HandHeld Spectrum Analyzer Software Tools
42N50A-30	RF Detector, N(m), 50 Ohm, 1 to 3000 MHz 30 dB, 50 Watt, Bi-directional, DC to 18 GHz, N(m) to N(f) Attenuator	10580-00074	Anritsu HHSA User's Guide, Model MS2711B (spare)
1091-26	Adapter, DC to 18 GHz, 50 Ohm, N(m) to SMA(m)	10580-00071	Anritsu HHSA Programming Manual, Model MS2711B
1091-27	Adapter, DC to 18 GHz, 50 Ohm, N(m) to SMA(f)	10580-00072	Anritsu HHSA Maintenance Manual, Model MS2711B
1091-172	Adapter, DC to 1.3 GHz, 50 Ohm, N(m) to BNC(f)	633-27	Rechargeable battery, NiMH
34NN50A	Precision Adapter, DC to 18 GHz, 50 Ohm, N(m) to N(m)	2000-1029	Battery charger, NiMH with universal power supply
34NFF50A	Precision Adapter, DC to 18 GHz, 50 Ohm, N(f) to N(f)	2000-1030	Portable antenna, 50 Ohm, SMA (m) 1.71-1.88 GHz
15NN50-1.5C	Test port cable armored, 1.5 meter, N(m) to N(m), 3.5 GHz	2000-1031	Portable antenna, 50 Ohm, SMA (m) 1.85-1.99 GHz
15NN50-3.0C	Test port cable armored, 3.0 meter, N(m) to N(m), 3.5 GHz	2000-1032	Portable antenna, 50 Ohm, SMA (m) 12.4-2.5 GHz
15NN50-5.0C	Test port cable armored, 5.0 meter, N(m) to N(m), 3.5 GHz	2000-1034	Portable antenna, 50 Ohm, SMA (f) 806-869 MHz
15NNF50-1.5C	Test port cable armored, 1.5 meter, N(m) to N(f), 3.5 GHz	2000-1035	Portabel antenna, 50 Ohm, SMA (m) 902-960 MHz
15NNF50-3.0C	Test port cable armored, 3.0 meter, N(m) to N(f), 3.5 GHz		
15NNF50-5.0C	Test port cable armored, 5.0 meter, N(m) to N(f), 3.5 GHz		
15ND50-1.5C	Test port cable armored, 1.5 meter, N(m) to 7/16 DIN(m), 3.5 GHz		
15NDF50-1.5C	Test port cable armored, 1.5 meter, N(m) to 7/16 DIN(f), 3.5 GHz	2000-766	Printers HP DeskJet printer Includes: interface cable, black print cartridge, and US power cable
510-90	Adapter 7/16 (f) to N(m), 3.5 GHz	2000-753	Spare serial-to-parallel converter cable
510-91	Adapter, DC to 3.5 GHz, 50 Ohm, 7/16 (f)-N(f)	2000-661	Black print cartridge
510-92	Adapter, DC to 3.5 GHz	2000-663	Power cable (Europe) for DeskJet printer
510-96	Adapter 7/16 DIN (m) to 7/16 DIN (m), 3.5 GHz	2000-664	Power cable (Australia) for DeskJet printer
		2000-665	Power cable (UK) for DeskJet printer
		2000-667	Power cable (So. Africa) for DeskJet printer
		2000-755	Five (5) rolls of thermal paper
		2000-1002	U.S. adapter (for Seiko DPU-414-30B)
		2000-1003	Euro. adapter (for Seiko DPU-414-30B)
		2000-1194	Japan adapter (for Seiko DPU-414-30B)
		2000-1004	Battery Pack (for Seiko DPU-414-30B)
		2000-1008	Seiko DPU-414-30B thermal printer (120 VAC) Includes: internal battery, thermal printer paper, serial cable, US power cable
		2000-1012	Serial 9-pin (m) to 9-pin (f) cable
		2000-1046	Serial-to Parallel Converter Cable

SITE MASTER S100C/S200C/S300C/S800A Series

2 MHz to 20 GHz

For Analyzing Cable and Antenna Problems

NEW



CE GPIB

5

Site Master is the instrument of choice for transmission line/antenna installation and maintenance. It is the best way to reduce maintenance expenses and improve quality. It replaces stacks of heavy, expensive, and complex test equipment. Site Master's frequency domain reflectometry technique allows it to locate faults before they become catastrophic faults, thereby creating huge cost savings.

The Site Master is a precision, hand-held return loss/SWR and fault location measurement instrument. The Site Master series offers wide frequency coverage, from 2 MHz to 20 GHz. Built-in fault location, RF power monitor, bias tee, and spectrum analysis capabilities are available. Light weight, rugged design, and wide temperature range make them ideal for field applications. Site Master's proprietary design provides superior immunity to on-channel RF interference, which is important for live site testing. Site Master Software Tools is a Windows® compatible software program provided with every Site Master unit. This software program provides many useful features, including a database for Site Master measurements, Smith Chart display of S11, zoom capability, a "drag-n-drop" overlay for measurement comparison, the capability to download data to a PC, the capability to upload data such as custom cable list or traces to selected Site Master model, and distance-to-fault calculation from return loss or SWR plots. Advanced printing capabilities are provided by Site Master Software Tools including user definable plot scaling and a multiple plots per page option. Site Master is the first test tool to provide the required accuracy, interference immunity, and repeatability for transmission line/antenna commissioning, and maintenance of today's wireless systems infrastructures.

Features

- Accurate return loss/SWR and fault location measurements
- Accurately tests RF transmission lines and antennas
- Superior immunity to on-channel interference for testing at co-located antenna sites
- Multilingual user interface: German, Spanish, French, Chinese, Japanese
- Insertion Loss/Gain (S251C only)
- Spectrum analysis (S114C and S332C only)
- Optional RF power monitor
- Optional built-in bias tee (S251C only)
- Synthesizer accurate to 75 ppm
- Internal memory saves up to 200 traces
- Instrument configuration up to 10 configurations
- Alphanumeric trace naming ("C" version only)
- Time, Date stamp ("C" version only)
- Field replaceable battery ("C" version only)
- Segmented limit lines

- Six markers
- Graticule lines
- Test Port Detector (S113C, S114C only)
- Trace overlay
- Direct printing via RS-232 serial port
- Remote operation via RS-232 serial port

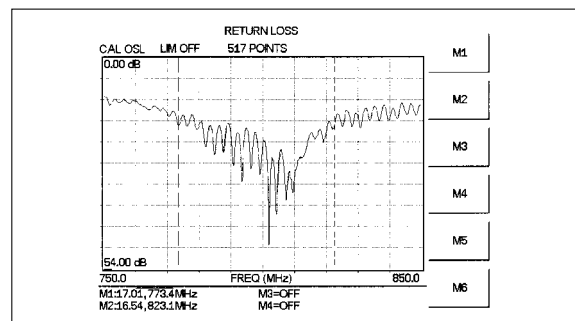

Return loss

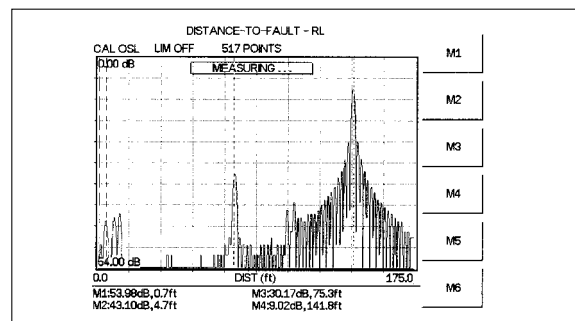

Distance-to-fault

Applications

Cellular, ISM, PCS/PCN, paging service, safety service, avionics, two-way radio, military, and microwave point-to-point radio. Site Master allows implementation of preventative maintenance procedures. Unlike TDRs and spectrum analyzers/tracking generators, Site Master can spot RF degradation before failures occur. Problems can be fixed before expensive cables or waveguides are ruined.

Site Master is designed for field requirements. Its rugged construction survives rough field treatment. Battery power, light weight, small size, wide temperature range, and simple user interface are exactly what field technicians want today. Technicians can test antennas from ground level because Site Master's distance-to-fault measurement compensates for cable

insertion loss. Furthermore, spectrum analysis, available in certain Site Master models, allows technicians and field engineers to quickly identify and solve common RF system problems, such as coverage, interference, and other path related signal problems. Site Master offers a new and better method to install and maintain transmission lines and antennas.

Specifications*1

Model	S251C	S113C/S331C		S114C/S332C	
Frequency range	625 to 2500 MHz	2 to 1600 MHz (S113C) 25 to 4000 MHz (S331C)		2 to 1600 MHz (S114C) 25 to 4000 MHz (S332C)	
Frequency resolution	10 kHz	100 kHz		100 kHz	
Frequency accuracy (CW mode)	75 ppm				
Display data points	Selectable: 130, 259, 517				
Immunity to interfering RF signals	S251C	S113C	S331C	S114C	S332C
On-frequency*3	+10 dBm (RF out), +30 dBc transmission	+10 dBm	-5 dBm	+10 dBm	-5 dBm
On-channel*4	+17 dBm	+17 dBm	+17 dBm	+17 dBm	+17 dBm
Return loss	Range: 0 to 54 dB; Resolution: 0.01 dB				
SWR	Range: 1 to 65; Resolution: 0.01				
Cable loss	Range: 0 to 20 dB; Resolution: 0.01 dB				
Insertion Loss/Gain S251C only	Display range: -120 to +100 dB Resolution: 0.1 dB	N/A		N/A	
Distance-to-fault	Vertical range Return loss: 0 to 54 dB SWR: 1 to 65 Horizontal range (meter): 0 to (dp x resolution), where dp = 128, 256 or 512 Horizontal resolution, rectangular windowing resolution (meter): (1.5×10^8) (Up)/ Δ frequency*5				
RF power monitor (Option 5)	Display range: -80 to +80 dBm, 10 pW to 100 kW Detector range: -50 to +20 dBm, 10 nW to 100 mW Offset range: 0 to +60 dB Resolution: 0.1 dB				
Bias Tee (Option 10A) S251C only	+15 VDC, Surge: 275 mA maximum, 25 ms; Steady State: 240 mA maximum	N/A		N/A	
Spectrum analysis					
Frequency range	N/A	N/A		100 kHz to 1600 MHz (S114C) 100 kHz to 3000 MHz (S332C)	
Accuracy	N/A	N/A		± 2 ppm	
Aging	N/A	N/A		± 1 ppm/yr	
Frequency span	N/A	N/A		0 Hz (zero span), 100 kHz to full span	
Resolution bandwidth	N/A	N/A		10 kHz, 30 kHz, 100 kHz, 1 MHz	
Video Bandwidth	N/A	N/A		100 Hz to 300 kHz in 1-3 sequence	
Display datapoint	N/A	N/A		400	
SSB Phase Noise @ (1 GHz) 30 kHz offset	N/A	N/A		≤ -75 dBc/Hz	
Spurious responses (Input related)	N/A	N/A		< -95 dBm	
Spurious responses (residual)	N/A	N/A		≤ -45 dBc	
Dynamic range	N/A	N/A		≥ 65 dB	
Average noise level	N/A	N/A		≤ -97 dBm (full span)	
Measurement range	N/A	N/A		+20 dBm to -97 dBm	
Display range	N/A	N/A		2 to 15 dB/div in 1 dB steps, 10 divisions display	
Total level accuracy	N/A	N/A		± 2 dB >300 kHz, typical ± 3 dB <300 kHz, typical	
RF input VSWR	N/A	N/A		2.0:1	
Trace memory	Up to 200				
Instrument configuration*6	10				
Test port connector	Precision N female				
Maximum input	RF OUT test port: +22 dBm, 50 Ω , +50 Vdc RF IN test port: +10 dBm, 50 Ω , +50 Vdc RF power detector: +20 dBm, 50 Ω , +50 Vdc	RF power detector: +20 dBm, 50 Ω , +50 Vdc		RF IN Spectrum Analyzer port: +20 dBm safe input, +27 dBm damage level, Peak Pulse Power +50 Vdc RF power detector: +20 dBm, 50 Ω , +50 Vdc	
Temperature	Operating: 0°C to +50°C Storage: -20°C to +75°C				
Weight	2.18 kg (4.78 lbs.) nominal				
Size	25.4 cm x 17.8 cm x 6.1 cm (10 in x 7 in x 2.4 in)				
General	Electromagnetic compatibility: Meets European community requirements for CE marking. RS232: 9 pin D-sub, three wire serial				

Continued on next page

- *1: All specifications apply when calibrated at ambient temperature after a five minutes warm up.
- *2: In most applications, immunity is typically better because interfering signals are modulated and varying in frequency rather than being CW. Measurements were made in CW mode by injecting a signal into the Site Master through a coupler.
- *3: On-Frequency interference immunity is specified to within +10 kHz of the carrier frequency.
- *4: On-Channel interference immunity is specified to within 1 MHz of the carrier frequency.
- *5: Where v_p is the cable's relative propagation velocity. Δ frequency is the stop frequency minus the start frequency (in Hz). Wide frequency sweeps improve resolution but reduce maximum display range.
- *6: Calibration stored with instrument configuration.

InstaCal® Calibration Module*

The InstaCal calibration module is available for all one-port Site Master models (S113C, S114C, S331C and S332C). With InstaCal, users can cut the time required to calibrate the Site Master by as much as 50%. Moreover, InstaCal reduces the potential for calibration error. With discrete calibration components users are required to connect, disconnect, and reconnect the various calibration components during the calibration process, which greatly increases the potential for calibration/measurement error. With InstaCal, users are only required to connect the InstaCal calibration module once – the calibration process sequences automatically, ensuring an accurate calibration of the Site Master. The benefit is calibrated measurements in much less time.



*The InstaCal® Calibration Module exhibits slightly degraded directivity performance compared to precision loads. Users having applications that require DTF-RL measurements > |38 dB| may want to consider using precision load calibration components in place of the InstaCal calibration module for greater measurement accuracy.



Specifications*1

Model	S810A/S818A/S820A
Frequency range	3.3 to 10.5 GHz (S810A) 3.3 to 18.0 GHz (S818A) 3.3 to 20.0 GHz (S820A)
Frequency accuracy (CW mode)	75 ppm
Frequency resolution	1 MHz
Immunity to interfering RF signals up to*2	-10 dBm
Return loss	Range: 0 to 54 dB, Resolution: 0.01 dB
SWR	Range: 1 to 65, Resolution: 0.01
Cable/Waveguide Loss	Range: 0 to 20 dB, Resolution: 0.01 dB
Distance-to-fault (S810A, S818A, S820A)	Vertical range Return loss: 0 to 54 dB SWR: 1 to 65 Horizontal range: 0 to 128 x (resolution) Horizontal resolution, rectangular windowing resolution (meter): Coax: $(1.5 \times 10^9)(v_p)/\Delta$ frequency*3 Waveguide: $(1.5 \times 10^9)(\sqrt{1-(F_c/F_1)^2})/\Delta$ frequency*4
Wattmeter (RF power monitor, Option 5)	Display range: -80 to +80 dBm, 10 pW to 100 kW Detector range: -50 to +20 dBm, 10 nW to 100 mW Offset range: 0 to +60 dB Resolution: 0.1 dB, 0.1 x W
Trace memory	70
Instrument configuration with calibration	6
Test port connector	Precision N female
Maximum input without damage	N(f) test port: +22 dBm RF power detector: +20 dBm, 50 Ω
Temperature	Operating: 0°C to 50°C Storage: -20°C to 75°C
Weight	1.36 kg (3.0 lbs.) nom (S800A series)
Size	203.2 mm x 177.8 mm x 57.2 mm (8 in x 7 in x 2.25 in)
General	Electromagnetic compatibility: Meets European community requirements for CE marking. RS232: 9-pin D-sub, three wire serial

- *1: All specifications apply when calibrated at ambient temperature after a five minute warm up.
- *2: In most applications, immunity is typically better because interfering signals are modulated and varying in frequency rather than being CW. Measurements were made in CW mode by injecting a signal into the Site Master through a coupler.
- *3: Where v_p is the cable's relative propagation velocity. Δ frequency is the stop frequency minus the start frequency (in Hz). Wide frequency sweeps improve resolution but reduce maximum display range.
- *4: Where F_c is the waveguide's cutoff frequency (in Hz) and F_1 is the start frequency (in Hz). Δ frequency is the stop frequency minus the start frequency (in Hz). Wide frequency sweeps improve resolution but reduce maximum display range.

Ordering Information

Please specify model/order number, name, and quantity when ordering.

Model/Order No.	Name
Model S113C Model S114C	Main frame Site Master (2 to 1600 MHz), Built in DTF Site Master (2 to 1600 MHz), Built in DTF, Spectrum Analysis (100 kHz to 1.6 GHz)
Model S251C Model S331C Model S332C	Site Master (625 to 2500 MHz), Built in DTF, 2-port Site Master (25 to 4000 MHz), Built in DTF Site Master (25 to 4000 MHz), Built in DTF, Spectrum Analysis (100 kHz to 3.0 GHz)
Model S810A Model S818A Model S820A	Site Master (3.3 to 10.5 GHz), Built in DTF Site Master (3.3 to 18.0 GHz), Built in DTF Site Master (3.3 to 20.0 GHz), Built in DTF
	Standard accessories InstaCAL (standard on S113C, S114C, S331C, S332C) User's Guide Soft Carrying Case AC-DC Adapter Automotive Cigarette Lighter/12 Volt DC Adapter One Year Warranty CD ROM containing Fault Location (DTF), Smith Chart, and Software Management Tools Serial Interface Cable Rechargeable battery, NiMH ("C" version only) Precision ruggedized K(m) to N(f) adapter (S820A only)
Option 5 Option 10A	Option RF Watt Meter Power Monitor (RF detector not included) Built-in Bias Tee (240 mA) - S251C only
42N50A-30 42N50-20 ICN50 5400-71N50 560-7N50B 560-7K50 560-7VA50 IN50C 22K50 22KF50 22N50 22NF50 SM/STS SM/STSNF SM/PL SM/PLNF SM/STL OSLN50LF OSLNF50LF 28K50 28KF50 28N50-2 28NF50-2 2000-767 2000-768 15ND50-1.5C 15NN50-1.5C 15NN50-3.0C 15NN50-5.0C 15NNF50-1.5B 15NNF50-1.5C 15NNF50-3.0C 15NNF50-5.0C 15KKF50-1.5A 15NDF50-1.5C 15RKKF50-1.5A 800-109 800-110 800-111 800-112 34NN50A 34NPNF50 34RKNF50 34RSN50	Optional accessories Attenuator, 30 dB, DC to 18 GHz, 50 W Attenuator, 20 dB, DC to 18 GHz, 5 W InstaCAL (standard on S113C, S114C, S331C, S332C) RF Detector, N(m), 50 Ohm, 1 to 3000 MHz RF Detector, N(m), 50 Ohm, 10 MHz to 20 GHz RF Detector, K(m), 50 Ohm, 10 MHz to 40 GHz RF Detector, V(m), 50 Ohm, 10 MHz to 50 GHz 5W Limiter, N(m)-N(f), 18 GHz Precision K(m) Short/Open, 40 GHz Precision K(f) Short/Open, 40 GHz Precision N(m) Short/Open, 18 GHz Precision N(f) Short/Open, 18 GHz Standard N(m) Short, 3.5 GHz Standard N(f) Short, 3.5 GHz Precision N(m) Load, 42 dB, 4.0 GHz Precision N(f) Load, 42 dB, 4.0 GHz Standard N(m) Load, 35 dB, 3.5 GHz Precision N(m) Open/short/Load, 42 dB, 4.0 GHz Precision N(f) Open/short/Load, 42 dB, 4.0 GHz Precision N(m) Load, 40 GHz Precision N(f) Load, 40 GHz Precision N(m) Load, 40 dB, 18 GHz Precision N(f) Load, 40 dB, 18 GHz Precision Open/Short/Load, 7-16 (m), 3.5 GHz Precision Open/Short/Load, 7-16 (f), 3.5 GHz Test Port Ext. Cable, 3.5 GHz, 1.5 meters Test Port Ext. Cable, 6 GHz, 1.5 meters Test Port Ext. Cable, 6 GHz, 3.0 meters Test Port Ext. Cable, 6 GHz, 5.0 meters Test port cable armored, 1.5 meter, N(m) to N(f), 18 GHz Test port cable armored, 1.5 meter, N(m) to N(f), 6.0 GHz Test port cable armored, 3.0 meter, N(m) to N(f), 6.0 GHz Test port cable armored, 5.0 meter, N(m) to N(f), 6.0 GHz Test port cable armored, 1.5 meter, K(m) to K(f), 26.5 GHz Test port cable armored, 1.5 meter, N(m) to 7/16 DIN(f), 3.5 GHz Test port cable armored, 1.5 meter, K(m) to K(f), 26.5 GHz Detector extender cable, 7.6 m (25 ft.) Detector extender cable, 15.2 m (50 ft.) Detector extender cable, 30.5 m (100 ft.) Detector extender cable, 61 m (200 ft.) Precision N(m) to N(m) Adapter, 18 GHz Precision N(f) to N(f) Adapter, 18 GHz Precision Ruggedized K(m) to N(f) Adapter, 20 GHz Precision Ruggedized W SMA(m) to N(m) Adapter, 20 GHz

Model/Order No.	Name
K220B K222B 1091-26 1091-27 1091-80 1091-81 1091-172 510-90 510-91 510-92 510-93 510-96 510-97 D41955 48258 40-115 806-62 800-441 760-213 760-215A 633-27 2300-347 10580-00014 10580-00060	Precision K(m)-K(m) Adapter, 40 GHz Precision K(f)-K(f) Adapter, 40 GHz Adapter N(m) to SMA(m), 18 GHz Adapter N(m) to SMA(f), 18 GHz Adapter, N(f) to SMA(n), 18 GHz Adapter, N(f) to SMA(f), 18 GHz Adapter, DC to 1.3 GHz, 50 Ohm, N(m) to BNC(f) Adapter 7-16(f) to N(m), 3.5 GHz Adapter 7-16(f) to N(f), 3.5 GHz Adapter 7-16(m) to N(m), 3.5 GHz Adapter 7-16(m) to N(f), 3.5 GHz Adapter 7/16 (m) to 7/16 (m), 3.5 GHz Adapter 7/16 (f) to 7/16 (f), 3.5 GHz Spare Soft Carrying Case Spare Soft Carrying Case for "C" version Site Master Spare AC/DC Adapter Spare Automotive Cigarette Lighter/12 Volts DC adapter Spare Serial Interface Cable Transit Case for S800 Series Site Master Transit Case for Site Master Rechargeable battery, NiMH for "C" version Site Master Spare Site Master Software Tools Spare Site Master S810A, S818A User's Guide Spare Site Master User's Guide (S113C, S114C, S331C & S332C)
10580-00030 10580-00065 10580-00015 10580-00061	Spare Site Master S820A User's Guide Spare Site Master User's Guide (S251C) Site Master Programming Manual (for S810A, S818A, S820A) Site Master Programming Manual (for S113C, S114C, S331C, S332C)
10580-00066 10580-00022 10580-00062	Site Master Programming Manual (for S251C) Site Master Maintenance Manual (for S810A & S818A) Site Master Maintenance Manual (for S113C, S114C, S331C & S332C)
10580-00031 10580-00067 2000-766	Site Master Maintenance Manual (for S820A) Site Master Maintenance Manual (for S251C) HP DeskJet printer includes: serial-to-parallel interface cable, black print cartridge, and US power cable
2000-753 2000-661 2000-662 2000-663 2000-664 2000-665 2000-667 2000-1008	Spare serial-to-parallel converter cable Black print cartridge Rechargeable battery for DeskJet printer Power cable (Europe) for DeskJet printer Power cable (Australia) for DeskJet printer Power cable (UK) for DeskJet printer Power cable (So. Africa) for DeskJet printer Seiko DPU-441-30BU thermal printer (120VAC) Includes: internal battery, thermal printer paper, serial cable, US power cable
2000-761	Seiko DPU-441-30BU thermal printer (220VAC) Includes: internal battery, thermal printer paper, serial cable, Euro power cable
2000-755 2000-756	Five (5) rolls of thermal paper Spare serial 9-pin to 25-pin D-sub converter cable (Seiko DPU-411)
2000-1002 2000-1003 2000-1194 2000-1004 2000-1012	US Adapter (for Seiko DPU-41-30BU printer) Europe Adapter (for Seiko DPU-41-30BU printer) Japan adapter (for Seiko DPU-41-30BU) Battery pack (for Seiko DPU-41-30BU printer) Spare serial 9-pin(m) to 9-pin (f) cable (for Seiko DPU-41-30BU printer)
2000-1029 2000-1030 2000-1031 2000-1032 2000-1034 2000-1035	Battery charger, NiMH for "B" version Site Master Portable antenna, SMA (m) 1.71 to 1.88 GHz Portable antenna, SMA (m) 1.85 to 1.99 GHz Portable antenna, SMA (m) 2.4 to 2.5 GHz Portable antenna, SMA (f) 806 to 869 MHz Portable antenna, SMA (m) 902 to 960 MHz

Universal Waveguide Component Accessories

Part number	Description	Freq. range	Waveguide type	Compatible flanges
XXUM40	1/8, 3/8 λ Offset Short and Load, Metric	3.30 to 4.90 GHz	WR229, WG11A	PDR40
XXUM48	1/8, 3/8 λ Offset Short and Load, Metric	3.95 to 5.85 GHz	WR187, WG12	CAR48, PAR48, UAR48, PDR48
XXUM58	1/8, 3/8 λ Offset Short and Load, Metric	4.90 to 7.05 GHz	WR159, WG13	CAR58, PAR58, UAR58, PDR58
XXUM70	1/8, 3/8 λ Offset Short and Load, Metric	5.85 to 8.20 GHz	WR137, WG14	CAR70, PAR70, UAR 70, PDR70
XXUM84	1/8, 3/8 λ Offset Short and Load, Metric	7.05 to 10.00 GHz	WR112, WG15	CBR84, UBR84, PBR84, PDR84
XXUM100	1/8, 3/8 λ Offset Short and Load, Metric	8.20 to 12.40 GHz	WR90, WG16	CBR100, UBR100, PBR100, PDR100
XXUM120	1/8, 3/8 λ Offset Short and Load, Metric	10.00 to 15.00 GHz	WR75, WG17	CBR120, UBR120, PBR120, PDR120
XXUM140	1/8, 3/8 λ Offset Short and Load, Metric	12.40 to 18.00 GHz	WR62, WG18	CBR140, UBR140, PBR140, PDR140
XXUM220	1/8, 3/8 λ Offset Short and Load, Metric	17.00 to 26.50 GHz	WR42, WG20	CBR220, UBR220, PBR220, PDR220
XXUA229	1/8, 3/8 λ Offset Short and Load, US	3.30 to 4.90 GHz	WR229, WG11A	CPR229F, CPR229G, UG-1350/U, UG-1351/U, UG-1726/U, UG-1727/U
XXUA187	1/8, 3/8 λ Offset Short and Load, US	3.95 to 5.85 GHz	WR187, WG12	CPR187F, CPR187G, UG-1352/U, UG-1353/U, UG-1728/U, UG-1729/U, UG-148/U, UG-149A/U
XXUA159	1/8, 3/8 λ Offset Short and Load, US	4.90 to 7.05 GHz	WR159, WG13	CPR159F, CPR159G, UG-1354/U, UG-1355/U, UG-1730/U, UG-1731/U
XXUA137	1/8, 3/8 λ Offset Short and Load, US	5.85 to 8.20 GHz	WR137, WG14	CPR137F, CPR137G, UG-1356/U, UG-1357/U, UG-1732/U, UG-1733/U, UG-343B/U, UG-344/U, UG-440B/U, UG-441/U
XXUA112	1/8, 3/8 λ Offset Short and Load, US	7.05 to 10.00 GHz	WR112, WG15	CPR112F, CPR112G, UG-1358/U, UG-1359/U, UG-1734/U, UG-1735/U, UG-52B/U, UG-51/U, UG-137B/U, UG-138/U
XXUA90	1/8, 3/8 λ Offset Short and Load, US	8.20 to 12.40 GHz	WR90, WG16	CPR90F, CPR90G, UG-1360/U, UG-1361/U, UG-1736/U, UG-1737/U, UG-40B/U, UG-39/U, UG-135/U, UG-136B/U
XXUA75	1/8, 3/8 λ Offset Short and Load, US	10.00 to 15.00 GHz	WR75, WG17	WR75
XXUA62	1/8, 3/8 λ Offset Short and Load, US	12.40 to 18.00 GHz	WR62, WG18	UG-541A/U, UG-419/U, UG-1665/U, UG1666/U
XXUA42	1/8, 3/8 λ Offset Short and Load, US	17.00 to 26.50 GHz	WR42, WG20	UG-596A/U, UG-595/U, UG-597/U, UG-598A/U
XXCMR229	1/8, 3/8 λ Offset Short and Load, CMR	3.30 to 4.90 GHz	WR229, WG11A	CMR229
XXCMR187	1/8, 3/8 λ Offset Short and Load, CMR	3.95 to 5.85 GHz	WR187, WG12	CMR187, UG1475/U, UG1480/U
XXCMR159	1/8, 3/8 λ Offset Short and Load, CMR	4.90 to 7.05 GHz	WR159, WG13	CMR159
XXCMR137	1/8, 3/8 λ Offset Short and Load, CMR	5.85 to 8.20 GHz	WR137, WG14	CMR137, UG1476/U, UG1481/U
XXCMR112	1/8, 3/8 λ Offset Short and Load, CMR	7.05 to 10.00 GHz	WR112, WG15	CMR112, UG1477/U, UG1482/U
XXCMR90	1/8, 3/8 λ Offset Short and Load, CMR	8.20 to 12.40 GHz	WR90, WG16	CMR90, UG1478/U, UG1483/U
XXUER40	1/8, 3/8 λ Offset Short and Load, UER	3.30 to 4.90 GHz	WR229, WG11A	UER40
XXUER48	1/8, 3/8 λ Offset Short and Load, UER	3.95 to 5.85 GHz	WR187, WG12	UER48
XXUER58	1/8, 3/8 λ Offset Short and Load, UER	4.90 to 7.05 GHz	WR159, WG13	UER58
XXUER70	1/8, 3/8 λ Offset Short and Load, UER	5.85 to 8.20 GHz	WR137, WG14	UER70
XXUER84	1/8, 3/8 λ Offset Short and Load, UER	7.05 to 10.00 GHz	WR112, WG15	UER84
XXUER100	1/8, 3/8 λ Offset Short and Load, UER	8.20 to 12.40 GHz	WR90, WG16	UER100

Precision waveguide calibration components

Note: Part number Ordering information
 Prefix (XX) - 23 for 1/8 λ offset short
 - 24 for 3/8 λ offset short
 - 26 for Precision waveguide load

Part number	Description	Freq range	Waveguide type	Compatible flanges
35UM40N	Coaxial Adapter, N(m), Metric	3.30 to 4.90 GHz	WR229, WG11A	PDR40
35UM48N	Coaxial Adapter, N(m), Metric	3.95 to 5.85 GHz	WR187, WG12	CAR48, PAR48, UAR48, PDR48
35UM58N	Coaxial Adapter, N(m), Metric	4.90 to 7.05 GHz	WR159, WG13	CAR58, PAR58, UAR58, PDR58
35UM70N	Coaxial Adapter, N(m), Metric	5.85 to 8.20 GHz	WR137, WG14	CAR70, PAR70, UAR 70, PDR70
35UM84N	Coaxial Adapter, N(m), Metric	7.05 to 10.00 GHz	WR112, WG15	CBR84, UBR84, PBR84, PDR84
35UM100N	Coaxial Adapter, N(m), Metric	8.20 to 12.40 GHz	WR90, WG16	CBR100, UBR100, PBR100, PDR100
35UM120N	Coaxial Adapter, N(m), Metric	10.00 to 15.00 GHz	WR75, WG17	CBR120, UBR120, PBR120, PDR120
35UM140N	Coaxial Adapter, N(m), Metric	12.40 to 18.00 GHz	WR62, WG18	CBR140, UBR140, PBR140, PDR140
35UM220K	Coaxial Adapter, K(m), Metric	17.00 to 26.50 GHz	WR42, WG20	CBR220, UBR220, PBR220, PDR220
35UA229N	Coaxial Adapter, N(m), US	3.30 to 4.90 GHz	WR229, WG11A	CPR229F, CPR229G, UG-1350/U, UG-1351/U, UG-1726/U, UG-1727/U
35UA187N	Coaxial Adapter, N(m),US	3.95 to 5.85 GHz	WR187, WG12	CPR187F, CPR187G, UG-1352/U, UG-1353/U, UG-1728/U, UG-1729/U, UG-148/U, UG-149A/U
35UA159N	Coaxial Adapter, N(m), US	4.90 to 7.05 GHz	WR159, WG13	CPR159F, CPR159G, UG-1354/U, UG-1355/U, UG-1730/U, UG-1731/U
35UA137N	Coaxial Adapter, N(m), US	5.85 to 8.20 GHz	WR137, WG14	CPR137F, CPR137G, UG-1356/U, UG-1357/U, UG-1732/U, UG-1733/U, UG-343B/U, UG-344/U, UG-440B/U, UG-441/U
35UA112N	Coaxial Adapter, N(m),US	7.05 to 10.00 GHz	WR112, WG15	CPR112F, CPR112G, UG-1358/U, UG-1359/U, UG-1734/U, UG-1735/U, UG-52B/U, UG-51/U, UG-137B/U, UG-138/U
35UA90N	Coaxial Adapter, N(m),US	8.20 to 12.40 GHz	WR90, WG16	CPR90F, CPR90G, UG-1360/U, UG-1361/U, UG-1736/U, UG-1737/U, UG-40B/U, UG-39/U, UG-135/U, UG-136B/U
35UA75N	Coaxial Adapter, N(m), US	10.00 to 15.00 GHz	WR75, WG17	WR75
35UA62N	Coaxial Adapter, N(m), US	12.40 to 18.00 GHz	WR62, WG18	UG-541A/U, UG-419/U, UG-1665/U, UG1666/U
35UA42K	Coaxial Adapter, K(m), US	17.00 to 26.50 GHz	WR42, WG20	UG-596A/U, UG-595/U, UG-597/U, UG-598A/U
35CMR229N	Coaxial Adapter, N(m), CMR	3.30 to 4.90 GHz	WR229, WG11A	CMR229
35CMR187N	Coaxial Adapter, N(m), CMR	3.95 to 5.85 GHz	WR187, WG12	CMR187, UG1475/U, UG1480/U
35CMR159N	Coaxial Adapter, N(m), CMR	4.90 to 7.05 GHz	WR159, WG13	CMR159
35CMR137N	Coaxial Adapter, N(m), CMR	5.85 to 8.20 GHz	WR137, WG14	CMR137, UG1476/U, UG1481/U
35CMR112N	Coaxial Adapter, N(m), CMR	7.05 to 10.00 GHz	WR112, WG15	CMR112, UG1477/U, UG1482/U
35CMR90N	Coaxial Adapter, N(m), CMR	8.2 to 12.4 GHz	WR90, WG16	CMR90, UG1478/U, UG1483/U
35UER40N	Coaxial Adapter, N(m), UER	3.30 to 4.90 GHz	WR229, WG11A	UER40
35UER48N	Coaxial Adapter, N(m), UER	3.95 to 5.85 GHz	WR187, WG12	UER48
35UER58N	Coaxial Adapter, N(m), UER	4.90 to 7.05 GHz	WR159, WG13	UER58
35UER70N	Coaxial Adapter, N(m), UER	5.85 to 8.20 GHz	WR137, WG14	UER70
35UER84N	Coaxial Adapter, N(m), UER	7.05 to 10.00 GHz	WR112, WG15	UER84
35UER100N	Coaxial Adapter, N(m) UER	8.2 to 12.4 GHz	WR90, WG16	UER100

Precision waveguide-to-coaxial adapters

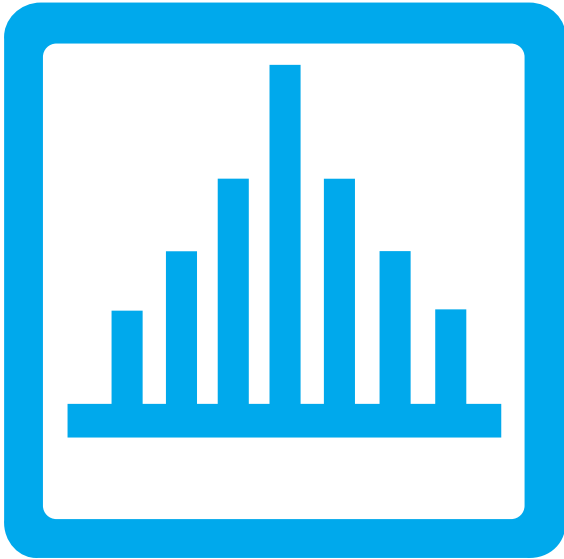

SPECTRUM ANALYZERS

Selection Guide	304
Spectrum Analyzers	305, 310, 315, 321, 326, 332, 339
Pre-Amplifier	347

Spectrum analyzer selection guide

Model	Measurement frequency range	Measurement level range (dBm)	Resolution bandwidth	High-level accuracy	C/N (dBc/Hz) ^{*1}	RF-band harmonic distortion (dBc) ^{*2}	Third order intermodulation distortion (dBc) ^{*2}	Counter	Measure	Zone marker	AM/FM demodulation mode	QP detection	High-speed time domain	Gate	Tracking generator	GPIB	PTA	Features
MS2651B	9 kHz to 3 GHz	-110 to +30	1 kHz to 5 MHz	√	-90	-60	-70	√	√	√	√	Opt.	Opt.	Opt.	Opt.	√	√	Portable
MS2661B	9 kHz to 3 GHz	-115 to +30, -130 to +30 (with Opt.)	1 kHz to 5 MHz, 30 Hz to 5 MHz (with Opt.)	√	-100	-75	-80	√	√	√	Opt.	Opt.	Opt.	Opt.	Opt.	√	√	
MS2661C	9 kHz to 3 GHz	-115 to +30, -130 to +30 (with Opt.)	1 kHz to 3 MHz, 30 Hz to 3 MHz (with Opt.)	√	-100	-75	-80	√	√	√	Opt.	Opt.	Opt.	Opt.	Opt.	√	√	
MS2663C	9 kHz to 8.1 GHz	-115 to +30	1 kHz to 3 MHz, 30 Hz to 3 MHz (with Opt.)	√	-100	-75	-80	√	√	√	Opt.	Opt.	Opt.	Opt.	Opt.	√	√	
MS2665C	9 kHz to 21.2 GHz	-115 to +30	1 kHz to 3 MHz, 30 Hz to 3 MHz (with Opt.)	√	-95 ^{*3}	-60	-80	√	√	√	Opt.	Opt.	Opt.	-	-	√	√	
MS2667C	9 kHz to 30 GHz	-115 to +30	1 kHz to 3 MHz, 10 Hz to 3 MHz (with Opt.)	√	-95 ^{*3}	-60	-80	√	√	√	Opt.	Opt.	Opt.	-	-	√	√	
MS2668C	9 kHz to 40 GHz	-115 to +30	1 kHz to 3 MHz, 10 Hz to 3 MHz (with Opt.)	√	-90 ^{*3}	-90	-75	√	√	√	Opt.	Opt.	Opt.	Opt.	-	√	√	
MS2683A	9 kHz to 7.8 GHz	-124 to +30	300 Hz to 3 MHz, 1 Hz to 1 MHz (with Opt.)	√	-108 ^{*1}	-90	-85	√	√	√	-	-	√	√	-	√	-	
MS2711A	100 kHz to 3 GHz	-90 to +20	10 kHz to 1 MHz	√	-74 ^{*4}	-45	-45	-	√	-	√	-	-	-	-	RS-232	-	

*1: 10 kHz offset

*2: At -30 dBm

*3: $-95 + 20 \log n$ (n: local harmonic order)

*4: At 30 kHz offset

SPECTRUM ANALYZER
MS2683A
9 kHz to 7.8 GHz

For Evaluation of IMT-2000, Bluetooth™, MMAC, and Advanced Radio Communication Devices

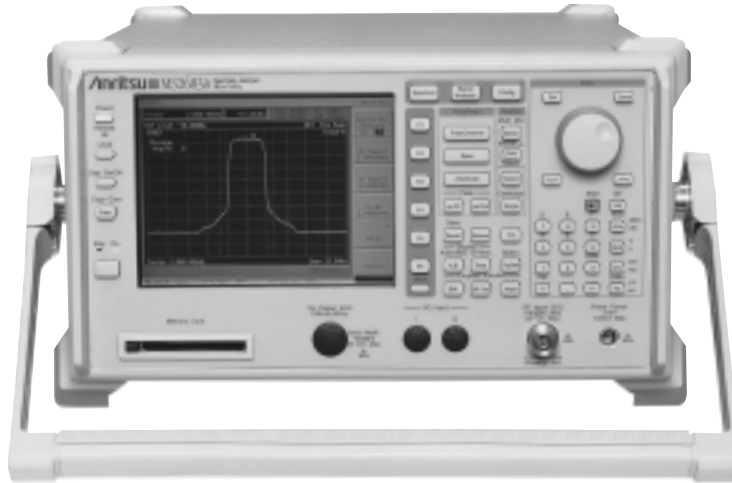

6

Third-generation mobile radio communication systems conforming to IMT-2000 (2 GHz band) will soon enter service and the *Bluetooth* system (2.4 GHz) is also being adopted for short-range radio communications by mobile terminals and peripheral devices. R&D in many countries is focused on MMAC, IEEE802.11a, and Hyper LAN2 (5 GHz band) that allow high-speed radio access to the Internet. The MS2683A has been designed to provide the optimum performance required for evaluation of these advanced radio communication devices. It has a wide dynamic range (156 dB typ.), wide

resolution bandwidth (20 MHz), and high-speed sweep (refresh rate: 20 times/s). The input attenuator can be set in 2 dB steps, permitting reduction of the analyzer mixer distortion and intrinsic noise.

Features

- Wide-resolution bandwidth (20 MHz)
- Low average noise level (≤ -146 dBm/Hz, 1 MHz to 3.2 GHz)
- High-speed sweep (20 times/s)

Specifications

Specified values were obtained after warming up the equipment for 30 minutes at a constant ambient temperature and then performing calibration. Typical and nominal values are given for reference, and are not guaranteed.

Frequency	Frequency range	9 kHz to 7.8 GHz
	Frequency band	Band 0: 9 kHz to 3.2 GHz, Band 1-L: 1.6 to 3.2 GHz (Option 03), Band 1-: 3.15 to 6.3 GHz, Band 1+: 6.2 to 7.8 GHz
	Preselector range	3.15 to 7.8 GHz, 1.6 to 7.8 GHz (Option 03)
	Display frequency accuracy	\pm (display frequency x reference frequency accuracy + span x span accuracy + RBW x 0.15 + 10 Hz)
	Frequency span	Setting range: 0 Hz, 5 kHz to 7.8 GHz, Accuracy: $\pm 1\%$ (single band sweep)
	Resolution bandwidth (RBW) [3 dB BW]	Setting range: 300 Hz to 3 MHz (1, 3 sequence) 5, 10, 20 MHz (0 Band only) *Manually settable, or automatically settable according to frequency span Bandwidth accuracy: $\pm 20\%$ (300 Hz to 10 MHz), $\pm 40\%$ (20 MHz) Selectivity (60 dB: 3 dB): $\leq 15:1$
	Video bandwidth (VBW)	1 Hz to 3 MHz (1, 3 sequence), off *Manually settable, or automatically settable according to RBW
	Signal purity	Single sideband noise: ≤ -108 dBc/Hz (1 GHz, 10 kHz offset), ≤ -120 dBc/Hz (1 GHz, 100 kHz offset)
Amplitude	Reference oscillator	Frequency: 10 MHz Start-up characteristics: $\leq 5 \times 10^{-8}$ (after 10-minute warm-up, referenced to frequency after 24 hour warm-up) Aging rate: $\leq 2 \times 10^{-8}$ /day; $\leq 1 \times 10^{-7}$ /year (referenced to frequency after 24 hour warm-up) Temperature characteristics: $\pm 5 \times 10^{-8}$ (0° to 50°C, referenced to frequency at 25°C)
	Level measurement	Measurement range: Average noise level to +30 dBm Maximum input level CW average power: +30 dBm (RF ATT: ≥ 10 dB) Peak pulse: +47 dBm (pulse width: $\leq 1 \mu$ s, duty ratio: $\leq 1\%$, RF ATT: ≥ 30 dB) DC Voltage: 0 Vdc Displayed average noise level: ≤ -124 dBm + f [GHz] dB (1 MHz to 3.2 GHz, Band 0), ≤ -122 dBm + 0.5f [GHz] dB (3.15 to 7.8 GHz, Band 1) *RBW: 300 Hz, VBW: 1 Hz, RF ATT: 0 dB Residual response: ≤ -100 dBm (1 MHz to 3.2 GHz, Band 0), ≤ -90 dBm (3.15 to 7.8 GHz, Band 1)

Continued on next page

Amplitude	Reference level	<p>Setting range Log scale: -100 to +40 dBm, Linear scale: 2.24 μV to 22.4 V</p> <p>Units Log scale: dBm, dBμV, dBmV, dBμV (emf), W, V, dBμV/m Linear scale: V</p> <p>Reference level accuracy: ± 0.5 dB (-49.9 to 0 dBm), ± 0.75 dB (-69.9 to -50 dBm, 0.1 to +30 dBm), ± 1.5 dB (-80 to -70 dBm) *After calibration, 50 MHz, span: 1 MHz. When RF ATT, RBW, VBW and sweep time set to AUTO. RBW Switching uncertainty: ± 0.3 dB (300 Hz to 5 MHz), ± 0.5 dB (10, 20 MHz) *After calibration, referenced to RBW: 3 kHz Input attenuator (RF ATT) Setting range: 0 to 62 dB (2 dB steps) *Manual settable, or automatically settable according to reference level Accuracy: ± 0.3 dB (10 to 50 dB), ± 0.5 dB (52 to 62 dB) *Frequency: 100 MHz, referenced to RF ATT: 10 dB Input attenuator switching mode: 2, 10 dB step mode</p>
	Frequency response	<p>± 0.6 dB (9 kHz to 3.2 GHz, Band 0, refer to 50 MHz, RF ATT: 10 dB, 18° to 28°C) ± 1.0 dB (3.15 to 7.8 GHz, Band 1, refer to 50 MHz, RF ATT: 10 dB, 18° to 28°C) ± 1.0 dB (Option 03, 1.6 to 7.8 GHz, Band 1, refer to 50 MHz, RF ATT: 10 dB, 18° to 28°C) ± 1.0 dB (9 kHz to 3.2 GHz, Band 0, refer to 50 MHz, RF ATT: 10 to 62 dB) ± 2.0 dB (3.15 to 7.8 GHz, Band 1, refer to 50 MHz, RF ATT: 10 to 62 dB) ± 2.0 dB (Option 03, 1.6 to 7.8 GHz, Band 1, refer to 50 MHz, RF ATT: 10 to 62 dB) *Band 1: after pre-selector tuning</p>
	Waveform display	<p>Scale: 10 div (single scale) Log scale: 10, 5, 2, 1 dB/div Linear scale: 10, 5, 2, 1%/div Linearity (after calibration) Log scale: ± 0.4 dB (0 to -20 dB, RBW: ≤ 1 kHz), ± 1.0 dB (0 to -90 dB, RBW: ≤ 1 kHz) Linear scale: $\pm 4\%$ (compared to reference level) Marker level resolution Log scale: 0.01 dB, Linear scale: 0.02%</p>
	Spurious response	<p>2nd harmonic distortion: ≤ -60 dBc (100 to 200 MHz, mixer input: -30 dBm), ≤ -75 dBc (200 to 850 MHz, Band 0, mixer input: -30 dBm), ≤ -70 dBc (0.85 to 1.6 GHz, Band 0, mixer input: -30 dBm), ≤ -90 dBc (1.6 to 3.9 GHz, Band 1, mixer input: -10 dBm), ≤ -90 dBc (Option 03, 0.8 to 3.9 GHz, Band 1, mixer input: -10 dBm) Two signals 3rd order intermodulation distortion: ≤ -70 dBc (10 to 100 MHz), ≤ -85 dBc (0.1 to 7.8 GHz) Image response: ≤ -70 dBc Multiple response: ≤ -70 dBc (Band 1)</p>
	1 dB gain compression	≥ 0 dBm (≥ 100 MHz), $\geq +3$ dBm (≥ 500 MHz, Band 0), ≥ 0 dBm (≥ 3150 MHz, Band 1), ≥ 0 dBm (Option 03, ≥ 1600 MHz, Band 1)
	Maximum dynamic range	1 dB gain compression level to average noise level: $\geq 124 - f$ [GHz] dB (0.1 to 3.2 GHz, Band 0), ≥ 122 dB - 0.5f [GHz] dB (3.15 to 7.8 GHz, Band 1)
Frequency sweep	Sweep mode	Continuous, single
	Sweep time	Setting range: 10 ms to 1000 s (manual settable, or automatically settable according to span, RBW and VBW) Setting resolution: 5 ms (5 ms to 1 s), upper 3 digits (≥ 1 s) Accuracy: $\pm 3\%$
	Trigger switch	FREERUN, TRIGGERED
	Trigger source	Line, external (± 10 V), external (TTL), wide-band IF video
	Gate mode	Off, random sweep mode Setting range Gate delay: 0 to 65.5 ms (resolution: 1 μ s) Gate length: 2 μ s to 65.5 ms (resolution: 1 μ s) Gate end: Internal, external
	Zone sweep	Sweeps only frequency range indicated by zone marker
	Tracking sweep	Sweeps while tracking peak points within zone marker (zone sweep also possible)
Time sweep	Sweep mode	Continuous, single
	Sweep time	Setting range/resolution: 1 to 50 μ s (1, 2, 5 sequence), 100 μ s to 4.9 ms (resolution: 100 μ s), 5.0 ms to 1 s (resolution: 5 ms), 1 to 1000 s (upper 3 digits setting) Accuracy: $\pm 1\%$ (10 μ s to 1000 s)
	Trigger switch	FREERUN, TRIGGERED
	Trigger source	Line, external (± 10 V), external (TTL), wide-band IF video, video
	Trigger delay	Pre-trigger (displays waveform at previous trigger point) Setting range: - time span to 0 s Resolution: time span/500 or 100 ns, whichever larger Post trigger (displays waveform after trigger point) Setting range: 0 to 65.5 ms Resolution: 100 ns (sweep time: ≤ 4.9 ms), 1 μ s (sweep time: ≤ 5.0 ms)
Functions	Number of data points	501
	Detection mode	NORMAL, POSITIVE PEAK, NEGATIVE PEAK, SAMPLE, AVERAGE
	Display	Trace A: Displays frequency spectrum Trace B: Displays frequency spectrum Trace Time: Displays time domain waveform at center frequency Trace A/B: Displays Trace A and Trace B simultaneously. Simultaneous sweep of same frequency, alternate sweep of independent frequencies Trace A/BG: Displays frequency region to be observed (background) and object band (foreground) selected from background with zone marker simultaneously, alternate sweep Trace A/Time: Displays frequency spectrum, and time domain waveform at center frequency simultaneously, alternate sweep Trace move/calculation: A \rightarrow B, B \rightarrow A, A \leftrightarrow B, A + B \rightarrow A, A - B \rightarrow A, A - B + DL \rightarrow A
	Storage	NORMAL, VIEW, MAX HOLD, MIN HOLD, AVERAGE, CUMULATIVE, OVERWRITE

Continued on next page

Functions	Marker	<p>Single search: AUTO TUNE, PEAK → CF, SCROLL Zone marker: NORMAL, DELTA Marker → Function: MARKER → CF, MARKER → REF, MARKER → CF STEP SIZE, ΔMARKER → SPAN, ZONE → SPAN Peak search: PEAK, NEXT PEAK, MIN DIP, NEXT DIP Multimarkers Number of markers: Max. 10 (HIGHEST 10, HARMONICS, MANUAL SET)</p>
	Measurement	<p>Noise power: dBm/Hz, dBm/ch, dBμV/√Hz C/N: dBm/Hz, dBm/ch Channel power: dBm, dBm/Hz Occupied bandwidth: power N% method, X-dB down method Adjacent channel power Reference value measurement: Total power, reference and in-band level method Display: Channel designate display (2 channels x 2), graphic method Average power of burst signal: Average power in designated time range of time domain waveform Template comparison waveform: Upper limit x 2, lower limit x 2 (time domain) MASK measurement: Upper limit x 2, lower limit x 2 (frequency domain)</p>
	Correction	Any correction for frequency characteristics, 150 points max.
Others	Display	<p>VGA color LCD Size: 17 cm (6.5" type) Number of colors: 4096 (RGB, each 16-scale settable) Intensity adjustment: 5 steps (including display off) Display items: Scale, waveform data, setting conditions, menu, title</p>
	Save/recall	Save and recall setting conditions and waveform data to internal memory (max. 12) or memory card
	Hard copy	Display data can be hard-copied to printer via parallel interface (printer: only ESC/P equivalent and HP815 compatible models)
	GPIB	<p>Meets IEEE488.2 recommendation Function: Controlled by external controller (excluding power switch) Interface functions: SH1, AH1, T6, L4, SR1, RL1, PP0, DC1, DT1, C0, E2</p>
	Parallel interface	Centronics for printer, D-sub 25-pin (jack)
	PC card interface	<p>Functions: Saving/recalling setting conditions and waveform data; ATA flash card (3.3/5 V) Connector: Type I or Type II PC card</p>
I/O connector	<p>RF input Connector: N-J, 50 Ω Impedance (VSWR): ≤1.5 (typ., RF ATT: ≥10 dB) IF output Connector: BNC, 50 Ω (nominal) Frequency: 66, 10.69 MHz Level: -10 dBm (typ., 50 MHz, top of display scale, 50 Ω termination) Wide-band IF output Connector: BNC, 50 Ω (nominal) Frequency: 60.69, 66 MHz Gain: 0 dB (typ., 50 MHz, RF ATT: 0 dB, at RF input level) Video output (Y) Connector: BNC Level Log scale: 0 to 0.5 V ±0.1 V (typ.), Linear scale: 0 to 0.4 V ±0.1 V (typ.) *50 MHz, scale: 10 dB/div, from upper edge to lower edge at 10%/div at full scale, 75 Ω termination Video output: Analog RGB, D-sub 15-pin (jack) External reference input Connector: BNC Frequency: 10 MHz ±10 Hz, 13 MHz ±13 Hz Level: ≥0 dBm (50 Ω termination) Buffered output Connector: BNC, Frequency: 10 MHz, Level: 2 to 5 Vp-p (200 Ω termination) Sweep output (X) Connector: BNC Level: 0 to 10 ±1 V (terminated: ≥100 kΩ, from left edge to right on display scale, single band sweep) Sweep state output Connector: BNC, Level: TTL level (low level at sweep) Probe source 4-pin connector, ±12 V (each ±10%), each 110 mA (max.) Trigger/gate input Connector: BNC, Level: ±10 V (resolution: 0.1 V) or TTL level</p>	
Dimensions and mass	320 (W) x 177 (H) x 411 (D) mm (excluding handle, feet, and fan cover), ≤16 kg (nominal, without options)	
Power	100 to 120/200 to 240 Vac (-15/+10%, 250 V max., automatic voltage detected), 50/60 Hz ±5%, ≤400 VA	
Environmental conditions	Operating temperature: 0° to +50°C, Storage temperature: -20° to +60°C, Relative humidity: 85% (no condensation)	
EMC	<p>EN61326: 1997/A1, 1998 (Class A) EN61000-3-2: 1995/A2, 1998 (Class A) EN61326: 1997/A1, 1998 (Annex A)</p>	
LVD	EN610101-1: 1993/A2, 1995 (Installation Category II, Pollution degree 2)	
Others	Vibration: Meets MIL-STD-801D	

• Option 01: Precision frequency reference crystal oscillator

Frequency	10 MHz
Start-up characteristics	$\leq \pm 5 \times 10^{-8}$ (≤ 7 minutes, 25°C, typ.)
Aging rate	$\leq \pm 5 \times 10^{-10}$ /day (after power-on, referenced to frequency after 24 h)
Temperature characteristics	$\leq \pm 5 \times 10^{-10}$ (0° to 50°C, reference to 25°C)

• Option 02: Narrow resolution bandwidths (FFT)

Resolution bandwidth setting range	1 Hz to 1 kHz (1, 3 sequence)
Minimum span	100 Hz
Resolution bandwidth switching uncertainty	± 0.5 dB
Resolution bandwidth accuracy	$\pm 7\%$ (RBW = 1, 3, 10, 100 kHz typical), $\pm 10\%$ (RBW = 1, 3, 10, 100 kHz typical)
Selectivity (60 dB : 3 dB)	$\leq 5 : 1$
Average noise level	[Without Option 08] ≤ -146.5 dBm + f [GHz] dB (1 MHz to 2.5 GHz, typical), ≤ -142.5 dBm + f [GHz] dB (2.5 to 3.2 GHz, typical), ≤ -144.5 dBm + 0.5 x f [GHz] dB (3.15 to 7.8 GHz, band 1, typical) [With Option 08] ≤ -144.5 dBm + 1.5 x f [GHz] dB (1 MHz to 2.5 GHz, band 0, typical), ≤ -142.5 dBm + f [GHz] dB (2.5 to 3.2 GHz, band 0, typical), ≤ -144.5 dBm + 0.5 x f [GHz] dB (3.15 to 7.8 GHz, band 1, typical)

• Option 03: Extension of preselector lower limit to 1.6 GHz

Outline	Expands lower frequency limit of pre-selector from 3.15 GHz to 1.6 GHz
Frequency band	0 Band: 9 kHz to 3.2 GHz, 1-L Band: 1.6 to 3.2 GHz, 1- Band: 3.15 to 6.3 GHz, 1+ Band: 6.2 to 7.8 GHz
Pre-selector range	1.6 to 7.8 GHz (band: 1-L, 1-, 1+)
Average noise level	≤ -122 dBm + 0.5f [GHz] dB (1.6 to 7.8 GHz, Band 1, RBW: 300 Hz, VBW: 1 Hz, RF ATT: 0 dB)
Residual response	≤ -90 dBm (1.6 to 7.8 GHz, Band 1, RF ATT: 0 dB, input: 50 Ω termination)
Frequency response	± 1.0 dB (1.6 to 7.8 GHz, Band 1, referenced to 50 MHz, RF ATT: 10 dB, 18° to 28°C) ± 2.0 dB (1.6 to 7.8 GHz, Band 1, RF ATT: 10 to 62 dB) *Band 1: After tuning pre-selector
2nd harmonic distortion	≤ -90 dBc (0.8 to 3.9 GHz, Band 1, mixer input: -10 dBm)
1 dB gain compression	≥ 0 dBm (1.6 to 7.8 GHz, Band 1)
Maximum dynamic range	≥ 122 dB - 0.5f [GHz] dB (1.6 to 7.8 GHz, Band 1)

• Option 04: Digital resolution bandwidth

Detection mode	Normal, positive peak, negative peak, sample, rms (rms: displays average power within burst between sample points)
Resolution bandwidth (RBW)	Range: 10 Hz to 1 MHz (1, 3 sequence) Switching deviation: ± 0.5 dB Accuracy: $\pm 10\%$ (RBW: ≥ 100 Hz), $\pm 10\%$ (RBW: ≤ 30 Hz) *Typical Selectivity (60 dB: 3 dB): $\leq 5 : 1$ (RBW: ≥ 100 Hz), $\geq 5 : 1$ (RBW: ≤ 30 Hz) *Typical
Average power within burst display	Resolution bandwidth: 10 Hz (RF ATT: 0 dB) [without Option 08] ≤ -136.5 dBm + f [GHz] dB (typ., 1 MHz to 2.5 GHz, Band 0), ≤ -132.5 dBm + f [GHz] dB (typ., 2.5 to 3.2 GHz, Band 0), ≤ -134.5 dBm + 0.5 x f [GHz] dB (typ., 3.15 to 7.8 GHz, Band 1) [with Option 08] ≤ -134.5 dBm + 1.5 x f [GHz] dB (typ., 1 MHz to 2.5 GHz, Band 0), ≤ -130.5 dBm + 1.5 x f [GHz] dB (typ., 2.5 to 3.2 GHz, Band 0), ≤ -134.5 dBm + 0.5 x f [GHz] dB (typ., 3.15 to 7.8 GHz, Band 1)
Span	Range: 0 Hz, 1 kHz to 7.9 GHz

• Option 08: Pre-amplifier*1

Frequency range	100 kHz to 3 GHz
Gain	20 dB (typ.)
Noise figure	6.5 dB (typ., ≤ 2 GHz), 12 dB (typ., > 2 GHz)
Level measurement	Level meas. range: Average noise level to +10 dBm Max. input level: +10 dBm Average noise level: -137 dBm + 2.0 x f [GHz] dB (1 MHz to 3.0 GHz, Band 0) *RBW: 300 Hz, VBW: 1 Hz, Input attenuator: 0 dB
Reference level	Setting range Log scale: -120 to +10 dBm or equivalent level Linear scale: 2.24 μ V to 707 mV Reference level accuracy: ± 0.90 dB (-69.9 to +10 dBm), ± 1.5 dB (-90 to -70 dBm) *After calibration, frequency: 50 MHz, span: 1 MHz (when RF ATT, RBW, and sweep time set to AUTO)
Resolution bandwidth switching uncertainty	± 0.5 dB (300 Hz to 5 MHz), ± 0.75 dB (10 MHz, 20 MHz) *After calibration, RBW: 3 kHz as reference
Input attenuation switching uncertainty	± 0.5 dB (10 to 50 dB), ± 0.75 dB (52 to 62 dB) *Frequency: 50 MHz, input attenuator: 10 dB as reference
Frequency response	± 2.0 dB (100 kHz to 3 GHz) *50 MHz reference, input attenuator: 10 to 50 dB, 18° to 28°C

Continued on next page

Waveform display linearity	Log scale: ±0.5 dB (0 to -20 dB, RBW: ≤1 kHz), ±1.0 dB (0 to -60 dB, RBW: ≤1 kHz), ±1.5 dB (0 to -75 dB, RBW: ≤1 kHz) Linear scale: ±5% (at reference level)
Spurious response	2 signal 3rd order distortion: -70 dBc (10 MHz to 3 GHz, frequency difference of two signal: ≥50 kHz, pre-amp input: 55 dBm*2) 1 dB gain compression: ≥-35 dBm (Input frequency: ≥100 MHz*2)

*1: At pre-amp on, above performance separately specified. Noise figure and gain are performance of pre-amp itself.

*2: Pre-amp input level as follows: Pre-amp input level = RF input level – input attenuator setting

• Option 09: Ethernet interface

Control	From external controller (excluding power switch)
Connector	10 Base-T

• Option 17: I/Q balanced input*3

Connector	BNC
Impedance	1 MΩ (shunt capacity: <100 pF), 50 Ω
Input level range	Differential voltage: 0.1 to 1 Vp-p, In-phase voltage: ±2.5 V

*3: Cannot be installed at same time. Requires measurement software

• Option 18: I/Q unbalanced input*3

Connector	BNC
Impedance	1 MΩ (shunt capacity: <100 pF), 50 Ω
Input level range	Voltage: 0.1 to 1 Vp-p

*3: Cannot be installed at same time. Requires measurement software

• Option 34: 4 GHz LO output

Frequency	Range: 4 GHz, Accuracy: ± (4 GHz x reference frequency accuracy) ±1 Hz
Output level	-10 dBm typical
Spurious	≤-40 dBc typical

• Option 46: Auto power recovery

The setting of the power switch on the front panel is disabled and the power is automatically recovered after power failure. The standby switch on the back panel is used to turn the power on and off. The front-panel power switch does not have the latching function, so the MS2683A enters the standby state after power failure at power-on even when the power line recovers.

• Option 47: Rack mount (IEC)

The MS2683A can be mounted in an IEC-compliant rack mount. When using the rack mount, the tilt handles (standard accessories) should be removed.

• Option 48: Rack mount (JIS)

The MS2683A can be mounted in a JIS-compliant rack mount. When using the rack mount, the tilt handles (standard accessories) should be removed.

Ordering information

Please specify the model/order number, name, and quantity when ordering.

Model/Order No.	Name
MS2683A	Main frame Spectrum Analyzer
	Standard accessories
	Power cord, 2.6 m: 1 pc
J0996B	RS-232C cable: 1 pc
JT32MA3-NT1	PC-ATA card (32 MB): 1 pc
F0014	Fuse, 6.3 A: 1 pc
MX268001A	File Utility Software: 1 pc
W1754AE	MS2683A operation manual: 1 copy
	Measurement software
MX268301A	W-CDMA Measurement Software
MX268302A	GSM Measurement Software
	Options
MS2683A-01	Precision frequency reference oscillator (aging rate: 5 x 10 ⁻¹⁰ /day)
MS2683A-02	Narrow resolution bandwidths (FFT)
MS2683A-03	Extension of preselector lower limit to 1.6 GHz
MS2683A-04	Digital resolution bandwidth
MS2683A-08	Pre-amplifier
MS2683A-09	Ethernet interface
MS2683A-17	I/Q balanced input
MS2683A-18	I/Q unbalanced input
MS2683A-34	4 GHz LO output
MS2683A-46	Auto power recovery
MS2683A-47	Rack mount (IEC)
MS2683A-48	Rack Mount (JIS)
	Maintenance service
MS2683A-90	Extension service 3 years
MS2683A-91	Extension service 5 years
	Optional accessories
J0561	Coaxial cord (N-P · 5D-2W · N-P), 1 m
J0104A	Coaxial cord (BNC-P · RG-55/U · N-P), 1 m
J0576D	Coaxial cord (N-P · 5D-2W · N-P), 2 m
B0452A	Hard carrying case (with caster)
B0452B	Hard carrying case
J0127C	Coaxial cord (BNC-P · RG-58A/U · BNC-P), 0.5 m
J0127A	Coaxial cord (BNC-P · RG-58A/U · BNC-P), 1 m
MP612A	Fuse Holder
MP613A	Fuse Element
MA8601A	DC Block Adapter (50 Ω, ±50 Vdc)
MA2507A	DC Block Adapter (50 Ω, 9 kHz to 3 GHz, ±50 V)
J0805	DC block (N-type, Model 7003, 10 kHz to 18 GHz, Weinschel)
MP614A	50 Ω ↔ 75 Ω Impedance Transformer
MA1621A	50 Ω ↔ 75 Ω Impedance Transformer (9 kHz to 3 GHz, ±100 V)
MA1612A	Four-Point Junction Pad
J0063	Fixed attenuator for high-power measurement (30 dB, 10 W, DC to 12.4 GHz)
J0395	Fixed attenuator for high-power measurement (30 dB, 30 W, DC to 8 GHz)
J0078	Fixed attenuator for high-power measurement (Model 23-20-34, N-type, 20 dB, 10 W, DC to 18 GHz)
MA1601A	High Pass Filter (800/900 MHz band, N-type)
J0007	GPIB cable, 1 m
J0008	GPIB cable, 2 m
B0329G	Front cover (3/4MW 4U)
J0308	Coaxial cord (BNC-P · 3C-2WS · NC-3W), 1 m

SPECTRUM ANALYZER
MS2668C
 9 kHz to 40 GHz

For Measuring High-Speed Communications, such as MMAC and ITS



The MS2668C is a portable, high-performance spectrum analyzer that has various radio evaluation functions for evaluating microwave/millimeter wave devices and systems for the wireless communications market. In recent years in this market, microwave/millimeter wave band frequencies have been investigated to realize high-speed and large-capacity data communications capabilities. Local-to-multipoint-distribution systems (LMDS), multimedia-mobile-access-communication systems (MMAC) and high-speed wireless LAN are typical applications. To realize the collision avoidance of vehicles in the intelligent transport systems (ITS) market, millimeter wave band radar has been investigated. The MS2668C can be an extremely useful tool for assisting in these investigations.

Features

- Compact and lightweight (15 kg in standard configuration)
- High C/N and superior distortion characteristics
- Easy-to-use, simple operation
- Millimeter wave applications
- Options support wide range of applications

Performance and functions

• Counter with 1 Hz resolution

A full complement of frequency counter functions are provided. Resolution is as high as ± 1 Hz even at full span, and high-speed frequency measurements can be performed. The high sensitivity compared with ordinary counters makes it easy to select one signal from many and to determine its frequency.

• Radio equipment evaluation functions (“measure” functions)

A full range of functions including measurement of power levels, frequencies, adjacent channel power, and mask and time template measurements are provided for performance evaluation of radio equipment. Key operation is simple and high-speed calculations make the measurement fast and efficient.

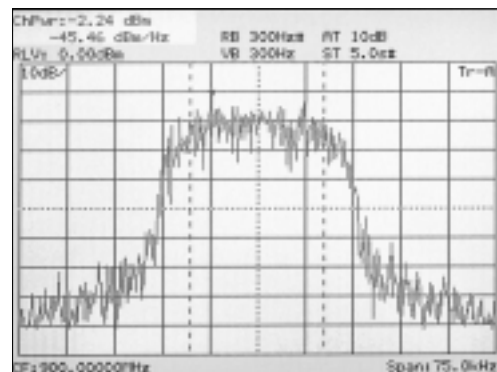

Channel power measurement

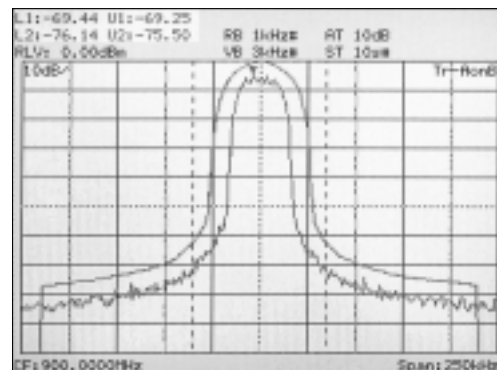

Adjacent channel power measurement

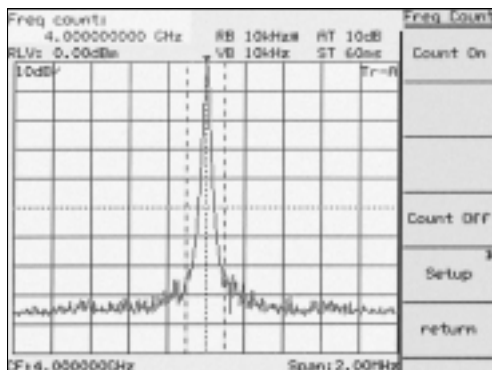

Frequency measurement (1 Hz resolution)

• **Multi-screen display**

The Trace A and Trace B waveforms are superimposed on the same screen, and two spectra with different frequencies are displayed simultaneously. In addition, it is possible to simultaneously display spectrum and time domain screens for the same signal. The multi-screen display permits efficient signal level adjustment and harmonic distortion measurement, too.

In addition to being able to display amplitude in the time domain, it is possible to display the FM demodulation waveform.

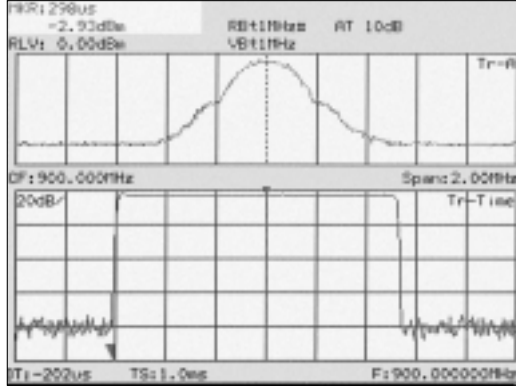

Spectrum and time domain measurement

• **For testing digital mobile communication equipment**

High-speed time domain sweep (Option 04)

Testing of TDMA-type radio equipment requires time domain (zero-span) measurements of antenna power, transient response characteristics of burst transmissions, transmission timing, and other characteristics. The high-speed time domain sweep option boosts sweep time to 12.5 μ s and resolution to 0.025 μ s. This option must be used with the trigger/gate circuit (Option 06).

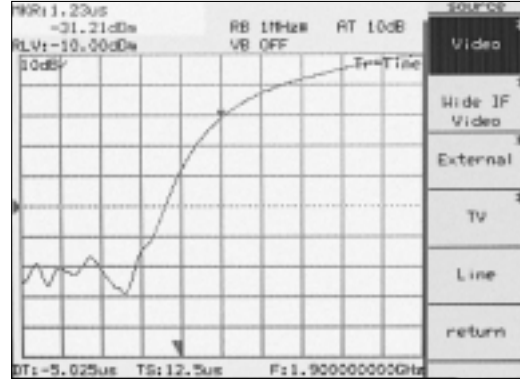

High-speed time domain measurement (TS = 12.5 μ s)

Specifications

Except where noted otherwise, specified values were obtained after warming up the equipment for 30 minutes at a constant ambient temperature and then performing calibration. The typical values are given for reference and are not guaranteed.

Frequency	Frequency range	9 kHz to 40 GHz
	Frequency band	Band 0: 0 kHz to 3.2 GHz (n = 1), Band 1-: 3.1 to 5.6 GHz (n = 1), Band 1+: 5.4 to 8.1 GHz (n = 1), Band 1+: 8.0 to 14.3 GHz (n = 2), Band 2-: 14.1 to 26.5 GHz (n = 4), Band 3-: 26.2 to 40 GHz (n = 6) *n: local harmonic order
	Pre-selector range	3.1 to 40 GHz
	Frequency setting resolution	(1 x n) Hz *n: local harmonic order
	Frequency display accuracy	\pm (display frequency x reference frequency accuracy + span x span accuracy)
	Marker frequency display accuracy	Normal marker: Same as display frequency accuracy Delta marker: Same as frequency span accuracy
	Frequency counter	Resolution: 1 Hz, 10 Hz, 100 Hz, 1 kHz Accuracy: Display frequency x reference frequency accuracy \pm 1 LSD (at S/N: \geq 20 dB)
	Frequency span	Setting range: 0 Hz, (100 x n) Hz to 40.0 GHz *n: local harmonic order Accuracy: \pm 5%
	Resolution bandwidth (RBW) (3 dB bandwidth)	Setting range: 1 kHz, 3 kHz, 10 kHz, 30 kHz, 100 kHz, 300 kHz, 1 MHz, 3 MHz (manually settable, or automatically settable according to frequency span) Option 02: 30 Hz, 100 Hz, and 300 Hz are added Option 03: 10, 30, 100, 300 Hz are added Bandwidth accuracy: \pm 20% (1 kHz to 1 MHz), \pm 30% (3 MHz) Selectivity (60 dB : 3 dB): \leq 15:1
	Video bandwidth (VBW)	1 Hz to 3 MHz (1-3 sequence), OFF *Manually settable, or automatically settable according to RBW
Signal purity and stability	Noise sidebands: \leq -95 dBc/Hz + 20 log n (1 MHz to 40 GHz, 10 kHz offset) *n: local harmonic order Residual FM: \leq 20 Hzp-p/0.1 s (1 GHz, span: 0 Hz) Frequency drift: \leq 200 x n Hz/min (span: \leq 10 kHz, sweep time: \leq 100 s) *After 1-hour warm-up at constant ambient temperature; n: local harmonic order	
Reference oscillator	Frequency: 10 MHz Start-up characteristics: \leq 5 x 10 ⁻⁸ /year (after 10 minutes warm-up, referenced to frequency after 24 hours warm-up) Aging rate: \leq 1 x 10 ⁻⁷ /year, \leq 1 x 10 ⁻⁸ /day Temperature characteristics: \pm 5 x 10 ⁻⁸ (0° to 50°C, referenced to frequency at 25°C)	
Level measurement	Measurement range: Average noise level to +30 dBm Maximum input level: +30 dBm (CW average power, RF ATT: \geq 10 dB), \pm 0 Vdc Average noise level: \leq -115 dBm (1 MHz to 1 GHz), \leq -115 dBm + 1.5f [GHz] dB (1 to 3.1 GHz), \leq -114 dBm (3.1 to 8.1 GHz), \leq -113 dBm (8.0 to 14.3 GHz), \leq -105 dBm (14.1 to 26.5 GHz), \leq -101 dBm (26.2 to 40 GHz) *RBW: 1 kHz, VBW: 1 Hz, RF ATT: 0 dB Residual response: \leq -90 dBm (RF ATT: 0 dB, input: 50 Ω terminated, 1 MHz to 8.1 GHz)	

Continued on next page

Frequency	Reference level	<p>Setting range Log scale: -100 to +30 dBm, Linear scale: 224 μV to 7.07 V</p> <p>Unit Log scale: dBm, dBμV, dBmV, V, dBμVemf, W Linear scale: V</p> <p>Reference level accuracy: ± 0.4 dB (-49.9 to 0 dBm), ± 0.75 dB (-69.9 to -50 dBm, 0.1 to +30 dBm), ± 1.5 dB (-80 to -70 dBm) *After calibration, at 100 MHz, span: 1 MHz (when RF ATT, RBW, VBW, and sweep time set to AUTO)</p> <p>RBW switching uncertainty: ± 0.3 dB (1 kHz to 1 MHz), ± 0.4 dB (3 MHz) *After calibration, referenced to RBW: 3 kHz</p> <p>Input attenuator (RF ATT) Setting range: 0 to 70 dB (10 dB steps) *Manual settable, or automatically settable according to reference level</p> <p>Switching uncertainty: ± 0.3 dB (0 to 50 dB), ± 1.0 dB (0 to 70 dB) *After calibration, frequency: 100 MHz, referenced to RF ATT: 10 dB</p>
	Frequency response	<p>Relative: ± 1.5 dB (9.0 kHz to 3.2 GHz), ± 1.0 dB (100 kHz to 3.2 GHz), ± 1.5 dB (3.1 to 8.1 GHz), ± 3.0 dB (8.0 to 14.3 GHz), ± 4.0 dB (14.1 to 26.5 GHz), ± 4.0 dB (26.2 to 40 GHz)</p> <p>*After pre-selector tuning at microwave band, referenced to midpoint between highest and lowest frequency deviation in each band.</p> <p>Absolute: ± 5.0 dB (9 kHz to 40 GHz, RF ATT: 10 dB, referenced to 100 MHz) *After pre-selector tuning at microwave band</p>
Amplitude	Waveform display	<p>Scale (10 div.) Log scale: 10, 5, 2, 1 dB/div Linear scale: 10, 5, 2, 1%/div</p> <p>Linearity (after calibration) Log scale: ± 0.4 dB (0 to -20 dB, RBW: ≤ 1 MHz), ± 1.0 dB (0 to -70 dB, RBW: ≤ 100 kHz), ± 1.5 dB (0 to -85 dB, RBW: ≤ 3 kHz), ± 2.5 dB (0 to -90 dB, RBW: ≤ 3 kHz)</p> <p>Linear scale: $\pm 4\%$ (compared to reference level)</p> <p>Marker level resolution Log scale: 0.01 dB, Linear scale: 0.02% of reference level</p>
	Spurious response	<p>2nd harmonic distortion: ≤ -60 dBc (10 to 200 MHz, mixer input: -30 dBm), ≤ -70 dBc (0.2 to 1.55 GHz, mixer input: -30 dBm), ≤ -90 dBc or noise level (1.55 to 20 GHz, mixer input: -10 dBm)</p> <p>Two signal 3rd order intermodulation distortion: ≤ -70 dBc (10 to 100 MHz), ≤ -80 dBc (0.1 to 8.1 GHz), ≤ -75 dBc or average noise level (8.1 to 26.5 GHz), ≤ -75 dBc or average noise level (typical, 26.5 to 40 GHz)</p> <p>*Frequency difference of two signals: ≥ 50 kHz, mixer input: -30 dBm</p> <p>Image response: ≤ -65 dBc (≤ 18 GHz), ≤ -60 dBc (≤ 22 GHz), ≤ -55 dBc (≤ 40 GHz)</p> <p>Multiple/out of band response: ≤ -70 dBc (≤ 14 GHz), ≤ -60 dBc (≤ 26 GHz), ≤ -55 dBc (≤ 40 GHz)</p>
	1 dB gain compression	≥ -5 dBm (≥ 100 MHz, at mixer input)
	Sweep time	<p>Setting range: 20 ms to 1000 s (manually settable, or automatically settable according to span, RBW, and VBW)</p> <p>Accuracy: $\pm 15\%$ (20 ms to 100 s), $\pm 25\%$ (110 to 1000 s), $\pm 1\%$ (time domain sweep: digital zero span mode)</p>
Sweep	Sweep mode	Continuous, single
	Time domain sweep mode	Analog zero span, digital zero span
	Zero sweep	Sweeps only in frequency range indicated by zone marker.
	Tracking sweep	Sweeps while tracing peak points within zone marker (zone sweep also possible).
	Number of data points	501
Functions	Detection mode	<p>NORMAL: Simultaneously displays max. and min. points between sample points.</p> <p>POS PEAK: Displays max. point between sample points.</p> <p>NEG PEAK: Displays min. point between sample points.</p> <p>SAMPLE: Displays momentary value at sample points.</p> <p>Detection mode switching uncertainty: ± 0.5 dB (at reference level)</p>
	Display	Color TFT-LCD, Size: 14 cm, Number of colors: 17 (RGB, each 64-scale settable), Intensity adjustment: 5 steps settable
	Display functions	<p>Trace A: Displays frequency spectrum.</p> <p>Trace B: Displays frequency spectrum.</p> <p>Trace Time: Displays time domain waveform at center frequency.</p> <p>Trace A/B: Displays Trace A and Trace B simultaneously. Simultaneous sweep of same frequency, alternate sweep of independent frequencies.</p> <p>Trace A/BG: Displays frequency region to be observed (background) and object band (foreground) selected from background with zone marker simultaneously.</p> <p>Trace A/Time: Displays frequency spectrum, and time domain waveform at center frequency simultaneously.</p> <p>Trace move/calculation: A \rightarrow B, B \rightarrow A, A \leftrightarrow B, A + B \rightarrow A, A - B \rightarrow A, A - B + DL \rightarrow A</p>
	Storage functions	NORMAL, VIEW, MAX HOLD, MIN HOLD, AVERAGE, CUMULATIVE, OVER WRITE
	FM demodulation waveform display function	<p>Demodulation range: 2, 5, 10, 20, 50, 100, 200 kHz/div</p> <p>Marker display Accuracy: $\pm 5\%$ of full scale (referenced to center frequency, DC-coupled, RBW: 3 MHz, VBW: 1 Hz, CW)</p> <p>Demodulation frequency response: DC (50 Hz at AC-coupled) to 100 kHz (range: ≤ 20 kHz/div, VBW: off, at 3 dB bandwidth) DC (50 Hz at AC-coupled) to 500 kHz (range: ≤ 50 kHz/div, VBW: off, at 3 dB bandwidth) *RBW: ≥ 1 kHz to 3 MHz usable</p>
	Input connector	K-J, 50 Ω
	Auxiliary signal input and output	<p>IF OUTPUT: -10 dBm (typical, 100 MHz, upper edge of scale, 50 Ω terminated), 10.69 MHz, BNC connector</p> <p>VIDEO OUTPUT (Y): 0 to 0.5 V \pm 0.1 V (typical, from lower edge to upper edge at 10 dB/div) 0 to 0.4 V \pm 0.1 V (typical, from lower edge to upper edge at 10%/div) BNC connector *75 Ω terminated at 100 MHz input</p> <p>COMPOSITE OUTPUT: For NTSC, 1 Vp-p (75 Ω terminated), BNC connector</p> <p>EXT REF INPUT: 10 MHz \pm 10 Hz, -10 to +2 dBm (50 Ω terminated), BNC connector</p> <p>REF BUFFERED OUTPUT: ≥ 0 dBm (50 Ω terminated), BNC connector</p> <p>1ST LOCAL OUTPUT: 4 to 7 GHz, $\geq +8$ dBm, 50 Ω, SMA-J connector</p>

Continued on next page

Functions	Signal search	AUTO TUNE, PEAK → CF, PEAK → REF, SCROLL
	Zone marker	NORMAL, DELTA
	Marker →	MARKER → CF, MARKER → REF, MARKER → CF STEP SIZE, Δ MARKER → SPAN, ZONE → SPAN
	Peak search	PEAK, NEXT PEAK, NEXT RIGHT PEAK, NEXT LEFT PEAK, MIN DIP, NEXT DIP
	Multimarker	Number of markers: 10 max. (HIGHEST 10, HARMONICS, MANUAL SET)
	Measure	Noise power (dBm/Hz, dBm/ch), C/N (dBc/Hz, dBc/ch), occupied bandwidth (power N% method, X-dB down method), adjacent channel power (REF: total power/reference level/in-band level method, channel designate display: 2 channels x 2 graphic display), average power of burst signal (average power in designated time range of time domain waveform), channel power (dBm, dBm/Hz), template comparison (upper/lower limits x each 2, time domain), MASK (upper/lower x each 2, frequency domain)
	Save/recall	Saves setting conditions and waveform data to internal memory (max. 12) or memory card.
	Hard copy	Printer (HP dotmatrix, EPSON dotmatrix compatible models): Display data can be hard-copied via RS-232C, GPIB and Centronics (Option 10) interface. Plotter (HP-GL, GP-GL compatible models): Display data can be output via RS-232C and GPIB interface.
	PTA	Language: PTL (interpreter based on BASIC) Programming: Using external computer. Program memory: Memory card, upload/download to/from external computer Programming capacity: 192 KB Data processing: Directly accesses measurement data according to system variables, system subroutines, and system functions
	RS-232C	Outputs data to printer and plotter. Control from external computer (excluding power switch).
GPIB	Meets IEEE488.2. Controlled by external computer (excluding power switch). Or controls external equipment with PTA. Interface function: SH1, AH1, T6, L4, SR1, RL1, PP0, DC1, DT1, C1, C2, C3, C4, C28	
Correction	Automatic correction of insertion loss of MA1621A Impedance Transformer Correction accuracy (RF ATT: ≥10 dB): ±2.5 dB (9 to 100 kHz), ±1.5 dB (100 kHz to 2 GHz), ±2.0 dB (2 to 3 GHz) *Typical value	
Memory card interface	Functions: Saving/recalling measurement parameters/waveform data, uploading/downloading PTA programs; Applicable cards: SRAM, EPROM, Flash EPROM (Only SRAM writable; Card capacity: 2 MB max.) Connector: Meets the PCMCIA Rel. 2.0; 2 slots	
External mixer	Frequency	Frequency range: 18 to 110 GHz Frequency band configuration Band K: 18 to 26.5 GHz (n = 4), Band A: 26.5 to 40 GHz (n = 6), Band Q: 33 to 50 GHz (n = 8), Band U: 40 to 60 GHz (n = 9), Band V: 50 to 75 GHz (n = 11), Band E: 50 to 90 GHz (n = 13), Band W: 75 to 110 GHz (n = 16) Span setting range: 0 Hz, (100 x n) Hz to each bandwidth *n: local harmonic order
	Amplitude	Level measurement Mixer conversion loss setting range: 15 to 85 dB Maximum input level: Depends on the external mixer used Average noise level: Depends on the external mixer used Reference level setting range: -100 dBm to (-25 to M) dBm *Log scale, M: mixer conversion loss Frequency response: Depends on the external mixer used
	Input/output	Suitable mixer: 2-port mixer only (local frequency: 4 to 7 GHz, IF frequency: 689.31 MHz) Display gain: 0 ±2 dB (external mixer input: -10 dBm, when the mixer conversion loss is 15 dB)
Others	EMC	EN61326: 1997/A1, 1998 (Class A) EN61000-3-2: 1995/A2, 1998 (Class A) EN61326: 1997/A1, 1998 (Annex A)
	LVD	EN610101-1: 1993/A2, 1995 (Installation Category II, Pollution degree 2)
	Vibration	Meets the MIL-STD-810D
	Power (operating range)	85 to 132/170 to 250 Vac (automatic voltage switching), 47.5 to 63 Hz, ≤400 VA
	Dimensions and mass	320 (W) x 177 (H) x 381 (D) mm, ≤15 kg (without option)
	Ambient temperature	0° to +50°C (operate), -40° to +75°C (storage)

• **Option 02: Narrow resolution bandwidth**

Resolution bandwidth (3 dB)	30 Hz, 100 Hz, 300 Hz
Resolution bandwidth switching uncertainty	±0.4 dB (RBW 3 kHz reference)
Resolution bandwidth accuracy	±20%
Selectivity (60 dB : 3 dB)	≤15:1

• **Option 04: High-speed time domain sweep**

Sweep time	12.5 μs, 25 μs, 50 μs, 100 to 900 μs (one most significant digit settable), 1.0 to 19 ms (two upper significant digits settable)
Accuracy	±1%
Marker level resolution	Log scale: 0.1 dB Linear scale: 0.2% (relative to reference level)

• **Option 03: Narrow resolution bandwidth**

Resolution bandwidth (3 dB)	10 Hz, 30 Hz, 100 Hz, 300 Hz
Resolution bandwidth switching uncertainty	±0.4 dB (RBW 3 kHz reference)
Resolution bandwidth accuracy	±20%
Selectivity (60 dB : 3 dB)	≤15:1
Average noise level	≤-135 dBm (1 MHz to 1 GHz), ≤-135 dBm + 1.5f [GHz] dB (1 to 3.1 GHz), ≤-132 dBm (3.1 to 8.1 GHz), ≤-131 dBm (8.0 to 14.3 GHz), ≤-123 dBm (14.1 to 26.5 GHz), ≤-119 dBm (26.2 to 40 GHz) *RBW: 10 Hz, VBW: 1 Hz, RF ATT: 0 dB

• Option 06: Trigger/gate circuit

Trigger switch	FREERUN, TRIGGERED
Trigger source	EXT Trigger level: ± 10 V (resolution: 0.1 V), TTL level Trigger slope: Rise/fall Connector: BNC VIDEO Log scale: -100 to 0 dB (resolution: 1 dB) Trigger slope: Rise/fall WIDE IF VIDEO Trigger level: High, middle, or low selectable Bandwidth: ≥ 20 MHz Trigger slope: Rise/fall LINE Frequency: 47.5 to 63 Hz (line lock)
Trigger delay	Pre-trigger (displays waveform from previous max. 1 screen at trigger occurrence point) Range: $-$ time span to 0 s, Resolution: time span/500 Post trigger (displays waveform from after max. 65.5 ms at trigger occurrence point) Range: 0 to 65.5 ms, Resolution: 1 μ s
Gate sweep	In frequency domain, displays spectrum of input signal in specified gate interval. Gate delay: 0 to 65.5 ms (from trigger point, resolution: 1 μ s) Gate width: 2 μ s to 65.5 ms (from gate delay, resolution: 1 μ s)

• Option 07: AM/FM demodulator

Voice output	With internal loudspeaker and earphone connector ($\phi 3.5$ jack), adjustable volume
--------------	--

• Option 10: Centronics interface*1

Function	Outputs data to printer (Centronics standard)
Connector	D-sub 25-pin (jack)

*1: GPIB interface can not be installed simultaneously.

• Option 15: Sweep signal output

Sweep output (X)	0 to 10 V ± 1 V (≥ 100 k Ω termination, from left side to right side of display scale), BNC connector
Sweep status output (Z)	TTL level (low level with sweeping), BNC connector

• External mixer

Models	Frequency range	Flange	Max. input power
MA2740A	18 to 26.5 GHz	MIL-F-3922/68-001KM	100 mW
MA2741A	26.5 to 40 GHz	MIL-F-3922/68-001AM	100 mW
MA2742A	33 to 50 GHz	MIL-F-3922/67B-006	100 mW
MA2743A	40 to 60 GHz	MIL-F-3922/67B-007	100 mW
MA2744A	50 to 75 GHz	MIL-F-3922/67B-008	100 mW
MA2745A	60 to 90 GHz	MIL-F-3922/68B-009	100 mW
MA2746A	75 to 110 GHz	MIL-F-3922/68B-010	100 mW

Ordering information

Please specify model/order number, name, and quantity when ordering.

Model/Order No.	Name
MS2668C	Main frame Spectrum analyzer
	Standard accessories
	Power cord, 2.6 m: 1 pc
F0013	Fuse, 5 A: 2 pcs
W1335AE	MS2668C operation manual: 1 copy
B0329G	Front cover (3/4MW4U): 1 pc
	Options
MS2668C-02	Narrow resolution bandwidth
MS2668C-03	Narrow resolution bandwidth
MS2668C-04	High-speed time domain sweep
MS2668C-06	Trigger/gate circuit
MS2668C-07	AM/FM demodulator (outputs to loudspeaker or earphone connector)
MS2668C-10	Centronics interface (GPIB interface can not be used simultaneously)
MS2668C-15	Sweep signal output
	Application parts
J0911	Coaxial cord (K-P · K-P), 1 m (DC to 40 GHz, SUCOFLEX 102A)
J0912	Coaxial cord (K-P · K-P), 0.5 m (DC to 40 GHz, SUCOFLEX 102A)
34AKNF50	Coaxial adaptor (DC to 20 GHz, SWR: 1.5, ruggedized K-P · N-J)
J0322B	Coaxial cord (SMA-P · SMA-P), 1 m (DC to 18 GHz, SUCOFLEX 104)
J0561	Coaxial cord (N-P-5W · 5D-2W · N-P-5W), 1 m
J0104A	Coaxial cord (BNC-P · RG-55/U · N-P), 1 m
CSCJ-256K-SM	256 KB memory card (meets PCMCIA Rel. 2.0)
CSCJ-512K-SM	512 KB memory card (meets PCMCIA Rel. 2.0)
CSCJ-001M-SM	1024 KB memory card (meets PCMCIA Rel. 2.0)
CSCJ-002M-SM	2048 KB memory card (meets PCMCIA Rel. 2.0)
B0395A	Rack mount kit (IEC)
B0395B	Rack mount kit (JIS)
MP612A	RF Fuse Holder
MP613A	Fuse Element
J0805	DC block (Model 7003, 10 kHz to 18 GHz, ± 50 V, N-type, Weinschel product)

Model/Order No.	Name
J0910	DC block (Model 7006, 10 kHz to 18 GHz, ± 50 V, SMA-type, Weinschel product)
MA2507A	DC Block Adaptor (50 Ω , 9 kHz to 3 GHz, ± 50 V, N-type)
MA8601A	DC Block Adaptor (50 Ω , 30 kHz to 2 GHz, ± 50 V, N-type)
MA8601J	DC Block Adaptor (75 Ω , 10 kHz to 2.2 GHz, ± 50 V, NC-type)
MA1621A	50 Ω \rightarrow 75 Ω Impedance Transformer (75 Ω , 9 kHz to 3 GHz, ± 100 V, NC-type)
MP614A	50 Ω \leftrightarrow 75 Ω Impedance Transformer (10 to 1200 MHz, transformer type, NC-type)
J0007	GPIB cable, 1 m
J0008	GPIB cable, 2 m
J0742A	RS-232C cable, 1 m (for PC-98 Personal Computer and VP-600, D-sub 25-pins, straight)
J0743A	RS-232C cable, 1 m (for PC/AT compatible, D-sub 9-pins, cross)
J0064A	7 GHz band coaxial/waveguide adaptor (5.8 to 8.6 GHz, N-J · BRJ-7)
J0064C	10 GHz band coaxial/waveguide adaptor (8.2 to 12.4 GHz, N-J · BRJ-10)
J0004	Coaxial adaptor (N-P · SMA-J)
DGM010-02000EE	Coaxial cord, 2 m (N-type connector, general use)
DGM024-02000EE	Coaxial cord, 2 m (N-type connector, low-loss type)
J0063	Fixed attenuator for high power (30 dB, 10 W, DC to 12.4 GHz, N-type)
J0395	Fixed attenuator for high power (30 dB, 30 W, DC to 9 GHz, N-type)
J0078	Fixed attenuator for high power (20 dB, 10 W, DC to 18 GHz, N-type)
MP526D	High Pass Filter (400 MHz band, N-type)
MA1601A	High Pass Filter (800/900 MHz band, N-type)
MA2740A	External Mixer (18 to 26.5 GHz)
MA2741A	External Mixer (26.5 to 40 GHz)
MA2742A	External Mixer (33 to 50 GHz)
MA2743A	External Mixer (40 to 60 GHz)
MA2744A	External Mixer (50 to 75 GHz)
MA2745A	External Mixer (60 to 90 GHz)
MA2746A	External Mixer (75 to 110 GHz)
B0421A	Carrying case (hard type, with casters)
B0421B	Carrying case (hard type, without casters)
B0435A	Carrying case (soft type)

SPECTRUM ANALYZER
MS2667C
 9 kHz to 30 GHz

For Evaluating LMDS Subscriber Radio Systems



6

The MS2667C is a compact, lightweight, and low-price spectrum analyzer that covers a frequency range of 9 kHz to 30 GHz. It has superior basic performance, such as high C/N ratio, low distortion, and high frequency/level accuracies, and is easy to operate. A large selection of options is provided to handle a wide range of applications at reasonable cost.

Features

- Compact and lightweight (15 kg in standard configuration)
- High C/N and superior distortion characteristics
- Easy-to-use, simple operation
- Millimeter applications
- Options support wide range of applications

Performance and functions

• Counter with 1 Hz resolution

A full complement of frequency counter functions are provided. Resolution is as high as ± 1 Hz even at full span, and high-speed frequency measurements can be performed. The high sensitivity compared with ordinary counters makes it easy to select one signal from many and to determine its frequency.

• 100 dB display dynamic range

For measurements requiring a wide dynamic range such as adjacent channel power measurements, the MS2667C can display nearly 90 dB on a single screen.

• Highly-accurate measurement

Automatic calibration ensures a high level of accuracy. A span accuracy of 5% and 501 sampling points ensure accurate occupied frequency bandwidth and adjacent channel power measurements.

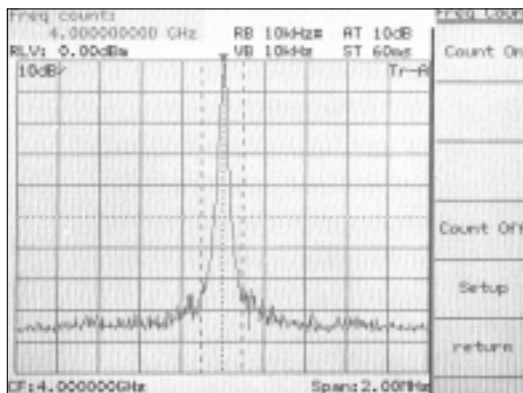

Frequency measurement (1 Hz resolution)

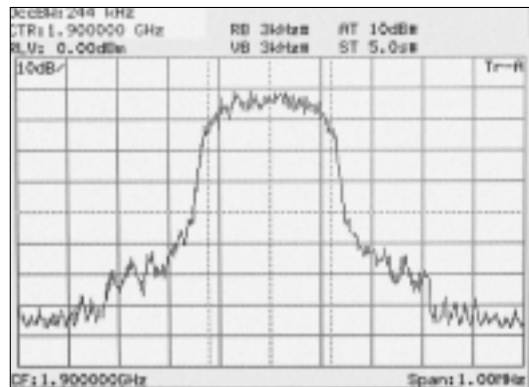

Occupied bandwidth measurement

• **Radio equipment evaluation functions (“measure” functions)**
 A full range of functions including measurement of power levels, frequencies, adjacent channel power, and mask and time template measurements are provided for performance evaluation of radio equipment. Key operation is simple and high-speed calculations make the measurement fast and efficient.

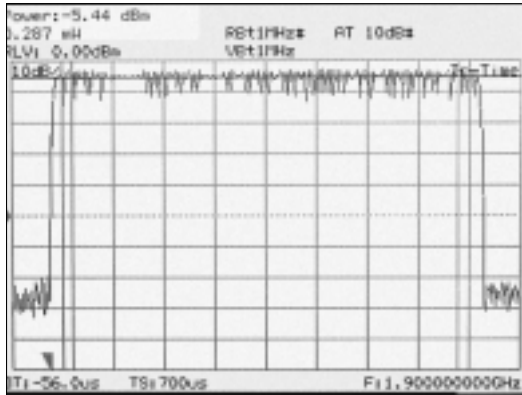

Burst average power measurement

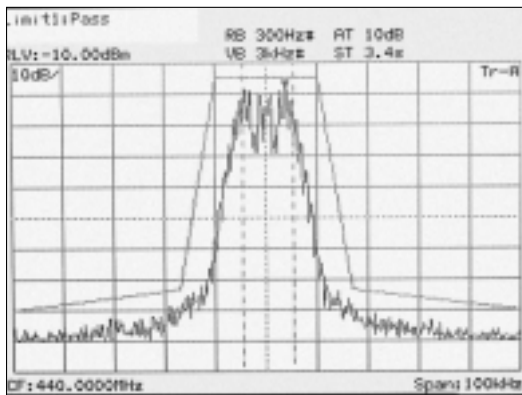

Mask measurement

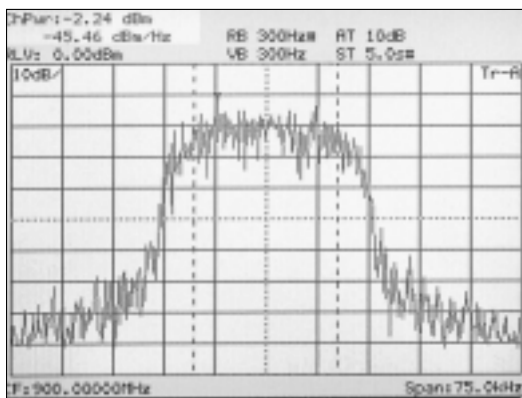

Channel power measurement

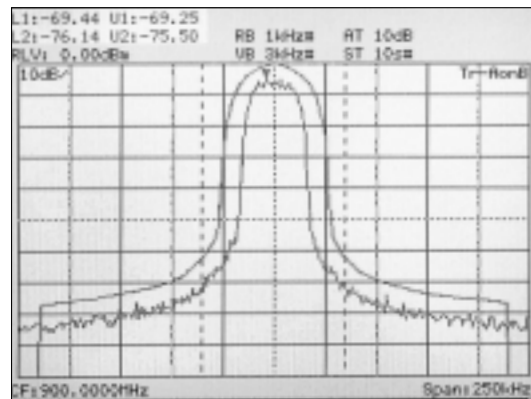

Adjacent channel power measurement

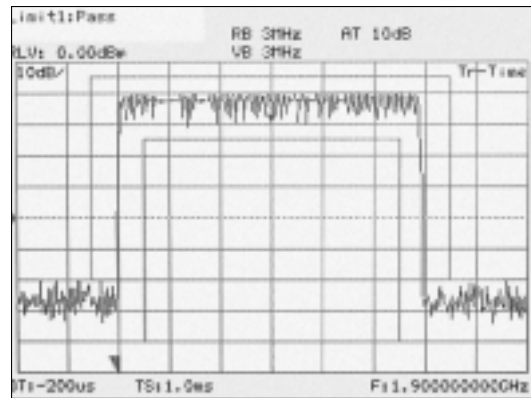

Time template measurement

• **Zone sweep and multi-zone sweep functions**

Sweeps can be limited to zones defined by zone markers which results in reduced sweep time. This zone sweep function can be combined with “measure” functions such as “noise measure,” which can directly readout the total noise power within the zone to reduce measurement time greatly. The multi-zone sweep function enables up to 10 zones to be swept.

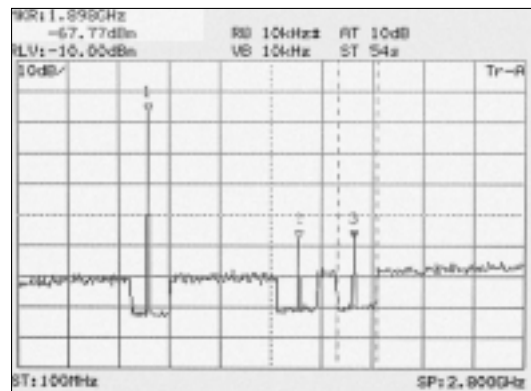

Multi-zone sweep

Specifications

Except where noted otherwise, specified values were obtained after warming up the equipment for 30 minutes at a constant ambient temperature and then performing calibration. The typical values are given for reference and are not guaranteed.

Frequency	Frequency range	9 kHz to 30 GHz
	Frequency band	Band 0: 0 to 3.2 GHz (n: 1); Band 1-: 3.1 to 6.5 GHz (n: 1); Band 1+: 6.4 to 8.1 GHz (n: 1); Band 2+: 8.0 to 15.3 GHz (n: 2); Band 3+: 15.2 to 22.4 GHz (n: 3); Band 4+: 22.3 to 30 GHz (n: 4) *n: harmonic order of the mixer
	Pre-selector range	3.1 to 30 GHz (band 1-, 1+, 2+, 3+, 4+)
	Frequency setting resolution	(1 x n) Hz *n: harmonic order of the mixer
	Frequency display accuracy	± (display frequency x reference frequency accuracy + span x span accuracy) *Span: ≥ (10 x n) kHz (n: harmonic order of the mixer, after calibration)
	Marker frequency display accuracy	Normal marker: Same as display frequency accuracy Delta marker: Same as frequency span accuracy
	Frequency counter	Resolution: 1 Hz, 10 Hz, 100 Hz, 1 kHz Accuracy: Display frequency x reference frequency accuracy ±1 LSD (at S/N: ≥20 dB)
	Frequency span	Setting range: 0 Hz, 100 Hz to 30 GHz Accuracy: ±5%
	Resolution bandwidth (RBW) (3 dB bandwidth)	Setting range: 1 kHz, 3 kHz, 10 kHz, 30 kHz, 100 kHz, 300 kHz, 1 MHz, 3 MHz (manually settable, or automatically settable according to frequency span) *Option 02 (30 Hz, 100 Hz, 300 Hz), Option 03 (10 Hz, 30 Hz, 100 Hz, 300 Hz) are added. Measurements of noise, C/N, adjacent channel power and channel power by measure function are executed with the calculated equivalent noise bandwidth of the RBW. Bandwidth accuracy: ±20% (1 kHz to 1 MHz), ±30% (3 MHz) Selectivity (60 dB : 3 dB): ≤15:1
	Video bandwidth (VBW)	1 Hz to 3 MHz (1-3 sequence), OFF *Manually settable, or automatically settable according to RBW
Signal purity and stability	Noise sidebands: ≤-95 dBc/Hz + 20 log n (1 MHz to 30 GHz, 10 kHz offset) *n: harmonic order of the mixer Residual FM: ≤20 Hzp-p/0.1 s (1 GHz, span: 0 Hz) Frequency drift: ≤200 x n Hz/min (span: ≤10 kHz x n, sweep time: ≤100 s) *After 1-hour warm-up at constant ambient temperature; n: harmonic order of the mixer	
Reference oscillator	Frequency: 10 MHz Aging rate: 1 x 10 ⁻⁷ /year, 2 x 10 ⁻⁸ /day Temperature characteristics: ±5 x 10 ⁻⁸ (0° to 50°C, referenced to frequency at 25°C)	
Amplitude	Level measurement	Measurement range: Average noise level to +30 dBm Maximum input level: +30 dBm (CW average power, RF ATT: ≥10 dB), ±0 Vdc Average noise level: ≤-115 dBm (1 MHz to 1 GHz, band 0), ≤-115 dBm + 1.5f [GHz] dB (1 to 3.1 GHz, band 0), ≤-110 dBm (3.1 to 8.1 GHz, band 1), ≤-102 dBm (8.0 to 15.3 GHz, band 2), ≤-98 dBm (15.2 to 22.4 GHz, band 3), ≤-91 dBm (22.3 to 30 GHz, band 4) *RBW: 1 kHz, VBW: 1 Hz, RF ATT: 0 dB Residual response: ≤-90 dBm (RF ATT: 0 dB, input: 50 Ω terminated, 1 MHz to 8.1 GHz)
	Reference level	Setting range Log scale: -100 to +30 dBm; Linear scale: 224 μV to 7.07 V Unit Log scale: dBm, dBμV, dBmV, V, dBμVemf, W Linear scale: V Reference level accuracy: ±0.4 dB (-49.9 to 0 dBm), ±0.75 dB (-69.9 to -50 dBm, 0.1 to +30 dBm), ±1.5 dB (-80 to -70 dBm) *After calibration, at 100 MHz, span: 1 MHz (when RF ATT, RBW, VBW and sweep time set to AUTO) RBW switching uncertainty: ±0.3 dB (1 kHz to 1 MHz), ±0.4 dB (3 MHz) *After calibration, referenced to RBW: 3 kHz Input attenuator (RF ATT) Setting range: 0 to 70 dB (10 dB steps) *Manually settable, or automatically settable according to reference level Switching uncertainty: ±0.3 dB (0 to 50 dB), ±1.0 dB (0 to 70 dB) *After calibration, frequency: 100 MHz, referenced to RF ATT: 10 dB
	Frequency response	Relative: ±1.5 dB (9 to 100 kHz, band 0), ±1.0 dB (100 kHz to 3.2 GHz, band 0), ±1.5 dB (3.1 to 8.1 GHz, band 1), ±3.0 dB (8 to 15.3 GHz, band 2), ±4.0 dB (15.2 to 22.4 GHz, band 3), ±4.0 dB (22.3 to 30 GHz, band 4) *After pre-selector tuning at band 1, 2, 3 and 4, referenced to midpoint between highest and lowest frequency deviation in each band Absolute: ±5.0 dB (9 kHz to 30 GHz, RF ATT: 10 dB, referenced to 100 MHz) *After pre-selector tuning at band 1, 2, 3 and 4
	Waveform display	Scale (10 div) Log scale: 10, 5, 2, 1 dB/div Linear scale: 10, 5, 2, 1%/div Linearity (after calibration) Log scale: ±0.4 dB (0 to -20 dB, RBW: ≤1 MHz), ±1.0 dB (0 to -70 dB, RBW: ≤100 kHz), ±1.5 dB (0 to -85 dB, RBW: ≤3 kHz), ±2.5 dB (0 to -90 dB, RBW: ≤3 kHz) Linear scale: ±4% (compared to reference level) Marker level resolution Log scale: 0.01 dB, Linear scale: 0.02% of reference level
	Spurious response	2nd harmonic distortion: ≤-60 dBc (10 to 200 MHz, band 0, mixer input: -30 dBm), ≤-70 dBc (0.2 to 1.55 GHz, band 0, mixer input: -30 dBm), ≤-90 dBc or noise level (1.55 to 15 GHz, band 1/2/3/4, mixer input: -10 dBm) Two signals 3rd order intermodulation distortion: ≤-70 dBc (10 to 100 MHz), ≤-80 dBc (0.1 to 8.1 GHz), -75 dBc or average noise level (8.1 to 26.5 GHz), ≤-75 dBc or average noise level (typical, 26.5 to 30 GHz) *Frequency difference of two signals: ≥50 kHz, mixer input: -30 dBm Image response: ≤-65 dBc (≤18 GHz), ≤-60 dBc (≤22 GHz), ≤-55 dBc (≤30 GHz) Multiple/out of band response: ≤-60 dBc (≤22 GHz), ≤-55 dBc (≤30 GHz)
	1 dB gain compression	≥-5 dBm (≥100 MHz, at mixer input)

Sweep	Sweep time	Setting range: 20 ms to 1000 s (manually settable, or automatically settable according to span, RBW and VBW) Accuracy: $\pm 15\%$ (20 ms to 100 s), $\pm 25\%$ (110 to 1000 s), $\pm 1\%$ (time domain sweep: digital zero span mode)
	Sweep mode	Continuous, single
	Time domain sweep mode	Analog zero span, digital zero span
	Zone sweep	Sweeps only in frequency range indicated by zone marker
	Tracking sweep	Sweeps while tracing peak points within zone marker (zone sweep also possible)
Functions	Number of data points	501
	Detection mode	NORMAL: Simultaneously displays max. and min. points between sample points POS PEAK: Displays max. point between sample points NEG PEAK: Displays min. point between sample points SAMPLE: Displays momentary value at sample points Detection mode switching uncertainty: ± 0.5 dB (at reference level)
	Display	Color TFT-LCD, Size: 5.5 inch, Number of colors: 17 (RGB, each 64-scale settable), Intensity adjustment: 5 steps settable
	Display functions	Trace A: Displays frequency spectrum Trace B: Displays frequency spectrum Trace Time: Displays time domain waveform at center frequency Trace A/B: Displays Trace A and Trace B simultaneously. Simultaneous sweep of same frequency, alternate sweep of independent frequencies. Trace A/BG: Displays frequency region to be observed (background) and object band (foreground) selected from background with zone marker simultaneously Trace A/Time: Displays frequency spectrum and time domain waveforms at center frequency simultaneously Trace move/calculation: A \rightarrow B, B \rightarrow A, A \leftrightarrow B, A + B \rightarrow A, A - B \rightarrow A, A - B + DL \rightarrow A
	Storage functions	NORMAL, VIEW, MAX HOLD, MIN HOLD, AVERAGE, CUMULATIVE, OVER WRITE
	FM demodulation waveform display function	Demodulation range: 2, 5, 10, 20, 50, 100, 200 kHz/div Marker display Accuracy: $\pm 5\%$ of full scale (referenced to center frequency, DC-coupled. RBW: 3 MHz, VBW: 1 Hz, CW) Demodulation frequency response: DC (50 Hz at AC-coupled) to 100 kHz (range: ≤ 20 kHz/div, VBW: off, at 3 dB bandwidth) DC (50 Hz at AC-coupled) to 500 kHz (range: ≥ 50 kHz/div, VBW: off, at 3 dB bandwidth) *RBW: ≥ 1 kHz to 3 MHz usable
	Input connector	K-J, 50 Ω
	Auxiliary signal input and output	IF OUTPUT: 10.69 MHz, BNC connector VIDEO OUTPUT (Y): 0 to 0.5 V ± 0.1 V (typical, from lower edge to upper edge at 10 dB/div), 0 to 0.4 V ± 0.1 V (typical, from lower edge to upper edge at 10%/div), BNC connector *75 Ω terminated at 100 MHz input COMPOSITE OUTPUT: For NTSC, 1 Vp-p (75 Ω terminated), BNC connector EXT REF INPUT: 10 MHz ± 10 Hz, -10 to +2 dBm (50 Ω terminated), BNC connector REF BUFFERED OUTPUT: ≥ 0 dBm (50 Ω terminated), BNC connector 1ST LOCAL OUTPUT: 4 to 7 GHz, $\geq +8$ dBm, 50 Ω , SMA-J connector
	Signal search	AUTO TUNE, PEAK \rightarrow CF, PEAK \rightarrow REF, SCROLL
	Zone marker	NORMAL, DELTA
	Marker \rightarrow	MARKER \rightarrow CF, MARKER \rightarrow REF, MARKER \rightarrow CF STEP SIZE, Δ MARKER \rightarrow SPAN, ZONE \rightarrow SPAN
	Peak search	PEAK, NEXT PEAK, NEXT RIGHT PEAK, NEXT LEFT PEAK, MIN DIP, NEXT DIP
	Multimarker	Number of markers: 10 max. (HIGHEST 10, HARMONICS, MANUAL SET)
	Measure	Noise power (dBm/Hz, dBm/ch), C/N (dBc/Hz, dBc/ch), occupied bandwidth (power N% method, X-dB down method), adjacent channel power (REF: total power/reference level/in-band level method, channel designate display: 2 channels x 2 graphic display), average power of burst signal (average power in designated time range of time domain waveform), channel power (dBm, dBm/Hz), template comparison (upper/lower limits x each 2, time domain), MASK (upper/lower x each 2, frequency domain)
	Save/recall	Saves and recalls setting conditions and waveform data to internal memory (max. 12) or memory card
	Hard copy	Printer (HP dotmatrix, EPSON dotmatrix compatible models): Display data can be hard-copied via RS-232C, GPIB, and Centronics (Option 10) interface. Plotter (HP-GL, GP-GL compatible models): Display data can be output via RS-232C and GPIB interface.
	PTA	Language: PTL (interpreter based on BASIC) Programming: Using external computer Program memory: Memory card, upload/download to/from external computer Programming capacity: 192 KB Data processing: Directly accesses measurement data according to system variables, system subroutines, and system function.
RS-232C	Outputs data to printer and plotter. Control from external computer (excluding power switch)	
GPIB	Meets IEEE488.2. Controlled by external computer (excluding power switch). Or controls external equipment with PTA Interface function: SH1, AH1, T6, L4, SR1, RL1, PP0, DC1, DT1, C1, C2, C3, C4, C28	
Correction	Automatic correction of insertion loss of MA1621A Impedance Transformer Correction accuracy (RF ATT: ≥ 10 dB): ± 2.5 dB (9 to 100 kHz), ± 1.5 dB (100 kHz to 2 GHz), ± 2.0 dB (2 to 3 GHz) *Typical value	
Memory card interface	Functions: Saving/recalling measurement parameters/waveform data, uploading/downloading PTA programs; Applicable cards: SRAM, EPROM, Flash EPROM (Only SRAM writable; Card capacity: 2 MB max.) Connector: Meets the PCMCIA Rel. 2.0, 2 slots	

Continued on next page

External mixer	Frequency	Frequency range: 18 to 110 GHz Frequency band configuration Band K: 18 to 26.5 GHz (n: 4), Band A: 26.5 to 40 GHz (n: 6), Band Q: 33 to 50 GHz (n: 8), Band U: 40 to 60 GHz (n: 9), Band V: 50 to 75 GHz (n: 11), Band E: 60 to 90 GHz (n: 13), Band W: 75 to 110 GHz (n: 16) Span setting range: 0 Hz, (100 x n) Hz to each bandwidth *n: harmonic order of the mixer
	Amplitude	Level measurement Mixer conversion loss setting range: 15 to 85 dB Maximum input level: Depends on the external mixer used Average noise level: Depends on the external mixer used Reference level setting range: -100 dBm to (-25 to M) dBm *Log scale, M: mixer conversion loss Frequency response: Depends on the external mixer used
	Input/output	Suitable mixer: 2-port mixer only (local frequency: 4 to 7 GHz, IF frequency: 689.31 MHz) Display gain: 0 ±2 dB (external mixer input: -10 dBm, when the mixer conversion loss is 15 dB)
Others	EMC	EN61326: 1997/A1, 1998 (Class A) EN61000-3-2: 1995/A2, 1998 (Class A) EN61326: 1997/A1, 1998 (Annex A)
	LVD	EN610101-1: 1993/A2, 1995 (Installation Category II, Pollution degree 2)
	Vibration	Meets the MIL-STD-810D
	Power (operating range)	85 to 132/170 to 250 Vac (automatic voltage switching), 47.5 to 63 Hz, ≤400 VA
	Dimensions and mass	320 (W) x 177 (H) x 381 (D) mm, ≤15 kg (without option)
	Ambient temperature	0° to +50°C (operate), -40° to +75°C (storage)

• Option 02: Narrow resolution bandwidth

Resolution bandwidth (3 dB)	30 Hz, 100 Hz, 300 Hz
Resolution bandwidth switching uncertainty	±0.4 dB (RBW 3 kHz referenced)
Resolution bandwidth accuracy	±20%
Selectivity (60 dB:3 dB)	≤15:1

• Option 03: Narrow resolution bandwidth

Resolution bandwidth (3 dB)	10 Hz, 30 Hz, 100 Hz, 300 Hz
Resolution bandwidth switching uncertainty	±0.4 dB (RBW 3 kHz referenced)
Resolution bandwidth accuracy	±20%
Selectivity (60 dB:3 dB)	≤15:1
Average noise level	≤-135 dBm (1 MHz to 1 GHz, band 0), ≤-135 dBm + 1.5f [GHz] dB (1 to 3.1 GHz, band 0), ≤-130 dBm (3.1 to 8.1 GHz, band 1), ≤-122 dBm (8.0 to 15.3 GHz, band 2), ≤-118 dBm (15.2 to 22.4 GHz, band 3), ≤-111 dBm (22.3 to 30 GHz, band 4) *RBW: 10 Hz, VBW: 1 Hz, RF ATT: 0 dB

• Option 04: High-speed time domain sweep

Sweep time	12.5 μs, 25 μs, 50 μs, 100 to 900 μs (one most significant digit settable) 1.0 to 19 ms (two upper significant digits settable)
Accuracy	±1%
Marker level resolution	Log scale: 0.1 dB, Linear scale: 0.2% (relative to reference level)

• Option 06: Trigger/gate circuit

Trigger switch	FREERUN, TRIGGERED
Trigger source	EXT Trigger level: ±10 V (resolution: 0.1 V), TTL level Trigger slope: Rise/fall Connector: BNC VIDEO Log scale: -100 to 0 dB (resolution: 1 dB) Trigger slope: Rise/fall WIDE IF VIDEO Trigger level: High, middle, or low selectable Bandwidth: ≥20 MHz Trigger slope: Rise/fall LINE Frequency: 47.5 to 63 Hz (line lock)
Trigger delay	Pre-trigger (displays waveform from previous max. 1 screen at trigger occurrence point) Range: -time span to 0 s, Resolution: time span/500 Post trigger (displays waveform from after max. 65.5 ms at trigger occurrence point) Range: 0 to 65.5 ms, Resolution: 1 μs
Gate sweep	In frequency domain, displays spectrum of input signal in specified gate interval Gate delay: 0 to 65.5 ms (from trigger point, resolution: 1 μs) Gate width: 2 μs to 65.5 ms (from gate delay, resolution: 1 μs)

• Option 07: AM/FM demodulator

Voice output	With internal loudspeaker and earphone connector (ø3.5 jack), adjustable volume
--------------	---

• Option 10: Centronics interface*1

Function	Outputs data to printer (Centronics standard)
Connector	D-sub 25-pin (jack)

*1: GPIB interface can not be installed simultaneously.

• Option 15: Sweep signal output

Sweep output (X)	0 to 10 V ±1 V (≥100 k Ω termination, from left side to right side of display scale), BNC connector
Sweep status output (Z)	TTL level (low level with sweeping), BNC connector

External mixer

Model	Frequency range	Mate flange	Max. input power
MA2740A	18 to 26.5 GHz	MIL-F-3922/68-001KM	100 mW
MA2741A	26.5 to 40 GHz	MIL-F-3922/68-001AM	100 mW
MA2742A	33 to 50 GHz	MIL-F-3922/67B-006	100 mW
MA2743A	40 to 60 GHz	MIL-F-3922/67B-007	100 mW
MA2744A	50 to 75 GHz	MIL-F-3922/67B-008	100 mW
MA2745A	60 to 90 GHz	MIL-F-3922/68B-009	100 mW
MA2746A	75 to 110 GHz	MIL-F-3922/68B-010	100 mW

Ordering information

Please specify model/order number, name, and quantity when ordering.

Model/order No.	Name	Model/order No.	Name
MS2667C	Main frame Spectrum Analyzer	MA2507A	DC Block Adapter (50 Ω, 9 kHz to 3 GHz, ±50 V, N-type)
	Standard accessories	MA8601A	DC Block Adapter (50 Ω, 30 kHz to 2 GHz, ±50 V, N-type)
F0013	Power cord, 2.6 m: 1 pc	MA8601J	DC Block Adapter (75 Ω, 10 kHz to 2.2 GHz, ±50 V, NC-type)
W1335AE	Fuse, 5 A: 2 pcs	MA1621A	50 Ω → 75 Ω Impedance Transformer (9 kHz to 3 GHz, ±100 V, NC-type)
B0329G	MS2665C/MS2667C operation manual: 1 copy	MP614A	50 Ω ↔ 75 Ω Impedance Transformer (10 to 1200 MHz, transformer type, NC-type)
	Front cover (3/4MW4U)	J0007	GPIB cable, 1 m
MS2667C-02	Options	J0008	GPIB cable, 2 m
MS2667C-03	Narrow resolution bandwidth	J0742A	RS-232C cable, 1 m (for PC-98 Personal Computer and VP-600, D-sub 25-pins, straight)
MS2667C-04	Narrow resolution bandwidth	J0743A	RS-232C cable, 1 m (for PC/AT compatible, D-sub 9-pins, cross)
MS2667C-06	High-speed time domain sweep	J0064A	7 GHz band coaxial/waveguide adapter (5.8 to 8.6 GHz, N-J · BRJ-7)
MS2667C-07	Trigger/gate circuit	J0064C	10 GHz band coaxial/waveguide adapter (8.2 to 12.4 GHz, N-J · BRJ-10)
MS2667C-10	AM/FM demodulator (outputs to loudspeaker or earphone connector)	J0004	Coaxial adapter (N-P · SMA-J)
MS2667C-15	Centronics interface (GPIB interface cannot be installed simultaneously)	DGM010-02000EE	Coaxial cord, 2 m (N-type connector, general use)
	Sweep signal output	DGM024-02000EE	Coaxial cord, 2 m (N-type connector, low-loss type)
34AKNF50	Application parts	J0063	Fixed attenuator for high power (30 dB, 10 W, DC to 12.4 GHz, N-type)
	Coaxial adapter (DC to 20 GHz, SWR: 1.5, ruggedized K-P · N-J)	J0395	Fixed attenuator for high power (30 dB, 30 W, DC to 9 GHz, N-type)
J0561	Coaxial cord (N-P-5W · 5D-2W · N-P-5W), 1 m	J0078	Fixed attenuator for high power (20 dB, 10 W, DC to 18 GHz, N-type)
J0104A	Coaxial cord (BNC-P · RG-55/U · N-P), 1 m	MP526D	High Pass Filter (400 MHz band)
J0322B	Coaxial cord (SMA-P · SMA-P), 1 m (DC to 18 GHz, SUCOFLEX 104A)	MA1601A	High Pass Filter (800/900 MHz band, N-type)
J0911	Coaxial cord (K-P · K-P), 1 m (DC to 40 GHz, SUCOFLEX 102A)	MA2740A	External Mixer (18 to 26.5 GHz)
J0912	Coaxial cord (K-P · K-P), 0.5 m (DC to 40 GHz, SUCOFLEX 102A)	MA2741A	External Mixer (26.5 to 40 GHz)
CSCJ-256K-SM	256 KB memory card (meets PCMCIA Rel. 2.0)	MA2742A	External Mixer (33 to 50 GHz)
CSCJ-512K-SM	512 KB memory card (meets PCMCIA Rel. 2.0)	MA2743A	External Mixer (40 to 60 GHz)
CSCJ-001M-SM	1024 KB memory card (meets PCMCIA Rel. 2.0)	MA2744A	External Mixer (50 to 75 GHz)
CSCJ-002M-SM	2048 KB memory card (meets PCMCIA Rel. 2.0)	MA2745A	External Mixer (60 to 90 GHz)
B0395A	Rack mount kit (IEC)	MA2746A	External Mixer (75 to 110 GHz)
B0395B	Rack mount kit (JIS)	B0421A	Carrying case (hard type, with casters)
MP612A	RF Fuse Holder	B0421B	Carrying case (hard type, without casters)
MP613A	Fuse Element	B0435A	Carrying case (soft type)
J0805	DC block (Model 7003, 10 kHz to 18 GHz, ±50 V, Weinschel product, N-type)		

SPECTRUM ANALYZER
MS2665C
 9 kHz to 21.2 GHz

For Evaluating ETC Subscriber Radio Systems



The MS2665C is a compact, lightweight, and low-price spectrum analyzer that covers a frequency range of 9 kHz to 21.2 GHz. It has superior basic performance such as high C/N ratio, low distortion, and high frequency/level accuracies and is easy to operate. A large selection of options is provided to handle a wide range of applications at reasonable cost.

Features

- Compact and lightweight (13 kg in standard configuration)
- High C/N and superior distortion characteristics
- Easy-to-use, simple operation
- Options support wide range of applications
- Easy-to-set up automatic measurements

Performance and functions

• Counter with 1 Hz resolution

A full complement of frequency counter functions are provided. Resolution is as high as ± 1 Hz even at full span, and high-speed frequency measurements can be performed. The high sensitivity compared with ordinary counters makes it easy to select one signal from many and to determine its frequency.

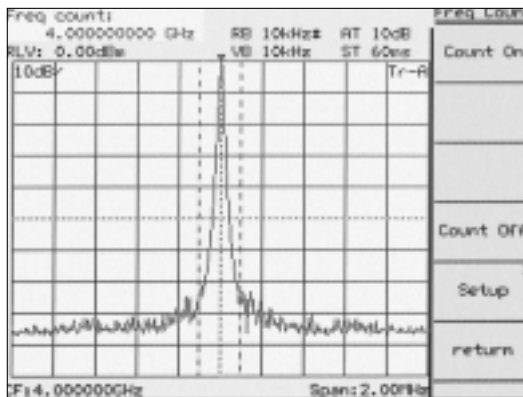

Frequency measurement (1 Hz resolution)

• 100 dB display dynamic range

For measurements requiring a wide dynamic range, such as adjacent channel power measurements, the MS2665C can display nearly 90 dB on a single screen.

• Multi-screen display

The Trace A and Trace B waveforms are superimposed on the same screen, and two spectra with different frequencies are displayed simultaneously. In addition, it is possible to simultaneously display spectrum and time domain screens for the same signal. The multi-screen display permits efficient signal level adjustment and harmonic distortion measurement, too. Furthermore, in addition to being able to display amplitude in the time domain, it is possible to display the FM demodulation waveform.

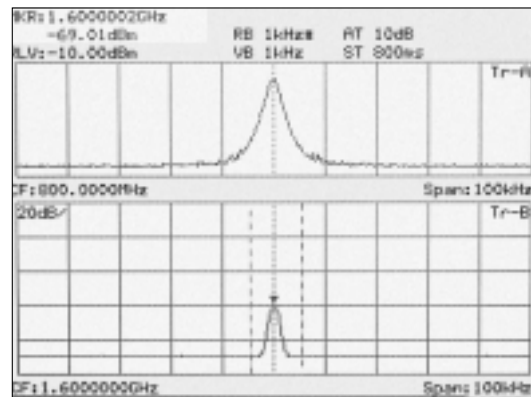

Two traces with different frequencies

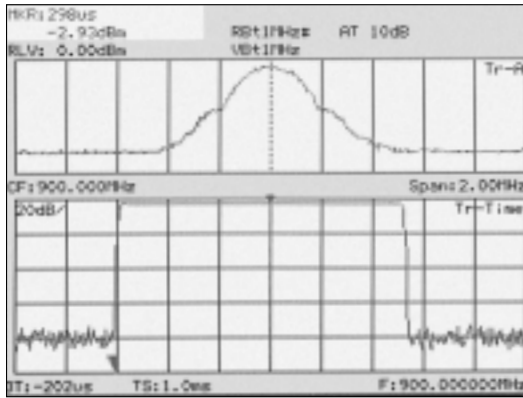

Spectrum and time domain measurement

• **For testing digital mobile communication equipment**
High-speed time domain sweep (Option 04)

Testing of TDMA-type radio equipment includes time domain (zero-span) measurements of antenna power, transient response characteristics of burst transmissions, transmission timing, and other quantities. The high-speed time domain sweep option boosts sweep time to 12.5 μ s and resolution to 0.025 μ s.

*This option must be used with the trigger/gate circuit (Option 06).

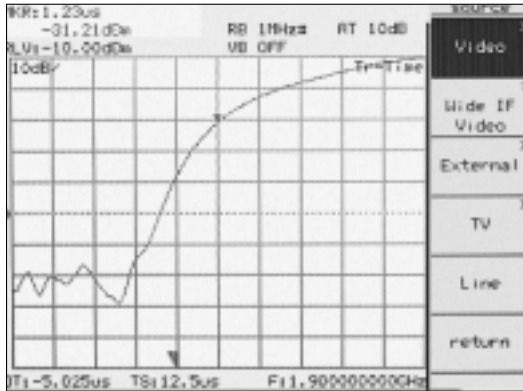

High-speed time-domain measurement (TS = 12.5 μ s)

Trigger/gate circuit (Option 06)

Burst signal can be stably measured using the trigger function in time domain measurements. One of the external, video, wide IF video, or line is selectable. This makes a variety of TDMA radio equipment tests possible, including template comparison using pre-trigger and post-trigger delay functions and gate spectrum analysis using the gate sweep function. Previously, the trigger output from an external detector was required in gate spectrum analysis. However, this option for the MS2665C has a 20 MHz wide IF video trigger function, eliminating the need for trigger output from an external detector.

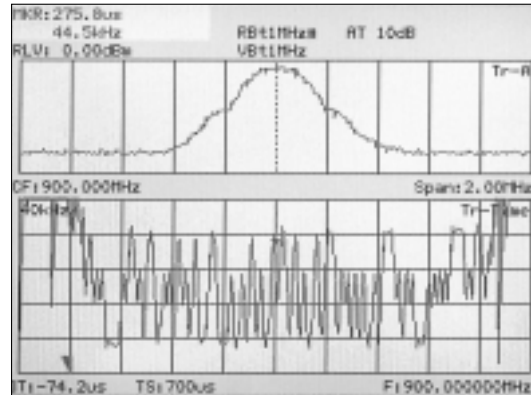

Wide IF video trigger function

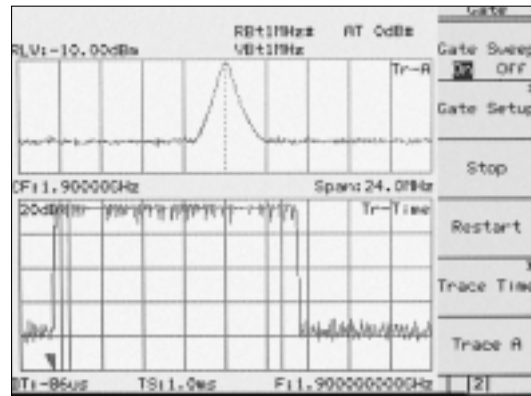

Wide IF video trigger and gate functions

Specifications

Except where noted otherwise, specified values were obtained after warming up the equipment for 30 minutes at a constant ambient temperature and then performing calibration. The typical values are given for reference and are not guaranteed.

Frequency	Frequency range	9 kHz to 21.2 GHz
	Frequency band	Band 0: 0 to 3.2 GHz (n: 1); Band 1-: 2.92 to 6.5 GHz (n: 1); Band 1+: 6.4 to 8.1 GHz(n: 1); Band 2+: 8.0 to 15.3 GHz (n: 2); Band 3+: 15.2 to 21.2 GHz (n: 3) *n: harmonic order of the mixer
	Pre-selector range	2.92 to 21.2 GHz (band 1-, 1+, 2+, 3+)
	Frequency setting resolution	Frequency domain: (1 x n) Hz, Zero span: (100 x n) Hz *n: harmonic order of the mixer
	Frequency display accuracy	\pm (display frequency x reference frequency accuracy + span x span accuracy + 100 Hz x n) *Span: \geq 10 kHz x n (n: harmonic order of the mixer, after calibration)
	Marker frequency display accuracy	Normal marker: Same as display frequency accuracy; Delta marker: Same as frequency span accuracy
	Frequency counter	Resolution: 1 Hz, 10 Hz, 100 Hz, 1 kHz Accuracy: Display frequency x reference frequency accuracy \pm 1 LSD (at S/N: \geq 20 dB)
	Frequency span	Setting range: 0 Hz, 1 kHz to 21.3 GHz Accuracy: \pm 2.5% (span: \geq 10 kHz x n), \pm 5% (span: <10 kHz x n, Option 02 installed)
	Resolution bandwidth (RBW) (3 dB bandwidth)	Setting range: 1 kHz, 3 kHz, 10 kHz, 30 kHz, 100 kHz, 300 kHz, 1 MHz, 3 MHz (manually settable, or automatically settable according to frequency span) *Option 02: 30 Hz, 100 Hz, and 300 Hz are added Measurements of noise, C/N, adjacent channel power, and channel power by measure function are executed with the calculated equivalent noise bandwidth of the RBW. Bandwidth accuracy: \pm 20% (1 kHz to 1 MHz), \pm 30% (3 MHz) Selectivity (60 dB : 3 dB) : \leq 15:1
	Video bandwidth (VBW)	1 Hz to 3 MHz (1-3 sequence), OFF *Manually settable, or automatically settable according to RBW

Continued on next page

Frequency	Signal purity, stability	Noise sidebands: ≤ -95 dBc/Hz + 20 log n (1 MHz to 21.2 GHz, 10 kHz offset) *n: harmonic order of the mixer Residual FM: ≤ 20 Hzp-p/0.1 s (1 GHz, span: 0 Hz) Frequency drift: ≤ 200 x n Hz/min (span: ≤ 10 kHz x n, sweep time: ≤ 100 s) *After 1-hour warm-up at constant ambient temperature; n: harmonic order of the mixer
	Reference oscillator	Frequency: 10 MHz Aging rate: 2×10^{-6} /year (typical); Option 01 : 1×10^{-7} /year, 2×10^{-8} /day Temperature characteristics: 1×10^{-6} (typical, 0° to 50°C); Option 01: $\pm 5 \times 10^{-8}$ (0° to 50°C, referenced to frequency at 25°C)
Amplitude	Level measurement	Measurement range: Average noise level to +30 dBm Maximum input level: +30 dBm (CW average power, RF ATT: ≥ 10 dB), ± 0 Vdc Average noise level: ≤ -115 dBm (1 MHz to 1 GHz, band 0), ≤ -115 dBm + 1.5f [GHz] dB (1 to 3.1 GHz, band 0), ≤ -110 dBm (2.92 to 8.1 GHz, band 1), ≤ -102 dBm (8.0 to 15.3 GHz, band 2), ≤ -98 dBm (15.2 to 21.2 GHz, band 3) *RBW: 1 kHz, VBW: 1 Hz, RF ATT: 0 dB Residual response: ≤ -90 dBm (RF ATT: 0 dB, input: 50 Ω terminated, 1 MHz to 8.1 GHz)
	Reference level	Setting range Log scale: -100 to +30 dBm; Linear scale: 224 μ V to 7.07 V Unit Log scale: dBm, dB μ V, dBmV, V, dB μ Vemf, W Linear scale: V Reference level accuracy: ± 0.4 dB (-49.9 to 0 dBm), ± 0.75 dB (-69.9 to -50 dBm, 0.1 to +30 dBm), ± 1.5 dB (-80 to -70 dBm) *After calibration, at 100 MHz, span: 1 MHz (when RF ATT, RBW, VBW, and sweep time set to AUTO) RBW switching uncertainty: ± 0.3 dB (1 kHz to 1 MHz), ± 0.4 dB (3 MHz) *After calibration, referenced to RBW: 3 kHz Input attenuator (RF ATT) Setting range: 0 to 70 dB (10 dB steps) *Manually settable, or automatically settable according to reference level Switching uncertainty: ± 0.3 dB (0 to 50 dB), ± 1.0 dB (0 to 70 dB) *After calibration, frequency: 100 MHz, referenced to RF ATT: 10 dB
	Frequency response	Relative: ± 1.5 dB (9 to 100 kHz, band 0), ± 1.0 dB (100 kHz to 3.2 GHz, band 0), ± 1.5 dB (2.92 to 8.1 GHz, band 1), ± 3.0 dB (8 to 15.3 GHz, band 2), ± 4.0 dB (15.2 to 21.2 GHz, band 3) *After pre-selector tuning at band 1, 2 and 3, referenced to midpoint between highest and lowest frequency deviation in each band Absolute: ± 5.0 dB (9 kHz to 21.2 GHz, RF ATT: 10 dB, referenced to 100 MHz) *After pre-selector tuning at band 1, 2 and 3, referenced to midpoint between highest and lowest frequency deviation in each band
	Waveform display	Scale (10 div) Log scale: 10, 5, 2, 1 dB/div Linear scale: 10, 5, 2, 1%/div Linearity (after calibration) Log scale: ± 0.4 dB (0 to -20 dB), ± 1.0 dB (0 to -70 dB), ± 1.5 dB (0 to -85 dB), ± 2.5 dB (0 to -90 dB) Linear scale: $\pm 4\%$ (compared to reference level) Marker level resolution Log scale: 0.01 dB; Linear scale: 0.02% of reference level
	Spurious response	2nd harmonic distortion: ≤ -60 dBc (10 to 200 MHz, band 0, mixer input: -30 dBm), ≤ -70 dBc (0.2 to 1.55 GHz, band 0, mixer input: -30 dBm), ≤ -100 dBc or noise level (1.46 to 10.6 GHz, band 1/2/3, mixer input: -10 dBm) Two signals 3rd order intermodulation distortion: ≤ -70 dBc (10 to 100 MHz), ≤ -80 dBc (0.1 to 8.1 GHz), -75 dBc or noise level (8.1 to 21.2 GHz) *Frequency difference of two signals: ≥ 50 kHz, mixer input: -30 dBm Image response: ≤ -65 dBc (≤ 18 GHz), ≤ -60 dBc (> 18 GHz) Multiple response: ≤ -60 dBc
	1 dB gain compression	≥ -5 dBm (≥ 100 MHz, at mixer input)
	Sweep	Sweep time
Sweep mode		Continuous, single
Time domain sweep mode		Analog zero span, digital zero span
Zone sweep		Sweeps only in frequency range indicated by zone marker
Tracking sweep		Sweeps while tracing peak points within zone marker (zone sweep also possible)
Functions	Number of data points	501
	Detection mode	NORMAL: Simultaneously displays max. and min. points between sample points POS PEAK: Displays max. point between sample points NEG PEAK: Displays min. point between sample points SAMPLE: Displays momentary value at sample points Detection mode switching uncertainty: ± 0.5 dB (at reference level)
	Display	Color TFT-LCD, Size: 5.5 inch, Number of colors: 17 (RGB, each 64-scale settable), Intensity adjustment: 5 steps settable
	Display functions	Trace A: Displays frequency spectrum Trace B: Displays frequency spectrum Trace Time: Displays time domain waveform at center frequency Trace A/B: Displays Trace A and Trace B simultaneously. Simultaneous sweep of same frequency, alternate sweep of independent frequencies. Trace A/BG: Displays frequency region to be observed (background) and object band (foreground) selected from background with zone marker simultaneously Trace A/Time: Displays frequency spectrum and time domain waveform at center frequency simultaneously Trace move/calculation: A \rightarrow B, B \rightarrow A, A \leftrightarrow B, A + B \rightarrow A, A - B \rightarrow A, A - B + DL \rightarrow A

Continued on next page

	Storage functions	NORMAL, VIEW, MAX HOLD, MIN HOLD, AVERAGE, CUMULATIVE, OVER WRITE	
	FM demodulation waveform display function	Demodulation range: 2, 5, 10, 20, 50, 100, 200 kHz/div Marker display Accuracy: $\pm 5\%$ of full scale (referenced to center frequency, DC-coupled. RBW: 3 MHz, VBW: 1 Hz, CW) Demodulation frequency response: DC (50 Hz at AC-coupled) to 100 kHz (range: ≤ 20 kHz/div, VBW: off, at 3 dB bandwidth) DC (50 Hz at AC-coupled) to 500 kHz (range: ≥ 50 kHz/div, VBW: off, at 3 dB bandwidth) *RBW: ≥ 1 kHz to 3 MHz usable	
	Input connector	N-J, 50 Ω	
	Auxiliary signal input and output	IF OUTPUT: 10.69 MHz, BNC connector VIDEO OUTPUT (Y): 0 to 0.5 V ± 0.1 V (typical, from lower edge to upper edge at 10 dB/div), 0 to 0.4 V ± 0.1 V (typical, from lower edge to upper edge at 10%/div), BNC connector *75 Ω terminated at 100 MHz input COMPOSITE OUTPUT: For NTSC, 1 Vp-p (75 Ω terminated), BNC connector EXT REF INPUT: 10 MHz ± 10 Hz, ≥ 0 dBm (50 Ω terminated), BNC connector	
	Signal search	AUTO TUNE, PEAK \rightarrow CF, PEAK \rightarrow REF, SCROLL	
	Zone marker	NORMAL, DELTA	
	Marker \rightarrow	MARKER \rightarrow CF, MARKER \rightarrow REF, MARKER \rightarrow CF STEP SIZE, Δ MARKER \rightarrow SPAN, ZONE \rightarrow SPAN	
	Peak search	PEAK, NEXT PEAK, NEXT RIGHT PEAK, NEXT LEFT PEAK, MIN DIP, NEXT DIP	
	Multimarker	Number of markers: 10 max. (HIGHEST 10, HARMONICS, MANUAL SET)	
Functions	Measure	Noise power (dBm/Hz, dBm/ch), C/N (dBc/Hz, dBc/ch), occupied bandwidth (power N% method, X-dB down method), adjacent channel power (REF: total power/reference level/in-band level method, channel designate display: 2 channels x 2 graphic display), average power of burst signal (average power in designated time range of time domain waveform), channel power (dBm, dBm/Hz), template comparison (upper/lower limits x each 2, time domain), MASK (upper/lower x each 2, frequency domain)	
	Save/recall	Saves and recalls setting conditions and waveform data to internal memory (max. 12) or memory card	
	Hard copy	Printer (HP dotmatrix, EPSON dotmatrix compatible models): Display data can be hard-copied via RS-232C, GPIB, and Centronics (Option 10) interface. Plotter (HP-GL, GP-GL compatible models): Display data can be output via RS-232C and GPIB interface.	
	PTA	Language: PTL (interpreter based on BASIC) Programming: Using external computer Program memory: Memory card, upload/download to/from external computer Programming capacity: 192 KB Data processing: Directly accesses measurement data according to system variables, system subroutines, and system function.	
	RS-232C	Outputs data to printer and plotter. Control from external computer (excluding power switch)	
	GPIB	Meets IEEE488.2. Controlled by external computer (excluding power switch). Or controls external equipment with PTA Interface function: SH1, AH1, T6, L4, SR1, RL1, PP0, DC1, DT1, C1, C2, C3, C4, C28	
	Correction	Automatic correction of insertion loss of MA1621A Impedance Transformer Correction accuracy (RF ATT: ≥ 10 dB): ± 2.5 dB (9 to 100 kHz), ± 1.5 dB (100 kHz to 2 GHz), ± 2.0 dB (2 to 3 GHz) *Typical value	
	Memory card interface	Functions: Saving/recalling measurement parameters/waveform data, uploading/downloading PTA programs; Applicable cards: SRAM, EPROM, Flash EPROM (Only SRAM writable; Card capacity: 2 MB max.) Connector: Meets the PCMCIA Rel. 2.0; 2 slots	
	Others	EMC	EN61326: 1997/A1, 1998 (Class A) EN61000-3-2: 1995/A2, 1998 (Class A) EN61326: 1997/A1, 1998 (Annex A)
		LVD	EN610101-1: 1993/A2, 1995 (Installation Category II, Pollution degree 2)
Vibration		Meets the MIL-STD-810D	
Power (operating range)		85 to 132/170 to 250 Vac (automatic voltage switching), 47.5 to 63 Hz, 380 to 420 Hz (85 to 132 V only), ≤ 330 VA	
Dimensions and mass		320 (W) x 177 (H) x 351 (D) mm, ≤ 13 kg (without option)	
	Ambient temperature	0° to +50°C (operate), -40° to +75°C (storage)	

• Option 01: Reference crystal oscillator

Frequency	10 MHz
Aging rate	$\leq 1 \times 10^{-7}$ /year, $\leq 2 \times 10^{-8}$ /day (after power on, with reference to frequency after 24 h)
Temperature characteristics	$\pm 5 \times 10^{-8}$ (0° to 50°C, with reference to 25°C)
Buffer output	10 MHz, > 2 Vp-p (200 Ω termination), BNC connector

• Option 02: Narrow resolution bandwidth

Resolution bandwidth (3 dB)	30 Hz, 100 Hz, 300 Hz
Resolution bandwidth switching uncertainty	± 0.4 dB (RBW 3 kHz referenced)
Resolution bandwidth accuracy	$\pm 20\%$ (100, 300 Hz)
Selectivity (60 dB:3 dB)	$\leq 15:1$ (RBW: 100, 300 Hz), $\leq 20:1$ (RBW: 30 Hz)

• Option 04: High-speed time domain sweep

Sweep time	12.5 μ s, 25 μ s, 50 μ s, 100 to 900 μ s (one most significant digit settable), 1.0 to 19 ms (two upper significant digits settable)
Accuracy	\pm 1%
Marker level resolution	Log scale: 0.1 dB; Linear scale: 0.2% (relative to reference level)

• Option 06: Trigger/gate circuit

Trigger switch	FREERUN, TRIGGERED
Trigger source	EXT Trigger level: \pm 10 V (resolution: 0.1 V), TTL level Trigger slope: Rise/fall Connector: BNC VIDEO Log scale: -100 to 0 dB (resolution: 1 dB) Trigger slope: Rise/fall WIDE IF VIDEO Trigger level: High, middle, or low selectable Bandwidth: \geq 20 MHz Trigger slope: Rise/fall LINE Frequency: 47.5 to 63 Hz (line lock)
Trigger delay	Pre-trigger (displays waveform from previous max. 1 screen at trigger occurrence point) Range: -time span to 0 s Resolution: time span/500 Post trigger (displays waveform from after max. 65.5 ms at trigger occurrence point) Range: 0 to 65.5 ms Resolution: 1 μ s
Gate sweep	In frequency domain, displays spectrum of input signal in specified gate interval Gate delay: 0 to 65.5 ms (from trigger point, resolution: 1 μ s) Gate width: 2 μ s to 65.5 ms (from gate delay, resolution: 1 μ s)

• Option 07: AM/FM demodulator

Voice output	With internal loudspeaker and earphone connector (\varnothing 3.5 jack), adjustable volume
--------------	---

• Option 10: Centronics interface*1

Function	Outputs data to printer (Centronics standard)
Connector	D-sub 25-pin (jack)

*1: GPIB interface can not be installed simultaneously.

• Option 15: Sweep signal output

Sweep output (X)	0 to 10 V \pm 1 V (\geq 100 k Ω termination, from left side to right side of display scale), BNC connector
Sweep status output (Z)	TTL level (low level with sweeping), BNC connector

Ordering information

Please specify model/order number, name, and quantity when ordering.

Model/order No.	Name
MS2665C	Main frame Spectrum Analyzer
F0013 W1335AE B0329G	Standard accessories Power cord, 2.6 m: 1 pc Fuse, 5 A: 2 pcs MS2665C/MS2667C operation manual: 1 copy Front cover (3/4MW4U)
MS2665C-01 MS2665C-02 MS2665C-04 MS2665C-06 MS2665C-07	Options Reference crystal oscillator Narrow resolution bandwidth High-speed time domain sweep Trigger/gate circuit AM/FM demodulator (outputs to loudspeaker or earphone connector)
MS2665C-10	Centronics interface (GPIB interface cannot be installed simultaneously)
MS2665C-15	Sweep signal output
J0561 J0104A CSCJ-256K-SM CSCJ-512K-SM CSCJ-001M-SM CSCJ-002M-SM B0395A B0395B B0391A B0391B MP612A MP613A J0805	Application parts Coaxial cord (N-P-5W · 5D-2W · N-P-5W), 1 m Coaxial cord (BNC-P · RG-55/U · N-P) , 1 m 256 KB memory card (meets PCMCIA Rel. 2.0) 512 KB memory card (meets PCMCIA Rel. 2.0) 1024 KB memory card (meets PCMCIA Rel. 2.0) 2048 KB memory card (meets PCMCIA Rel. 2.0) Rack mount kit (IEC) Rack mount kit (JIS) Carrying case (hard type, with casters) Carrying case (hard type, without casters) RF Fuse Holder Fuse Element DC block (Model 7003, 10 kHz to 18 GHz, \pm 50 V, Weinschel product, N-type) DC Block Adapter (50 Ω , 9 kHz to 3 GHz, \pm 50 V, N-type) DC Block Adapter (50 Ω , 30 kHz to 2 GHz, \pm 50 V, N-type) DC Block Adapter (75 Ω , 10 kHz to 2.2 GHz, \pm 50 V, NC-type) 50 Ω \rightarrow 75 Ω Impedance Transformer (9 kHz to 3 GHz, \pm 100 V, NC-type) 50 Ω \leftrightarrow 75 Ω Impedance Transformer (10 to 1200 MHz, transformer type, NC-type)
MA2507A	GPIB cable, 1 m
MA8601A	GPIB cable, 2 m
MA8601J	RS-232C cable, 1 m (for PC-98 Personal Computer and VP-600, D-sub 25 pins, straight)
MA1621A	RS-232C cable, 1 m (for PC/AT compatible, D-sub 9-pins, cross)
MP614A	7 GHz band coaxial/waveguide adapter (5.8 to 8.6 GHz, N-J · BRJ-7)
J0007 J0008 J0742A	10 GHz band coaxial/waveguide adapter (8.2 to 12.4 GHz, N-J · BRJ-10)
J0743A	Coaxial adapter (N-P · SMA-J)
J0064A	Coaxial cord, 2 m (N-type connector, general use)
J0064C	Coaxial cord, 2 m (N-type connector, low-loss type)
J0004 DGM010-02000EE DGM024-02000EE	

SPECTRUM ANALYZER
MS2663C
 9 kHz to 8.1 GHz

For Measuring up to 3rd Order Spurious of Mobile Communications Band



The MS2663C covers a frequency range of 9 kHz to 8.1 GHz. This allows measurement of spurious frequencies of up to three times greater than the frequency bands used worldwide for mobile communications. The MS2663C has superior basic performance such as high C/N ratio, low distortion, and high frequency/level accuracies and are easy to operate. The MS2663C has a “Measure” function for

evaluation of radio equipment (frequency counter, C/N, adjacent channel power, occupied frequency bandwidth, burst average power, and template decision function), and enables the Two-screen display and FM demodulation waveform display. The large selection of options means that a wider range of applications can be handled at reasonable cost.

Specifications

Except where noted otherwise, specified values are obtained after warming up the equipment for 30 minutes at a constant ambient temperature and then performing calibration. The typical values are given for reference and are not guaranteed.

Frequency	Frequency range	9 kHz to 8.1 GHz
	Frequency band	Band 0 (0 to 3.2 GHz); Band 1 – (2.92 to 6.5 GHz); Band 1 + (6.4 to 8.1 GHz)
	Pre-selector range	2.92 to 8.1 GHz (band 1–, 1+)
	Display frequency accuracy	± (display frequency x reference frequency accuracy + span x span accuracy + 100 Hz) *Span: ≥10 kHz, after calibration
	Marker frequency display accuracy	Normal: Same as display frequency accuracy; Delta: Same as frequency span accuracy
	Frequency counter	Resolution: 1 Hz, 10 Hz, 100 Hz, 1 kHz Accuracy: Display frequency x reference frequency accuracy ±1 LSD (at S/N: ≥20 dB)
	Frequency span	Setting range: 0 Hz, 1 kHz to 8.2 GHz Accuracy: ±2.5% (span: ≥10 kHz), ±5% (span: <10 kHz, Option 02 installed)
	Resolution bandwidth (RBW) (3 dB bandwidth)	Setting range: 1 kHz, 3 kHz, 10 kHz, 30 kHz, 100 kHz, 300 kHz, 1 MHz, 3 MHz (manually settable, or automatically settable according to frequency span) *Option 02: 30 Hz, 100 Hz, and 300 Hz are added. Measurements of noise, C/N, adjacent channel power, and channel power by measure function are executed with the calculated equivalent noise bandwidth of the RBW. Bandwidth accuracy: ±20% (1 kHz to 1 MHz), ±30% (3 MHz) Selectivity (60 dB : 3 dB): ≤15 : 1
	Video bandwidth (VBW)	1 Hz to 3 MHz (1-3 sequence), OFF *Manually settable, or automatically settable according to RBW
	Noise sideband, stability	Noise sidebands: ≤-100 dBc/Hz (1 GHz, 10 kHz offset) Residual FM: ≤20 Hzp-p/0.1 s (1 GHz, span: 0 Hz) Frequency drift: ≤200 Hz/min (span: ≤10 kHz, sweep time: ≤100 s) *After 1 hour warm-up at constant ambient temperature
Reference oscillator	Frequency: 10 MHz Aging rate: 2 x 10 ⁻⁶ /year (typical); Option 01: 1 x 10 ⁻⁷ /year, 2 x 10 ⁻⁸ /day Temperature characteristics: 1 x 10 ⁻⁵ (typical, 0° to 50°C); Option 01: ±5 x 10 ⁻⁸ (0° to 50°C) *Referenced to frequency at 25°C	

Continued on next page

Amplitude	Level measurement	Measurement range: Average noise level to +30 dBm Maximum input level: +30 dBm (CW average power, RF ATT: ≥10 dB), ±0 Vdc Average noise level: [Without Option 08] ≤-115 dBm (1 MHz to 1 GHz, band 0), ≤-115 dBm + 1.5f [GHz] dB (1 to 3.1 GHz, band 0), ≤-115 dBm + 0.5f [GHz] dB (2.92 to 8.1 GHz, band 1) *RBW: 1 kHz, VBW: 1 Hz, RF ATT: 0 dB [With Option 08, pre-amplifier: off] ≤114 dBm (1 MHz to 1 GHz, Band 0), ≤-114 dBm + 1.5 x f [GHz] dB (1 to 3.1 GHz, Band 0), -115 dBm + 0.5 x f [GHz] dB (2.92 to 8.1 GHz, Band 1) Residual response: ≤-100 dBm (RF ATT: 0 dB, input: 50 Ω termination, 1 MHz to 8.1 GHz)	
	Total level accuracy	±1.3 dB (100 kHz to 3.1 GHz band 0), ±2.3 dB (2.92 to 8.1 GHz, band 1) *Level measurement accuracy after calibration using internal calibration signal Total level accuracy: Reference level accuracy (0 to -49.9 dBm) + frequency response + log linearity (0 to -20 dB) + calibrated signal source accuracy	
	Reference level	Setting range Log scale: -100 to +30 dBm; Linear scale: 224 μV to 7.07 V Unit Log scale: dBm, dBμV, dBmV, V, dBμVemf, W, dBμV/m Linear scale: V Reference level accuracy: ±0.4 dB (-49.9 to 0 dBm), ±0.75 dB (-69.9 to -50 dBm, 0.1 to +30 dBm), ±1.5 dB (-80 to -70 dBm) *After calibration, at 100 MHz, span: 1 MHz (when RF ATT, RBW, VBW and sweep time set to AUTO) RBW switching uncertainty: ±0.3 dB (1 kHz to 1 MHz), ±0.4 dB (3 MHz) *After calibration, referenced to RBW: 3 kHz Input attenuator (RF ATT) Setting range: 0 to 70 dB (10 dB steps) *Manually settable, or automatically settable according to reference level Accuracy: ±0.3 dB (0 to 50 dB), ±1.0 dB (0 to 70 dB) *After calibration, frequency: 100 MHz, referenced to RF ATT: 10 dB	
	Frequency response	±0.5 dB (100 kHz to 3.2 GHz, band 0, referenced to 100 MHz, RF ATT: 10 dB, 18° to 28°C) ±1.5 dB (9 to 100 kHz, band 0, referenced to 100 MHz, RF ATT: 10 dB, 18° to 28°C) ±1.5 dB (2.92 to 8.1 GHz, band 1, referenced to 100 MHz, RF ATT: 10 dB, 18° to 28°C) ±1.0 dB (100 kHz to 3.2 GHz, band 0, RF ATT: 10 to 50 dB) ±3.0 dB (2.92 to 8.1 GHz, band 1, RF ATT: 10 to 50 dB) *At band 1, after pre-selector tuning	
	Waveform display	Scale (10 div) Log scale: 10, 5, 2, 1 dB/div Linear scale: 10, 5, 2, 1%/div Linearity (after calibration) Log scale: ±0.4 dB (0 to -20 dB, RBW: ≤1 MHz), ±1.0 dB (0 to -70 dB, RBW: ≤100 kHz), ±1.5 dB (0 to -85 dB, RBW: ≤3 kHz), ±2.5 dB (0 to -90 dB, RBW: ≤3 kHz) Linear scale: ±4% (compared to reference level) Marker level resolution Log scale: 0.01 dB, Linear scale: 0.02% of reference level	
	Spurious response	2nd harmonic distortion: ≤-60 dBc (10 to 200 MHz, band 0, mixer input: -30 dBm), ≤-75 dBc (0.2 to 1.3 GHz, band 0, mixer input: -30 dBm), ≤-70 dBc (1.3 to 1.55 GHz, band 0, mixer input: -30 dBm), ≤-80 dBc (0.8 to 1 GHz, band 0, mixer input: -30 dBm), ≤-100 dBc (1.46 to 4.05 GHz, band 1, mixer input: -20 dBm) Two signals 3rd order intermodulation distortion: ≤-70 dBc (10 to 100 MHz), ≤-80 dBc (0.1 to 8.1 GHz) *Frequency difference of two signals: ≥50 kHz, mixer input: -30 dBm Image response: ≤-70 dBc, Multiple response: ≤-70 dBc (band 1)	
	1 dB gain compression	≥-5 dBm (≥100 MHz, at mixer input level)	
	Maximum dynamic range	1 dB gain compression level to average noise level: >110 dB (0.1 to 1 GHz, band 0), >110 dB - 1.5f [GHz] dB (1 to 3.1 GHz, band 0), >110 dB - 0.5f [GHz] dB (2.92 to 8.1 GHz, band 1) Distortion characteristics (RBW: 1 kHz) 2nd harmonic: >72.5 dB (10 to 200 MHz), >80 dB (200 to 500 MHz), >80 - 0.75f [GHz] dB (0.5 to 1.3 GHz), >82.5 - 0.75f [GHz] dB (0.8 to 1 GHz), >77.5 - 0.75f [GHz] dB (1.3 to 1.55 GHz, band 0), >97.5 - 0.25f [GHz] dB (1.46 to 4.05 GHz, band 1) 3rd order intermodulation: >80 dB (10 to 100 MHz), >83.3 dB (0.1 to 1 GHz), >83.3 - f [GHz] dB (1 to 3.1 GHz, band 0), >83.3 - (1/3)f [GHz] dB (2.92 to 8.1 GHz, band 1)	
	Sweep	Sweep time	Setting range : 20 ms to 1000 s (manually settable, or automatically settable according to span, RBW, and VBW) Accuracy: ±15% (20 ms to 100 s), ±45% (110 to 1000 s), ±1% (time domain sweep: digital zero span mode)
		Sweep mode	Continuous, single
Time domain sweep mode		Analog zero span, digital zero span	
Zone sweep		Sweep only in frequency range indicated by zone marker	
Tracking sweep		Sweeps while tracing peak points within zone marker (zone sweep also possible)	
Functions	Number of data points	501	
	Detection mode	NORMAL: Simultaneously displays max. and min. points between sample points POS PEAK: Displays max. point between sample points NEG PEAK: Displays min. point between sample points SAMPLE: Displays momentary value at sample points Detection mode switching uncertainty: ±0.5 dB (at reference level)	
	Display	Color TFT-LCD, Size: 5.5 inch; Number of colors: 17 (RGB, each 64-scale settable); Intensity adjustment: 5 steps settable	

Continued on next page

Functions	Display functions	Trace A: Displays frequency spectrum Trace B: Displays frequency spectrum Trace Time: Displays time domain waveform at center frequency Trace A/B: Displays Trace A and Trace B simultaneously. Simultaneous sweep of same frequency, alternate sweep of independent frequencies Trace A/BG: Displays frequency region to be observed (background) and object band (foreground) selected from background with zone marker simultaneously, alternate sweep Trace A/Time: Displays frequency spectrum, and time domain waveform at center frequency simultaneously, alternate sweep Trace move/calculation: A → B, B → A, A ↔ B, A + B → A, A - B → A, A - B + DL → A
	Storage functions	NORMAL, VIEW, MAX HOLD, MIN HOLD, AVERAGE, CUMULATIVE, OVER WRITE
	FM demodulation waveform display function	Demodulation range: 2, 5, 10, 20, 50, 100, 200 kHz/div Marker display Accuracy: ±5% of full scale (referenced to center frequency, DC-coupled. RBW: 3 MHz, VBW: 1 Hz, CW) Demodulation frequency range: DC (50 Hz at AC-coupled) to 100 kHz (range: ≤20 kHz/div, VBW: off, at 3 dB bandwidth) DC (50 Hz at AC-coupled) to 500 kHz (range: ≥50 kHz/div, VBW: off, at 3 dB bandwidth) *RBW: >1 kHz usable
	Input connector	N-J, 50 Ω
	Auxiliary signal input and output	IF OUTPUT: 10.69 MHz, BNC connector VIDEO OUTPUT (Y): 0 to 0.5 V ±0.1 V (100 MHz, from lower edge to upper edge at 10 dB/div or 10%/div, 75 Ω terminated), BNC connector COMPOSITE OUTPUT: For NTSC, 1 Vp-p (75 Ω terminated), BNC connector EXT REF INPUT: 10 MHz ±10 Hz, ≥0 dBm (50 Ω terminated), BNC connector
	Signal search	AUTO TUNE, PEAK → CF, PEAK → REF, SCROLL
	Zone marker	NORMAL, DELTA
	Marker →	MARKER → CF, MARKER → REF, MARKER → CF STEP SIZE, ΔMARKER → SPAN, ZONE → SPAN
	Peak search	PEAK, NEXT PEAK, NEXT RIGHT PEAK, NEXT LEFT PEAK, MIN DIP, NEXT DIP
	Multimarker	Number of markers: 10 max. (HIGHEST 10, HARMONICS, MANUAL SET)
	Measure	Noise power (dBm/Hz, dBm/ch), C/N (dBc/Hz, dBc/ch), occupied bandwidth (power N% method, X-dB down method), adjacent channel power (REF: total power/reference level/in-band level method, channel designate display: 2 channels x graphic display), average power of burst signal (average power in designated time range of time domain waveform), channel power (dBm, dBm/Hz), template comparison (upper/lower limits x each 2, time domain), MASK (upper/lower x each 2, frequency domain)
	Save/recall	Saves and recalls setting conditions and waveform data to internal memory (max. 12) or memory card
	Hard copy	Printer (HP dotmatrix, EPSON dotmatrix compatible models): Display data can be hard-copied via RS-232C, GPIB, and Centronics (Option 10) interface Plotter (HP-GL, GP-GL compatible models): Display data can be output via RS-232C and GPIB interface
	PTA	Language: PTL (interpreter based on BASIC) Programming: Using external computer Program memory: Memory card, upload/download to/from external computer Programming capacity: 192 KB Data processing: Directly accesses measurement data according to system variables, system subroutines, and system functions
	RS-232C	Outputs data to printer and plotter. Control from external computer (excluding power switch)
	GPIB	Meets IEEE488.2. Controlled by external computer (excluding power switch). Or controls external equipment with PTA Interface function: SH1, AH1, T6, L4, SR1, RL1, PP0, DC1, DT1, C1, C2, C3, C4, C28
Correction	Automatic correction of insertion loss of MA1621A Impedance Transformer Correction accuracy (RF ATT: ≥10 dB): ±2.5 dB (9 to 100 kHz), ±1.5 dB (100 kHz to 2 GHz), ±2.0 dB (2 to 3 GHz, typical) Antenna correction coefficients: Correct display and measurement of field strengths (dBμV/m) for specified antennas, Internal antenna correction coefficients (MP534A/651A Dipole Antenna, MP635A/666A Log-Periodic Antenna, MP414B Loop Antenna, and four antennas user-defined; writes via GPIB or RS-232C, saves/loads to/from memory card)	
Memory card interface	Functions: Saving/recalling measurement parameters/waveform data, uploading/downloading PTA programs; Applicable cards: SRAM, EPROM, Flash EPROM *Only SRAM writable; Card capacity: 2 MB max. Connector: Meets the PCMCIA Rel. 2.0, 2 slots	
Others	EMC	EN61326: 1997/A1, 1998 (Class A) EN61000-3-2: 1995/A2, 1998 (Class A) EN61326: 1997/A1, 1998 (Annex A)
	LVD	EN610101-1: 1993/A2, 1995 (Installation Category II, Pollution degree 2)
	Vibration	Meets the MIL-STD-810D
	Power (operating range)	85 to 132/170 to 250 Vac (automatic voltage switching), 47.5 to 63 Hz, 380 to 420 Hz (85 to 132 V only), ≤330 VA
	Dimensions and mass	320 (W) x 177 (H) x 351 (D) mm, ≤13.5 kg (without option)
Ambient temperature	0° to 50°C (operate), -40° to +75°C (storage)	

• Option 01: Reference crystal oscillator

Frequency	10 MHz
Aging rate	≤1 x 10 ⁻⁷ /year, ≤2 x 10 ⁻⁸ /day (after power on, with reference to frequency after 24 h)
Temperature characteristics	±5 x 10 ⁻⁸ (0° to 50°C, with reference to 25°C)
Buffer output	10 MHz, >2 Vp-p (200 Ω termination), BNC connector

• Option 02: Narrow resolution bandwidth

Resolution bandwidth (3 dB)	30 Hz, 100 Hz, 300 Hz
Resolution bandwidth switching uncertainty	±0.4 dB (RBW 3 kHz referenced)
Resolution bandwidth accuracy	±20% (100, 300 Hz)
Selectivity (60 dB:3 dB)	≤15 : 1 (RBW: 100, 300 Hz), ≤20 : 1 (RBW: 30 Hz)

• **Option 04: High-speed time domain sweep**

Sweep time	12.5 μ s, 25 μ s, 50 μ s, 100 to 900 μ s (one most significant digit settable) 1.0 to 19 ms (two upper significant digits settable)
Accuracy	\pm 1%
Marker level resolution	0.1 dB (log scale), 0.2% (linear scale, relative to reference level)

• **Option 07: AM/FM demodulator**

Voice output	With internal loudspeaker and earphone connector (\varnothing 3.5 jack), adjustable volume
--------------	---

• **Option 10: Centronics interface*1**

Function	Outputs data to printer (Centronics standard)
Connector	D-sub 25-pin (jack)

*1: GPIB interface cannot be installed simultaneously.

• **Option 06: Trigger/gate circuit**

Trigger switch	FREERUN, TRIGGERED	
Trigger source	EXT	Trigger level: \pm 10 V (resolution: 0.1 V), TTL level Trigger slope: Rise/Fall Connector: BNC
	VIDEO	Log scale: -100 to 0 dB (resolution: 1 dB) Trigger slope: Rise/Fall
	WIDE IF VIDEO	Trigger level: High, middle, or low selectable Bandwidth: \geq 20 MHz Trigger slope: Rise/Fall
	LINE	Frequency: 47.5 to 63 Hz (line lock)
	TV	Method: M-NTSC, B/G/H PAL Sync: V-SYNC, H-SYNC Sync line (NTSC) H-SYNC (ODD): 7 to 262 line, H-SYNC (EVEN): 1 to 263 line Sync line (PAL) H-SYNC (ODD): 1 to 312 line, H-SYNC (EVEN): 317 to 625 line *Option 16 required
Trigger delay	Pre-trigger (displays waveform from previous max. 1 screen at trigger occurrence point) Range: $-$ time span to 0 s Resolution: time span/500 Post trigger (displays waveform from after max. 65.5 ms at trigger occurrence point) Range: 0 to 65.5 ms Resolution: 1 ms	
Gate sweep	In frequency domain, displays spectrum of input signal in specified gate interval Gate delay: 0 to 65.5 ms (from trigger point, resolution: 1 μ s) Gate width: 2 μ s to 65.5 ms (from gate delay, resolution: 1 μ s)	

• **Option 08: Pre-amplifier*1,*2**

Frequency range	100 kHz to 3 GHz	
Noise figure	\leq 8 dB (typical, $<$ 2 GHz), \leq 13 dB (typical, \geq 2 GHz)	
Amplitude	Measurement range	Average noise level to +10 dBm
	Max. input level	CW average power: +10 dBm, \pm 0 Vdc
	Average noise level	\leq -132 dBm (1 MHz to 1 GHz), \leq -132 dBm + 2f [GHz] dB ($>$ 1 GHz) *RBW: 1 kHz, VBW: 1 Hz, RF ATT: 0 dB
	Reference level	Setting range Log scale: -120 to +10 dBm, or equivalent level Linear scale: 22.4 μ V to 707 mV Reference level accuracy: \pm 0.5 dB (-69.9 to -20 dBm), \pm 0.75 dB (-89.9 to -70 dBm, -19.9 to +10 dBm) *After calibration, referenced to 100 MHz, 1 MHz span (RF ATT, RBW, VBW and sweep time set to AUTO) RBW switching uncertainty: \pm 0.5 dB *After calibration, referenced to 3 kHz RBW RF ATT switching uncertainty: \pm 0.5 dB (0 to 50 dB), \pm 1.0 dB (0 to 70 dB) *After calibration, referenced to 100 MHz, RF ATT: 10 dB
	Frequency response	\pm 2.0 dB (100 kHz to 3 GHz, referenced to 100 MHz, RF ATT: 10 to 50 dB)
	Linearity of waveform display	Log scale (after calibration): \pm 0.5 dB (0 to -20 dB), \pm 1.0 dB (0 to -60 dB), \pm 1.5 dB (0 to -75 dB) Linear scale (after calibration): \pm 5% (according to reference level)
	Spurious response	Two signals 3rd order intermodulation distortion: \leq -70 dBc (10 MHz to 3 GHz) *Frequency difference of two signals: \geq 50 kHz, Pre-amplifier input*2: -55 dBm
	1 dB gain compression	\geq -35 dBm (\geq 100 MHz, at pre-amplifier input level*3)

*1: Overall specification with pre-amplifier on (Noise figure is the simple performance)

*2: Option 20 cannot be installed simultaneously

*3: Pre-amplifier input level = RF input level – RF ATT setting level

• Option 12: QP detector

Functions	QP detection *Requires Option 02.																																											
6 dB bandwidth	200 Hz, 9 kHz, 120 kHz Accuracy: $\pm 30\%$ (18° to 28°C)																																											
Display	LOG scale, 5 dB/div (10 divisions) Linearity: $\leq \pm 2.0$ dB (0 to -40 dB, CW signal, reference level: 60 dB μ V, RF ATT: 0 dB, 18° to 28°C)																																											
Pulse response characteristics	Response to CISPR pulse (DET mode: QP, 18° to 28°C)																																											
	<table border="1"> <thead> <tr> <th rowspan="2">Repetition frequency</th> <th colspan="3">Bandwidth</th> </tr> <tr> <th>120 kHz</th> <th>9 kHz</th> <th>200 Hz</th> </tr> </thead> <tbody> <tr> <td>1 kHz</td> <td>$\leq -8.0 \pm 1.0$ dB</td> <td>$\leq -4.5 \pm 1.0$ dB</td> <td>-</td> </tr> <tr> <td>100 Hz</td> <td>Referenced</td> <td>Referenced</td> <td>$\leq -4.0 \pm 1.0$ dB</td> </tr> <tr> <td>60 Hz</td> <td>-</td> <td>-</td> <td>$\leq -3.0 \pm 1.0$ dB</td> </tr> <tr> <td>25 Hz</td> <td>-</td> <td>-</td> <td>Referenced</td> </tr> <tr> <td>20 Hz</td> <td>$\leq +9.0 \pm 1.0$ dB</td> <td>$\leq +6.5 \pm 1.0$ dB</td> <td>-</td> </tr> <tr> <td>10 Hz</td> <td>$\leq +14.0 \pm 1.5$ dB</td> <td>$\leq +10.0 \pm 1.5$ dB</td> <td>$\leq +4.0 \pm 1.0$ dB</td> </tr> <tr> <td>5 Hz</td> <td>-</td> <td>-</td> <td>$\leq +7.5 \pm 1.5$ dB</td> </tr> <tr> <td>2 Hz</td> <td>$\leq +26.0 \pm 2.0$ dB</td> <td>$\leq +20.5 \pm 2.0$ dB</td> <td>$\leq +13.0 \pm 2.0$ dB</td> </tr> <tr> <td>1 Hz</td> <td>$\leq +28.5 \pm 2.0$ dB</td> <td>$\leq +22.5 \pm 2.0$ dB</td> <td>$\leq +17.0 \pm 2.0$ dB</td> </tr> </tbody> </table>	Repetition frequency	Bandwidth			120 kHz	9 kHz	200 Hz	1 kHz	$\leq -8.0 \pm 1.0$ dB	$\leq -4.5 \pm 1.0$ dB	-	100 Hz	Referenced	Referenced	$\leq -4.0 \pm 1.0$ dB	60 Hz	-	-	$\leq -3.0 \pm 1.0$ dB	25 Hz	-	-	Referenced	20 Hz	$\leq +9.0 \pm 1.0$ dB	$\leq +6.5 \pm 1.0$ dB	-	10 Hz	$\leq +14.0 \pm 1.5$ dB	$\leq +10.0 \pm 1.5$ dB	$\leq +4.0 \pm 1.0$ dB	5 Hz	-	-	$\leq +7.5 \pm 1.5$ dB	2 Hz	$\leq +26.0 \pm 2.0$ dB	$\leq +20.5 \pm 2.0$ dB	$\leq +13.0 \pm 2.0$ dB	1 Hz	$\leq +28.5 \pm 2.0$ dB	$\leq +22.5 \pm 2.0$ dB	$\leq +17.0 \pm 2.0$ dB
	Repetition frequency		Bandwidth																																									
		120 kHz	9 kHz	200 Hz																																								
	1 kHz	$\leq -8.0 \pm 1.0$ dB	$\leq -4.5 \pm 1.0$ dB	-																																								
	100 Hz	Referenced	Referenced	$\leq -4.0 \pm 1.0$ dB																																								
	60 Hz	-	-	$\leq -3.0 \pm 1.0$ dB																																								
	25 Hz	-	-	Referenced																																								
	20 Hz	$\leq +9.0 \pm 1.0$ dB	$\leq +6.5 \pm 1.0$ dB	-																																								
	10 Hz	$\leq +14.0 \pm 1.5$ dB	$\leq +10.0 \pm 1.5$ dB	$\leq +4.0 \pm 1.0$ dB																																								
5 Hz	-	-	$\leq +7.5 \pm 1.5$ dB																																									
2 Hz	$\leq +26.0 \pm 2.0$ dB	$\leq +20.5 \pm 2.0$ dB	$\leq +13.0 \pm 2.0$ dB																																									
1 Hz	$\leq +28.5 \pm 2.0$ dB	$\leq +22.5 \pm 2.0$ dB	$\leq +17.0 \pm 2.0$ dB																																									
QP on/off switching uncertainty (PEAK, QP)	$\leq \pm 1.0$ dB (CW signal, reference level - 40 dB, after auto-calibration, 18° to 28°C)																																											
Detection mode	QP, AVERAGE																																											
Field strength measurement	Waveform data compensation data display for specified antenna factor, field strength (dB μ V/m) Built-in antenna factors: MP534A/651A Dipole Antenna, MP635A/666A Log-Periodic Antenna, MP414B Loop Antenna, user-defined (four types writable via GPIB or RS-232C, can be saved/loaded to/from memory card)																																											

• Option 14: PTA parallel I/O

Functions	Controls external devices from PTA, cannot be installed when Option 10 installed																																																																														
System variables	As follows using PTA system variables IOA: Controls 8-bit parallel output port A IOB: Controls 8-bit parallel output port B IOC: Controls 4-bit parallel input/output port C IOD: Controls 4-bit parallel input/output port D EIO: Controls I/O switching of ports C/D EXO: Controls I/O trigger																																																																														
PTL statements	External interrupt control of input to I/O ports using PTA-PTL statements IOEN statement: Enables interrupt input IODI statement: Disables interrupt input IOMA statement: Masks interrupt input ON TO GOTO statement: Changes program flow at interrupt generation ON TO GOSUB statement: Changes program flow at interrupt generation																																																																														
Write strobe signal	Write strobe signal (negative pulse) output externally at control of output ports C/D																																																																														
Power supply	External +5 ± 0.5 Vdc (max. 100 mA) supply																																																																														
Signal logic levels	Negative logic, TTL level Specified current: Output ports A/B (max. output current Hi: 2.6 mA, Lo: 24 mA) Output ports C/D (max. output current Hi: 15 mA, Lo: 24 mA) Other control output lines (max. output current Hi: 0.4 mA, Lo: 8 mA)																																																																														
Connection cable connectors	Amphenol 36 pins																																																																														
Connector pin layout	<table border="1"> <thead> <tr> <th>No.</th> <th>Item</th> <th>No.</th> <th>Item</th> <th>No.</th> <th>Item</th> </tr> </thead> <tbody> <tr> <td>1</td> <td>GND</td> <td>13</td> <td>Output port B (0) LSB</td> <td>25</td> <td>I/O port D (0) LSB</td> </tr> <tr> <td>2</td> <td>Trigger input</td> <td>14</td> <td>Output port B (1)</td> <td>26</td> <td>I/O port D (1)</td> </tr> <tr> <td>3</td> <td>Trigger output 1</td> <td>15</td> <td>Output port B (2)</td> <td>27</td> <td>I/O port D (2)</td> </tr> <tr> <td>4</td> <td>Trigger output 2</td> <td>16</td> <td>Output port B (3)</td> <td>28</td> <td>I/O port D (3) MSB</td> </tr> <tr> <td>5</td> <td>Output port A (0) LSB</td> <td>17</td> <td>Output port B (4)</td> <td>29</td> <td>Port C status 0/1: I/O</td> </tr> <tr> <td>6</td> <td>Output port A (1)</td> <td>18</td> <td>Output port B (5)</td> <td>30</td> <td>Port D status 0/1: I/O</td> </tr> <tr> <td>7</td> <td>Output port A (2)</td> <td>19</td> <td>Output port B (6)</td> <td>31</td> <td>Write strobe signal</td> </tr> <tr> <td>8</td> <td>Output port A (3)</td> <td>20</td> <td>Output port B (7) MSB</td> <td>32</td> <td>Interruption signal</td> </tr> <tr> <td>9</td> <td>Output port A (4)</td> <td>21</td> <td>I/O port C (0) LSB</td> <td>33</td> <td>Not used</td> </tr> <tr> <td>10</td> <td>Output port A (5)</td> <td>22</td> <td>I/O port C (1)</td> <td>34</td> <td>+5 V power supply</td> </tr> <tr> <td>11</td> <td>Output port A (6)</td> <td>23</td> <td>I/O port C (2)</td> <td>35</td> <td>Not used</td> </tr> <tr> <td>12</td> <td>Output port A (7) MSB</td> <td>24</td> <td>I/O port C (3) MSB</td> <td>36</td> <td>Not used</td> </tr> </tbody> </table>	No.	Item	No.	Item	No.	Item	1	GND	13	Output port B (0) LSB	25	I/O port D (0) LSB	2	Trigger input	14	Output port B (1)	26	I/O port D (1)	3	Trigger output 1	15	Output port B (2)	27	I/O port D (2)	4	Trigger output 2	16	Output port B (3)	28	I/O port D (3) MSB	5	Output port A (0) LSB	17	Output port B (4)	29	Port C status 0/1: I/O	6	Output port A (1)	18	Output port B (5)	30	Port D status 0/1: I/O	7	Output port A (2)	19	Output port B (6)	31	Write strobe signal	8	Output port A (3)	20	Output port B (7) MSB	32	Interruption signal	9	Output port A (4)	21	I/O port C (0) LSB	33	Not used	10	Output port A (5)	22	I/O port C (1)	34	+5 V power supply	11	Output port A (6)	23	I/O port C (2)	35	Not used	12	Output port A (7) MSB	24	I/O port C (3) MSB	36	Not used
No.	Item	No.	Item	No.	Item																																																																										
1	GND	13	Output port B (0) LSB	25	I/O port D (0) LSB																																																																										
2	Trigger input	14	Output port B (1)	26	I/O port D (1)																																																																										
3	Trigger output 1	15	Output port B (2)	27	I/O port D (2)																																																																										
4	Trigger output 2	16	Output port B (3)	28	I/O port D (3) MSB																																																																										
5	Output port A (0) LSB	17	Output port B (4)	29	Port C status 0/1: I/O																																																																										
6	Output port A (1)	18	Output port B (5)	30	Port D status 0/1: I/O																																																																										
7	Output port A (2)	19	Output port B (6)	31	Write strobe signal																																																																										
8	Output port A (3)	20	Output port B (7) MSB	32	Interruption signal																																																																										
9	Output port A (4)	21	I/O port C (0) LSB	33	Not used																																																																										
10	Output port A (5)	22	I/O port C (1)	34	+5 V power supply																																																																										
11	Output port A (6)	23	I/O port C (2)	35	Not used																																																																										
12	Output port A (7) MSB	24	I/O port C (3) MSB	36	Not used																																																																										

• Option 15: Sweep signal output

Sweep output (X)	0 to 10 V ± 1 V (≥ 100 k Ω termination, from left side to right side of display scale), BNC connector
Sweep status output (Z)	TTL level (low level with sweeping), BNC connector

• Option 20: Tracking generator*1

Frequency range	9 kHz to 3 GHz
Output level range	0 to -60 dBm
Setting resolution	0.1 dB
Output level accuracy	$\leq \pm 1.0$ dB (at 100 MHz, 0 dBm)
Output level flatness	$\leq \pm 1.5$ dB (100 kHz to 3 GHz, output level: 0 dBm, referenced to 100 MHz frequency)
Output level linearity	$\leq \pm 1.0$ dB (0 to -30 dBm), $\leq \pm 2.0$ (-30 to -60 dBm) *100 kHz to 3 GHz, 0 dBm output level reference
Spurious	Harmonic: ≤ -15 dBc (9 to 100 kHz), ≤ -20 dBc (100 kHz to 3 GHz) Non-harmonic: ≤ -15 dBc (9 to 100 kHz), ≤ -35 dBc (100 kHz to 2 GHz), ≤ -30 dBc (2 to 3 GHz)
Tracking generator feed through	≤ -95 dBm (spectrum analyzer input and tracking generator output connectors terminated at 50 Ω)
Output connector	N-J, 50 Ω

*1: Option 08 can not be installed simultaneously.

Ordering information

Please specify model/order number, name, and quantity when ordering.

Model/order No.	Name
MS2663C	Main frame Spectrum Analyzer
	Standard accessories
	Power cord, 2.6 m: 1 pc
F0013	Fuse, 5 A: 2 pcs
W1251AE	MS2650B, MS2660B/C series operation manual: 1 copy
B0329G	Front cover (3/4MW4U)
	Options
MS2663C-01	Reference crystal oscillator
MS2663C-02	Narrow resolution bandwidth
MS2663C-04	High-speed time domain sweep
MS2663C-06	Trigger/gate circuit
MS2663C-07	AM/FM demodulator
MS2663C-08	Pre-amplifier (Option 20 cannot be installed simultaneously)
MS2663C-10	Centronics interface (GPIB cannot be installed simultaneously)
MS2663C-12	QP detector (requires Option 02, QP-BW: 0.2/9/120 kHz)
MS2663C-14	PTA parallel I/O (Option 10 cannot be installed simultaneously)
MS2663C-15	Sweep signal output
MS2663C-20	Tracking generator (Option 08 cannot be installed simultaneously)
MS2663C-21	Television monitor (Multi)
MS2663C-24	Television monitor (Brazil)
	Application parts
MX260002A	CDMA Cellular System Measurement Software
MX260003A	PDC Measurement Software (for base station)
MX260004A	GSM Measurement Software
MX261001A	Low-Power Data Communication System Measurement Software conforming to issue of Direct Spread Spectrum System
MX261002A	Low-Power Data Communication System Measurement Software conforming to issue of Frequency Hopping System
MX262001A	CATV Measurement Software
MX264001A	EMI Measurement Software
J0561	Coaxial cord (N-P-5W · 5D-2W · N-P-5W), 1 m
J0104A	Coaxial cord (BNC-P · RG-55/U · N-P), 1 m
CSCJ-256K-SM	256 KB memory card (meets PCMCIA Rel. 2.0)
CSCJ-512K-SM	512 KB memory card (meets PCMCIA Rel. 2.0)
CSCJ-001M-SM	1024 KB memory card (meets PCMCIA Rel. 2.0)
CSCJ-002M-SM	2048 KB memory card (meets PCMCIA Rel. 2.0)
B0395A	Rack mount kit (IEC)
B0395B	Rack mount kit (JIS)
J0055	Coaxial adapter (NC-P · BNC-J)

• Option 21: Television monitor (Multi)*1

Video	M-NTSC, B/G/H/I/D PAL, color
Audio	Simultaneous monitoring of video and audio *Needs Option 07
Functions	Channel: Automatic setting to broadcast wave of CCIR, Japan, USA, Italy, UK and China; automatic setting to CATV of CCIR, Japan and USA Trigger: Triggered sweep by V-SYNC, H-SYNC *Needs trigger/gate circuit (Option 06) Aux. output: Composite video signal, Connector: BNC

*1: Requires Option 08

• Option 24: Television monitor (Brazil)*1

Video	M-NTSC, M PAL, color
Audio	Simultaneous monitoring of video and audio *Needs Option 07
Functions	Channel: Automatic setting to broadcast wave of CCIR, Japan and USA; automatic setting to CATV of CCIR, Japan and USA Trigger: Triggered sweep by V-SYNC, H-SYNC *Needs trigger/gate circuit (Option 06) Aux. output: Composite video signal, Connector: BNC

*1: Requires Option 08

Model/order No.	Name
J0076	Coaxial adapter (NC-P · F-J)
B0391A	Carrying case (hard type, with casters)
B0391B	Carrying case (hard type, without casters)
MP612A	RF Fuse Holder
MP613A	Fuse Element
J0805	DC Block (MODEL 7003, 10 kHz to 18 GHz, ± 50 V, Weinschel product)
MA2507A	DC Block Adapter (50 Ω , 9 kHz to 3 GHz, ± 50 V)
MA8601A	DC Block Adapter (50 Ω , 30 kHz to 2 GHz, ± 50 V)
MA8601J	DC Block Adapter (75 Ω , 10 kHz to 2.2 GHz, ± 50 V)
MA1621A	50 Ω \rightarrow 75 Ω Impedance Transformer (9 kHz to 3 GHz, ± 100 V)
MP614A	50 Ω \leftrightarrow 75 Ω Impedance Transformer
J0121	Coaxial cord (NC-P-3W · 3C-2WS · NC-P-3W), 1 m
J0308	Coaxial cord (BNC-P · 3C-2WS · NC-P-3W), 1 m
J0063	Fixed attenuator for high power (30 dB, 10 W, DC to 12.4 GHz)
J0395	Fixed attenuator for high power (30 dB, 30 W, DC to 9 GHz)
MP640A	Branch
MP654A	Branch
MP520A	CM Directional Coupler
MP520B	CM Directional Coupler
MP520C	CM Directional Coupler
MP520D	CM Directional Coupler
MP526A	High Pass Filter
MP526B	High Pass Filter
MP526C	High Pass Filter
MP526D	High Pass Filter
MP526G	High Pass Filter
MA1601A	High Pass Filter (800/900 MHz band, N)
J0007	GPIB cable, 1 m
J0008	GPIB cable, 2 m
J0742A	RS-232C cable, 1 m [for PC-98 Personal Computer and VP-600, D-sub 25 pins (straight)]
J0743A	RS-232C cable, 1 m [for AT compatible, D-sub 9-pins (cross)]
MH648A	Pre-Amplifier
MP534A	Dipole Antenna
MP651A	Dipole Antenna
BBA9106/VHA9103	Biconical Antenna
MP635A	Log-Periodic Antenna
MP666A	Log-Periodic Antenna
MB9A	Tripod
MB19A	Tripod
MA2601B	EMI Probe
MA2601C	EMI Probe
KT-10	EMI Clamp
KT-20	EMI Clamp

SPECTRUM ANALYZER
MS2661C
 9 kHz to 3 GHz

For Analyzing Digital Radio Equipment and CATV Signals



The MS2661C Portable Spectrum Analyzer is for signal analysis of radio and other equipment related to improving frequency usage efficiency, higher modulation, and digitalization. This is a synthesized spectrum analyzer covering a wide frequency range from 9 kHz to 3 GHz. It has superior basic performance such as high C/N ratio, low distortion, and high frequency/level accuracies and is easy to operate.

It has a "Measure" function for evaluation of radio equipment (frequency counter, C/N, adjacent channel power, occupied frequency bandwidth, burst average power, and template decision function), and which enables the two-screen display and FM demodulation waveform display. The large selection of options means that a wider range of applications can be handled at reasonable cost.

Specifications

Except where noted otherwise, specified values are obtained after warming up the equipment for 30 minutes at a constant ambient temperature and then performing calibration. The typical values are given for reference and are not guaranteed.

Frequency	Frequency range	9 kHz to 3 GHz
	Display frequency accuracy	\pm (display frequency x reference frequency accuracy + span x span accuracy + 100 Hz) *Span: ≥ 10 kHz, after calibration
	Marker frequency display accuracy	Normal: Same as display frequency accuracy; Delta: Same as frequency span accuracy
	Frequency counter	Resolution: 1 Hz, 10 Hz, 100 Hz, 1 kHz Accuracy: Display frequency x reference frequency accuracy ± 1 LSD (at S/N: ≥ 20 dB)
	Frequency span	Setting range: 0 Hz, 1 kHz to 3.1 GHz Accuracy: $\pm 2.5\%$ (span: ≥ 10 kHz), $\pm 5\%$ (span: < 10 kHz, with option 02)
	Resolution bandwidth (RBW) (3 dB bandwidth)	Setting range: 1 kHz, 3 kHz, 10 kHz, 30 kHz, 100 kHz, 300 kHz, 1 MHz, 3 MHz (manually settable, or automatically settable according to frequency span) *Option 02 : 30 Hz, 100 Hz, and 300 Hz are added. Measurements of noise, C/N, adjacent channel power and channel power by measure function are executed with the calculated equivalent noise bandwidth of the RBW. Bandwidth accuracy: $\pm 20\%$ (1 kHz to 1 MHz), $\pm 30\%$ (3 MHz) Selectivity (60 dB : 3 dB): $\leq 15:1$
	Video bandwidth (VBW)	1 Hz to 3 MHz (1-3 sequence), OFF (manually settable, or automatically settable according to RBW)
	Noise sideband, stability	Noise sideband: ≤ -100 dBc/Hz (1 GHz, 10 kHz offset) Residual FM: ≤ 20 Hzp-p/0.1 s (1 GHz, span: 0 Hz) Frequency drift: ≤ 200 Hz/min (span: ≤ 10 kHz, sweep time: ≤ 100 s) *After 1-hour warm-up at constant ambient temperature
	Reference oscillator	Frequency: 10 MHz Aging rate: 2×10^{-6} /year (typical); Option 01: 1×10^{-7} /year, 2×10^{-8} /day Temperature characteristics: 1×10^{-5} (typical, 0° to 50°C); Option 01: $\pm 5 \times 10^{-8}$ (0° to 50°C) *Referenced to frequency at 25°C
Amplitude	Level measurement	Measurement range: Average noise level to +30 dBm Maximum input level: +30 dBm (CW average power, RF ATT: ≥ 10 dB), ± 50 Vdc Average noise level: ≤ -115 dBm (1 MHz to 1 GHz), ≤ -115 dBm + f [GHz] dB (> 1 GHz), ≤ -114 dBm (1 MHz to 1 GHz, at Option 08 pre-amplifier installed), ≤ -114 dBm + 1.5f [GHz] dB (> 1 GHz, at Option 08 pre-amplifier installed) *RBW: 1 kHz, VBW: 1 Hz, RF ATT: 0 dB Residual response: ≤ -100 dBm (RF ATT: 0 dB, input: 50 Ω termination, 1 MHz to 3 GHz)
	Total level accuracy	± 1.3 dB (100 kHz to 3 GHz) *Level measurement accuracy after calibration using internal calibration signal Total level accuracy: Reference level accuracy (0 to -49.9 dBm) + frequency response + log linearity (0 to -20 dB) + calibration signal source accuracy

Continued on next page

Amplitude	Reference level	<p>Setting range Log scale: -100 to +30 dBm; Linear scale: 224 μV to 7.07 V</p> <p>Unit Log scale: dBm, dBμV, dBmV, V, dBμVemf, W, dBμV/m Linear scale: V</p> <p>Reference level accuracy: ± 0.4 dB (-49.9 to 0 dBm), ± 0.75 dB (-69.9 to -50 dBm, 0.1 to +30 dBm), ± 1.5 dB (-80 to -70 dBm) *After calibration, at 100 MHz, span: 1 MHz (when RF ATT, RBW, VBW, and sweep time set to AUTO) RBW switching uncertainty: ± 0.3 dB (1 kHz to 1 MHz), ± 0.4 dB (3 MHz) *After calibration, referenced to RBW: 3 kHz Input attenuator (RF ATT) Setting range: 0 to 70 dB (10 dB steps) *Manually settable, or automatically settable according to reference level Switching uncertainty: ± 0.3 dB (0 to 50 dB), ± 1.0 dB (0 to 70 dB) *After calibration, frequency: 100 MHz, referenced to RF ATT: 10 dB</p>
	Frequency response	<p>± 0.5 dB (100 kHz to 3 GHz, referenced to 100 MHz, RF ATT: 10 dB, 18° to 28°C) ± 1.5 dB (9 to 100 kHz, referenced to 100 MHz, RF ATT: 10 dB, 18° to 28°C) ± 1.0 dB (100 kHz to 3 GHz, referenced to 100 MHz, RF ATT: 10 to 50 dB)</p>
	Waveform display	<p>Scale (10 div) Log scale: 10, 5, 2, 1 dB/div Linear scale: 10, 5, 2, 1%/div Linearity (after calibration) Log scale: ± 0.4 dB (0 to -20 dB), ± 1.0 dB (0 to -70 dB), ± 1.5 dB (0 to -85 dB), ± 2.5 dB (0 to -90 dB) Linear scale: $\pm 4\%$ (compared to reference level) Marker level resolution Log scale: 0.01 dB; Linear scale: 0.02% of reference level</p>
	Spurious response	<p>2nd harmonic distortion: ≤ -60 dBc (10 to 200 MHz), ≤ -75 dBc (0.2 to 1.5 GHz), ≤ -80 dBc (0.8 to 1 GHz) *Mixer input: -30 dBm Two signals 3rd order intermodulation distortion: ≤ -70 dBc (10 to 100 MHz), ≤ -80 dBc (0.1 to 3 GHz) *Frequency difference of two signals: ≥ 50 kHz, mixer input: -30 dBm</p>
	1 dB gain compression	≥ -5 dBm (≥ 100 MHz, at mixer input level)
Sweep	Maximum dynamic range	<p>1 dB gain compression level to average noise level: > 110 dB (0.1 to 1 GHz), > 110 dB - f [GHz] dB (> 1 GHz), > 109 dB (0.1 to 1 GHz, at Option 08 pre-amplifier installed), > 109 dB - 1.5f [GHz] (> 1 GHz, at Option 08 pre-amplifier installed) Distortion characteristics (RBW: 1 kHz) 2nd harmonic: > 72.5 dB (10 to 200 MHz), > 80 dB (200 to 500 MHz), > 80 - f [GHz] dB (0.5 to 1.5 GHz), > 82.5 - f [GHz] dB (0.8 to 1 GHz) 3rd order intermodulation: > 80 dB (10 to 100 MHz), > 83.3 dB (0.1 to 1 GHz), > 83.3 - (2/3)f [GHz] dB (1 to 3 GHz)</p>
	Sweep time	Setting range : 20 ms to 1000 s (Manually settable, or automatically settable according to span, RBW and VBW) Accuracy: $\pm 15\%$ (20 ms to 100 s), $\pm 45\%$ (110 to 1000 s), $\pm 1\%$ (time domain sweep: digital zero span mode)
	Sweep mode	Continuous, single
	Time domain sweep mode	Analog zero span, digital zero span
	Zone sweep	Sweeps only in frequency range indicated by zone marker
Functions	Tracking sweep	Sweeps while tracing peak points within zone marker (zone sweep also possible)
	Number of data points	501
	Detection mode	<p>NORMAL: Simultaneously displays max. and min. points between sample points POS PEAK: Displays max. point between sample points NEG PEAK: Displays min. point between sample points SAMPLE: Displays momentary value at sample points Detection mode switching uncertainty: ± 0.5 dB (at reference level)</p>
	Display	Color TFT-LCD, Size: 5.5 inch, Number of colors: 17 (RGB, each 64-scale settable); Intensity adjustment: 5 steps settable
	Display functions	<p>Trace A: Displays frequency spectrum Trace B: Displays frequency spectrum Trace Time: Displays time domain waveform at center frequency Trace A/B: Displays Trace A and Trace B simultaneously. Simultaneous sweep of same frequency, alternate sweep of independent frequencies Trace A/BG: Displays frequency region to be observed (background) and object band (foreground) selected from background with zone marker simultaneously at alternate sweep Trace A/Time: Displays frequency spectrum, and time domain waveform at center frequency simultaneously at alternate sweep Trace move/calculation: A \rightarrow B, B \rightarrow A, A \leftrightarrow B, A + B \rightarrow A, A - B \rightarrow A, A - B + DL \rightarrow A</p>
	Storage functions	NORMAL, VIEW, MAX HOLD, MIN HOLD, AVERAGE, CUMULATIVE, OVER WRITE
	FM demodulation waveform display function	<p>Demodulation range: 2, 5, 10, 20, 50, 100, 200 kHz/div Marker display accuracy: $\pm 5\%$ of full scale (referenced to center frequency, DC-coupled, RBW: 3 MHz, VBW: 1 Hz, CW) Demodulation frequency response: DC (50 Hz at AC-coupled) to 100 kHz *Range: ≤ 20 kHz/div, VBW: off, at 3 dB bandwidth DC (50 Hz at AC-coupled) to 500 kHz *Range: ≥ 50 kHz/div, VBW: off, at 3 dB bandwidth *RBW: ≥ 1 kHz usable</p>
	Input connector	N-J, 50 Ω
	Auxiliary signal input and output	<p>IF OUTPUT: 10.69 MHz, BNC connector VIDEO OUTPUT (Y): 0 to 0.5 V ± 0.1 V (100 MHz, from lower edge to upper edge at 10 dB/div or 10%/div, 75 Ω terminated, BNC connector) COMPOSITE OUTPUT: For NTSC, 1 Vp-p (75 Ω terminated), BNC connector EXT REF INPUT: 10 MHz ± 10 Hz, ≥ 0 dBm (50 Ω terminated), BNC connector</p>
	Signal search	AUTO TUNE, PEAK \rightarrow CF, PEAK \rightarrow REF, SCROLL
Zone marker	NORMAL, DELTA	
Marker \rightarrow	MARKER \rightarrow CF, MARKER \rightarrow REF, MARKER \rightarrow CF STEP SIZE, Δ MARKER \rightarrow SPAN, ZONE \rightarrow SPAN	
Peak search	PEAK, NEXT PEAK, NEXT RIGHT PEAK, NEXT LEFT PEAK, MIN DIP, NEXT DIP	

Continued on next page

Functions	Multimarker	Number of markers: 10 max. (HIGHEST 10, HARMONICS, MANUAL SET)
	Measure	Noise power (dBm/Hz, dBm/ch), C/N (dBc/Hz, dBc/ch), occupied bandwidth (power N% method, X-dB down method), adjacent channel power (REF: total power/reference level/in-band level method, channel designate display: 2 channels x 2 graphic display), average power of burst signal (average power in designated time range of time domain waveform), channel power (dBm, dBm/Hz), template comparison (upper/lower limits x each 2, time domain), MASK (upper/lower x each 2, frequency domain)
	Save/recall	Saves and recalls setting conditions and waveform data to internal memory (max. 12) or memory card
	Hard copy	Printer (HP dotmatrix, EPSON dotmatrix or compatible models): Display data can be hard-copied via RS-232C, GPIB, and Centronics (Option 10) interface Plotter (HP-GL, GP-GL compatible models): Display can be output via RS-232C and GPIB interface
	PTA	Language: PTL (interpreter based on BASIC) Programming: Using editor of external computer Program memory: Memory card, upload/download to/from external computer Programming capacity: 192 KB Data processing: Directly accesses measurement data according to system variables, system subroutines, and system functions
	RS-232C	Outputs data to printer and plotter. Control from external computer (excluding power switch)
	GPIB	Meets IEEE488.2. Controlled by external computer (excluding power switch). Or controls external equipment with PTA Interface function : SH1, AH1, T6, L4, SR1, RL1, PP0, DC1, DT1, C1, C2, C3, C4, C28
	Correction	Automatic correction of insertion loss of MA1621A Impedance Transformer Correction accuracy (RF ATT: ≥ 10 dB): ± 2.5 dB (9 to 100 kHz), ± 1.5 dB (100 kHz to 2 GHz), ± 2.0 dB (2 to 3 GHz) *Typical value Antenna correction coefficients: Correct display and measurement of field strengths (dB μ V/m) for specified antennas. Internal antenna correction coefficients (MP534A/651A Dipole Antenna, MP635A/666A Log-Periodic Antenna, MP414B Loop Antenna, and four antennas user-defined; writes via GPIB or RS-232C interface, saves/loads to/from memory card)
	Memory card interface	Functions: Saving/recalling measurement parameters/waveform data, uploading/downloading PTA programs; Applicable cards: SRAM, EPROM, Flash EPROM *Only SRAM writable; Card capacity: 2 MB max. Connector: Meets the PCMCIA Rel. 2.0, 2 slots
Others	EMC	EN61326: 1997/A1, 1998 (Class A) EN61000-3-2: 1995/A2, 1998 (Class A) EN61326: 1997/A1, 1998 (Annex A)
	LVD	EN610101-1: 1993/A2, 1995 (Installation Category II, Pollution degree 2)
	Vibration	Meets the MIL-STD-810D
	Power (operating range)	85 to 132/170 to 250 Vac (automatic voltage switching), 47.5 to 63 Hz, 380 to 420 Hz (85 to 132 V only), ≤ 330 VA
	Dimensions and mass	320 (W) x 177 (H) x 351 (D) mm, ≤ 10.8 kg (without option)
	Ambient temperature	0° to +50°C (operate), -40° to +75°C (storage)

• Option 01: Reference crystal oscillator

Frequency	10 MHz
Aging rate	$\leq 1 \times 10^{-7}$ /year, $\leq 2 \times 10^{-8}$ /day (after power on, with reference to frequency after 24 h)
Temperature characteristics	$\pm 5 \times 10^{-8}$ (0° to 50°C, with reference to 25°C)
Buffer output	BNC connector, 10 MHz, >2 Vp-p (200 Ω terminated)

• Option 02: Narrow resolution bandwidth

Resolution bandwidth (3 dB)	30 Hz, 100 Hz, 300 Hz
Resolution bandwidth switching uncertainty	± 0.4 dB (RBW 3 kHz referenced)
Resolution bandwidth accuracy	$\pm 20\%$ (100, 300 Hz)
Selectivity (60 dB:3 dB)	$\leq 15:1$ (RBW: 100, 300 Hz), $\leq 20:1$ (RBW: 30 Hz)

• Option 04: High-speed time domain sweep

Sweep time	12.5 μ s, 25 μ s, 50 μ s, 100 to 900 μ s (one most significant digit settable) 1.0 to 19 ms (two upper significant digits settable)
Accuracy	$\pm 1\%$
Marker level resolution	0.1 dB (log scale), 0.2% (linear scale, relative to reference level)

• Option 06: Trigger/gate circuit

Trigger switch	FREERUN, TRIGGERED	
Trigger source	EXT	Trigger level: ± 10 V (resolution: 0.1 V), TTL level Trigger slope: Rise/Fall Connector: BNC
	VIDEO	Trigger level (at log scale): -100 to 0 dB (resolution: 1 dB) Trigger slope: Rise/Fall
	WIDE IF VIDEO	Trigger level: High, middle, or low selectable Bandwidth: ≥ 20 MHz Trigger slope: Rise/Fall
	LINE	Frequency: 47.5 to 63 Hz (line lock)
TV	Method: M-NTSC, B/G/H PAL Sync: V-SYNC, H-SYNC Sync line (NTSC) H-SYNC (ODD): 7 to 262 line, H-SYNC (EVEN): 1 to 263 line Sync line (PAL) H-SYNC (ODD): 1 to 312 line, H-SYNC (EVEN): 317 to 625 line *Option 16 required	
Trigger delay	Pre-trigger (displays waveform from previous max. 1 screen at trigger occurrence point) Range: -time span to 0 s Resolution: time span/500 Post trigger (displays waveform from after max. 65.5 ms at trigger occurrence point) Range: 0 to 65.5 ms Resolution: 1 μ s	
Gate sweep	In frequency domain, displays spectrum of input signal in specified gate interval Gate delay: 0 to 65.5 ms (from trigger point, resolution: 1 μ s) Gate width: 2 μ s to 65.5 ms (from gate delay, resolution: 1 μ s)	

• Option 07: AM/FM demodulator

Voice output	With internal loudspeaker and earphone connector (ø3.5 jack), adjustable volume
--------------	---

• Option 10: Centronics interface

Function	Outputs data to printer (Centronics standard). GPIB interface cannot be installed simultaneously.
Connector	D-sub 25-pin (jack)

• Option 08: Pre-amplifier*1

Frequency range	100 kHz to 3 GHz, 100 kHz to 2.5 GHz (with Option 22)	
Noise figure	≤7 dB (typical, <2 GHz), ≤12 dB (typical, ≥2 GHz), ≤9 dB (typical, <2 GHz, with Option 22), ≤14 dB (typical, ≥2 GHz, with Option 22)	
Amplitude	Measurement range	Average noise level to +10 dBm
	Max. input level	CW average power: +10 dBm, ±50 Vdc
	Average noise level	≤-134 dBm (1 MHz to 1 GHz), ≤-134 dBm + 2f [GHz] dB (>1 GHz), ≤-132 dBm (1 MHz to 1 GHz, with Option 22), ≤-132 dBm + 2f [GHz] dB (≥1 GHz, with Option 22) *RBW: 1 kHz, VBW: 1 Hz, RF ATT: 0 dB
	Reference level	Setting range Log scale: -120 to +10 dBm, or equivalent level Linear scale: 22.4 μV to 707 mV, 27.4 μV to 487 mV with Option 22 Reference level accuracy: ±0.5 dB (-69.9 to -20 dBm), ±0.75 dB (-89.9 to -70 dBm, -19.9 to +10 dBm) *After calibration, referenced to 100 MHz, 1 MHz span (RF ATT, RBW, VBW and sweep time set to AUTO) RBW switching uncertainty: ±0.5 dB *After calibration, referenced to 3 kHz RBW RF ATT switching uncertainty: ±0.5 dB (0 to 50 dB), ±1.0 dB (0 to 70 dB) *After calibration, referenced to 100 MHz, RF ATT: 10 dB
	Frequency response	±2.0 dB (100 kHz to 3 GHz, referenced to 100 MHz, RF ATT: 10 to 50 dB) ±2.0 dB (with Option 22, 100 kHz to 2.5 GHz, referenced to 100 MHz, RF ATT: 10 dB, 18° to 28°C)
	Linearity of waveform display	Log scale (after calibration): ±0.5 dB (0 to -20 dB), ±1.0 dB (0 to -60 dB), ±1.5 dB (0 to -75 dB) Linear scale (after calibration): ±5% (according to reference level)
	Spurious response	Two signals 3rd order intermodulation distortion: ≤-70 dBc (10 MHz to 3 GHz, 10 MHz to 2.5 GHz with Option 22) *Frequency difference of two signals: ≥50 kHz, Pre-amplifier input*2: -55 dBm
	1 dB gain compression	≥-35 dBm (≥100 MHz, at pre-amplifier input level*2)

*1: Overall specification with pre-amplifier on (Noise figure is the simple performance)

*2: Pre-amplifier input level = RF input level - RF ATT setting level

• Option 12: QP detector

Functions	QP detection *Requires Option 02.																																											
6 dB bandwidth	200 Hz, 9 kHz, 120 kHz Accuracy: ±30% (18° to 28°C)																																											
Display	LOG scale, 5 dB/div (10 divisions) Linearity: ≤±2.0 dB (0 to -40 dB, CW signal, reference level: 60 dBμV, RF ATT: 0 dB, 18° to 28°C)																																											
Pulse response characteristics	Response to CISPR pulse (DET mode: QP, 18° to 28°C)																																											
	<table border="1"> <thead> <tr> <th rowspan="2">Repetition frequency</th> <th colspan="3">Bandwidth</th> </tr> <tr> <th>120 kHz</th> <th>9 kHz</th> <th>200 Hz</th> </tr> </thead> <tbody> <tr> <td>1 kHz</td> <td>≤-8.0 ±1.0 dB</td> <td>≤-4.5 ±1.0 dB</td> <td>-</td> </tr> <tr> <td>100 Hz</td> <td>Referenced</td> <td>Referenced</td> <td>≤-4.0 ±1.0 dB</td> </tr> <tr> <td>60 Hz</td> <td>-</td> <td>-</td> <td>≤-3.0 ±1.0 dB</td> </tr> <tr> <td>25 Hz</td> <td>-</td> <td>-</td> <td>Referenced</td> </tr> <tr> <td>20 Hz</td> <td>≤+9.0 ±1.0 dB</td> <td>≤+6.5 ±1.0 dB</td> <td>-</td> </tr> <tr> <td>10 Hz</td> <td>≤+14.0 ±1.5 dB</td> <td>≤+10.0 ±1.5 dB</td> <td>≤+4.0 ±1.0 dB</td> </tr> <tr> <td>5 Hz</td> <td>-</td> <td>-</td> <td>≤+7.5 ±1.5 dB</td> </tr> <tr> <td>2 Hz</td> <td>≤+26.0 ±2.0 dB</td> <td>≤+20.5 ±2.0 dB</td> <td>≤+13.0 ±2.0 dB</td> </tr> <tr> <td>1 Hz</td> <td>≤+28.5 ±2.0 dB</td> <td>≤+22.5 ±2.0 dB</td> <td>≤+17.0 ±2.0 dB</td> </tr> </tbody> </table>	Repetition frequency	Bandwidth			120 kHz	9 kHz	200 Hz	1 kHz	≤-8.0 ±1.0 dB	≤-4.5 ±1.0 dB	-	100 Hz	Referenced	Referenced	≤-4.0 ±1.0 dB	60 Hz	-	-	≤-3.0 ±1.0 dB	25 Hz	-	-	Referenced	20 Hz	≤+9.0 ±1.0 dB	≤+6.5 ±1.0 dB	-	10 Hz	≤+14.0 ±1.5 dB	≤+10.0 ±1.5 dB	≤+4.0 ±1.0 dB	5 Hz	-	-	≤+7.5 ±1.5 dB	2 Hz	≤+26.0 ±2.0 dB	≤+20.5 ±2.0 dB	≤+13.0 ±2.0 dB	1 Hz	≤+28.5 ±2.0 dB	≤+22.5 ±2.0 dB	≤+17.0 ±2.0 dB
	Repetition frequency		Bandwidth																																									
		120 kHz	9 kHz	200 Hz																																								
	1 kHz	≤-8.0 ±1.0 dB	≤-4.5 ±1.0 dB	-																																								
	100 Hz	Referenced	Referenced	≤-4.0 ±1.0 dB																																								
	60 Hz	-	-	≤-3.0 ±1.0 dB																																								
	25 Hz	-	-	Referenced																																								
	20 Hz	≤+9.0 ±1.0 dB	≤+6.5 ±1.0 dB	-																																								
	10 Hz	≤+14.0 ±1.5 dB	≤+10.0 ±1.5 dB	≤+4.0 ±1.0 dB																																								
5 Hz	-	-	≤+7.5 ±1.5 dB																																									
2 Hz	≤+26.0 ±2.0 dB	≤+20.5 ±2.0 dB	≤+13.0 ±2.0 dB																																									
1 Hz	≤+28.5 ±2.0 dB	≤+22.5 ±2.0 dB	≤+17.0 ±2.0 dB																																									
QP on/off switching uncertainty (PEAK, QP)	≤±1.0 dB (CW signal, reference level - 40 dB, after auto-calibration, 18° to 28°C)																																											
Detection mode	QP, AVERAGE																																											
Field strength measurement	Waveform data compensation data display for specified antenna factor, field strength (dBμV/m) Built-in antenna factors: MP534A/651A Dipole Antenna, MP635A/666A Log-Periodic Antenna, MP414B Loop Antenna, user-defined (four types writable via GPIB or RS-232C, can be saved/loaded to/from memory card)																																											

• Option 14: PTA parallel I/O

Functions	Controls external devices from PTA, cannot be installed when Option 10 installed																																																																															
System variables	As follows using PTA system variables IOA: Controls 8-bit parallel output port A IOB: Controls 8-bit parallel output port B IOC: Controls 4-bit parallel input/output port C	IOD: Controls 4-bit parallel input/output port D EIO: Controls I/O switching of ports C/D EXO: Controls I/O trigger																																																																														
PTL statements	External interrupt control of input to I/O ports using PTA-PTL statements IOEN statement: Enables interrupt input ON TO GOTO statement: Changes program flow at interrupt generation IODI statement: Disables interrupt input ON TO GOSUB statement: Changes program flow at interrupt generation IOMA statement: Masks interrupt input																																																																															
Write strobe signal	Write strobe signal (negative pulse) output externally at control of output ports C/D																																																																															
Power supply	External +5 ±0.5 Vdc (max. 100 mA) supply																																																																															
Signal logic levels	Negative logic, TTL level Specified current: Output ports A/B (max. output current Hi: 2.6 mA, Lo: 24 mA) Output ports C/D (max. output current Hi: 15 mA, Lo: 24 mA) Other control output lines (max. output current Hi: 0.4 mA, Lo: 8 mA)																																																																															
Connection cable connectors	Amphenol 36 pins																																																																															
Connector pin layout	<table border="1"> <thead> <tr> <th>No.</th> <th>Item</th> <th>No.</th> <th>Item</th> <th>No.</th> <th>Item</th> </tr> </thead> <tbody> <tr> <td>1</td> <td>GND</td> <td>13</td> <td>Output port B (0) LSB</td> <td>25</td> <td>I/O port D (0) LSB</td> </tr> <tr> <td>2</td> <td>Trigger input</td> <td>14</td> <td>Output port B (1)</td> <td>26</td> <td>I/O port D (1)</td> </tr> <tr> <td>3</td> <td>Trigger output 1</td> <td>15</td> <td>Output port B (2)</td> <td>27</td> <td>I/O port D (2)</td> </tr> <tr> <td>4</td> <td>Trigger output 2</td> <td>16</td> <td>Output port B (3)</td> <td>28</td> <td>I/O port D (3) MSB</td> </tr> <tr> <td>5</td> <td>Output port A (0) LSB</td> <td>17</td> <td>Output port B (4)</td> <td>29</td> <td>Port C status 0/1: I/O</td> </tr> <tr> <td>6</td> <td>Output port A (1)</td> <td>18</td> <td>Output port B (5)</td> <td>30</td> <td>Port D status 0/1: I/O</td> </tr> <tr> <td>7</td> <td>Output port A (2)</td> <td>19</td> <td>Output port B (6)</td> <td>31</td> <td>Write strobe signal</td> </tr> <tr> <td>8</td> <td>Output port A (3)</td> <td>20</td> <td>Output port B (7) MSB</td> <td>32</td> <td>Interruption signal</td> </tr> <tr> <td>9</td> <td>Output port A (4)</td> <td>21</td> <td>I/O port C (0) LSB</td> <td>33</td> <td>Not used</td> </tr> <tr> <td>10</td> <td>Output port A (5)</td> <td>22</td> <td>I/O port C (1)</td> <td>34</td> <td>+5 V power supply</td> </tr> <tr> <td>11</td> <td>Output port A (6)</td> <td>23</td> <td>I/O port C (2)</td> <td>35</td> <td>Not used</td> </tr> <tr> <td>12</td> <td>Output port A (7) MSB</td> <td>24</td> <td>I/O port C (3) MSB</td> <td>36</td> <td>Not used</td> </tr> </tbody> </table>		No.	Item	No.	Item	No.	Item	1	GND	13	Output port B (0) LSB	25	I/O port D (0) LSB	2	Trigger input	14	Output port B (1)	26	I/O port D (1)	3	Trigger output 1	15	Output port B (2)	27	I/O port D (2)	4	Trigger output 2	16	Output port B (3)	28	I/O port D (3) MSB	5	Output port A (0) LSB	17	Output port B (4)	29	Port C status 0/1: I/O	6	Output port A (1)	18	Output port B (5)	30	Port D status 0/1: I/O	7	Output port A (2)	19	Output port B (6)	31	Write strobe signal	8	Output port A (3)	20	Output port B (7) MSB	32	Interruption signal	9	Output port A (4)	21	I/O port C (0) LSB	33	Not used	10	Output port A (5)	22	I/O port C (1)	34	+5 V power supply	11	Output port A (6)	23	I/O port C (2)	35	Not used	12	Output port A (7) MSB	24	I/O port C (3) MSB	36	Not used
No.	Item	No.	Item	No.	Item																																																																											
1	GND	13	Output port B (0) LSB	25	I/O port D (0) LSB																																																																											
2	Trigger input	14	Output port B (1)	26	I/O port D (1)																																																																											
3	Trigger output 1	15	Output port B (2)	27	I/O port D (2)																																																																											
4	Trigger output 2	16	Output port B (3)	28	I/O port D (3) MSB																																																																											
5	Output port A (0) LSB	17	Output port B (4)	29	Port C status 0/1: I/O																																																																											
6	Output port A (1)	18	Output port B (5)	30	Port D status 0/1: I/O																																																																											
7	Output port A (2)	19	Output port B (6)	31	Write strobe signal																																																																											
8	Output port A (3)	20	Output port B (7) MSB	32	Interruption signal																																																																											
9	Output port A (4)	21	I/O port C (0) LSB	33	Not used																																																																											
10	Output port A (5)	22	I/O port C (1)	34	+5 V power supply																																																																											
11	Output port A (6)	23	I/O port C (2)	35	Not used																																																																											
12	Output port A (7) MSB	24	I/O port C (3) MSB	36	Not used																																																																											

• Option 15: Sweep signal output

Sweep output (X)	0 to 10 V ±1 V (≥100 kΩ termination, from left side to right side of display scale), BNC connector
Sweep status output (Z)	TTL level (low level with sweeping), BNC connector

• Option 19: DC coupled input

Functions	DC-couples input circuit of main unit and expands lower limit of receiver frequency range to 500 Hz *Can only be installed with narrow RBW (Option 02)
Electrical characteristics	The standard specifications of the main unit are supplemented and changed as follows: Frequency range: 500 Hz to 3.0 GHz Max. input level: +30 dBm (CW, RF ATT: ≥10 dB), ±0 Vdc Average noise level: <-80 dBm (500 Hz to 10 kHz), ≤-90 dBm (10 kHz to 200 kHz), ≤-110 dBm (200 kHz to 1 MHz) *RBW: 30 Hz, VBW: 1 Hz, RF ATT: 0 dB Frequency response: ±1.2 dB (500 Hz to 100 kHz), ±0.5 dB (100 kHz to 3 GHz) *Referenced to 100 MHz frequency, RF ATT: 10 dB, 18° to 28°C

• Option 20: Tracking generator

Frequency range	9 kHz to 3 GHz
Output level range	0 to -60 dBm
Setting resolution	0.1 dB
Output level accuracy	≤±1.0 dB (at 100 MHz, 0 dBm)
Output level flatness	≤±1.5 dB (100 kHz to 3 GHz, output level: 0 dBm, referenced to 100 MHz frequency)
Output level linearity	≤±1.0 dB (0 to -30 dBm), ≤±2.0 (-30 to -60 dBm) *100 kHz to 3 GHz, 0 dBm output level reference
Spurious	Harmonic: ≤-20 dBc (100 kHz to 3 GHz), Non-harmonic: ≤-35 dBc (100 kHz to 3 GHz)
Tracking generator feed through	≤-95 dBm (spectrum analyzer input and tracking generator output connectors terminated at 50 Ω)
Output connector	N-J, 50 Ω

• Option 21: Television monitor (Multi)

Video	M-NTSC, B/G/H/I/D PAL, color
Audio	Simultaneous monitoring of video and audio *Needs Option 07
Function	Channel: Automatic setting to broadcast wave of CCIR, Japan, USA, Italy, UK and China; automatic setting to CATV of CCIR, Japan and USA Trigger: Triggered sweep by V-SYNC, H-SYNC *Needs trigger/gate circuit (Option 06) Aux. output: Composite video signal; Connector: BNC

• **Option 22: 75 Ω input (Option 12, 19, and 20 cannot be installed simultaneously)**

Frequency range	100 kHz to 2.5 GHz
Amplitude	Level measurement Measurement range: Average noise level to +25 dBm (+133.8 dBμV) Max. input level: +25 dBm (+133.8 dBμV, CW average power, RF ATT: ≥10 dB), ±100 Vdc Residual response: ≤−95 dBm (+13.8 dBμV, RF ATT: 0 dB, input: 75 Ω terminated, 1 MHz to 2.5 GHz)
	Total level accuracy ±1.8 dB (100 kHz to 2.5 GHz, level measurement accuracy after calibration using internal calibration signal) Total level accuracy: Reference level accuracy (0 to −49.9 dBm) + frequency response + log linearity (0 to −20 dBm) + calibration signal source accuracy
	Reference level Setting range Log scale: +8.8 to +133.8 dBμV, Linear scale: 274 μV to 4.87 V
	Frequency response ±1.0 dB (100 kHz to 2.5 GHz, referenced to 100 MHz, RF ATT: 10 dB, 18° to 28°C)
	Waveform display Linearity (after calibration) Log scale: ±0.4 dB (0 to −20 dB), ±1.0 dB (0 to −70 dB), ±1.5 dB (0 to −85 dB) Linear scale: ±4% (according to reference level) Marker level resolution Log scale: 0.01 dB Linear scale: 0.02% (according to reference level)
	Spurious response 2nd harmonic distortion: ≤−60 dBc (10 to 200 MHz, mixer input: −30 dBm), ≤−75 dBc (0.2 to 1.25 GHz, band 0, mixer input: −30 dBm), ≤−80 dBc (0.8 to 1 GHz, mixer input: −30 dBm) Two signals 3rd order intermodulation distortion: ≤−70 dBc (10 to 100 MHz), ≤−80 dBc (0.1 to 2.5 GHz) *Frequency difference of two signals: ≥50 kHz, mixer input: −30 dBm
Max. dynamic range 1 dB gain compression level to average noise level: >110 dB (0.1 to 1 GHz), >110 dB − f [GHz] dB (>1 GHz), >109 dB (0.1 to 1 GHz, with Option 08), >109 dB − 1.5f [GHz] dB (>1 GHz with Option 08) Distortion characteristics (RBW: 1 kHz) 2nd harmonic: >72.5 dB (10 to 200 MHz), >80 dB (200 to 500 MHz), >80 − f [GHz] dB (0.5 to 1.25 GHz), >82.5 − f [GHz] dB (0.8 to 1 GHz) 3rd order intermodulation: >80 dB (10 to 100 MHz), >83.3 dB (0.1 to 1 GHz), >83.3 dB − (2/3)f [GHz] dB (1 to 2.5 GHz)	
Functions	Input connector NC-J, 75 Ω
	Auxiliary I/O VIDEO OUTPUT (Y): 0 to 0.5 V ±0.1 V (typical; from lower edge to upper edge at 10 dB/div, 100 MHz, 75 Ω terminated) 0 to 0.4 V ±0.1 V (typical; from lower edge to upper edge at 10%/div, 100 MHz, 75 Ω terminated), BNC connector

6

• **Option 23: 75 Ω tracking generator (Option 12, 19, and 20 cannot be installed simultaneously)**

Frequency range	100 kHz to 2.5 GHz
Output level range	+44 to +104 dBμV (setting resolution: 0.1 dB)
Output level accuracy	≤±1.5 dB (100 MHz, output level: +104 dBμV)
Output level flatness	≤±1.75 dB (100 kHz to 2.5 GHz, output level: +104 dBμV, referenced to 100 MHz)
Output level linearity	≤±1.0 dB (+74 to +104 dBμV), ≤±2.0 dB (+44 to +74 dBμV) *100 kHz to 2.5 GHz, referenced to +104 dBμV
Spurious	Harmonics: ≤−20 dBc (100 kHz to 2.5 GHz), Non-harmonics: ≤−30 dBc (100 kHz to 2.5 GHz)
Tracking generator feed through	≤13.8 dBμV (spectrum analyzer input and tracking generator output connectors terminated at 75 Ω)
Output connector	NC-J, 75 Ω

• **Option 24: Television monitor (Brazil)**

Video	M-NTSC, M PAL, color
Audio	Simultaneous monitoring of video and audio *Needs Option 07
Functions	Channel: Automatic setting to broadcast wave of CCIR, Japan and USA; automatic setting to CATV of CCIR, Japan and USA Trigger: Triggered sweep by V-SYNC, H-SYNC *Needs trigger/gate circuit (Option 06) Aux. output: Composite video signal, Connector: BNC

Ordering information

Please specify model/order number, name, and quantity when ordering.

Model/order No.	Name	Model/order No.	Name
MS2661C	Main frame Spectrum Analyzer	J0076	Coaxial adapter (NC-P · F-J)
	Standard accessories	B0391A	Carrying case (hard type, with casters)
	Power cord, 2.6 m: 1 pc	B0391B	Carrying case (hard type, without casters)
F0013	Fuse, 5 A: 2 pcs	MP612A	RF Fuse Holder
W1251AE	MS2650B, MS2660B/C series operation manual: 1 copy	MP613A	Fuse Element
B0329G	Front cover (3/4MW4U)	J0805	DC Block (MODEL 7003, 10 kHz to 18 GHz, ±50 V, Weinschel product)
	Options	MA2507A	DC Block Adapter (50 Ω, 9 kHz to 3 GHz, ±50 V)
MS2661C-01	Reference crystal oscillator	MA8601A	DC Block Adapter (50 Ω, 30 kHz to 2 GHz, ±50 V)
MS2661C-02	Narrow resolution bandwidth	MA8601J	DC Block Adapter (75 Ω, 10 kHz to 2.2 GHz, ±50 V)
MS2661C-04	High-speed time domain sweep	MA1621A	50 Ω → 75 Ω Impedance Transformer (9 kHz to 3 GHz, ±100 V)
MS2661C-06	Trigger/gate circuit	MP614A	50 Ω ↔ 75 Ω Impedance Transformer
MS2661C-07	AM/FM demodulator	J0121	Coaxial cord (NC-P-3W · 3C-2WS · NC-P-3W), 1 m
MS2661C-08	Pre-amplifier	J0308	Coaxial cord (BNC-P · 3C-2WS · NC-P-3W), 1 m
MS2661C-10	Centronics interface (GPIB cannot be installed simultaneously.)	J0063	Fixed attenuator for high power (30 dB, 10 W, DC to 12.4 GHz)
MS2661C-12	QP detector (requires Option 02, QP-BW: 0.2/9/120 kHz)	J0395	Fixed attenuator for high power (30 dB, 30 W, DC to 9 GHz)
MS2661C-14	PTA parallel I/O (Option 10 cannot be installed simultaneously.)	MP640A	Branch
MS2661C-15	Sweep signal output	MP654A	Branch
MS2661C-19	DC coupled input (requires Option 02)	MP520A	CM Directional Coupler
MS2661C-20	Tracking generator	MP520B	CM Directional Coupler
MS2661C-21	Television monitor (Multi)	MP520C	CM Directional Coupler
MS2661C-22	75 Ω input (Option 12, 19 and 20 can not be installed simultaneously.)	MP520D	CM Directional Coupler
MS2661C-23	75 Ω tracking generator (Option 12, 19 and 20 can not be installed simultaneously.)	MP526A	High Pass Filter
MS2661C-24	Television monitor (Brazil)	MP526B	High Pass Filter
	Application parts	MP526C	High Pass Filter
MX260002A	CDMA Cellular System Measurement Software	MP526D	High Pass Filter
MX260003A	PDC Measurement Software (for base station)	MP526G	High Pass Filter
MX260004A	GSM Measurement Software	MA1601A	High Pass Filter (800/900 MHz band, N)
MX261001A	Low-Power Data Communication System Measurement Software conforming to issue of Direct Spread Spectrum System	J0007	GPIB cable, 1 m
MX261002A	Low-Power Data Communication System Measurement Software conforming to issue of Frequency Hopping System	J0008	GPIB cable, 2 m
MX262001A	CATV Measurement Software	J0742A	RS-232C cable, 1 m [for PC-98 Personal Computer and VP-600, D-sub 25 pins (straight)]
MX264001A	EMI Measurement Software	J0743A	RS-232C cable, 1 m [for AT compatible, D-sub 9-pins (cross)]
J0561	Coaxial cord (N-P-5W · 5D-2W · N-P-5W), 1 m	60N50-1	Reflection bridge
J0104A	Coaxial cord (BNC-P · RG-55/U · N-P), 1 m	60NF50-1	Reflection bridge
CSCJ-256K-SM	256 KB memory card (meets PCMCIA Rel. 2.0)	87A50	Reflection bridge
CSCJ-512K-SM	512 KB memory card (meets PCMCIA Rel. 2.0)	62N75	Reflection bridge
CSCJ-001M-SM	1024 KB memory card (meets PCMCIA Rel. 2.0)	62NF75	Reflection bridge
CSCJ-002M-SM	2048 KB memory card (meets PCMCIA Rel. 2.0)	MH648A	Pre-Amplifier
B0395A	Rack mount kit (IEC)	MP534A	Dipole Antenna
B0395B	Rack mount kit (JIS)	MP651A	Dipole Antenna
J0055	Coaxial adapter (NC-P · BNC-J)	BBA9106/VHA9103	Biconical Antenna
		MP635A	Log-Periodic Antenna
		MP666A	Log-Periodic Antenna
		MB9A	Tripod
		MB19A	Tripod
		MA2601B	EMI Probe
		MA2601C	EMI Probe
		KT-10	EMI Clamp
		KT-20	EMI Clamp

SPECTRUM ANALYZER
MS2651B/2661B
 9 kHz to 3 GHz

For Maintaining CATV Circuits



The MS2651B/2661B Portable Spectrum Analyzers are for use in signal analysis of radio and other equipment related to improving frequency usage efficiency, higher modulation, and digitalization. They are synthesized spectrum analyzers covering a wide frequency range from 9 kHz to 3 GHz. They have superior basic performance such as high C/N ratio, low distortion, and high frequency/level accuracies and are easy to operate. They have the "Measure" function for evaluation of radio equipment (frequency counter, C/N, adjacent

channel power, occupied frequency bandwidth, burst average power, and template decision function) and which enables the two-screen display and FM demodulation waveform display. The large selection of options means a wider range of applications can be handled at reasonable cost. The MS2661B is designed for manufacture and installation of radio equipment and devices, while the MS2651B is used for maintenance applications.

Specifications

Except where noted otherwise, specified values are obtained after warming up the equipment for 30 minutes at a constant ambient temperature and then performing calibration. The typical values are given for reference and are not guaranteed.

Model	MS2651B	MS2661B
Frequency range	9 kHz to 3 GHz	
Display frequency accuracy	± (display frequency x reference frequency accuracy + span x span accuracy + 100 Hz) *Span: ≥10 kHz, after calibration	
Marker frequency display accuracy	Normal: Same as display frequency accuracy; Delta: Same as frequency span accuracy	
Frequency counter	Resolution: 1 Hz, 10 Hz, 100 Hz, 1 kHz Accuracy: Display frequency x reference frequency accuracy ±1 LSD (at S/N: ≥20 dB)	
Frequency span	Setting range: 0 Hz, 1 kHz to 3.1 GHz Accuracy: ±2.5% (span: ≥10 kHz)	Setting range: 0 Hz, 1 kHz to 3.1 GHz Accuracy: ±2.5% (span: ≥10 kHz) ±5% (span: <10 kHz, with option 02)
Resolution bandwidth (RBW) (3 dB bandwidth)	Setting range: 1 kHz, 3 kHz, 10 kHz, 30 kHz, 100 kHz, 300 kHz, 1 MHz, 5 MHz (manually settable, or automatically settable according to frequency span) *Option 02 (MS2661B only): 30 Hz, 100 Hz, and 300 Hz are added. Measurements of noise, C/N, adjacent channel power, and channel power by measure function are executed with the calculated equivalent noise bandwidth of the RBW. Selectivity (60 dB : 3 dB): ≤10:1 (RBW: 1 to 300 kHz), ≤15:1 (RBW: 1, 5 MHz)	
Video bandwidth (VBW)	1 Hz to 3 MHz (1-3 sequence), OFF (manually settable, or automatically settable according to RBW)	
Noise sideband, stability	Noise sideband: ≤-90 dBc/Hz (1 GHz, 10 kHz offset)	Noise sideband: ≤-100 dBc/Hz (1 GHz, 10 kHz offset)
Reference oscillator	Frequency: 10 MHz Aging rate: 2 x 10 ⁻⁶ /year (typical); Option 01: 1 x 10 ⁻⁷ /year, 2 x 10 ⁻⁸ /day Temperature characteristics: 1 x 10 ⁻⁵ (typical, 0° to 50°C); Option 01: ±5 x 10 ⁻⁸ (0° to 50°C, referenced to 25°C)	

Continued on next page

Model		MS2651B	MS2661B	
Amplitude	Level measurement	Measurement range: Average noise level to +30 dBm Maximum input level: +30 dBm (CW average power, RF ATT: ≥ 10 dB), ± 50 Vdc Average noise level: ≤ -110 dBm (1 MHz to 1 GHz), ≤ -110 dBm + f [GHz] dB (>1 GHz) *RBW: 1 kHz, VBW: 1 Hz, RF ATT: 0 dB Residual response: ≤ -95 dBm (RF ATT: 0 dB, input: 50 Ω termination, 1 MHz to 3 GHz)	Average noise level: ≤ -115 dBm (1 MHz to 1 GHz), ≤ -115 dBm + f [GHz] dB (>1 GHz), ≤ -114 dBm (1 MHz to 1 GHz, at Option 08 pre-amplifier installed), ≤ -114 dBm + 1.5f [GHz] dB (>1 MHz, at Option 08 pre-amplifier installed) *RBW: 1 kHz, VBW: 1 Hz, RF ATT: 0 dB Residual response: ≤ -100 dBm (RF ATT: 0 dB, input: 50 Ω termination, 1 MHz to 3 GHz)	
	Total level accuracy	± 1.3 dB (100 kHz to 3 GHz) *Level measurement accuracy after calibration using internal calibration signal Total level accuracy: Reference level accuracy (0 to -49.9 dBm) + frequency response + log linearity (0 to -20 dB) + calibration signal source accuracy		
	Reference level	Setting range Log scale: -100 to +30 dBm; Linear scale: 224 μ V to 7.07 V Unit Log scale: dBm, dB μ V, dBmV, V, dB μ Vemf, W, dB μ V/m Linear scale: V Reference level accuracy: ± 0.4 dB (-49.9 to 0 dBm), ± 0.75 dB (-69.9 to -50 dBm, 0.1 to +30 dBm), ± 1.5 dB (-80 to -70 dBm) *After calibration, at 100 MHz, span: 1 MHz (when RF ATT, RBW, VBW, and sweep time set to AUTO) RBW switching uncertainty: ± 0.3 dB (1 kHz to 1 MHz), ± 0.4 dB (5 MHz) *After calibration, referenced to RBW: 3 kHz Input attenuator (RF ATT) Setting range: 0 to 70 dB (10 dB steps) *Manually settable, or automatically settable according to reference level Switching uncertainty: ± 0.3 dB (0 to 50 dB), ± 1.0 dB (0 to 70 dB) *After calibration, frequency: 100 MHz, referenced to RF ATT: 10 dB		
	Frequency response	± 0.5 dB (100 kHz to 3 GHz, referenced to 100 MHz, RF ATT: 10 dB, 18° to 28°C) ± 1.5 dB (9 to 100 kHz, referenced to 100 MHz, RF ATT: 10 dB, 18° to 28°C) ± 1.0 dB (100 kHz to 3 GHz, referenced to 100 MHz, RF ATT: 10 to 50 dB)		
	Waveform display	Scale (10 div) Log scale: 10, 5, 2, 1 dB/div Linear scale: 10, 5, 2, 1%/div Linearity (after calibration) Log scale: ± 0.4 dB (0 to -20 dB, RBW: ≤ 1 MHz), ± 1.0 dB (0 to -70 dB, RBW: ≤ 100 kHz), ± 1.5 dB (0 to -85 dB, RBW: ≤ 3 kHz), ± 2.5 dB (0 to -90 dB, RBW: ≤ 3 kHz) Linear scale: $\pm 4\%$ (compared to reference level) Marker level resolution Log scale: 0.01 dB, Linear scale: 0.02% of reference level		
	Spurious response	2nd harmonic distortion: ≤ -55 dBc (10 to 100 MHz), ≤ -60 dBc (0.1 to 1.5 GHz) *Mixer input: -30 dBm Two signals 3rd order intermodulation distortion: ≤ -70 dBc (10 MHz to 3 GHz) *Frequency difference of two signals: ≥ 50 kHz, mixer input: -30 dBm	2nd harmonic distortion: ≤ -60 dBc (10 to 200 MHz), ≤ -75 dBc (0.2 to 1.5 GHz), ≤ -80 dBc (0.8 to 1 GHz) *Mixer input: -30 dBm Two signals 3rd order intermodulation distortion: ≤ -70 dBc (10 to 100 MHz), ≤ -80 dBc (0.1 to 3 GHz) *Frequency difference of two signals: ≥ 50 kHz, mixer input : -30 dBm	
	1 dB gain compression	≥ -5 dBm (≥ 100 MHz, at mixer input)		
	Maximum dynamic range	1 dB gain compression level to average noise level: > 105 dB (0.1 to 1 GHz), > 105 dB - f [GHz] dB (>1 GHz) Distortion characteristics (RBW: 1 kHz) 2nd harmonic: > 67.5 dB (10 to 100 MHz), > 70 dB (100 to 500 MHz), $> 70 - f$ [GHz] dB (0.5 to 1.5 GHz) 3rd order intermodulation : > 76.6 dB (10 MHz to 1 GHz), $> 76.6 - (2/3)f$ [GHz] dB (1 to 3 GHz)	1 dB gain compression level to average noise level: > 110 dB (0.1 to 1 GHz), > 110 dB - f [GHz] dB (>1 GHz), > 109 dB (0.1 to 1 GHz, at Option 08 pre-amplifier installed) > 109 dB - 1.5f [GHz] (>1 GHz, at Option 08 pre amplifier installed) Distortion characteristics (RBW: 1 kHz) 2nd harmonic: > 72.5 dB (10 to 200 MHz), > 80 dB (200 to 500 MHz), $> 80 - f$ [GHz] dB (0.5 to 1.5 GHz) $> 82.5 - f$ [GHz] dB (0.8 to 1 GHz) 3rd order intermodulation: > 80 dB (10 to 100 MHz), > 83.3 dB (0.1 to 1 GHz), $> 83.3 - (2/3)f$ [GHz] dB (1 to 3 GHz)	
	Sweep	Sweep time	Setting range : 20 ms to 1000 s (Manually settable, or automatically settable according to span, RBW and VBW) Accuracy: $\pm 15\%$ (20 ms to 100 s), $\pm 45\%$ (110 to 1000 s), $\pm 1\%$ (time domain sweep: digital zero span mode)	
		Sweep mode	Continuous, single	
Time domain sweep mode		Analog zero span, digital zero span		
Zone sweep		Sweeps only in frequency range indicated by zone marker		
Tracking sweep		Sweeps while tracing peak points within zone marker (zone sweep also possible)		
Functions	Number of data points	501		
	Detection mode	NORMAL: Simultaneously displays max. and min. points between sample points POS PEAK: Displays max. point between sample points NEG PEAK: Displays min. point between sample points SAMPLE: Displays momentary value at sample points Detection mode switching uncertainty: ± 0.5 dB (at reference level)		
	Display	Color TFT-LCD, Size: 5.5 inch, Number of colors: 17 (RGB, each 64-scale settable); Intensity adjustment: 5 steps settable		

Continued on next page

Model		MS2651B	MS2661B
Functions	Display functions	Trace A: Displays frequency spectrum Trace B: Displays frequency spectrum Trace Time: Displays time domain waveform at center frequency Trace A/B: Displays Trace A and Trace B simultaneously. Simultaneous sweep of same frequency, alternate sweep of independent frequencies Trace A/BG: Displays frequency region to be observed (background) and object band (foreground) selected from background with zone marker simultaneously at alternate sweep Trace A/Time: Displays frequency spectrum, and time domain waveform at center frequency simultaneously at alternate sweep Trace move/calculation: A → B, B → A, A ↔ B, A + B → A, A - B → A, A - B + DL → A	
	Storage functions	NORMAL, VIEW, MAX HOLD, MIN HOLD, AVERAGE, CUMULATIVE, OVER WRITE	
	FM demodulation waveform display function	Demodulation range: 2, 5, 10, 20, 50, 100, 200 kHz/div Marker display accuracy: ±5% of full scale (referenced to center frequency, DC-coupled, RBW: 5 MHz, VBW: 1 Hz, CW) Demodulation frequency response: DC (50 Hz at AC-coupled) to 100 kHz *Range: ≤20 kHz/div, VBW: off, at 3 dB bandwidth DC (50 Hz at AC-coupled) to 500 kHz *Range: ≥50 kHz/div, VBW: off, at 3 dB bandwidth *RBW: ≥100 kHz usable	
	Input connector	N-J, 50 Ω	
	Auxiliary signal input and output	IF OUTPUT: 455 kHz (RBW: ≤30 kHz), 10.695 MHz (RBW: ≥100 kHz), BNC connector VIDEO OUTPUT (Y): 0 to 0.5 V ±0.1 V (100 MHz, from lower edge to upper edge at 10 dB/div or 10%/div, 75 Ω terminated, BNC connector) COMPOSITE OUTPUT: For NTSC, 1 Vp-p (75 Ω terminated), BNC connector EXT REF INPUT: 10 MHz ±10 Hz, ≥0 dBm (50 Ω terminated), BNC connector	
	Signal search	AUTO TUNE, PEAK → CF, PEAK → REF, SCROLL	
	Zone marker	NORMAL, DELTA	
	Marker →	MARKER → CF, MARKER → REF, MARKER → CF STEP SIZE, ΔMARKER → SPAN, ZONE → SPAN	
	Peak search	PEAK, NEXT PEAK, NEXT RIGHT PEAK, NEXT LEFT PEAK, MIN DIP, NEXT DIP	
	Multimarker	Number of markers: 10 max. (HIGHEST 10, HARMONICS, MANUAL SET)	
	Measure	Noise power (dBm/Hz, dBm/ch), C/N (dBc/Hz, dBc/ch), occupied bandwidth (power N% method, X-dB down method), adjacent channel power (REF: total power/reference level/in-band level method, channel designate display: 2 channels x 2 graphic display), average power of burst signal (average power in designated time range of time domain waveform), channel power (dBm, dBm/Hz), template comparison (upper/lower limits x each 2, time domain), MASK (upper/lower x each 2, frequency domain)	
	Save/recall	Saves and recalls setting conditions and waveform data to internal memory (max. 12) or memory card	
	Hard copy	Printer (HP dotmatrix, EPSON dotmatrix or compatible models): Display data can be hard-copied via RS-232C, GPIB, and Centronics (Option 10) interface Plotter (HP-GL, GP-GL compatible models): Display can be output via RS-232C and GPIB interface	
	PTA	Language: PTL (interpreter based on BASIC) Programming: Using editor of external computer Program memory: Memory card, upload/download to/from external computer Programming capacity: 192 kB Data processing: Directly accesses measurement data according to system variables, system subroutines, and system functions	
	RS-232C	Outputs data to printer and plotter. Control from external computer (excluding power switch)	
	GPIB	Meets IEEE488.2. Controlled by external computer (excluding power switch). Or controls external equipment with PTA Interface function: SH1, AH1, T6, L4, SR1, RL1, PP0, DC1, DT1, C1, C2, C3, C4, C28	
Correction	Automatic correction of insertion loss of MA1621A Impedance Transformer Correction accuracy (RF ATT: ≥10 dB): ±2.5 dB (9 to 100 kHz), ±1.5 dB (100 kHz to 2 GHz), ±2.0 dB (2 to 3 GHz) *Typical value Antenna correction coefficients: Correct display and measurement of field strengths (dBμV/m) for specified antennas. Internal antenna correction coefficients (MP534A/651A Dipole Antenna, MP635A/666A Log-Periodic Antenna, MP414B Loop Antenna, and four antennas user-defined; writes via GPIB or RS-232C interface, saves/loads to/from memory card)		
Memory card interface	Functions: Saving/recalling measurement parameters/waveform data, uploading/downloading PTA programs; Applicable cards: SRAM, EPROM, Flash EPROM *Only SRAM writable; Card capacity: 2 MB max. Connector: Meets the PCMCIA Rel. 2.0, 2 slots		
Others	EMC	EN61326: 1997/A1, 1998 (Class A) EN61000-3-2: 1995/A2, 1998 (Class A) EN61326: 1997/A1, 1998 (Annex A)	-
	LVD	EN610101-1: 1993/A2, 1995 (Installation Category II, Pollution degree 2)	-
	Vibration	Meets the MIL-STD-810D	
	Power (operating range)	85 to 132/170 to 250 Vac (automatic voltage switching), 47.5 to 63 Hz, 380 to 420 Hz (85 to 132 V only), ≤320 VA	
	Dimensions and mass	320 (W) x 177 (H) x 351 (D) mm, ≤10.8 kg (without option)	
Ambient temperature	0° to +50°C (operate), -40° to +75°C (storage)		

• Option 01: Reference crystal oscillator

Frequency	10 MHz
Aging rate	$\leq 1 \times 10^{-7}$ /year, $\leq 2 \times 10^{-8}$ /day (after power on, with reference to frequency after 24 h)
Temperature characteristics	$\pm 5 \times 10^{-8}$ (0° to 50°C, with reference to 25°C)
Buffer output	BNC connector, 10 MHz, >2 Vp-p (200 Ω terminated)

• Option 02: Narrow resolution bandwidth (MS2661B only)

Resolution bandwidth (3 dB)	30 Hz, 100 Hz, 300 Hz
Resolution bandwidth switching uncertainty	± 0.4 dB (RBW 3 kHz referenced)
Selectivity (60 dB:3 dB)	$\leq 15:1$ (RBW: 100, 300 Hz), $\leq 20:1$ (RBW: 30 Hz)

• Option 04: High-speed time domain sweep

Sweep time	12.5 μs, 25 μs, 50 μs, 100 to 900 μs (one most significant digit settable) 1.0 to 19 ms (two upper significant digits settable)
Accuracy	$\pm 1\%$
Marker level resolution	0.1 dB (log scale), 0.2% (linear scale, relative to reference level)

• Option 07: AM/FM demodulator

Voice output	With internal loudspeaker and earphone connector (ø3.5 jack), adjustable volume
--------------	---

• Option 06: Trigger/gate circuit

Trigger switch	FREERUN, TRIGGERED	
Trigger source	EXT	Trigger level: ± 10 V (resolution: 0.1 V), TTL level Trigger slope: Rise/Fall Connector: BNC
	VIDEO	Trigger level (at log scale): -100 to 0 dB (resolution: 1 dB) Trigger slope: Rise/Fall
	WIDE IF VIDEO	Trigger level: High, middle, or low selectable Bandwidth: ≥ 20 MHz Trigger slope: Rise/Fall
	LINE	Frequency: 47.5 to 63 Hz (line lock)
TV		Method: M-NTSC, B/G/H PAL Sync: V-SYNC, H-SYNC Sync line (NTSC) H-SYNC (ODD): 7 to 262 line, H-SYNC (EVEN): 1 to 263 line Sync line (PAL) H-SYNC (ODD): 1 to 312 line, H-SYNC (EVEN): 317 to 625 line *Option 16 required
Trigger delay	Pre-trigger (displays waveform from previous max. 1 screen at trigger occurrence point) Range: -time span to 0 s Resolution: time span/500 Post trigger (displays waveform from after max. 65.5 ms at trigger occurrence point) Range: 0 to 65.5 ms Resolution: 1 μs	
Gate sweep	In frequency domain, displays spectrum of input signal in specified gate interval Gate delay: 0 to 65.5 ms (from trigger point, resolution: 1 μs) Gate width: 2 μs to 65.5 ms (from gate delay, resolution: 1 μs)	

• Option 08: Pre-amplifier*1

Frequency range	100 kHz to 3 GHz, 100 kHz to 2.5 GHz (with Option 22)	
Noise figure	≤ 7 dB (typical, <2 GHz), ≤ 12 dB (typical, ≥ 2 GHz), ≤ 9 dB (typical, <2 GHz, with Option 22), ≤ 14 dB (typical, ≥ 2 GHz, with Option 22)	
Amplitude	Measurement range	Average noise level to +10 dBm
	Max. input level	CW average power: +10 dBm, ± 50 Vdc
	Average noise level	MS2651B: ≤ -130 dBm (1 MHz to 1 GHz), ≤ -130 dBm + 1.5f [GHz] dB (>1 GHz) MS2661B: ≤ -134 dBm (1 MHz to 1 GHz), ≤ -134 dBm + 2f [GHz] dB (>1 GHz), ≤ -132 dBm (1 MHz to 1 GHz, with Option 22), ≤ -132 dBm + 2f [GHz] dB (≥ 1 GHz, with Option 22) *RBW: 1 kHz, VBW: 1 Hz, RF ATT: 0 dB
	Reference level	Setting range Log scale: -120 to +10 dBm, or equivalent level Linear scale: 22.4 μV to 707 mV, 27.4 μV to 487 mV with Option 22 Reference level accuracy: ± 0.5 dB (-69.9 to -20 dBm), ± 0.75 dB (-89.9 to -70 dBm, -19.9 to +10 dBm) *After calibration, referenced to 100 MHz, span: 1 MHz (RF ATT, RBW, VBW and sweep time set to AUTO) RBW switching uncertainty: ± 0.5 dB *After calibration, referenced to RBW: 3 kHz RF ATT switching uncertainty: ± 0.5 dB (0 to 50 dB), ± 1.0 dB (0 to 70 dB) *After calibration, referenced to 100 MHz, RF ATT: 10 dB
	Frequency response	± 2.0 dB (100 kHz to 3 GHz, referenced to 100 MHz, RF ATT: 10 to 50 dB) ± 2.0 dB (with Option 22, 100 kHz to 2.5 GHz, referenced to 100 MHz, RF ATT: 10 dB, 18° to 28°C)
	Linearity of waveform display	Log scale (after calibration): ± 0.5 dB (0 to -20 dB), ± 1.0 dB (0 to -60 dB), ± 1.5 dB (0 to -75 dB) Linear scale (after calibration): $\pm 5\%$ (according to reference level)
	Spurious response	Two signals 3rd order intermodulation distortion: ≤ -70 dBc (10 MHz to 3 GHz, 10 MHz to 2.5 GHz with Option 22) *Frequency difference of two signals: ≥ 50 kHz; Pre-amplifier input*2: -55 dBm
	1 dB gain compression	≥ -35 dBm (≥ 100 MHz, at pre-amplifier input*2)

*1: Overall specification with pre-amplifier on (Noise figure is the simple performance)

*2: Pre-amplifier input level = RF input level - RF ATT setting level

• Option 10: Centronics interface

Function	Outputs data to printer (Centronics standard). GPIB interface cannot be installed simultaneously.
Connector	D-sub 25-pin (jack)

• **Option 12: QP detector (MS2661B only)**

Functions	QP detection *Requires Option 02. When Option 12 installed, Option 02 RBW 100 Hz 3 dB bandwidth changed to 150 Hz (typical)																																							
6 dB bandwidth	200 Hz, 9 kHz, 120 kHz Accuracy: $\pm 30\%$ (18° to 28°C)																																							
Display	LOG scale, 5 dB/div (10 divisions) Linearity: $\leq \pm 2.0$ dB (0 to -40 dB, CW signal, reference level: 60 dB μ V, RF ATT: 0 dB, 18° to 28°C)																																							
Pulse response characteristics	Response to CISPR pulse (DET mode: QP, 18° to 28°C)																																							
	<table border="1"> <thead> <tr> <th rowspan="2">Repetition frequency</th> <th colspan="3">Bandwidth</th> </tr> <tr> <th>120 kHz</th> <th>9 kHz</th> <th>200 Hz</th> </tr> </thead> <tbody> <tr> <td>1 kHz</td> <td>$\leq -8.0 \pm 1.0$ dB</td> <td>$\leq -4.5 \pm 1.0$ dB</td> <td>-</td> </tr> <tr> <td>100 Hz</td> <td>Referenced</td> <td>Referenced</td> <td>$\leq -4.0 \pm 1.0$ dB</td> </tr> <tr> <td>60 Hz</td> <td>-</td> <td>-</td> <td>$\leq -3.0 \pm 1.0$ dB</td> </tr> <tr> <td>25 Hz</td> <td>-</td> <td>-</td> <td>Referenced</td> </tr> <tr> <td>20 Hz</td> <td>$\leq +9.0 \pm 1.0$ dB</td> <td>$\leq +6.5 \pm 1.0$ dB</td> <td>-</td> </tr> <tr> <td>10 Hz</td> <td>$\leq +14.0 \pm 1.5$ dB</td> <td>$\leq +10.0 \pm 1.5$ dB</td> <td>$\leq +4.0 \pm 1.0$ dB</td> </tr> <tr> <td>2 Hz</td> <td>$\leq +26.0 \pm 2.0$ dB</td> <td>$\leq +20.5 \pm 2.0$ dB</td> <td>$\leq +13.0 \pm 2.0$ dB</td> </tr> <tr> <td>1 Hz</td> <td>$\leq +28.5 \pm 2.0$ dB</td> <td>$\leq +22.5 \pm 2.0$ dB</td> <td>$\leq +17.0 \pm 2.0$ dB</td> </tr> </tbody> </table>	Repetition frequency	Bandwidth			120 kHz	9 kHz	200 Hz	1 kHz	$\leq -8.0 \pm 1.0$ dB	$\leq -4.5 \pm 1.0$ dB	-	100 Hz	Referenced	Referenced	$\leq -4.0 \pm 1.0$ dB	60 Hz	-	-	$\leq -3.0 \pm 1.0$ dB	25 Hz	-	-	Referenced	20 Hz	$\leq +9.0 \pm 1.0$ dB	$\leq +6.5 \pm 1.0$ dB	-	10 Hz	$\leq +14.0 \pm 1.5$ dB	$\leq +10.0 \pm 1.5$ dB	$\leq +4.0 \pm 1.0$ dB	2 Hz	$\leq +26.0 \pm 2.0$ dB	$\leq +20.5 \pm 2.0$ dB	$\leq +13.0 \pm 2.0$ dB	1 Hz	$\leq +28.5 \pm 2.0$ dB	$\leq +22.5 \pm 2.0$ dB	$\leq +17.0 \pm 2.0$ dB
	Repetition frequency		Bandwidth																																					
		120 kHz	9 kHz	200 Hz																																				
	1 kHz	$\leq -8.0 \pm 1.0$ dB	$\leq -4.5 \pm 1.0$ dB	-																																				
	100 Hz	Referenced	Referenced	$\leq -4.0 \pm 1.0$ dB																																				
	60 Hz	-	-	$\leq -3.0 \pm 1.0$ dB																																				
	25 Hz	-	-	Referenced																																				
	20 Hz	$\leq +9.0 \pm 1.0$ dB	$\leq +6.5 \pm 1.0$ dB	-																																				
10 Hz	$\leq +14.0 \pm 1.5$ dB	$\leq +10.0 \pm 1.5$ dB	$\leq +4.0 \pm 1.0$ dB																																					
2 Hz	$\leq +26.0 \pm 2.0$ dB	$\leq +20.5 \pm 2.0$ dB	$\leq +13.0 \pm 2.0$ dB																																					
1 Hz	$\leq +28.5 \pm 2.0$ dB	$\leq +22.5 \pm 2.0$ dB	$\leq +17.0 \pm 2.0$ dB																																					
QP on/off switching uncertainty (PEAK, QP)	$\leq \pm 1.0$ dB (CW signal, reference level - 40 dB, after auto-calibration, 18° to 28°C)																																							
Detection mode	QP, AVERAGE																																							
Field strength measurement	Waveform data compensation data display for specified antenna factor, field strength (dB μ V/m) Built-in antenna factors: MP534A/651A Dipole Antenna, MP635A/666A Log-Periodic Antenna, MP414B Loop Antenna, user-defined (four types writable via GPIB or RS-232C, can be saved/loaded to/from memory card)																																							

• **Option 13: QP detector (MS2651B only)**

6 dB bandwidth	9 kHz, 120 kHz Accuracy: $\pm 30\%$ (18° to 28°C)																							
Display	LOG scale, 5 dB/div (10 divisions) Linearity: $\leq \pm 2.0$ dB (0 to -40 dB, CW signal, reference level: 60 dB μ V, RF ATT: 0 dB, 18° to 28°C)																							
Pulse response characteristics	Response to CISPR pulse (DET mode: QP, 18° to 28°C)																							
	<table border="1"> <thead> <tr> <th rowspan="2">Repetition frequency</th> <th colspan="2">Bandwidth</th> </tr> <tr> <th>120 kHz</th> <th>9 kHz</th> </tr> </thead> <tbody> <tr> <td>1 kHz</td> <td>$\leq -8.0 \pm 1.0$ dB</td> <td>$\leq -4.5 \pm 1.0$ dB</td> </tr> <tr> <td>100 Hz</td> <td>Referenced</td> <td>Referenced</td> </tr> <tr> <td>20 Hz</td> <td>$\leq +9.0 \pm 1.0$ dB</td> <td>$\leq +6.5 \pm 1.0$ dB</td> </tr> <tr> <td>10 Hz</td> <td>$\leq +14.0 \pm 1.5$ dB</td> <td>$\leq +10.0 \pm 1.5$ dB</td> </tr> <tr> <td>2 Hz</td> <td>$\leq +26.0 \pm 2.0$ dB</td> <td>$\leq +20.5 \pm 2.0$ dB</td> </tr> <tr> <td>1 Hz</td> <td>$\leq +28.5 \pm 2.0$ dB</td> <td>$\leq +22.5 \pm 2.0$ dB</td> </tr> </tbody> </table>	Repetition frequency	Bandwidth		120 kHz	9 kHz	1 kHz	$\leq -8.0 \pm 1.0$ dB	$\leq -4.5 \pm 1.0$ dB	100 Hz	Referenced	Referenced	20 Hz	$\leq +9.0 \pm 1.0$ dB	$\leq +6.5 \pm 1.0$ dB	10 Hz	$\leq +14.0 \pm 1.5$ dB	$\leq +10.0 \pm 1.5$ dB	2 Hz	$\leq +26.0 \pm 2.0$ dB	$\leq +20.5 \pm 2.0$ dB	1 Hz	$\leq +28.5 \pm 2.0$ dB	$\leq +22.5 \pm 2.0$ dB
	Repetition frequency		Bandwidth																					
		120 kHz	9 kHz																					
	1 kHz	$\leq -8.0 \pm 1.0$ dB	$\leq -4.5 \pm 1.0$ dB																					
	100 Hz	Referenced	Referenced																					
	20 Hz	$\leq +9.0 \pm 1.0$ dB	$\leq +6.5 \pm 1.0$ dB																					
	10 Hz	$\leq +14.0 \pm 1.5$ dB	$\leq +10.0 \pm 1.5$ dB																					
2 Hz	$\leq +26.0 \pm 2.0$ dB	$\leq +20.5 \pm 2.0$ dB																						
1 Hz	$\leq +28.5 \pm 2.0$ dB	$\leq +22.5 \pm 2.0$ dB																						
QP on/off switching uncertainty (PEAK, QP)	$\leq \pm 1.0$ dB (CW signal, reference level - 40 dB, after auto-calibration, 18° to 28°C)																							
Detection mode	QP, AVERAGE																							
Field strength measurement	Waveform data compensation data display for specified antenna factor, field strength (dB μ V/m) Built-in antenna factors: MP534A/651A Dipole Antenna, MP635A/666A Log-Periodic Antenna, MP414B Loop Antenna, user-defined (four types writable via GPIB or RS-232C, can be saved/loaded to/from memory card)																							

• **Option 14: PTA parallel I/O**

Functions	Controls external devices from PTA, cannot be installed when Option 10 installed
System variables	As follows using PTA system variables IOA: Controls 8-bit parallel output port A IOD: Controls 4-bit parallel input/output port D IOB: Controls 8-bit parallel output port B EIO: Controls I/O switching of ports C/D IOC: Controls 4-bit parallel input/output port C EXO: Controls I/O trigger
PTL statements	External interrupt control of input to I/O ports using PTA-PTL statements IOEN statement: Enables interrupt input ON TO GOTO statement: Changes program flow at interrupt generation IODI statement: Disables interrupt input ON TO GOSUB statement: Changes program flow at interrupt generation IOMA statement: Masks interrupt input
Write strobe signal	Write strobe signal (negative pulse) output externally at control of output ports C/D
Power supply	External +5 \pm 0.5 Vdc (max. 100 mA) supply
Signal logic levels	Negative logic, TTL level Specified current: Output ports A/B (max. output current Hi: 2.6 mA, Lo: 24 mA) Output ports C/D (max. output current Hi: 15 mA, Lo: 24 mA) Other control output lines (max. output current Hi: 0.4 mA, Lo: 8 mA)

Continued on next page

Connection cable connectors	Amphenol 36 pins					
Connector pin layout	No.	Item	No.	Item	No.	Item
	1	GND	13	Output port B (0) LSB	25	I/O port D (0) LSB
	2	Trigger input	14	Output port B (1)	26	I/O port D (1)
	3	Trigger output 1	15	Output port B (2)	27	I/O port D (2)
	4	Trigger output 2	16	Output port B (3)	28	I/O port D (3) MSB
	5	Output port A (0) LSB	17	Output port B (4)	29	Port C status 0/1: I/O
	6	Output port A (1)	18	Output port B (5)	30	Port D status 0/1: I/O
	7	Output port A (2)	19	Output port B (6)	31	Write strobe signal
	8	Output port A (3)	20	Output port B (7) MSB	32	Interruption signal
	9	Output port A (4)	21	I/O port C (0) LSB	33	Not used
	10	Output port A (5)	22	I/O port C (1)	34	+5 V power supply
	11	Output port A (6)	23	I/O port C (2)	35	Not used
	12	Output port A (7) MSB	24	I/O port C (3) MSB	36	Not used

• **Option 15: Sweep signal output**

Sweep output (X)	0 to 10 V ± 1 V (≥ 100 k Ω termination, from left side to right side of display scale), BNC connector
Sweep status output (Z)	TTL level (low level with sweeping), BNC connector

• **Option 19: DC coupled input (MS2661B only)**

Functions	DC-couples input circuit of main unit and expands lower limit of receiver frequency range to 500 Hz *Can only be installed with narrow RBW (Option 02)
Electrical characteristics	The standard specifications of the main unit are supplemented and changed as follows: Frequency range: 500 Hz to 3.0 GHz Max. input level: +30 dBm (CW, RF ATT: ≥ 10 dB), ± 0 Vdc Average noise level: ≤ 80 dBm (500 Hz to 10 kHz), ≤ 90 dBm (10 kHz to 200 kHz), ≤ -110 dBm (200 kHz to 1 MHz) *RBW: 30 Hz, VBW: 1 Hz, RF ATT: 0 dB Frequency response: ± 1.2 dB (500 Hz to 100 kHz), ± 0.5 dB (100 kHz to 3 GHz) *Referenced to 100 MHz frequency, RF ATT: 10 dB, 18° to 28°C

• **Option 20: Tracking generator**

Frequency range	9 kHz to 3 GHz
Output level range	0 to -60 dBm
Setting resolution	0.1 dB
Output level accuracy	$\leq \pm 1.0$ dB (at 100 MHz, 0 dBm)
Output level flatness	$\leq \pm 1.5$ dB (100 kHz to 3 GHz, output level: 0 dBm, referenced to 100 MHz frequency)
Output level linearity	$\leq \pm 1.0$ dB (0 to -30 dBm), $\leq \pm 2.0$ (-30 to -60 dBm) *100 kHz to 3 GHz, 0 dBm output level reference
Spurious	Harmonic: ≤ -20 dBc (100 kHz to 3 GHz), Non-harmonic: ≤ -35 dBc (100 kHz to 3 GHz)
Tracking generator feed through	≤ -95 dBm (spectrum analyzer input and tracking generator output connectors terminated at 50 Ω)
Output connector	N-J, 50 Ω

• **Option 21: Television monitor (Multi)**

Video	M-NTSC, B/G/H/I/D PAL, color
Audio	Simultaneous monitoring of video and audio *Needs Option 07
Functions	Channel: Automatic setting to broadcast wave of CCIR, Japan, USA, Italy, UK and China; automatic setting to CATV of CCIR, Japan, and USA Trigger: Triggered sweep by V-SYNC, H-SYNC *Needs trigger/gate circuit (Option 06) Aux. output: Composite video signal, Connector: BNC

• **Option 22: 75 Ω input (Option 12, 13, 19, and 20 cannot be installed simultaneously)**

Frequency range	100 kHz to 2.5 GHz
Amplitude	Level measurement Measurement range: Average noise level to +25 dBm (+133.8 dBμV) Max. input level: +25 dBm (+133.8 dBμV, CW average power, RF ATT: ≥10 dB), ±100 Vdc Residual response: ≤-95 dBm (+13.8 dBμV, RF ATT: 0 dB, input: 75 Ω terminated, 1 MHz to 2.5 GHz)
	Total level accuracy ±1.8 dB (100 kHz to 2.5 GHz, level measurement accuracy after calibration using internal calibration signal) Total level accuracy: Reference level accuracy (0 to -49.9 dBm) + frequency response + log linearity (0 to -20 dBm) + calibration signal source accuracy
	Reference level Setting range Log scale: +8.8 to +133.8 dBμV, Linear scale: 274 μV to 4.87 V
	Frequency response ±1.0 dB (100 kHz to 2.5 GHz, referenced to 100 MHz, RF ATT: 10 dB, 18° to 28°C)
	Waveform display Linearity (after calibration) Log scale: ±0.4 dB (0 to -20 dB, RBW: ≤1 MHz), ±1.0 dB (0 to -70 dB, RBW: ≤100 kHz), ±1.5 dB (0 to -85 dB, RBW: ≤3 kHz) Linear scale: ±4% (according to reference level) Marker level resolution Log scale: 0.01 dB Linear scale: 0.02% (according to reference level)
Spurious response	2nd harmonic distortion (MS2651B): ≤-55 dBc (10 to 100 MHz, mixer input: -30 dBm), ≤-60 dBc (0.1 to 1.25 GHz, mixer input: -30 dBm) 2nd harmonic distortion (MS2661B): ≤-60 dBc (10 to 200 MHz, mixer input: -30 dBm), ≤-75 dBc (0.2 to 1.25 GHz, band 0, mixer input: -30 dBm), ≤-80 dBc (0.8 to 1 GHz, mixer input: -30 dBm) Two signals 3rd order intermodulation distortion (MS2651B): ≤-70 dBc (10 to 2.5 GHz) *Frequency difference of two signals: ≥50 kHz, mixer input: -30 dBm Two signals 3rd order intermodulation distortion (MS2661B): ≤-70 dBc (10 to 100 MHz), ≤-80 dBc (0.1 to 2.5 GHz) *Frequency difference of two signals: ≥50 kHz, mixer input: -30 dBm
	Max. dynamic range 1 dB gain compression level to average noise level (MS2651B): >105 dB (0.1 to 1 GHz), >105 dB - f [GHz] dB (>1 GHz) 1 dB gain compression level to average noise level (MS2661B): >110 dB (0.1 to 1 GHz), >110 dB - f [GHz] dB (>1 GHz), >109 dB (0.1 to 1 GHz, with Option 08), >109 dB - 1.5f [GHz] dB (>1 GHz with Option 08) Distortion characteristics (MS2651B RBW: 1 kHz) 2nd harmonic: >67.5 dB (10 to 100 MHz), >70 dB (100 to 500 MHz), >70 - f [GHz] dB (0.5 to 1.25 GHz) 3rd order intermodulation: >76.6 dB (0.1 to 1 GHz), >76.6 dB - (2/3)f [GHz] dB (1 to 2.5 GHz) Distortion characteristics (MS2661B RBW: 1 kHz) 2nd harmonic: >72.5 dB (10 to 200 MHz), >80 dB (200 to 500 MHz), >80 - f [GHz] dB (0.5 to 1.25 GHz), >82.5 - f [GHz] dB (0.8 to 1 GHz) 3rd order intermodulation: >80 dB (10 to 100 MHz), >83.3 dB (0.1 to 1 GHz), >83.3 dB - (2/3)f [GHz] dB (1 to 2.5 GHz)
Functions	Input connector NC-J, 75 Ω
	Auxiliary I/O VIDEO OUTPUT (Y): 0 to 0.5 V ±0.1 V (typical, from lower edge to upper edge at 10 dB/div, 100 MHz, 75 Ω terminated) 0 to 0.4 V ±0.1 V (typical, from lower edge to upper edge at 10%/div, 100 MHz, 75 Ω terminated), BNC connector

• **Option 23: 75 Ω tracking generator (Option 12, 13, 19, and 20 cannot be installed simultaneously)**

Frequency range	100 kHz to 2.5 GHz
Output level range	+44 to +104 dBμV (setting resolution: 0.1 dB)
Output level accuracy	≤±1.5 dB (100 MHz, output level: +104 dBμV)
Output level flatness	≤±1.75 dB (100 kHz to 2.5 GHz, output level: +104 dBμV, referenced to 100 MHz)
Output level linearity	≤±1.0 dB (+74 to +104 dBμV), ≤±2.0 dB (+44 to +74 dBμV) *100 kHz to 2.5 GHz, referenced to +104 dBμV
Spurious	Harmonics: ≤-20 dBc (100 kHz to 2.5 GHz) Non-harmonics: ≤-30 dBc (100 kHz to 2.5 GHz)
Tracking generator feed through	≤13.8 dBμV (spectrum analyzer input and tracking generator output connectors terminated at 75 Ω)
Output connector	NC-J, 75 Ω

• **Option 24: Television monitor (Brazil)**

Video	M-NTSC, M PAL, color
Audio	Simultaneous monitoring of video and audio *Needs Option 07
Functions	Channel: Automatic setting to broadcast wave of CCIR, Japan and USA; automatic setting to CATV of CCIR, Japan and USA Trigger: Triggered sweep by V-SYNC, H-SYNC *Needs trigger/gate circuit (Option 06) Aux. output: Composite video signal, Connector: BNC

Ordering information

Please specify model/order number, name, and quantity when ordering.

Model/order No.	Name	Model/order No.	Name
MS2651B	Main frame Spectrum Analyzer	J0076	Coaxial adapter (NC-P · F-J)
MS2661B	Spectrum Analyzer	B0391A	Carrying case (hard type, with casters)
	Standard accessories	B0391B	Carrying case (hard type, without casters)
	Power cord, 2.6 m: 1 pc	B0436A	Carrying case (soft type)
F0013	Fuse, 5 A: 2 pcs	MP612A	RF Fuse Holder
W1251AE	MS2650B, MS2660B/C series operation manual: 1 copy	MP613A	Fuse Element
B0329G	Front cover(3/4MW4U)	J0805	DC Block (Model 7003, 10 kHz to 18 GHz, ±50 V, Weinschel product)
	Options	MA2507A	DC Block Adapter (50 Ω, 9 kHz to 3 GHz, ±50 V)
MS2651B/2661B-01	Reference crystal oscillator	MA8601A	DC Block Adapter (50 Ω, 30 kHz to 2 GHz, ±50 V)
MS2661B-02	Narrow resolution bandwidth	MA8601J	DC Block Adapter (75 Ω, 10 kHz to 2.2 GHz, ±50 V)
MS2651B/2661B-04	High-speed time domain sweep	MA1621A	50 Ω → 75 Ω Impedance Transformer (9 kHz to 3 GHz, ±100 V)
MS2651B/2661B-06	Trigger/gate circuit		50 Ω ↔ 75 Ω Impedance Transformer
MS2651B/2661B-07	AM/FM demodulator	MP614A	50 Ω ↔ 75 Ω Impedance Transformer
MS2651B/2661B-08	Pre-amplifier	J0121	Coaxial cord (NC-P-3W · 3C-2WS · NC-P-3W), 1 m
MS2651B/2661B-10	Centronics interface (GPIB cannot be installed simultaneously)	J0308	Coaxial cord (BNC-P · 3C-2WS · NC-P-3W), 1 m
MS2661B-12	QP detector (requires Option 02, QP-BW: 0.2/9/120 kHz)	J0063	Fixed attenuator for high power (30 dB, 10 W, DC to 12.4 GHz)
MS2651B-13	QP detector (QP-BW: 9/120 kHz)	J0395	Fixed attenuator for high power (30 dB, 30 W, DC to 9 GHz)
MS2651B/2661B-14	PTA parallel I/O (Option 10 cannot be installed simultaneously)	MP640A	Branch
MS2651B/2661B-15	Sweep signal output	MP654A	Branch
MS2661B-19	DC coupled input (MS2661B only, requires Option 02)	MP520A	CM Directional Coupler
MS2651B/2661B-20	Tracking generator	MP520B	CM Directional Coupler
MS2651B/2661B-21	Television monitor (Multi)	MP520C	CM Directional Coupler
MS2651B/2661B-22	75 Ω input (Option 12, 13, 19, and 20 cannot be installed simultaneously)	MP520D	CM Directional Coupler
MS2651B/2661B-23	75 Ω tracking generator (Option 12, 13, 19, and 20 cannot be installed simultaneously)	MP526A	High Pass Filter
MS2651B/2661B-24	Television monitor (Brazil)	MP526B	High Pass Filter
	Application parts	MP526C	High Pass Filter
MX260002A	CDMA Cellular System Measurement Software	MP526D	High Pass Filter
MX260003A	PDC Measurement Software (for base station)	MP526G	High Pass Filter
MX260004A	GSM Measurement Software	MA1601A	High Pass Filter (800/900 MHz band, N)
MX261001A	Low-Power Data Communication System Measurement Software conforming to issue of Direct Spread Spectrum System	J0007	GPIB cable, 1 m
MX261002A	Low-Power Data Communication System Measurement Software conforming to issue of Frequency Hopping System	J0008	GPIB cable, 2 m
MX262001A	CATV Measurement Software	J0742A	RS-232C cable, 1 m [for PC-98 Personal Computer and VP-600, D-sub 25 pins (straight)]
MX264001A	EMI Measurement Software	J0743A	RS-232C cable, 1 m [for AT compatible, D-sub 9-pins (cross)]
J0561	Coaxial cord (N-P-5W · 5D-2W · N-P-5W), 1 m	60N50-1	Reflection bridge
J0104A	Coaxial cord (BNC-P · RG-55/U · N-P), 1 m	60NF50-1	Reflection bridge
CSCJ-256K-SM	256 KB memory card (meets PCMCIA Rel. 2.0)	87A50	Reflection bridge
CSCJ-512K-SM	512 KB memory card (meets PCMCIA Rel. 2.0)	62N75	Reflection bridge
CSCJ-001M-SM	1024 KB memory card (meets PCMCIA Rel. 2.0)	62NF75	Reflection bridge
CSCJ-002M-SM	2048 KB memory card (meets PCMCIA Rel. 2.0)	MH648A	Pre-Amplifier
B0395A	Rack mount kit (IEC)	MP534A	Dipole Antenna
B0395B	Rack mount kit (JIS)	MP651A	Dipole Antenna
J0055	Coaxial adapter (NC-P · BNC-J)	BBA9106/VHA9103	Biconical Antenna
		MP635A	Log-Periodic Antenna
		MP666A	Log-Periodic Antenna
		MB9A	Tripod
		MB19A	Tripod
		MA2601B	EMI Probe
		MA2601C	EMI Probe
		KT-10	EMI Clamp
		KT-20	EMI Clamp

PRE-AMPLIFIER
MH648A
100 kHz to 1200 MHz

The MH648A is a pre-amplifier for improving sensitivity in spectrum analyzers, field strength meters, frequency counters, etc.

For Amplifying Low-Level Signals



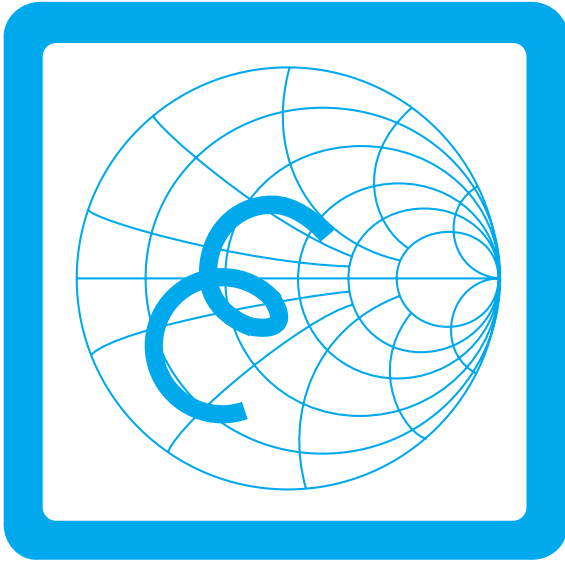

NETWORK ANALYZERS

Vector Network Measurement Systems	350
Vector Network Measurement	
System/Direct-Access Receiver	356
Power Amplifier Test System (PATS)	358
Vector Network Analyzers	360
Millimeter Wave Vector Network Analyzer	365
Broadband Vector Network Analyzer	368
Vector Network Analyzer Automatic Calibrator	370
VNA and VNMS Calibration Kits	372
VNA and VNMS Verification Kits	374
Network Analyzers	375, 381
Millimeter Wave Measurement System	379
Scalar Network Analyzer	386
Reflection Bridges	386
Transformers	386

VECTOR NETWORK MEASUREMENT SYSTEMS

MS4622A/B, MS4623A/B

10 MHz to 3 GHz

10 MHz to 6 GHz

Innovative Manufacturing Solutions for Measuring S-Parameters, NF, P_{1dB}, IMD, and 3-Port Devices

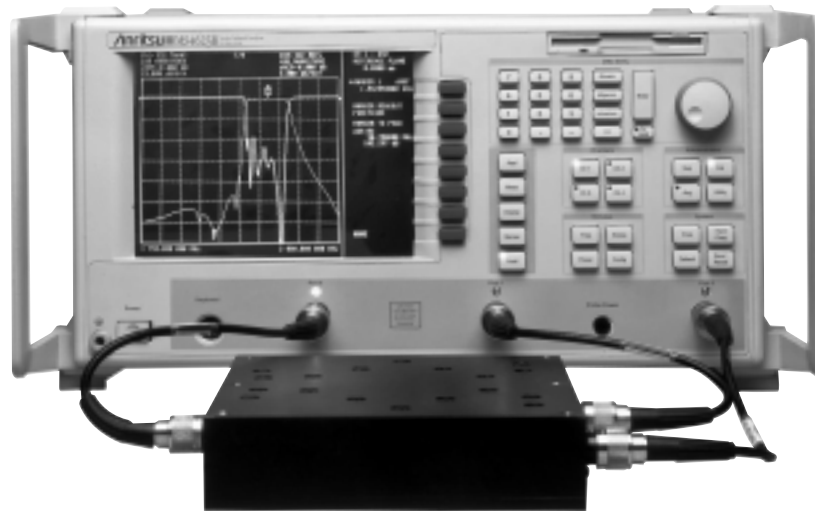

GPIB

Anritsu has a new family of RF Vector Network Measurement Systems, the MS462XA and MS462XB. Code named Scorpion®, the MS462XX line is much more capable than traditional VNAs. With Scorpion's all new measurement options of vector error-corrected Noise Figure, Intermodulation Distortion, Third Measurement Port, and Harmonics, they create a total test solution. And, when you add the standard benefits of outstanding dynamic range and blazing fast measurement speed, you have a truly innovative solution for a manufacturing test environment! Scorpion's optional AutoCal® feature also provides a capability for achieving fast, accurate, and highly repeatable calibrations without the need for an external controller. By using AutoCal® standard connector types or test port cable converters, you can calibrate directly using Type N, K, 3.5 mm, or SMA connectors. Planned upgrades include adapter characterization with the ability to calibrate using 7/16 or TNC type connectors.

Performance

- **Measurement speed**

With point-to-point, fully phase-locked, fully error-corrected sweep speeds as fast as 150 μ sec per point, Scorpion® provides the real-time measurement speed required for your production line. Its Tune Mode feature offers the advantage of maintaining a full 12-term calibration while simultaneously optimizing sweep speed for the S-parameter measurements of interest.

- **Dynamic range**

The MS462XX family provides system dynamic range of up to 125 dB. This dynamic range, coupled with an impressive measurement speed, lets you tune 2- or 3-port devices with nulls as low as 100 dB in real time.

- **Test sequencing / keyboard control**

For ease in automating repetitive set-ups, calibrations, measurements, or other functions, Scorpion® implements a Test Sequencing (Macro) capability. It can internally store up to seven different sequences and run them directly from either the front panel or an external AT-style keyboard. You can use the supplied keyboard-function-key overlay to fully operate the unit without touching its front panel.

- **3-Port measurements**

Improve and simplify calibrations and measurements of 3-port devices by adding the optional third measurement port. The Scorpion® family is capable of fully calibrating 3-port measurement setups. This maximizes the accuracy of 3-port measurements without the need for making time-consuming and error-inducing connector disconnects and reconnects.

- **Second internal source with third measurement port**

Fully characterize any device that requires two independent sources. Also the testing of passive 3-port devices such as duplexers, circulators/isolators, and mixers – as well as two-tone intermodulation testing of active devices – is greatly simplified using this option.

- **Pass/fail testing**

Evaluate test data using single and segmented limit lines. Create upper and lower trace boundaries of go/no-go testing.

- **Marker functions**

Use up to 12 independent markers to collect data at points of interest, to set boundaries for a marker sweep, or to automatically calculate characteristics such as 3 dB bandwidth, shape factor, and Q.

Performance and functions

• Vector error-corrected noise figure measurements

The MS4622B and MS4623B Vector Network Measurement Systems deliver the industry's first ever capability for making vector error-corrected noise figure measurements on active devices in today's hottest market – wireless communications. The Noise Figure options, 4 and 4B, covering the frequency ranges of 50 MHz to 3 GHz and 50 MHz to 6 GHz respectively, give you the functionality for making noise figure measurements much more accurately than has ever before been possible. This option allows for making S-parameter measurements and noise figure measurements with a single test connection. The measurement setup can be configured to make measurements with the noise source set in either an internal or an external mode. In the external mode, the noise source is connected directly to the DUT similar to traditional scalar noise figure measurements. In the internal mode, the noise source is connected to the VNA rear panel and internally routed to port 1. Therefore, when a 12-term calibration is applied concurrently with the noise figure calibration, you can make vector error-corrected noise figure measurements.



• AutoCal®

One source of potential errors and inaccuracies in any measurement system is its calibration. A great deal of time can be wasted in a busy manufacturing environment trying to verify calibration accuracy, especially when multiple shifts run on several different test stations for the same product line. For this situation, you need a calibration system in place that offers the highest possible degree of assurance that every station on every shift is calibrated for identical results. With the Anritsu AutoCal® automatic calibrator, you get just that. Simply connect a serial cable between the AutoCal® and the rear panel of the VNA and you're ready to go. If adapters become necessary, AutoCal® can handle them with its revolutionary approach to adapter removal. This approach avoids the necessity of multiple calibrations commonly used in adapter removal calibrations. By using the AutoCal® adapter characterization process, you can calibrate in a SMA, Type N, 3.5mm, TNC, or 7/16 environment with confidence.



• Built-in third measurement port and second internal source

Some of today's most demanding VNA measurements involve the characterization and tuning of multiple port devices such as duplexers, combiners, couplers, etc. In a traditional 2-port VNA, the full characterization and tuning of such devices presents significant challenges in terms of measurement speed, calibration, and the switching of input signals and measurement ports. With the addition of the third measurement port, the simplicity and speed with which these devices can be tested is greatly enhanced. The MS4622B and MS4623B network analyzers not only offer the option of adding a third measurement port, they also offer the industry's first ever second internal source. This second source is completely independent from the main source that switches between ports 1 and 2. By the addition of this second source, the potential now exists for replacing the signal generators and spectrum analyzers currently needed to characterize the non-linear effects that occur when multiple tones are simultaneously present in the pass-band of an active device.



• Mixer measurements

Scorpion can also accurately characterize your mixers and other frequency-translating devices (FTDs) for isolation, match, conversion loss, noise figure and frequency translated group delay (FTGD). Without changing cables or instruments, Scorpion can make all these measurements quickly, easily and accurately. Add an external synthesizer and Scorpion can easily orchestrate swept frequency and swept power mixer IMD measurements. You no longer have to buy and integrate five separate instruments to perform these everyday measurements. With the integrated measurement flexibility of Scorpion, you can design and manufacture all of your passive, active, and frequency translating devices using a single instrument.



Specifications

Test port characteristics	Standard connector type	N female				
	Optional connector types	3.5 mm female, 3.5 mm male, GPC-7, N male				
	Measurement port characteristics	Connector	Frequency (MHz)	Directivity (dB)	Source match (dB)	Load match (dB)
		3.5 mm	10 to 1000 ^{*1,2}	>46	>44	>46
			1000 to 3000 ^{*1,2}	>44	>41	>44
			3000 to 6000 ^{*1,2}	>38	>39	>38
		3.5 mm	10 to 1000 ^{*1,3}	>44	>42	>44
			1000 to 3000 ^{*1,3}	>42	>40	>42
			3000 to 6000 ^{*1,3}	>37	>37	>37
		3.5 mm	10 to 1000 ^{*4}	>30	>15	>15
1000 to 3000 ^{*4}			>25	>15	>15	
3000 to 6000 ^{*4}	>20		>15	>15		
N-Type	10 to 1000 ^{*1,2}	>46	>44	>46		
	1000 to 3000 ^{*1,2}	>44	>41	>44		
	3000 to 6000 ^{*1,2}	>38	>39	>38		
N-Type	10 to 1000 ^{*1,3}	>44	>42	>44		
	1000 to 3000 ^{*1,3}	>42	>40	>42		
	3000 to 6000 ^{*1,3}	>37	>37	>37		
N-Type	10 to 1000 ^{*4}	>30	>15	>15		
	1000 to 3000 ^{*4}	>25	>15	>15		
	3000 to 6000 ^{*4}	>20	>15	>15		
GPC-7	10 to 1000 ^{*1,2}	>46	>44	>46		
	1000 to 3000 ^{*1,2}	>44	>41	>44		
	3000 to 6000 ^{*1,2}	>38	>39	>38		
GPC-7	10 to 1000 ^{*1,3}	>44	>42	>44		
	1000 to 3000 ^{*1,3}	>42	>40	>42		
	3000 to 6000 ^{*1,3}	>37	>37	>37		
GPC-7	10 to 1000 ^{*4}	>30	>15	>15		
	1000 to 3000 ^{*4}	>25	>15	>15		
	3000 to 6000 ^{*4}	>20	>15	>15		
Source specifications	Frequency range	MS4622A/B, 10 MHz to 3 GHz MS4623A/B, 10 MHz to 6 GHz				
	Frequency resolution	1Hz				
	Frequency stability (with internal time base) – aging	<5x10 ⁻⁶ / year				
	Temperature	<5x10 ⁻⁶ over +15°C to +50°C				
	Power output range	MS4622A Transmission/Reflection Test Set	+10 to –85 dBm			
		MS4622B Active Reversing Test Set	+10 to –85 dBm			
		MS4622B (Opt 3) w/ 2nd Source, 3rd Test Port & S/A.	+10 to –85 dBm			
		MS4622B (Opt 4) w/ Noise Figure	+7 to –85 dBm			
		MS4622B (Opt 6) w/ 3rd Test Port	+10 to –85 dBm			
		MS4623A Transmission/Reflection Test Set	+10 to –85 dBm			
		MS4623B Active Reversing Test Set	+7 to –85 dBm			
		MS4623B (Opt 3) w/ 2nd Source, 3rd Test Port & S/A	+7 to –85 dBm			
		MS4623B (Opt 4) w/ Noise Figure (3 GHz only)	+5 to –85 dBm			
	MS4623B (Opt 6) w/ 3rd Test Port	+7 to –85 dBm				
	Power control range	≥ 20 dB. The minimum absolute level for power sweep is –15 dBm while the maximum power output for a unit is +10 dBm.				
	Source power level	The source power (dBm) may be set from the front panel menu or via GPIB. Port 1 power level is settable from +10 dBm (on the simpler test sets, ranging to +5 dBm on the most complex) to –15 dBm with 0.01 dB resolution. In addition, the port 1 (& port 3) power may be attenuated in 10 dB steps using the internal 70 dB step attenuator.				
	Power level accuracy	±1 dB (no flat power calibration applied; full-band frequency sweep at –15 dBm, 0 dBm, and maximum rated power)				
	Level test port power	The power at all sweep frequencies is leveled to within ±1dB. Only port 1 and port 3 (if installed) can be externally leveled.				
	Harmonics and spurious	<–30 dBc at maximum rated power				
Sweep type	Linear, CW, Marker, or N-Discrete point sweep					
Power sweep range	20 dB (minimum)					
Source #2 (optional)	Frequency range	10 MHz to 3 GHz (6 GHz)				
	Frequency resolution	1 Hz				
	Power level accuracy	±1 dB (no flat power calibration applied; full-band frequency sweep at –15 dBm, 0 dBm & max rated power)				
	Harmonics and spurious	<–30 dBc at maximum rated power (not applicable in harmonic measurement mode)				
	Sweep type	Linear, CW, Marker, or N-Discrete point sweep				
Power sweep range	20 dB (minimum)					

*1: 12-term error correction applied

*2: Port 1 & Port 2

*3: Optional Port 3 added

*4: Uncorrected performance

Continued on next page

Receiver specs	Average noise level	-100 dBm in 10 Hz IF Bandwidth (< 3 GHz); Typically > -110 dBm in narrowband sweep -90 dBm in 10 Hz IF Bandwidth (> 3 GHz); Typically > -100 dBm in narrowband sweep			
	Maximum input level	+27 dBm, +20 dBm noise figure mode			
	Damage level	> +30 dBm, > +23 dBm noise figure mode			
Measurement speed summary	Measurement times are measured using a single trace (S ₂₁) display and one average. The measurement speeds for the communications band are measured in a 25 MHz band from 824 – 849 MHz. The typical measurement times displayed are as follows:				
	Data points	IF bandwidth (Hz)	10 MHz to 3 GHz (ms)	10 MHz to 6 GHz (ms)	Communications band (ms)
	51	30 kHz	22	25	13
		10 kHz	27	31	18
		3 kHz	38	41	28
		1 kHz	71	75	62
		300 Hz	190	194	181
	101	30 kHz	32	36	21
10 kHz		41	45	29	
3 kHz		63	67	51	
1 kHz		130	135	118	
300 Hz		366	371	355	
201	30 kHz	49	54	37	
	10 kHz	68	74	52	
	3 kHz	112	118	96	
	1 kHz	247	253	231	
	300 Hz	717	723	701	
401	30 kHz	85	92	69	
	10 kHz	122	130	97	
	3 kHz	212	220	186	
	1 kHz	481	489	456	
	300 Hz	1418	1426	1393	
801	30 kHz	154	166	132	
	10 kHz	230	242	190	
	3 kHz	408	420	367	
	1 kHz	947	959	907	
	300 Hz	2819	2831	2777	
Measurement capabilities	Parameters	S ₁₁ , S ₂₁ , S ₂₂ , S ₁₂ , S ₃₃ , S ₂₃ , S ₃₂ , S ₁₃ , S ₃₁ , Harmonics, Noise Figure, Intermodulation Distortion (IMD), and user-defined combinations of a ₁ , a ₂ , a ₃ , b ₁ , b ₂ , and b ₃ .			
	Measurement frequency range	Frequency range of measurement can be narrowed within the calibration range without recalibration. CW mode permits single frequency measurements, also without recalibration. In addition, the system accepts N discrete frequency points where 2 < N < 1601.			
	Domains	Frequency Domain, CW Draw, and optional High Speed Time (Distance) Domain			
	Formats	Log Magnitude, Phase, Log Magnitude & Phase, Smith Chart (Impedance), Smith Chart (Admittance), Linear Polar, Log Polar, Group Delay, Linear Magnitude, Linear Magnitude and Phase, Real, Imaginary, Real & Imaginary, SWR, and Power			
	Data points	1601 maximum. Number of data points can be switched to a value of 801, 401, 201, 101, 51, 15, or 3 points without recalibration (if 1601 points were used in the calibration). In addition, the system accepts an arbitrary set of N discrete data points where 2 ≤ N ≤ 1601. CW mode permits selection of a single data point without recalibration.			
	Reference delay	Can be entered in time or in distance (when the dielectric constant is entered). Automatic reference delay feature adds the correct electrical length compensation at the push of a button. Software compensation for the electrical length difference between reference and test is always accurate and stable since measurement frequencies are always synthesized. In addition, the system compensates reference phase delay for dispersive transmission media such as microstrip.			
	Alternate sweep	Allows the ability to decouple channel 1 and 2 from channel 3 and 4 for the following parameters: correction type, start and stop frequencies, number of data points, markers, sweep time, averaging, smoothing, and IF bandwidth.			
	Markers	Twelve independent markers can be used to read out simultaneous measurement data. In alternate sweep mode there are sets of markers for each frequency sweep. In delta reference marker mode, any one marker can be selected as the reference for the other eleven. Markers can be directed automatically to the minimum or maximum of a data trace.			
	Enhanced markers	Marker search for a level or bandwidth, displaying an active marker for each channel, and discrete or continuous (interpolated) markers. Identifies the X dB bandwidth of amplifiers, filters, and other frequency sensitive devices.			
	Marker sweep	Sweeps upward in frequency between any two markers. Recalibration is not required during the marker sweep.			
	Limit lines	Either single or segmented limit lines can be displayed. Two limit lines are available for each trace.			
	Single limit readouts	Interpolation algorithm determines the exact intersection frequencies of data traces and limit lines.			
	Segmented limit lines	A total of 20 segments (10 upper and 10 lower) can be generated per data trace. Complete segmented traces can be offset in both frequency and amplitude.			
	Test limits	Both single and segmented limits can be used for PASS/FAIL testing. PASS or FAIL status is indicated on the display after each sweep. In addition, PASS/FAIL status is output through the rear panel I/O connector as selectable TTL levels (PASS=0V, FAIL=+5V, or PASS=+5V, FAIL=0V).			
	Tune mode	Tune Mode optimizes sweep speed in tuning applications by updating forward S-parameters more frequently than reverse ones. This mode lets users select the ratio of forward sweeps to reverse sweeps after a full 12-term calibration. The ratio of forward sweeps to reverse sweeps can be set anywhere between 1:1 to 10,000:1.			
Power sweep measurements	Both Swept Power Gain Compression and Swept Frequency Gain Compression modes are available.				
Sequencing	Seven measurement sequences can be created, stored, edited, and run from the front panel. Sequences can include front-panel functions as well as user-definable control statements. Sequences can be run from either the unit front panel, via GPIB, or from an AT-style keyboard plugged into the front panel.				
Harmonic measurement	Measurement/display of fundamental, 2 nd , 3 rd , 4 th , 5 th , 6 th , 7 th , 8 th , & 9 th harmonic				



Display capabilities	Display channels	Four, each of which can display any S-parameter or user-defined parameter in any format with up to two traces per channel for a maximum of eight traces simultaneously. Each channel is also capable of displaying harmonics, noise figure, intermodulation distortion, or time domain trace. A single channel, two channels (1 and 3, or 2 and 4), or all four channels can be displayed simultaneously. Channels 1 and 3, or channels 2 and 4, can be overlaid for rectilinear graph types.	
	Trace overlay	Displays two data traces on the active channel's graticule simultaneously. The overlaid trace is displayed in yellow and the primary trace is displayed in red.	
	Trace memory	A separate memory for each channel can be used to store measurement data for later display or subtraction, addition, multiplication or division with current measurement data.	
	Blank frequency information	Blanking function removes all references to displayed frequencies on the LCD. Frequency blanking can only be restored through a system reset or GPIB command.	
Measurement enhancements	Data averaging	Averaging of 1 to 4096 averages can be selected. The data averaging function is performed at each data point during the frequency sweep. Averaging can be toggled on or off via the front panel; a front-panel LED indicates that the data averaging function is enabled.	
	IF bandwidth	Soft Key selection of IF bandwidth (30 kHz, 10 kHz, 3 kHz, 1 kHz, 300 Hz, 100 Hz, 30 Hz, 10 Hz)	
	Trace smoothing	Computes an average over a percentage range of the data trace. The percentage of trace to be smoothed can be selected from 0 to 20% of trace.	
	Group delay characteristics	Group delay	Group delay is measured by computing the phase change in degrees across a frequency step by applying the formula: $T_g = \frac{-1/360 \text{ d(phase)}}{\text{d(frequency)}}$
		Aperture	Defined as the frequency span over which the phase change is computed at a given frequency point. The aperture can be changed without recalibration. The minimum aperture is the frequency range divided by the number of points in calibration and can be increased to 20% of the frequency range without recalibration. The frequency width of the aperture and the percent of the frequency range are displayed automatically.
		Range	The maximum delay range is limited to measuring no more than $\pm 180^\circ$ of phase change within the aperture set by the number of frequency points. A frequency step size of 100 kHz corresponds to 10 microseconds.
		Measurement repeatability (sweep to sweep)	For continuous measurement of a through connection, RSS fluctuations due to phase and FM noise are: $\frac{1.41 \{(\text{Phase Noise})^2 + (T_g \times \text{Residual FM Noise})^2\}^{.5}}{360 \text{ (Aperture in Hz)}}$
		Accuracy	Error in $T_g = \frac{\text{Error in phase}}{360} + \frac{(T_g \times \text{Aperture Freq. Error (Hz)})}{\text{Aperture}}$
		Frequency Translating Group Delay (FTGD)	Allows the measurement of group delay of mixers and other translating devices by analyzing the phase shift experienced by a modulated signal (generated internally). The above Group Delay equation applies, except that the phase change is measured across the modulating bandwidth of the test signal instead of across frequency points. The aperture is fixed at about 900 kHz and the range is limited to about 1 μ s. The use of angle modulation keeps the measurement relatively immune from compression and other non-linearities.
	LRL/LRM calibration capability	The LRL calibration technique uses the characteristic impedance of a length of transmission line as the calibration standard. A full LRL calibration consists merely of two transmission line measurements, a high reflection measurement, and an isolation measurement. The LRM calibration technique is a variation of the LRL technique that utilizes a precision termination rather than a second length of transmission line. A third optional standard, either Line or Match may be measured in order to extend the frequency range of the calibration. This extended calibration is achieved by mathematically concatenating either two LRL, two LRM, or one LRL and one LRM calibration(s). Using these techniques, full 12-term error correction can be performed on the MS462XX VNA.	
Dispersion compensation	Selectable as Coaxial (non-dispersive), Waveguide, or Microstrip (dispersive)		
Reference plane	Selectable as Middle of line 1 or Ends of line 1		
Corrected impedance	Determined by Calibration Standards		
AutoCal®	The Scorpion™ family will incorporate internal control of the 3658X-series AutoCal® modules.		
Hard copy	Printer	Scorpion™ supports the HP 2225C InkJet, HP QuietJet, HP DeskJet, HP LaserJet II, III, IV, & V Series, and Epson compatible printers with parallel (Centronics) interfaces. They are also compatible with the ANRITSU "CAP3700" program (outputs bitmap file over GPIB) and provide bitmap output over front panel to disk.	
	GPIB plotters	Scorpion™ supports the HP Models 7440A, 7470A, and 7475A and Tektronix Model HC100 plotters.	
Storage	Internal memory	Ten front panel states (setup/calibration) can be stored and recalled from nonvolatile memory locations. The current front panel setup is automatically stored in nonvolatile memory at instrument powerdown. When power is applied, the instrument returns to its last front-panel setup. The system will be able to exchange two stored calibrations in <0.5 s.	
	Internal nonvolatile memory	Used to store and recall measurement and calibration data and frontpanel setups. All files are MS-DOS compatible.	
	Internal floppy disk drive	A 3.5 inch diskette drive with 1.44 Mb formatted capacity is used to load measurement programs and to store and recall measurement and calibration data and front-panel setups.	
	Measurement data	102.8 kb per 1601 point S-parameter data file	
	Calibration data	187.3 kb per 1601 point S-parameter data file (12-term cal plus setup)	
	Trace memory file	12.8 kb per 1601 point channel	
GPIB	GPIB interfaces	2 ports	
	System GPIB (IEEE-488.2)	Connects to an external controller for use in remote programming of the network analyzer. Address can be set from the front panel and can range from 1 to 30.	
	Dedicated GPIB	Connects to external peripherals for network analyzer controlled operations (e.g. GPIB plotters, frequency counters, frequency synthesizers, and power meters).	

Continued on next page

General	Power requirements	85-240 V, 48-63 Hz, 540 VA maximum
	Dimensions	222H x 425W x 450D mm (8.75 x 16.75 x 17.75 in)
	Weight	16 kg (35 lb)
Environmental	Storage temperature range	-40°C to +75°C.
	Operating temperature range	0°C to +50°C (specifications apply at 23°C ±3 °C).
	Relative humidity	5% to 95% at +40°C.
EMC	Meets the emissions and immunity requirements of:	EMC Directive - 89/336/EEC
		EN50081-1:1992
		CISPR-11:1990/EN55011:1991 Group 1 Class A
		IMMUNITY Standard
		IEC 1000-4-2:1995/prEN50082-1:1995 - 4kV CD, 8kV AD IEC 1000-4-3:1995/ENV50140:1994 - 3V/m IEC 1000-4-4:1995/prEN50082-1:1995 -500V SL; 1000V PL IEC 1000-4-5:1995/prEN50082-1:1995 - 2kV L-E, 1kV L-L IEC 1000-4-6:1995/ENV50141:1994 IEC 1000-4-8:1995/prEN50082-1:1995 IEC 1000-4-11:1995/prEN50082-1:1995
Safety	Meets safety requirements of Low Voltage/Safety Standard 72/23/EEC - EN61010-1:1993	

Ordering information

Please specify model/order number, name, and quantity when ordering.

Model/Order No.	Name
MS4622A	Main frame 10MHz – 3GHz transmission/reflection
MS4622B	
MS4623A	
MS4623B	
Option 1	Options Rack mount kit with slides
Option 2	
Option 3A	
Option 3B	
Option 4*1	
Option 4B*1	
Option 5	
Option 6*2	
Option 7	
Option 8	
Option 10	
Option 11*3	
Option 13	
36581NNF/1	AutoCal® AutoCal®, Type N, 10 MHz to 6 GHz
36581KKF/1	
NC346A	Noise sources 5 dB ENR noise source (3.5 mm)
NC346B	

Model/Order No.	Name
3750LF	Calibration kits SMA/3.5 mm RF Cal Kit ≤6 GHz
3751LF	
3753LF	
3663LF	Verification kits Type N verification kit
3666LF	
3667LF	
15LL50-0.3A	Accessories 3.5 mm Male-Male Cable, 30 cm
15LL50-0.6A	
15LLF50-0.3A	
15LLF50-0.6A	
15NN50-0.3B	
15NN50-0.6B	
15NNF50-0.3B	
15NNF50-0.6B	
15NNF50-0.3B	
15NNF50-0.6B	

- *1: Does not include noise source
- *2: Port 3 is a receiving port only, unless using an external synthesizer.
- *3: Standard connector is N-female, no cost option for 3.5 mm (male), 3.5mm (female), N-male, or GPC-7

VECTOR NETWORK MEASUREMENT SYSTEM / DIRECT-ACCESS RECEIVER

MS4622C, MS4623C

10 MHz to 3 GHz

10 MHz to 6 GHz

For Measuring Antennas, Frequency Conversion, and Multiple-Output Devices



GPIB

The MS462XC series of RF vector network analyzers are configured as direct-access receivers for antenna, frequency conversion, and multiple output device measurements. The MS462XC offers ultimate flexibility to meet most receiver measurement needs while maintaining the ability to measure all four S parameters with the addition of a reflectometer setup at the front end of the receiver.

The MS462XC series offers two wide-band RF models covering the 10 MHz to 3 GHz or 6 GHz ranges, MS4622C, and MS4623C, respectively.

Applications

• **Mixers**

Mixers are integral components of most measurement systems. Mixer measurements are complicated by the fact that a LO is required and multiple frequencies are involved in the complete measurement of a mixer. In addition the mixer is non-linear so power levels must be carefully considered, and in many instances non-linear effects such as compression and intermodulation distortion must be measured. The MS462XC has many features that simplify mixer measurements. The MS462XC can include two built in sources, to provide both the LO

and RF signal required by the mixer – the system automatically tunes the receiver to the appropriate IF frequency. The unit can control additional external sources as required for intermodulation measurements. The setup of the sources is obviously quite important in a mixer measurement. The Mixer device type simplifies this task somewhat. It allows the quick selection of which source is to be the DUT LO. It allows simple selection of a fixed LO or fixed IF measurement scenario (and specifying that LO or IF frequency). And, it informs the receiver of what kind of DUT conversion to expect (up conversion |RF+LO|, down conversion |RF-LO|, or no conversions might be used for a quick leakage measurement). Activating the mixer device type also performs the important function of turning on both internal sources for front panel access (usually using ports 1 and 3 driving, port 2 being the receive port). Two ports are not allowed to drive simultaneously during normal S-parameter measurements.

• **Antennas**

Far-field measurements are enhanced with the speed of taking data over GPIB, using fast CW mode. Rates of 1 ms/data point can be achieved using internal triggering, 1.3 ms/point with external triggering, and 1.6 ms/point with GPIB triggering.

Specifications

General measurement and enhancement display capabilities are the same as those for the MS4622A/B, MS4623A/B.

Number of channels	Four measurement channels
Operating port power (A1, A2, B1 and B2)	-5 dBm for 0.1 dB compression
Maximum port power for no damage	+20 dBm
Noise floor	-100 dBm@10 Hz IF bandwidth (<3 GHz), typically >-120 dBm in narrowband sweep; -100 dBm@10 Hz IF bandwidth (>3 GHz), typically >-110 dBm in narrowband sweep
System dynamic range	97 dB
Power output range (ports 1, 2 and 3)	MS4622C: +10 to -85 dBm MS4623C: +7 to -85 dBm
Source match (RF1, RF2 and RF3)	-15 dB (uncorrected)
Port match (A1, A2, B1 and B2)	-12 dB (uncorrected)
Frequency range	MS4622C: 10 MHz to 3 GHz MS4623C: 10 MHz to 6 GHz
2nd internal source	Optional
Intermodulation Distortion	Optional
IMD (3rd order) dynamic range	70 dB with 10 Hz IF bandwidth @ 300 kHz tone separation and @ -20 dBm tone levels
IMD accuracy	±1 dB @ > -60 dBm levels
Power measurement accuracy	±1 dB without flat power calibration ±0.1 dB with flat power calibration
Full reversing transfer switch	Provided

Ordering information

Please specify model/order number, name, and quantity when ordering.

Model/Order No.	Name
MS4622C	Mainframe 10 MHz to 3 GHz direct receiver access
MS4623C	10 MHz to 6 GHz direct receiver access
	Options
Option 1	Rack mount kit with slides
Option 2	Time domain
Option 3C	2nd internal source (3 GHz source) + 3rd port
Option 3D	2nd internal source (3 GHz source) + 3rd port
Option 5	Frequency translated group delay
Option 6	3rd test port (only for B and C models)
Option 7	T/R step attenuator (only for A models, standard on B)
Option 8*1	Harmonic measurement
Option 10	AutoCal® control
Option 11*2	Test Port connector
Option 13	Intermodulation distortion

*1: Subject to frequency range limitations imposed by test set.

*2: Standard connector is N-female, no cost option for 3.5 mm (male), 3.5mm (female), N-male, or GPC-7

POWER AMPLIFIER TEST SYSTEM (PATS) ME7840A

800 to 2400 MHz, 100 Watts

Easy-to-Use System for Power Amplifier Design and Manufacturing



GPIB

PATS is a flexible, easy-to-use system for power amplifier design and manufacturing. It allows real-time, simultaneous tuning of various amplifier parameters, including IMD and hot S_{22} in both swept-frequency and swept-power modes. Adjacent Channel Power Ratio (ACPR) shows the performance of your PA under real-world modulated conditions and is available with swept power mode. The following table summarizes the PATS measurement capability between 800 and 2400 MHz for applications up to 100 Watts.

Measurement capabilities:

Measurements	CW	Swept Frequency (as fast as 150 μ secs/pt)	Swept Power (as fast as 150 μ secs/pt)
ACPR	√		√*
S-Parameters Hot S_{22}	√	√	√
IMD, TOI (two-tone): 3 rd , 5 th , 7 th , & 9 th	√	√	√
Gain Compression: P_1 dB AM/PM	√ √	√	√ √
Harmonics: Magnitude Phase	√	√ √	√
Power Added Efficiency (PAE)	√	√	√
Drain Current	√	√	√

* Swept power speed is related to external source

PATS consists of three distinct parts: The MS462xC Vector Network Measurement System, the MS4782D Test Set, and the Scorpion PA Navigator.

• MS462xC Vector Network Measurement System

The MS462xC is the Direct Receiver Access (DRA) configuration for the MS462xx family of Vector Network Measurement Systems (VNMS). The MS462xC series is available in two wide-band RF models covering the 10 MHz to 3 GHz or 6 GHz range (MS4622C and MS4623C respectively).

• MS4782D Test Set

The MS4782D Test Set provides the necessary hardware to interface between your power amplifier and the VNMS.

• Scorpion PA Navigator

The Scorpion PA Navigator is installed on your computer to orchestrate the PATS measurements. The computer should be a Pentium II at 200 MHz or equivalent system with a GPIB Card (computer not included).

PATS Block Diagram

The following block diagram depicts the standard MS4782D Test Set design. Anritsu can configure and optimize a custom test set for your specific requirements.

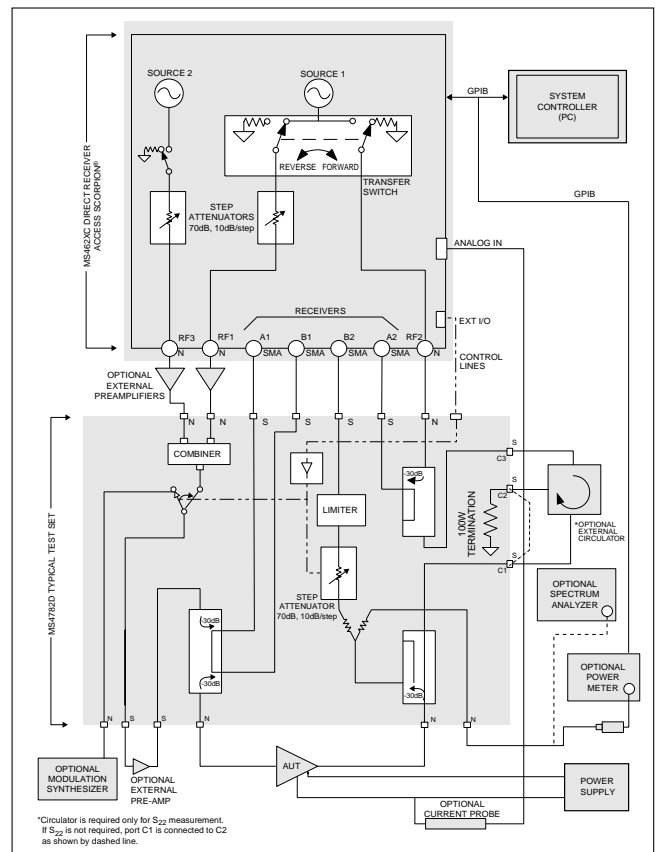

*Circulator is required only for S_{22} measurement. If S_{22} is not required, port C1 is connected to C2 as shown by dashed line.

PATS Software Results

With frequency sweeps as fast as 150 μ s/point and power sweeps as fast as 150 μ s/point, you can quickly, thoroughly, and accurately characterize your power amplifiers in real-time. Simultaneously overlay measurements in both frequency and power and see the results of over 250 datapoints updated twice per second.

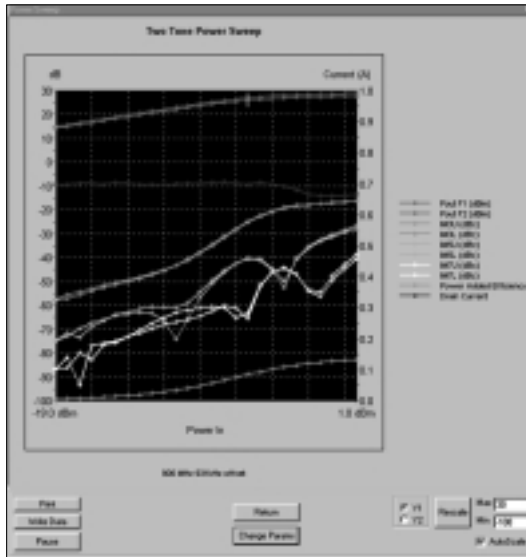

Specifications

Characteristic	Value	Notes
Amplifier Under Test Power Output	100W max	Without Hot S ₂₂ provision (Contact Anritsu for custom designs for higher power)
Bandwidth through Test Set	800 MHz – 2.4 GHz	Without S ₂₂ provision (Contact Anritsu for custom designs for different frequency ranges)
Amplifier Under Test Input Power range available from PATS	-85 dBm to +10 dBm	This value is for each tone, at combiner input. Provision for preamplifiers provided for greater levels
IMD (3 rd order) Dynamic Range	70 dB min	With 10 Hz IF bandwidth @ 300 kHz tone separation and -20 dBm tone levels
IMD Accuracy	±1 dB max	@ >-60 dBc levels
Port Power Accuracy	±0.1 dB typical	With flat power calibration
	±1 dB max	Without flat power calibration
Dynamic Range	80 dB min	Over-all system including Test Set
Port Match (test ports 1 & 2)	40 dB min	Corrected value
Port Match (test ports 1 & 2)	13 dB min	Uncorrected value
Directivity	40 dB	800 MHz – 2.4 GHz, Corrected value

Ordering information

Please specify model/order number, name, and quantity when ordering. Anritsu can configure and optimize a custom test set for your specific requirements. The following information represents the standard configuration and options.

Model/Order No.	Name
ME7840A MS4623C*1,2 MS4600/3D	Main frame PATS, 800 to 2400 MHz, 100 Watts Scorpion®, DRA configuration, 10 MHz to 6 GHz Scorpion® optional 6 GHz internal source with 3rd test port
MS4600/8 MS4600/13 MS4782D 43425	Scorpion® optional harmonic measurement application Scorpion® optional intermodulation distortion application PATS Test Set (100 Watts, 800 – 2400 MHz) ³ Accessories and interconnect kit Scorpion PA Navigator
ME7840/1 ME7840/2 ME7840/3	Replace MS4623C with MS4622C (3 GHz option) Replace MS4782D test set with MS4782A Delete Test Set
	Circulators <i>Circulators may be required for measurements of Hot S₂₂:</i> Circulator, 800 – 1000 MHz, 20 dB min, 50 Watts Max AUT Power
1000-50	Circulator, 1.8 – 2.5 GHz, 20 dB min, 50 Watts Max AUT Power, (connecting cable(s) not included)
1000-52	Circulator, 1.8 – 2.5 GHz, 22 dB min, 79 Watts Max AUT Power
1000-53	Note: All circulators have 3 SMA female connectors.
	Current Probes <i>Current Probes are required for drain current and Power Added Efficiency (PAE) calculations:</i> Current Probe Max current: 100mV/A:10A, 10mV/A:100A Accuracy (at lesser current range setting): 3% of reading ±50mA
2000-1067	Current Probe Max current: 1mV/mA:1A, 10mV/A:80A Accuracy (at lesser current range setting): 2% of reading ±5mA
2000-1085	Current Probe Max current: 1mV/mA:1A, 10mV/A:80A Accuracy (at lesser current range setting): 2% of reading ±5mA
3750LF 3753LF	Calibration kits SMA/3.5 mm RF Cal Kit (6 GHz) Type N RF Cal Kit (6 GHz)
36581NNF/1 36581KKF/1	AutoCal® AutoCal, Type N, 10 MHz to 6 GHz AutoCal, Type K, 10 MHz to 6 GHz
15LL50-0.3A 15LL50-0.6A 15LLF50-0.3A 15LLF50-0.6A 15NN50-0.3B 15NN50-0.6B 15NNF50-0.3B 15NNF50-0.6B	Economy cables 3.5 mm Male-Male Cable, 30 cm 3.5 mm Male-Male Cable, 60 cm 3.5 mm Male-Female Cable, 30 cm 3.5 mm Male-Female Cable, 60 cm Type N Male-Male Cable, 30 cm Type N Male-Male Cable, 60 cm Type N Male-Female Cable, 30 cm Type N Male-Female Cable, 60 cm

*1: ME7840A standard connector type is N-female.

*2: Scorpion® DRA rear panel Reference Channel Connectors a1, a2, b1, and b2 are SMA-female connectors.

*3: Special test sets can be configured for other power levels and frequency ranges.

VECTOR NETWORK ANALYZERS 37100C, 37200C, 37300C Series

22.5 MHz to 65 GHz

For Fast and Accurate S-Parameter Measurements



GPIB

The 37200C and 37300C series microwave vector network analyzers (VNAs) are high performance tools designed to make fast and accurate S-parameter measurements across the 22.5 MHz to 65 GHz range. These network analyzers integrate a synthesized source, S-parameter test set, and tuned receiver into a single compact package that is ideal for benchtop testing.

Code named Lightning, the 37200C and 37300C offer new levels of measurement capabilities to speed manufacturing test and increase throughput. Choose the instrument model and options that best suit your application and budget.

The 37200C series is designed for passive device measurements, while the 37300C series adds active device measurement capabilities. The 37217C/37317C is an economical choice for lower frequency component testing up to 8.6 GHz. Higher frequency solutions to 13.5, 20, 40, 50, and 65 GHz are available in microwave models 37225C/37325C, 37247C/37347C, 37269C/37369C, 37277C/37377C, and 37297C/37397C, respectively.

The 37100C series microwave vector network analyzers are configured as direct-access receivers for antenna, frequency conversion, and multiple output device measurements. The 37100C offers ultimate flexibility to meet most receiver measurement needs while maintaining the ability to measure all four S parameters with the addition of a reflectometer setup at the front end of the receiver.

The 37100C series offers two wide-band microwave models covering the 22.5 MHz to 20 GHz or 40 GHz ranges, 37147C, and 37169C, respectively.

Features

● Next generation VNA technology

The 37100C/37200C/37300C series incorporates a higher speed processor and faster power sweep capability.

● High speed data transfer and control

For maximum efficiency, dual GPIB ports are standard on every 37100C/37200C/37300C series VNA. High-speed transfers across the analyzer's IEEE 488.2 GPIB bus minimize data collection times. The second GPIB port is dedicated to control of peripheral devices such as printers, plotters, power meters, and frequency synthesizers. The 37100C/37200C/37300C series maximizes throughput by combining fast, error-corrected sweeps with high-speed data transfers. Measurement throughput for the 37100C/37200C/37300C series ranks as the fastest of any microwave analyzer in the industry.

● Compact size

The 37200C/37300C series analyzers integrate a fast sweeping synthesized source, auto-reversing S-parameter test set, and four-channel receiver into a single compact package. The 37100C series analyzers integrate a fast sweeping synthesized source and four-channel receiver into a single compact package and provides direct access to all four receiver samplers via the front panel. Components within the analyzer have been integrated to reduce cost and weight and improve the instrument's long-term reliability. Despite its small size, the 37100C/37200C/37300C series analyzers rival the performance normally found in larger, more expensive vector systems.

● Built-in mass storage

Testing devices with multiple setups is now easier. A built-in hard disk drive rapidly stores and recalls frequently used front panel setups and calibrations. Store your complete test setup including limit lines and frequency markers. Create descriptive file names to assist multiple users or device types. The high storage capability of the internal hard disk means there is space for literally hundreds of calibrations, front panel setups, and data traces. In secure environments, the internal hard disk can be removed and either an external drive on the SCSI port or the internal 1.44 MB floppy drive can be used for uploading proprietary setups.

● Fast synthesized sweeps

Measurement update rates of less than 2 ms per point are possible with the 37100C/37200C/37300C series analyzers. Each data point is fully phase-locked and vector-error-corrected for optimum accuracy. Realize near real-time updates with the instrument's tune mode. The internal source frequency resolution of 1 kHz satisfies most wide- and narrow-band requirements. Devices requiring more frequency definition can be evaluated with 1 Hz frequency resolution (Option 10A).

● Time domain analysis

Analyze impedance discontinuities as a function of time or distance with the 37100C/37200C/37300C's high-speed time domain (Option 2A). Isolate individual reflections in time and evaluate their effects in the frequency domain. Remove the effects of device packages and fixturing with time domain gating to see the actual performance of your designs. Use the independent display channels to view the response of your designs before, during, and after time domain processing. The software provides four different windowing functions to optimize

dynamic range and resolution. The exclusive phasor impulse mode will show you the true impedance characteristics of mismatches in waveguide, microstrip, and other band-limited media.

● Multiple source control

Conveniently test mixers and multipliers through the 37100C/37200C/37300C's multiple source control. Separately control the frequency of two sources and a receiver without the need for an external controller. Independently specify the sweep ranges and output powers of the sources and the sweep range of the receiver to accommodate testing of frequency translation devices.

● LabVIEW® compatibility

Standard with every 37100C/37200C/37300C series analyzer is National Instruments LabVIEW® instrument driver. Create custom test programs (virtual instruments) in less time with LabVIEW®'s graphical programming environment. Take advantage of the network analyzer's high data throughput for tuning operations. Fast data transfers over GPIB permit near realtime updates on your PC's display. Customize programs to automatically display, test, and document measurement results. Reuse virtual instruments in other test routines to minimize program development time. LabVIEW® gives you full access to more than 900 mnemonics in the 37100C/37200C/37300C analyzer's command set for complete automated data collection and analysis.

● Internally controlled AutoCal®

One source of potential errors and inaccuracies in any network analyzer system is the calibration of that system. The Anritsu AutoCal automatic calibrator is designed to speed and simplify the calibration of your 37200C/37300C VNA. Using the built-in software support and an AutoCal module connected to the serial port on the rear panel of the instrument, you are ready to make fast, accurate, and repeatable calibrations.

● Three-year factory warranty

All 37100C/37200C/37300C series VNAs are backed with a no-questions-asked three-year warranty.

● Upgradeability

The 37100C/37200C/37300C series analyzers are designed to accommodate higher frequency ranges and more powerful features as your requirements grow. Any 37100C/37200C/37300C series VNA can be upgraded to any other model in the instrument family, or any other series, to fit your changing requirements. Contact Anritsu Customer Service to request an upgrade and an Anritsu service engineer will install the added capability and verify your system's total performance. Upgradeability is a cost-effective approach to satisfying today's production needs while providing the flexibility to meet tomorrow's demands. System software upgrades are as easy as inserting new discs into the instrument's floppy drive.

Applications

● Filters

Let the analyzer's wide dynamic range show you filter rejection and input match on the same display. Overlay traces and tune for optimum transmission and group delay responses without reduction in sweep speed.

Further speed improvements are possible using the instrument's tune mode. This unique feature helps users optimize sweep times in one direction for better hand-to-eye tuning while maintaining a 12-term corrected S-parameter display. Anritsu's tune mode maximizes sweep speed and accuracy, simultaneously, by allowing you to choose when reverse parameters are updated.

Automatically locate filter center frequency, 3 dB bandwidth, max/min insertion loss, 0 dB points, Q, and shape factor. Instantly measure passband phase distortions with Anritsu's automatic reference plane extension capability. A single key press quickly identifies filter non-linear responses.

● Amplifiers (available on 37300C series only)

Easily measure amplifier gain compression vs. input power or frequency. Power meter assisted flat output power calibration provides capability to measure power in dBm. A 1 watt, 70 dB (60 dB on >40 GHz models) step attenuator in the port 1 path, and a 40 dB step attenuator in the port 2 path, coupled with 20 dB ALC range, give complete control to characterize virtually any amplifier. This range is reduced to 12 dB at frequencies >50 GHz. Internal bias tees simplify DC biasing of your active designs. A front panel loop allows external amplifier insertion, increasing port 1 power up to 1 watt for high input power amplifiers.

● Mixers

Mixers as multiport devices take advantage of the multiple source control and set-on receiver mode features.

The 37100C/37200C/37300C can be configured to measure the relative harmonic level of test devices with set-on receiver mode capability. The 37100C/37200C/37300C's unique phase locking scheme allows it to operate as a tuned receiver by locking all of its local oscillators to its internal crystal reference oscillator. Set-on receiver mode capability significantly increases the versatility of the 37100C/37200C/37300C VNA in applications that check for harmonics, intermodulation products, and signals of known frequency.

Multiple source control capability allows a user to independently control the frequencies of two sources and the receiver without the need for an external controller. The frequency ranges and output powers of the two sources may be specified. A frequency sweep may be comprised of up to five separate bands, each with independent source and receiver settings, for convenient testing of frequency translation devices such as mixers. Up to five sub-bands may be tested in one sweep. This feature enables users to easily test mixers, up/down converters, multipliers, and other frequency conversion devices.

● Microstrip devices

The 37200C/37300C series offers complete substrate measurement solutions for both microstrip and coplanar waveguide (CPW) designs. The 37200C/37300C series analyzers accommodate the model 3680 series Universal Test Fixtures (UTF), calibration kits, and verification kits. Guaranteed system specifications provide assurance that your test results are accurate and verifiable.

Completely characterize connectorless devices with the 37200C/37300C's Line-Reflect-Line (LRL) and Line-Reflect-Match (LRM) calibration capability. The four channel design provides true LRL/LRM error-correction giving you the highest performance available for in-fixture measurements. Highly reflective devices, along with well matched ones are measured with the same degree of ease. Automatic dispersion compensation improves measurement accuracy to help you determine phase distortions in all your microstrip designs. The result is quality measurements you can count on for your connectorless devices.

● Antennas

Far field measurements are enhanced with the speed of taking data over GPIB, using the 37100C in fast CW mode. Rates of 0.8 ms/point can be achieved using internal triggering, 1.2 ms/point with external triggering, and 1.5 ms/point with GPIB triggering.

For near field measurements, internal buffer data collection is provided to allow saving active channel measurement data from multiple sweeps without having to synchronize and collect data at the end of each sweep. The 37100C can store up to 50,000 data point measurements, each consisting of two real and imaginary IEEE 754 4-byte floating point numbers.

● Multiport devices

The 37100C offers direct access to all four samplers. Flat test port power calibration using a power meter allows source calibration and characterization of all four receiver channels. Ratioed measurements can then be performed on any combination of the four channels. Absolute dBm measurements can also be made through the user-defined parameter feature.

Specifications

Measurement capabilities	Number of channels	Four measurement channels
	Parameters	S ₁₁ , S ₂₁ , S ₁₂ , S ₂₂ ; or user defined, complex input and output impedance; complex input or output admittance; complex forward and reverse transmission
	Domains	Frequency domain, CW draw, and optional high speed time domain (Option 2A)
	Formats	Log magnitude, phase, log magnitude and phase, Smith chart (impedance), Smith chart (admittance), linear polar, log polar, group delay, linear magnitude, linear magnitude and phase, real, imaginary, real and imaginary, and SWR
	Data points	1601 maximum. System also accepts an arbitrary set of N discrete data points where 2 ≤ N ≤ 1601. CW mode permits selection of a single point.
	Reference delay	Can be entered in time or in distance. Automatic reference delay adds the correct electrical length compensation at the push of a button. Software compensation for the electrical length difference between the reference and test is accurate and stable since measurement frequencies are always synthesized.
	Markers	Six independent markers can be used to read out measurement data. In delta-reference mode, any one marker can be selected as the reference for the other five. Markers can automatically find critical filter parameters i.e. 3 dB bandwidth, loss, center frequency, shape factor and Q.
	Marker sweep	Sweeps upward in frequency between any two markers. Recalibration is not required during the marker sweep.
	Limits	Two limit lines per data trace to indicate test limits. Limits can be either single or segmented limits for testing devices pass-fail.
	Measurement dynamic range	Table 1 gives receiver dynamic range as the ratio of maximum signal level at Port 2 (or individual sampler input) to the noise floor.
	Data averaging	Averaging of 1 to 4096 averages per data point can be selected.
	IF bandwidth	Front panel switch selects four levels of IF bandwidth: 10 kHz, 1 kHz, 100 Hz and 10 Hz
Display capabilities	Display channels	1, 2, 3 or 4 channels can be displayed. Each channel can display any S-parameter or user defined parameter in any format with up to two traces per channel for a maximum of eight traces simultaneously.
	Display type	Color LCD, 8.5" diagonally, VGA display. Color of graticule, trace data and text are user definable.
	Trace overlay	Overlays two traces with the same graticule type on the same display
	Trace memory	A separate memory for each channel can be used to store measurement data for later display or subtraction, addition, multiplication or division.
	Scale resolution	Log mag: 0.001 dB, linear mag: 1 pU Phase: 0.01°, group delay: 0.001 ps Time: 0.001 ms, distance: 0.1 mm SWR: 1 pU Power: 0.05 dB
	Autoscale	Automatically sets resolution and offset to display measurement data on the full display
	Reference position	Settable to any graticule line
Annotation	Type of measurement, vertical and horizontal scale resolution, start and stop frequencies and reference position	
Vector error correction	Error correction models	Full 12-term, one-path two-port, reflection only, transmission response
	LRL/LRM	Line-Reflect-Line and Line-Reflect-Match calibration models are available for coaxial, microstrip and waveguide transmission lines.
Signal source capabilities	Source power level	Source power may be set from the 37100C/37200C/37300C front panel menu. Check table 2 for levels.
	Flat power correction	The 37100C/37200C/37300C corrects for test port power variations using an external power meter. Once the port power has been flattened, the power meter is removed and the signal source power level may be changed within the remaining power adjustment range.
	Multiple source control	Allows a user to separately control the frequency of two sources and receiver without need for an external controller. Source #1: 37200C/37300C internal source, or any 68000C or 69000B synthesizer Source #2: Any 68000C or 69000B synthesizer Receiver: 37200C/37300C internal receiver
	Internal 10 MHz time base stability	Standard With aging: <1 x 10 ⁻⁶ /day With temperature: <1 x 10 ⁻⁶ over 15° to 50°C High stability time base (Option 10A) With aging: <1 x 10 ⁻⁹ /day With temperature: <5 x 10 ⁻⁹ over 0° to 55°C
Hard copy	Printers	Select full screen, graphical, tabular data, and printer type. Compatible with most HP and Epson printers with a parallel (Centronics) interface
	GPIB plotters	Compatible with most HP and Tektronix plotters
Storage	Internal memory	Ten front panel states (setup) can be stored and recalled from non-volatile memory locations.
	Internal hard disk drive	Used to store and recall setup and calibration files, trace data and tabular data files. All files are MS-DOS compatible.
	Internal floppy disk drive	Stores and recalls setup and calibration files from 3.5 inch 1.44 MB floppy disks. All files are MS-DOS compatible.
Remote programming	Interface	GPIB (IEEE 488.2)
	Addressing	Address can be set from the front panel and can range from 1 to 30.
	Transfer formats	ASCII, 32-bit floating point and 64-bit floating point
	Speed	150 kB/sec
	Interface function codes	SH1, AH1, T6, TE0, L4, LE0, SR1, RL1, PP1, DT1, DC0, C0
General	Test ports	GPC-7, 3.5 mm, N-type, K, and V connectors supported
	Power requirements	85 to 240 V, 48 to 63 Hz, 540 VA maximum
	Dimensions	432 (W) x 267 (H) x 585 (D) mm (10.5 x 17 x 23 in)
	Mass	27 kg (60 lbs)
	Temperature	0° to 50°C (operate), -40° to 75°C (storage)

Table 1a Dynamic range (37100C)

Model	Frequency (GHz)	Max. signal into a _x , b _x (dBm)	Noise floor (dBm)	Receiver dynamic range (dB)	Source power (dBm, typical)
37147C	0.0225	-18	-122	104	10
	2	-12	-106	94	8
	20	-12	-103	91	5
37169C	0.0225	-18	-122	104	10
	2	-12	-106	94	8
	20	-12	-103	91	3
	40	-15	-100	85	-3

Table 1b Dynamic range (37200C/37300C)

Model	Frequency (GHz)	Max. signal into port 2 (dBm)	Noise floor (dBm)	Receiver dynamic range (dB)	Port 1 power (dBm, typical)	System dynamic range (dB)
37217C	0.0225	+3	-95	98	0	95
	2	+3	-98	101	0	98
	8.6	+3	-98	101	0	98
37225C	0.04	+20	-70	90	0	70
	2	+3	-98	101	0	98
	13.5	+3	-98	101	0	98
37247C	0.04	+20	-70	90	0	70
	2	+3	-98	101	0	98
	20	+3	-96	99	0	96
37269C	0.04	+20	-70	90	0	70
	2	+3	-98	101	0	98
	20	+3	-95	98	-5	90
	40	+3	-93	96	-15	78
37277C	0.04	+20	-77	97	0	77
	2	+3	-105	108	+5	110
	20	+3	-97	100	-2	95
	40	+3	-95	98	-7	88
	50	+3	-87	90	-2	85
37297C	0.04	+20	-77	97	0	77
	2	+3	-105	108	+5	110
	20	+3	-97	100	-2	95
	40	+3	-95	98	-7	88
	50	+3	-87	90	-2	85
	65	+3	-77	80	-2	75
37317C	0.0225	+30	-95	125	0	95
	2	+30	-98	128	0	98
	8.6	+30	-98	128	0	98
37325C	0.04	+30	-65	95	+5	70
	2	+30	-93	123	+5	98
	13.5	+30	-93	123	+5	98
37347C	0.04	+30	-65	95	+5	70
	2	+30	-93	123	+5	98
	20	+30	-91	121	+5	96
37369C	0.04	+30	-65	95	+5	70
	2	+30	-93	123	+5	98
	20	+30	-90	120	0	90
	40	+30	-83	113	-7	76
37377C	0.04	+30	-77	107	0	77
	2	+30	-105	135	+5	110
	20	+30	-97	127	-2	95
	40	+30	-95	125	-7	88
	50	+30	-87	117	-2	85
37397C	0.04	+30	-77	107	0	77
	2	+30	-105	135	+5	110
	20	+30	-97	127	-2	95
	40	+30	-95	125	-7	88
	50	+30	-87	117	-2	85
	65	+30	-77	107	-2	75

Table 2 Power range

Model	Rated power (dBm)	Minimum power (dBm)	Resolution (dB)
37147C	+5	-15	0.05
37169C	-3	-23	
37217C	0	-20	
37225C			
37247C	-15	-27	
37269C			
37277C			
37297C	-7	-19	
37317C	0	-95	
37325C	+5	-90	
37347C			
37369C	-7	-97	
37377C	-7	-87	
37397C	-7	-79	

Ordering information

Please specify model/order number, name, and quantity when ordering.

Model/Order No.	Name
	Main frame
37147C	Direct Access Receiver (22.5 MHz to 20 GHz)
37169C	Direct Access Receiver (22.5 MHz to 40 GHz)
37217C	Vector Network Analyzer (22.5 MHz to 8.6 GHz)
37225C	Vector Network Analyzer (40 MHz to 13.5 GHz)
37247C	Vector Network Analyzer (40 MHz to 20 GHz)
37269C	Vector Network Analyzer (40 MHz to 40 GHz)
37277C	Vector Network Analyzer (40 MHz to 50 GHz)
37297C	Vector Network Analyzer (40 MHz to 65 GHz)
37317C	Vector Network Analyzer (22.5 MHz to 8.6 GHz)
37325C	Vector Network Analyzer (40 MHz to 13.5 GHz)
37347C	Vector Network Analyzer (40 MHz to 20 GHz)
37369C	Vector Network Analyzer (40 MHz to 40 GHz)
37377C	Vector Network Analyzer (40 MHz to 50 GHz)
37397C	Vector Network Analyzer (40 MHz to 65 GHz)
	Options
Option 1	Rack mount kit with slides
Option 2A	High-speed time (distance) domain capability
Option 4	External SCSI-2 hard disk drive compatibility (internal HDD removed)
Option 7A	Replaces universal K connector (standard) with universal GPC-7 (37200C/37300C only)
Option 7N	Replaces universal K connector (standard) with universal N-male (37200C/37300C only)
Option 7NF	Replaces universal K connector (standard) with universal N-female (37200C/37300C only)
Option 7S	Replaces universal K connector (standard) with universal 3.5 mm-male (37200C/37300C only)
Option 7K	Replaces universal V connector (standard) with universal K (m) (37277C/37297C/37377C/37397C models only)
Option 10A	High stability (ovenized) time base and 1 Hz frequency resolution
Option 11	Reference loop extension cables (standard on 37300C series)
Option 12	Rear Panel IF Inputs (for 37x97C and 37x77C only). Required for upgrade to ME7808A Broadband VNA.
	Calibration kits
3650	SMA/3.5 mm Calibration Kit
Option 1	Adds sliding terminations
3651	GPC-7 Calibration Kit
Option 1	Adds sliding terminations
3652	K Connector Calibration Kit
Option 1	Adds sliding terminations
3653	Type N Calibration Kit
3654B	V Connector Calibration Kit with sliding terminations
3750	SMA/3.5 mm Economy Calibration Kit (<8.6 GHz)
3751	GPC-7 Economy Calibration Kit (<8.6 GHz)
3753	Type N Economy Calibration Kit (<8.6 GHz)
36581NNF	AutoCal, N (m) to N (f), 40 MHz to 18 GHz
36581KKF	AutoCal, K (m) to K (f), 40 MHz to 20 GHz
36582KKF	AutoCal, K (m) to K (f), 40 MHz to 40 GHz

* Call your Anritsu representative for 50 and 65 GHz upgrades.

Model/Order No.	Name
	Verification kits
3663	Type N Verification Kit
3666	SMA/3.5 mm Verification Kit
3667	GPC-7 Verification Kit
3668	K Connector Verification Kit
3669B	V Connector Verification Kit
	Test port cables
3670A50-1	GPC-7 semi-rigid cable, 1 foot
3670A50-2	GPC-7 semi-rigid cable, 2 foot
3670K50-1	K connector semi-rigid cable, 1 foot
3670K50-2	K connector semi-rigid cable, 2 foot
3670V50-1	V connector semi-rigid cable, 1 foot
3670V50-2	V connector semi-rigid cable, 2 foot
3671A50-1	GPC-7 flexible cables, 25 in. (1 pair)
3671A50-2	GPC-7 flexible cables, 38 in.
3671S50-1	3.5 mm flexible cables, 25 in. (1 pair)
3671S50-2	3.5 mm flexible cables, 38 in.
3671K50-1	K connector flexible cables, 25 in. (1 pair)
3671K50-2	K connector flexible cables, 38 in.
3671V50-3	V connector flexible cable, 25 in. (1 pair)
3671V50-4	V connector flexible cable, 38 in.

MILLIMETER WAVE VECTOR NETWORK ANALYZER

37000 Family

33 to 140 GHz

High Performance Millimeter Wave Vector Network Analysis



GPIB

7

The 37000 family millimeter wave vector network analyzer (VNA) extends the exceptional performance of the Lightning VNA family to 140 GHz. This improvement to our original millimeter wave system, based on the 360B VNA, continues our commitment to providing the highest quality microwave and millimeter wave test equipment available while still maintaining an intuitive user interface. The minimum configuration for the millimeter wave VNA has a 37147C VNA, a 3735B Test Set, two synthesized sources, and a pair of millimeter heads.

Features

• Measurement speed and accuracy

The millimeter wave VNA, based on our popular Lightning 37000 platform, offers the fastest measurement speed available in a millimeter wave VNA. Measurement speed of approximately 20 ms per point for an 801 data point sweep means faster tuning and throughput for your millimeter wave devices. The millimeter wave system also offers full auto-reversing, 12-term, error-corrected S-parameter measurements that enable advanced calibration techniques such as Line-Reflect-Line (LRL), Line-Reflect-Match (LRM), and Thru-Reflect-Match (TRM) to be used for maximum accuracy in your on-wafer measurements. For waveguide measurements, the millimeter wave system supports all of the above methods as well as the off-set short calibration technique. The 8.5 inch, color liquid crystal display (LCD) allows users to easily view the data traces for all four S-parameters while simultaneously displaying limit lines and trace memory functions. The built-in 3.5 inch MS-DOS® compatible floppy disk drive and internal hard disk drive simplify the procedure to both store and recall calibrations, front panel setups, and measurement data. The versatility of the Lightning platform allows data to be gathered using the *.s2p, *.txt, *.dat, *.bmp, *.hgl, and the *.wrf file format so data can be easily loaded into both circuit simulation and graphics programs.

• The most dynamic range in a millimeter VNA

Increased dynamic range relates directly to increased measurement accuracy and confidence when measuring millimeter wave components and subsystems. To achieve optimum measurement speed and dynamic range for your measurements, the Lightning millimeter wave VNA allows the number of measurement averages and video IF bandwidth to be varied. The Lightning millimeter wave VNA sys-

tem dynamic range is typically 15 dB better than comparable VNAs, and noise floor specifications are measured with 512 averages not 1024 averages — an important point to consider when making comparisons. Simply stated, the Lightning millimeter wave system provides the best dynamic range with sweep speeds twice as fast as comparable instruments.

• Flexible configuration in waveguide and coax

Our flexible module configurations let you specify the capability of your millimeter wave VNA. We offer two versions of millimeter wave heads that allow you to tailor the Lightning based millimeter system to your exact measurement needs. The 3740A series transmission/reflection modules have simultaneous transmission and reflection capability, while the 3741A series transmission only module is used when reflection measurements are not required. A pair of 3740A modules allows measurement of all four S-parameters. A 3740A transmission/reflection module combined with a 3741A Transmission Only module allows measurement of one-path/two port S-parameters (S₁₁ and S₂₁).

A single 3740A transmission/reflection module can be used for S₁₁ reflection measurements. The 3740A series also provides the smallest footprint and lightest weight of any millimeter wave test head on the market today. This greatly simplifies your test setup; regardless of whether you are manually adjusting the head position for waveguide measurements or have attached them to a wafer probe station. In order to maximize the flexibility of your VNA, the system architecture provides for a smooth transition between your waveguide and coaxial device measurements. Simply add a coaxial test set to your system and now you have the capabilities to fully characterize your active and passive coaxial devices up to 40 GHz.

• Complete measurement solutions

In addition to the millimeter wave VNA measurement system, Anritsu offers a full line of power meters and synthesized signal generators up to 110 GHz. To complete your millimeter wave measurement setup, Anritsu also offers solutions for waveguide, on-wafer, and even coaxial applications. With our custom design and manufacturing capabilities, we have developed 110 GHz coaxial connectors, couplers, adapters, and even test fixtures for use in your millimeter wave test set-ups.

Specifications

• System performance

Waveguide designation	Q-Band (WR-22)	V-Band (WR-15)	E-Band (WR-12)	Extended E-Band	W-Band (WR-10)	Extended W-Band	F-Band (WR-8)
Frequency range (GHz)	33 to 50	50 to 75	60 to 90	56 to 60 60 to 85 85 to 94	75 to 100 100 to 110	65 to 75 75 to 100 100 to 110	90 to 115 115 to 140
Maximum signal into port 2 (dBm)	+10	+8	+8	+8	+6	+6	+4
Noise floor (dBm)	-93	-90	-90	-85 -90 -76	-90 -90	-90 -89 -87	-88 -87
Receiver dynamic range (dB) ^{*1}	103	98	98	93 98 84	96 96	96 95 93	92 91
High level noise (dB, typical)	.02	.05	.06	.08	.06	.08	.08
Power @ DUT (dBm, typical)	+7	+7	+6	+5 +6 +4	+5 +2	-5 +5 +2	-3 -7
System dynamic range (dB) ^{*2}	100	97	96	90 96 80	95 92	85 94 89	85 80

*1: "Receiver dynamic range" is defined as the ratio of the maximum signal level at Port 2 for 0.1 dB compression to the system noise floor.

*2: "System dynamic range" is defined as the ratio of the power at Port 1 and the system noise floor (forward measurements only).

• Test port characteristics

Waveguide designation	Offset short calibration ^{*1}						
	Q-Band (WR-22)	V-Band (WR-15)	E-Band (WR-12)	Extended E-Band	W-Band (WR-10)	Extended W-Band	F-Band (WR-8)
Frequency (GHz)	33 to 50	50 to 75	60 to 90	56 to 94	75 to 110	65 to 110	90 to 140
Directivity (dB)	>50	>50	>46	>44	>46	>40	>45
Source match (dB)	>45	>37	>36	>33	>36	>30	>34
Load match (dB)	>50	>50	>46	>44	>46	>40	>45
Reflection frequency tracking (dB)	±0.010	±0.030	±0.040	±0.080	±0.040	±0.080	±0.060
Transmission frequency tracking (dB)	±0.010	±0.060	±0.060	±0.1	±0.070	±0.1	±0.1
Isolation (dB)	>100	>90	>90	>80	>90	>80	>80

Waveguide designation	LRL calibration ^{*1}						
	Q-Band (WR-22)	V-Band (WR-15)	E-Band (WR-12)	Extended E-Band	W-Band (WR-10)	Extended W-Band	F-Band (WR-8)
Frequency (GHz)	33 to 50	50 to 75	60 to 90	56 to 94	75 to 110	65 to 110	90 to 140
Directivity (dB)	>50	>50	>46	>44	>46	>40	>45
Source match (dB)	>50	>50	>46	>43	>46	>40	>45
Load match (dB)	>50	>50	>46	>44	>46	>40	>45
Reflection frequency tracking (dB)	±0.002	±0.002	±0.002	±0.006	±0.002	±0.006	±0.004
Transmission frequency tracking (dB)	±0.002	±0.002	±0.002	±0.006	±0.002	±0.006	±0.004
Isolation (dB)	>100	>90	>90	>80	>90	>80	>80

*1: At 23 ±3°C using the offset short calibration method with a sliding load or LRL calibration method (as noted) to achieve 12-term error correction.

Ordering information

Please specify model/order number, name and quantity when ordering.

Model/Order No.	Name
37147C	Main frame Vector Network Analyzer (22.5 MHz to 20 GHz)
37169C	Vector Network Analyzer (22.5 MHz to 40 GHz)
Option 1	Options (for VNA) Rack mounting with track slides
Option 1A	Rack mounting
Option 2A	High-speed time (distance) domain capability
Option 4	External SCSI-2 hard disk drive compatibility
Option 13	Delete internal source
3735B	Millimeter wave test set Millimeter wave test set
3700C3	System console
Option 1	Options (for test set) Rack mount kit with track slides
Option 1A	Rack mount kit with handles
3740A-Q	Millimeter wave modules*1 Transmission/reflection module (33 to 50 GHz, WR-22)
3740A-V	Transmission/reflection module (50 to 75 GHz, WR-15)
3740A-E	Transmission/reflection module (60 to 90 GHz, WR-12)
3740A-EE	Transmission/reflection module (56 to 94 GHz, WR-12)
3740A-W	Transmission/reflection module (75 to 110 GHz, WR-10)
3740A-EW	Transmission/reflection module (65 to 110 GHz, WR-10)
3740A-F	Transmission/reflection module (90 to 140 GHz, WR-8)
3741A-Q	Transmission only modules (33 to 50 GHz, WR-22)
3741A-V	Transmission only modules (50 to 75 GHz, WR-15)
3741A-E	Transmission only modules (60 to 90 GHz, WR-12)
3741A-EE	Transmission only modules (56 to 94 GHz, WR-12)
3741A-W	Transmission only modules (75 to 110 GHz, WR-10)
3741A-EW	Transmission only modules (65 to 110 GHz, WR-10)
3741A-F	Transmission only modules (90 to 140 GHz, WR-8)
MG3692A	Synthesizers*2 Synthesized CW generator, 2 to 20 GHz
MG3693A	Synthesized CW generator, 2 to 30 GHz
MG3694A	Synthesized CW generator, 2 to 40 GHz
Option 1	Options (for signal source) Rack mount kit with track slides
Option 1A	Rack mount kit with handles
Option 11	0.1 Hz frequency resolution
Option 14	VNA console mounting
Option 15A*2	High power output
Option 17B	Delete front panel
3655Q	Calibration kits*3 WR-22 Waveguide (33 to 50 GHz)
Option 1	Adds sliding termination
3655V	WR-15 Waveguide (50 to 75 GHz)
Option 1	Adds sliding termination
3655E	WR-12 Waveguide (60 to 90 GHz)
Option 1	Adds sliding termination
3655W	WR-10 Waveguide (75 to 110 GHz)
Option 1	Adds sliding termination
3655F	WR-8 Waveguide (90 to 140 GHz)
Option 1	Adds sliding termination

*1: The millimeter wave VNA requires that at least one of the two modules is a transmission/reflection type.

*2: One of the synthesizers must have Option 15A for millimeter wave operation.

*3: Consisting of: Short, fixed (2 each)
Shim, 1/4 wavelength and 3/8 wavelength
Termination, fixed (2 each)
Test port section (2 each)

BROADBAND VECTOR NETWORK ANALYZER

ME7808A

40 MHz to 110 GHz

Broadband S-Parameter Measurements to 110 GHz

NEW

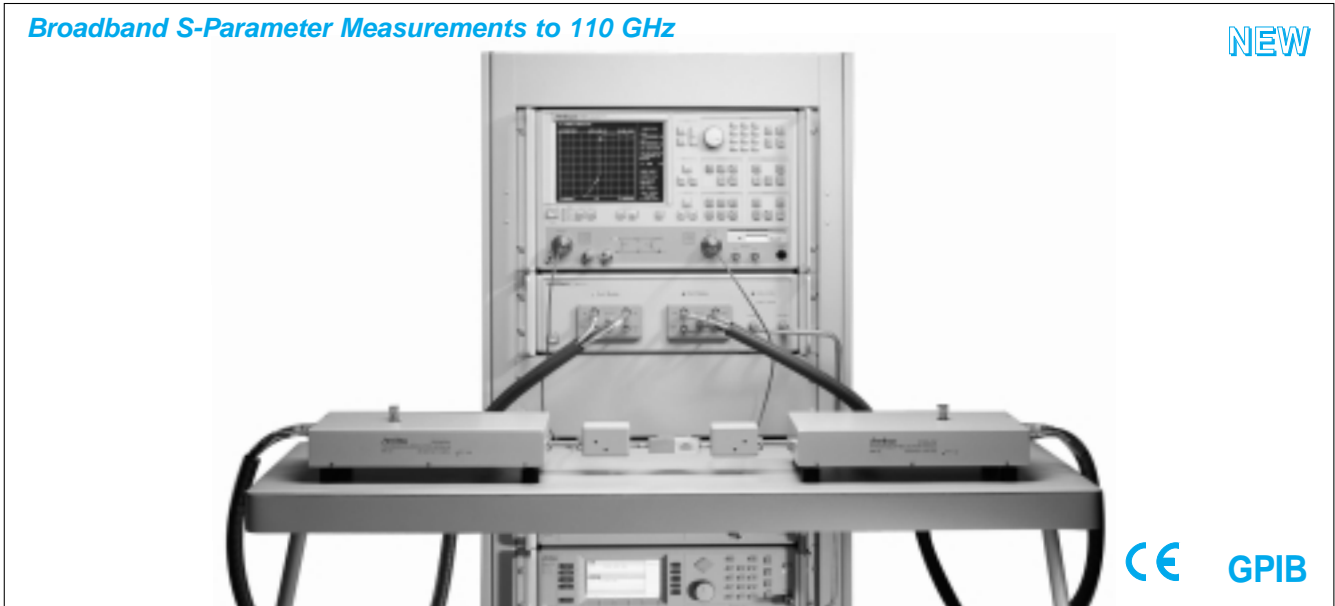

CE **GPIB**

The ME7808A Broadband Vector Network Analyzer (VNA) is a high performance measurement solution that covers 40 MHz to 110 GHz in a single fast sweep. In contrast to the millimeter wave Vector Network Analyzer, the ME7808A is built on the advanced technology of the Lightning 65 GHz VNA, and extends its advanced features and intuitive user interface to 110 GHz.

The configuration for the Broadband VNA consists of:

- Lightning 65 GHz VNA
- Millimeter-Wave Modules (Extended W Band, 65 GHz to 110 GHz)
- Broadband Test Set
- Frequency Sources
- Multiplexing Couplers
- Equipment Console with table

Features

• Measurement Speed and Accuracy

The Broadband VNA, based on our popular Lightning 37397C platform, offers the fastest measurement speed available. Measurement speed of approximately 1.5 seconds for a 101 point sweep means faster characterization of your millimeter wave and broad frequency devices. The ME7808A also offers full auto-reversing, 12-term, error-corrected S-parameter measurements with advanced calibration techniques – such as Short-Open-Load-Thru (SOLT), Line-Reflect-Line (LRL), and Line-Reflect-Match (LRM) – ensuring maximum accuracy in your on-wafer measurements. For waveguide measurements, the ME7808A system supports all of the above methods as well as the offset short calibration technique. The 8.5 inch, color liquid crystal display (LCD) allows users to easily view the data traces for all four S-parameters while simultaneously displaying limit lines and trace memory functions. The built-in 3.5 inch MS-DOS® compatible floppy disk drive and internal hard disk drive simplify the procedure of storing and recalling calibrations, front panel setups, and measurement data. The versatility of the Lightning platform allows data to be gathered using the *.s2p, *.txt, *.dat, *.bmp, *.hgl, and the *.wmf file format so data can be easily loaded into both circuit simulation and graphics programs.

• Single Pair of Coaxial Test Ports

The ME7808A Broadband VNA combines the 40 MHz to 65 GHz output from the VNA and the 65 GHz to 110 GHz output from the mmW modules using a unique multiplexing coupler design. The effective system test ports for broadband frequency coverage are two W1 (1.0 mm) coax connectors. The Anritsu W1 connector is compatible with the IEEE standard 1.0 mm connector. This design provides a DC path that permits bias injection from the VNA front panel bias inputs directly to the W1 coax test ports.

• Three Systems in One

The Broadband VNA system provides maximum versatility and can be used in any of the following configurations:

- 1) as a broadband VNA (40 MHz to 110 GHz) with W1 (1.0 mm) connector coaxial interface
- 2) as a stand-alone 65 GHz VNA with V-connector coaxial interface
- 3) as a millimeter-wave VNA (65 GHz to 110 GHz) with a WR-10 waveguide connector interface. Additional discrete mmW bands are easily supported by substituting other available mmW modules into the system.

This flexibility in measurement interface allows you to tailor the Broadband VNA to your exact measurement needs. When operating either the 65 GHz or mmW systems independently, higher output power and increased dynamic range are achievable. Wafer probe tips can be connected to any of the three interfaces to make on-wafer measurements.

• Complete Measurement Solutions

The Anritsu Broadband VNA is compatible with leading probe stations and probe tips for making on-wafer measurements. On-wafer calibration software such as SussCal from Karl Suss and WinCal from Cascade Microtech have built in drivers for the Anritsu VNA's and therefore can be used with the ME7808A. In addition, Anritsu also offers a complete list of accessories including coaxial calibration kits, waveguide calibration kits, on-wafer calibration substrates, W1 (1mm) coaxial and waveguide to coaxial adapters.

Specifications

Dynamic range (typical)

W1 Coaxial Port	Frequency (GHz)	0.04	2	20	40	50	<65	>65	75	85	100	110	
	Max Signal into Port 2 (dBm)	30	30	30	30	30	30	30	16	14	13	12	12
	Port 1 Power, Typical (dBm)	-1	3	-7	-14	-10	-12	-14	-14	-10	-11	-9	-11
	Noise Floor (dBm)	-76	-103	-92	-88	-79	-67	-65	-65	-78	-81	-78	-73
	System Dynamic Range (dB)	75	106	85	74	69	55	51	68	70	69	62	62
	Receiver Dynamic Range (dB)	106	133	122	118	109	97	81	92	94	90	85	85

On Wafer	Frequency (GHz)	0.04	2	20	40	50	<65	>65	75	85	100	110	
	Max Signal into Port 2 (dBm)	30	30	30	30	30	30	18	17	16	16	16	16
	Port 1 Power, Typical (dBm)	-1	3	-8	-16	-12	-14	-16	-13	-14	-13	-13	-15
	Noise Floor (dBm)	-76	-103	-91	-86	-77	-65	-63	-75	-78	-74	-74	-69
	System Dynamic Range (dB)	75	106	83	70	65	51	47	62	64	61	54	54
	Receiver Dynamic Range (dB)	106	133	121	116	107	95	81	92	94	90	85	85

V Coaxial Port	Frequency (GHz)	0.04	2	20	40	50	65
	Max Signal into Port 2 (dBm)	30	30	30	30	30	30
	Port 1 Power, Typical (dBm)	0	5	-2	-7	-2	-2
	Noise Floor (dBm)	-77	-105	-97	-95	-87	-77
	System Dynamic Range (dB)	77	110	95	88	85	75
	Receiver Dynamic Range (dB)	107	135	127	125	117	107

WR-10 Waveguide	Frequency (GHz)	65	75	85	100	110
	Max Signal into Port 2 (dBm)	8	8	8	8	8
	Port 1 Power, Typical (dBm)	-6	-4	-6	-5	-7
	Noise Floor (dBm)	-73	-84	-86	-82	-77
	System Dynamic Range (dB)	67	80	80	77	70
	Receiver Dynamic Range (dB)	81	92	94	90	85

System dynamic range is defined as the ratio of the typical power at Port 1 and the system noise floor. The noise floor measurement is made using 512 averages in a 100 Hz IF bandwidth, including isolation calibration.

Measurement time for 101 data points (typical)

Frequency Span	40 MHz to 110 GHz
Time (s)	1.5

Measurement time is based on a single 40 MHz to 110 GHz sweep with 10 kHz IF bandwidth (no averages) after full 12-term calibration. Sweep time includes retrace and band switch times.

Ordering information

Please specify model/order number, name, and quantity when ordering.

Model/Order No.	Name
ME7808A	Main frame Broadband Vector Network Analyzer (includes 3742A-EW*1 millimeter wave modules, broadband test set, frequency sources, multiplexing couplers, and an equipment console for 40 MHz to 110 GHz functionality)
Option 14	Options Split-Band (Microwave/mmW) VNA, replaces 65 GHz (37397C) with 50 GHz (37377C) VNA, deletes multiplexing coupler and 65 to 110 GHz mmW modules. Select desired mmW modules separately.
3740A-V	Optional Millimeter-wave modules Transmission/Reflection Module, 50 to 75 GHz
3740A-E	Transmission/Reflection Module, 60 to 90 GHz
3740A-EE	Transmission/Reflection Module, 56 to 94 GHz
3740A-EW	Transmission/Reflection Module, 65 to 110 GHz
3740A-W	Transmission/Reflection Module, 75 to 110 GHz
3740A-F	Transmission/Reflection Module, 90 to 140 GHz
806-101	Test Port Cables Flexible, V female to V male
3670V50-2	Semi-rigid, V female to V male
*2	Semi-rigid, W1 male to W1 male

Model/Order No.	Name
3654B	Calibration Kits V-connector calibration kit with sliding terminations
3655W	WR-10 waveguide calibration kit
3655W-1	WR-10 waveguide calibration kit with sliding terminations
*2	Adapters (coaxial) W1 male to V male
*2	W1 male to V female
*2	W1 female to V male
*2	W1 female to V female
*2	W1 male to W1 male
*2	W1 male to W1 female
*2	W1 female to W1 female
*2	Adapters (waveguide to coaxial) WR-10 to W1 male
*2	WR-10 to W1 female
110H	On-Wafer Test Probes and Substrates (GGB Picoprobe®) 110 GHz wafer probe, W1 female
67A	67 GHz wafer probe, V female
120 w/out Bias T	Extended W band wafer probe, WR10
120 w/ Bias T	Extended W band wafer probe, WR10, with bias tee
CS5	Calibration substrate

*1: 3742A-EW modules are equipped with an adjustable attenuator that is not available in the 3740A.

*2: Contact factory to place an order for the item.

VECTOR NETWORK ANALYZER AUTOMATIC CALIBRATOR

3658 Series

10 MHz to 40 GHz

Automatic, High-Reliability, and High-Quality Calibrators for Coaxial Device Measurements



The 3658 series AutoCal[®] modules are automatic calibrators that provide fast, repeatable, and high-quality coaxial calibrations up to 40 GHz. These modules contain precisely characterized calibration standards that aid in the removal of normal systematic errors when using vector network analyzers (VNAs). AutoCal[®] is available in five models: 0.04 to 18 GHz, with N (m) to N (f) connectors, 0.01 to 6 GHz and 0.04 to 20 GHz, with K (m) to K (f) connectors, and 0.04 to 40 GHz, with K (m) to K (f) connectors.

AutoCal[®] modules come with a data file characterizing each standard in the calibrator module. Each module is guaranteed to perform to its specifications for 6 months without re-characterization. Following this period, re-characterization can be performed by the customer, or by sending the module to the nearest service center.

Test port cable converter sets aid the user in calibrating a VNA for testing non-insertable devices and devices with SMA or 3.5 mm connectors. Test port converter sets are available for K Connector[®], SMA, and 3.5 mm connectors. Adapter removal calibration is required for N type non-insertable device testing.

AutoCal[®] has a direct serial interface to the 37xxx and MS462x series of Anritsu vector network analyzers. The control software is built-in to the VNA. For operation with the 360B and/or older generation 37xxx models, an external PC running Microsoft Windows[®] with a National Instruments IEEE488.2 GPIB interface card is required.

Features

• **Calibration types**

1-port S₁₁ and S₂₂ calibration, and full 2-port, 12-term OSLT calibrations can be performed with AutoCal[®].

• **True thru**

Inherently, the internal calibrator thru is not as accurate as an external direct thru connection. The true thru mode offers the choice of manually removing the AutoCal[®] module for a true thru calibration.

• **Isolation cal**

Isolation cal is offered as part of a full 2-port calibration. The user is given the option of skipping isolation, using the default averaging factor during isolation, or entering a custom averaging factor.

• **Switch averaging**

The mechanical module uses an electromechanical switch to select the calibration standards. Switch averaging is offered to reduce the effects of the electromechanical switch's non-repeatability. A 6 dB reduction of non-repeatability can be achieved by increasing switch averaging by a factor of four, at the expense of the overall calibration time.

• **Thru update**

Due to cable movements and aging, periodically updating the thru portion of a full, 12-term calibration is recommended. Thru update mode offers the choice of simply performing a direct manual thru step to update a current calibration. This is easily performed without having to invoke the AutoCal[®] module.

• **Manual control**

Manual control offers the ability to connect any of the internal standards to the test ports of the VNA. This feature could be used to manually verify a calibration.

• **Adapter removal**

VNA calibration for testing non-insertable devices, requires phase equal insertables. If this is not possible or is undesirable, adapter removal calibration is the solution. Adapter removal requires two full 12-term calibrations, moving an adapter from one test port cable to the other between calibrations (a job AutoCal[®] makes quick and easy). Internal software mathematically subtracts the effect of the adapter, yielding the desired adapterless measurement.

Specifications

All specifications are guaranteed over the ambient temperature range of 23° ±3°C.

• Directivity

Frequency	AutoCal [®] module	AutoCal [®] with 36583X
0.01 to 0.2 GHz	38 dB	36 dB
0.2 to 20 GHz	38 dB	36 dB
20 to 40 GHz	34 dB	32 dB

• Source match

Frequency	AutoCal [®] module	AutoCal [®] with 36583X
0.01 to 0.2 GHz	34 dB	32 dB
0.2 to 20 GHz	34 dB	32 dB
20 to 40 GHz	26 dB	24 dB

• Reflection tracking

Frequency	AutoCal [®] module	AutoCal [®] with 36583X
0.01 to 0.2 GHz	±0.15 dB	±0.20 dB
0.2 to 20 GHz	±0.20 dB	±0.25 dB
20 to 40 GHz	±0.25 dB	±0.30 dB

• Transmission tracking (Internal thru mode)

Frequency	AutoCal [®] module	AutoCal [®] with 36583X
0.01 to 0.2 GHz	±0.15 dB	±0.20 dB
0.2 to 20 GHz	±0.20 dB	±0.25 dB
20 to 40 GHz	±0.25 dB	±0.30 dB

• Transmission tracking (True thru mode)

Frequency	AutoCal [®] module	AutoCal [®] with 36583X
0.01 to 0.2 GHz	±0.10 dB	±0.15 dB
0.2 to 20 GHz	±0.10 dB	±0.15 dB
20 to 40 GHz	±0.20 dB	±0.25 dB

General

• Serial input connector

9 pin D-sub allowing PC or direct VNA control. (Serial cable supplied)

• Power supply input connector

+5 V, ±15 V for the electronic modules, and +5 V, +24 V for the electromechanical module. The modules are keyed against plugging the wrong supply. The appropriate DC supply is supplied with each AutoCal[®] module. These universal supplies will operate at either 110 V or 220 V input voltages.

• Power LED

On when the DC supply is plugged in.

• Operate LED

On when the module's internal temperature has stabilized at an optimum temperature for accurate calibrations.

• Dimensions

155 (W) x 65 (H) x 90 (D) mm (6 W x 2.5 H x 3.5 D in.)

Environment

• Operating temperature

18° to 28°C

• Storage temperature

-20° to 70°C

• Relative humidity

5% to 95% at 40°C

• EMC

Conforms to the EMC Directive, 89/336/EEC

Conducted and Radiated Emissions-
CISPR 11: 1990/EN55011: 1991,
Group 1 Class A

Immunity-

IEC 1000-4-2:1995/EN 50082-1: 1992,
4 kV CD, 8 kV AD

IEC 1000-4-3:1995/EN 50082-1: 1992,
3 V/m, 26-1000 MHz, 80% 1 kHz AM

IEC 1000-4-4: 1995/EN 50082-1: 1992,
.5 kV SL, 1 kV PL

Ordering information

Please specify model/order number, name, and quantity when ordering.

Model/Order No.	Name
36581NNF 36581KKF 36582KKF 36581NNF/1 36581KKF/1	Main frame AutoCal [®] (N type, 40 MHz to 18 GHz) AutoCal [®] (K type, 40 MHz to 20 GHz) AutoCal [®] (K type, 40 MHz to 40 GHz) AutoCal [®] (N type, 10 MHz to 6 GHz) AutoCal [®] (K type, 10 MHz to 6 GHz)
36583S 36583L 36583K	Test port converter sets SMA type 3.5 mm type K type
2300-228	Service Re-characterization software

AutoCal[®] may be sent to the nearest service center for re-characterization, or a service engineer may perform the task at the customer's site. With the aid of the re-characterization software, a Lightning or Scorpion family VNA, and a traditional cal kit, the customer can re-characterize his own AutoCal[®] module, minimizing downtime.

VNA AND VNMS Calibration Kits

For Performing Precise Calibrations of Vector Network Analyzers



3753LF



3651, Option 1

The Anritsu Calibration Kits contain all the precision components and tools required to calibrate your VNA or VNMS for 12-term error-corrected measurements in the connector style of your choice. Components are included for calibrating male and female test ports as required. The kits support calibration with opens, shorts, and broadband loads. Option 1 adds sliding terminations and a pin depth gauge where required.

The following kits are for use with 37XXX Lightning VNAs.

3650 SMA/3.5 mm Calibration Kit consisting of:

- 34ASF50-2 Female Adapter (2)
- 33FSF50 Female-Female Adapter (2)*
- 33SSF50 Male-Male Adapter*
- 28S50-2 B Male Termination (2)
- 28SF50-2 Broadband Female Termination (2)
- 33SSF50-Male-Female Adapter (2)*
- 24S50 Male Open
- 23SF50 Female Open
- 23S50 Male Short
- 23SF50 Female Short
- 34AS50-2 Male Adapter (2)
- Connector Thumb Wheel (4)
- 01-201 Torque Wrench
- 01-210 Reference Flat
- 01-222 Pin Depth Gauge
- 01-223 Pin Depth Gauge
- Calibration coefficients diskette

Option 1

Adds the following:

- 01-212 Female Flush Short
- 01-211 Male Flush Short
- 17SF50 Female Sliding Termination
- 17S50 Male Sliding Termination

3651 GPC-7 Calibration Kit consisting of:

- 28A50-2 Broadband Termination (2)
- 24A50 Open
- 23A50 Short
- 01-200 Torque Wrench
- 01-221 Collet Extractor Tool and 4 Collets
- Calibration coefficients diskette

* Phase Equal Adapters

Option 1

Adds the following:

- 17A50 Sliding Termination
- 01-210 Reference Flat
- 01-220 Pin Depth Gauge

3652 K Connector® Calibration Kit consisting of:

- 34AKF50-2 Female Adapter (2)
- 33KFF50 Female-Female Adapter (2)*
- 33KK50 Male-Male Adapter*
- 28K50-2 Male Termination (2)
- 28KF50-2 broadband Female termination (2)
- 33KKF50-Male-Female Adapter (2)*
- 24K50 Male Open
- 23KF50 Female Open
- 23K50 Male Short
- 23KF50 Female Short
- 34AK50-2 Male Adapter (2)
- 01-201 Torque Wrench
- 01-210 Reference Flat
- 01-222 Pin Depth Gauge
- 01-223 Pin Depth Gauge
- Calibration coefficients diskette
- Connector thumb wheel (4)

Option 1

Adds the following:

- 17KF50 Female Sliding Termination
- 17K50 Male Sliding Termination
- 01-212 Female Flush Short
- 01-211 Male Flush Short

3653 Type N Calibration Kit consisting of:

- 23NF50 Female Short
- 23N50 Male Short
- 24NF50 Female Open
- 24N50 Male Open
- 28N50-2 Broadband Male Termination (2)
- 28NF50-2B Broadband Female Termination (2)
- 34AN50-2 Male Adapter (2)
- 34ANF50-2 Female Adapter (2)
- 01-213 Reference Gauge
- 01-224 Pin Depth Gauge
- Calibration coefficients diskette

3654B V Connector® Calibration Kit consisting of:

- 23V50B-5.1 Male Short 5.1mm
- 23VF50B-5.1 Female Short 5.1mm
- 24V50B Male Open
- 24VF50B Female Open
- 28V50B Male Broadband Termination (2)
- 28VF50B Female Broadband Termination (2)
- 17VF50B Female Sliding Termination
- 17V50B Male Sliding Termination
- 33VV50 Male-Male Adapter*
- 33VVF50 Female-Female Adapter (2)*
- 33VVF50 Male-Female Adapter (2)*
- Calibration coefficients diskette
- Connector thumb wheel (4)
- 01-201 Torque Wrench
- 01-210 Reference Flat
- 01-322 Pin Depth Gauge
- 01-323 Female Adapter for pin gauge
- 01-204 Adapter Wrench
- 01-312 Male Flush Short
- 01-311 Female Flush Short

3655 Waveguide Calibration Kit

The 3655 Calibration Kit contains all of the precision components and tools required to calibrate your VNA for 12-term error-corrected measurements of test devices with the appropriate waveguide designation. Components are included for calibrating both module ports. The kit supports calibration with offset shorts and broadband loads. Option 1 adds a sliding termination.

Consisting of:

- Short, Flush (2)
- Offsets, 1/8 and 3/8 Wavelength
- Terminations, Fixed (2)
- Test Port Sections (2)

Option 1

Adds the following:

- Sliding Termination

3750 SMA/3.5 mm Calibration Kit consisting of:

- 23LF50 Female Short
- 23L50 Male Short
- 24LF50 Female Open
- 24L50 Male Open
- 28L50 Male Termination (2)
- 28LF50 Female Termination (2)
- Calibration coefficients diskette

3751 GPC-7 Calibration Kit consisting of:

- 23A50 Short
- 24A50 Open
- 28A50 Termination (2)
- Calibration coefficients diskette

Option 1

Adds the following:

- 28A50LF 3rd Termination

3753 Type N Calibration Kit consisting of:

- 23NF50 Female Short
- 24NF50 Female Open
- 24N50 Male Open
- 28NF50 Female Termination (2)
- 28N50 Male Termination (2)
- 23N50 Male Short
- Calibration coefficients diskette

The following kits are for use with MS462XX Scorpion VNAs.

3750LF SMA/3.5 mm 6 GHz Calibration Kit consisting of:

- 23LF50 Female Short
- 23L50 Male Short
- 24LF50 Female Open
- 24L50 Male Open
- 28L50LF Male Termination (2)
- 28LF50LF Female Termination (2)
- Calibration coefficients diskette

3751LF GPC-7 6 GHz Calibration Kit consisting of:

- 23A50 Short
- 24A50 Open
- 28A50LF Termination (2)
- Calibration coefficients diskette

Option 1

Adds the following:

- 28A50LF 3rd Termination

3753LF Type N 6 GHz Calibration Kit consisting of:

- 23NF50 Female Short
- 24NF50 Female Open
- 24N50 Male Open
- 28NF50LF Female Termination (2)
- 28N50LF Male Termination (2)
- 23N50 Male Short
- Calibration coefficients diskette

Ordering information

Please specify model/order number, name and quantity when ordering.

Model/Order No.	Name
	Calibration kits
3650	SMA/3.5 mm calibration kit
Option 1	Adds sliding terminations
3651	GPC-7 calibration kit
Option 1	Adds sliding terminations
3652	K Connector® calibration kit
Option 1	Adds sliding terminations
3653	Type N calibration kit
3654B	V Connector® calibration kit with sliding terminations
3655	Waveguide calibration kit
Option 1	Adds sliding terminations
3750	SMA/3.5 mm 8.6 GHz calibration kit
3750LF	SMA/3.5 mm 6 GHz calibration kit
3751	GPC-7 8.6 GHz calibration kit
3751LF	GPC-7 6 GHz calibration kit
3753	Type N 8.6 GHz calibration kit
3753LF	Type N 6 GHz calibration kit
3753-75	75 Ohm Type N 3 GHz calibration kit

* Phase Equal Adapters

VNA AND VNMS Verification Kits

For Confirming Accuracy of Vector Network Analyzers



3669B

The Anritsu Verification Kits contain precision components with characteristics that are traceable to NIST. Used primarily by the metrology laboratory, these components provide the most dependable means of determining the system accuracy of your VNA. A disk containing factory measured test data for all components is supplied for comparison with customer-measured data.

The following kits are for use with 37XXX Lightning VNAs.

3663 Type N Verification Kit consisting of:

- 42N-50, 50 dB Attenuator
- 18N50-10, 10 cm Airline
- 42N20, 20 dB Attenuator
- 18N50-10B, 10 cm Stepped Impedance Airline (Beatty standard)
- Verification kit disks

3665 Waveguide Verification Kit consisting of:

- Straight section
- Pin set
- Mismatch section
- Ball driver
- 50 dB Attenuator
- 20 dB Attenuator
- Verification kit disks

3666 SMA/3.5 mm Verification Kit consisting of:

- 19S50-7, 7.5 cm Airline
- 19SF50-7B, 7.5 cm Stepped Impedance Airline (Beatty standard)
- 42S-50, 50 dB Attenuator
- 42S-20, 20 dB Attenuator
- Verification kit disks

3667 GPC-7 Verification Kit consisting of:

- 42A-50, 50 dB Attenuator
- 18A50-10, 10 cm Air line
- 42A-20, 20 dB Attenuator
- 18A50-10B, 10 cm Stepped Impedance Airline (Beatty standard)
- Verification kit disks

3668 K Connector® Verification Kit consisting of:

- 19K50-7, 7.5 cm Airline
- 42K-50, 50 dB Attenuator
- 42K-20, 20 dB Attenuator
- 18K50-7B, 7.5 cm Stepped Impedance Airline (Beatty standard)
- Verification kit disks

3669B V Connector® Verification Kit consisting of:

- 42V-40, 40 dB Attenuator
- 42V-20, 20 dB Attenuator
- 19V50-5, 5 cm Airline
- 18V50-5B, 5 cm Stepped Impedance Airline (Beatty standard)
- Verification kit disks

The following kits are for use with MS462XX Scorpion VNAs.

3663LF Type N 6 GHz Verification Kit consisting of:

- 42N-50, 50 dB Attenuator
- 42N20, 20 dB Attenuator
- 42NOP-20 N Mismatch attenuator
- Verification kit disks

3666LF SMA/3.5 mm 6 GHz Verification Kit consisting of:

- 42L-50, 50 dB Attenuator
- 42L-20, 20 dB Attenuator
- 42LOP-20 SMA/3.5 mm Mismatch Attenuator
- Verification kit disks

3667LF GPC-7 6 GHz Verification Kit consisting of:

- 42A-50, 50 dB Attenuator
- 42A-20, 20 dB Attenuator
- 42AOP-20 GPC-7 Mismatch Attenuator
- Verification kit disks

Ordering information

Please specify model/order number, name and quantity when ordering.

Model/Order No.	Name
	Verification kits
3663	Type N verification kit
3665	Waveguide verification kit
3666	SMA/3.5 mm verification kit
3667	GPC-7 verification kit
3668	K connector® verification kit
3669B	V connector® verification kit
3663LF	Type N 6 GHz verification kit
3666LF	SMA/3.5 mm 6 GHz verification kit
3667LF	GPC-7 6 GHz verification kit

NETWORK ANALYZER 54100A Series 1 MHz to 110 GHz

Fast and Accurate Scalar Network Measurements, with Built-in Source

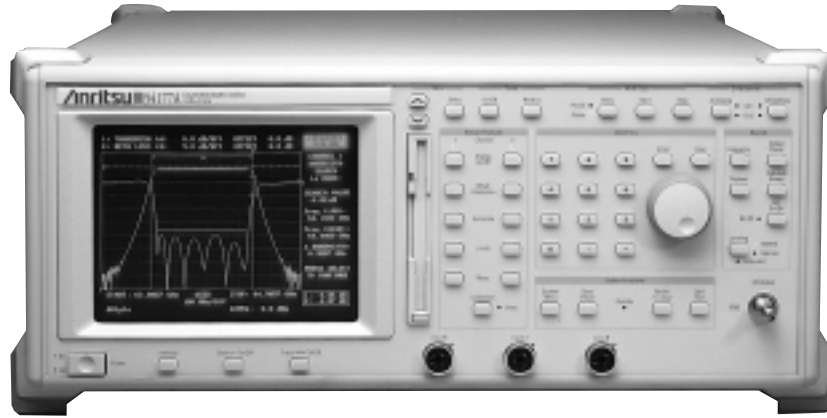

GPIB

7

54100A series Network Analyzers provide characterization of devices such as amplifiers, antennas, attenuators, adapters, RF bridges, duplexers, couplers, attenuators, cables, waveguide transmission lines, isolators, circulators, mixers, receivers, transceivers, up/down converters, multiplexers, power dividers, VCOs, switches, and filters. Advanced hardware and software features speed productivity and improve accuracy. Speed tuning processes with automated bandwidth search functions. Fast recall mode quickly steps through test procedures and sophisticated limit line controls quickly identify conformance to specifications. Low source harmonics and high directivity SWR autotesters assure accuracy.

Features

- Fast, accurate measurement of transmission, return loss, precision return loss, SWR, group delay, absolute power, and distance-to-fault
- Crystal-based source for exceptional stability and accuracy
- Built-in automation features including distance-to-fault
- Built-in floppy disk drive
- Rugged, reliable chassis
- **Transmission gain (loss), group delay and power measurements**
The basic configuration requires a single detector. For very low transmission loss devices (<0.25 dB), a second detector should be used to monitor any source power variations.

• Transmission and return loss (or SWR)

Return loss or standing wave ratio (SWR) measurements require a high directivity SWR autotester to separate the incident signal from the RF sweep source and reflected signal from the device under test. The configuration below will simultaneously display transmission and return loss characteristics.

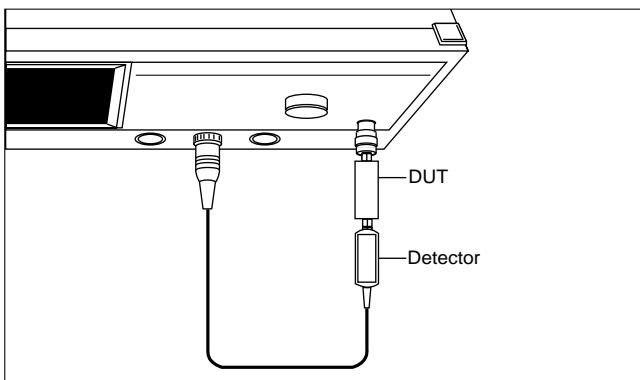
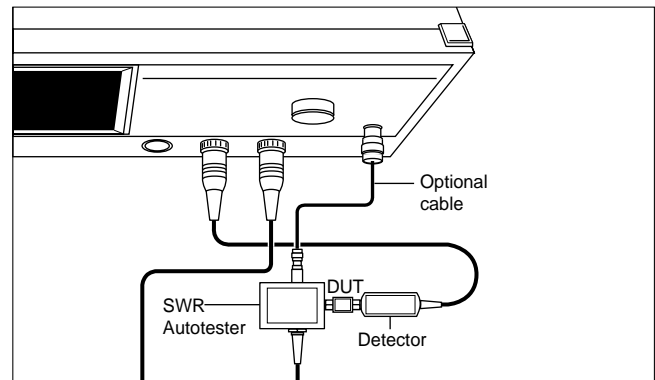

• Adapters, attenuators, terminations, couplers, RF bridges

The 54100A series precision return loss mode measures high return loss devices accurately traceable to NIST. The measurement system uses an offset SWR autotester and a precision airline — a physical impedance standard. Additionally, by exchanging the offset SWR autotester with a 20 dB offset termination, the directivity of couplers and RF bridges is displayed directly on the 54100A.

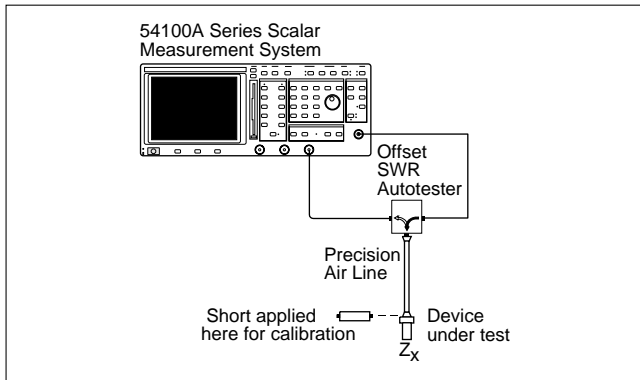

Distance-to-fault

The 54100A's optional distance-to-fault software accurately verifies transmission line and antenna system performance during installation, link/site commissioning, and at regular maintenance intervals. Transmission lines are typically the most common failure point in an antenna system. Finding the problem connectors, cables, and antennas before a complete failure occurs saves down-time and expense. Faulty antenna systems and transmission lines are easily diagnosed. A wide variety of coaxial and waveguide types are supported with standard catalog components.

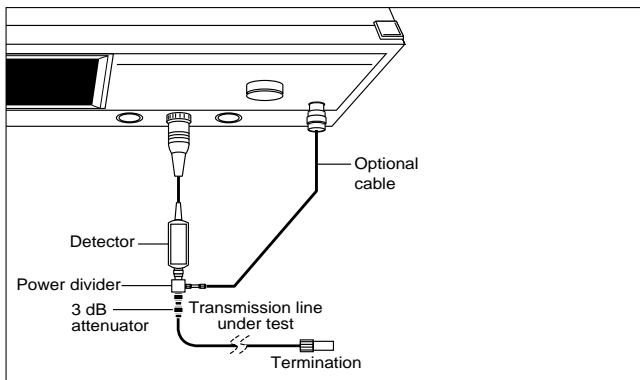

Common causes of antenna feed problems

• Cable and waveguide problems

- Cable discontinuities
- Moisture
- Braid wire ground shield fault (appears as a notch filter)
- Damaged/cut ground shields
- Dielectric fault or narrowed dielectric diameter
- Fasteners pinch cables

• Connector problems

- Corroded connectors
- Low quality connectors
- Connector pin offset (poor mating contact)

• Antenna problems

- Antenna out of specification
- Antenna storm/shipping damage

Performance

• Preventing “ghost” faults

The 54100A uses a low harmonic source and high performance anti-aliasing software to prevent the display of false or “ghost” transmission line faults. This is a common problem when the end of the DUT is unterminated or damaged. Anritsu's precision components and low harmonic sources prevent “ghost” faults, assuring accurate, repeatable results.

• High dynamic range

The 54100A distance-to-fault software optimizes sensitivity and accuracy. For example, a precision termination is used during calibration to achieve industry leading dynamic range. If the termination is not of high quality, it will reflect some of the source energy rather than absorb it—causing errors in the measurement process. The use of a specialized discrete fourier transform rather than a more common fast fourier transform also improves low level sensitivity. Low source harmonics also ensure that fault indications are actual transmission line and not re-reflections of source harmonic energy.

Relative group delay

Optional relative group delay software identifies signal distortion caused by bandpass devices such as filters, receivers, power amplifiers, and up/down converters. Group delay is a key cause of high bit error rate (BER). Group delay is important for (1) CDMA and spread spectrum communications, (2) phase array radars, (3) high capacity satellite and terrestrial microwave links, and (4) PAL and HDTV television components and other RF systems sensitive to phase distortion. The 54100A saves time and expense by eliminating several pieces of expensive test equipment – combining the capabilities into a single, low cost test station. Manufacturing processes save re-test/re-tuning time by utilizing a single 54100A instead of two separate tuning stations – one for scalar transmission and return loss and the other for relative phase group delay. Furthermore, the 54100A can accurately test frequency conversion devices without the wideband reference converters required with vector network analyzers or microwave system analyzers.

Convertible SWR autotester

Convertible SWR autotesters reduce capital equipment and maintenance costs. A single convertible SWR autotester accurately measures the return loss or SWR of devices with SMA, 3.5 mm, or K connectors. Six interchangeable test port heads (male and female for each connector standard) are precision tuned to the convertible SWR autotester's internal bridge circuit.



The 560-98C50 Convertible SWR Autotester improves test accuracy and reduces maintenance cost without using error prone test port adapters or connector savers.

The inexpensive test port heads save repair and calibration costs because they are interchangeable.

Measurement accuracy

• Transmission loss or gain measurement accuracy

Uncertainties from the frequency response of components are automatically subtracted from test data during the path calibration procedure. Overall accuracy is then:

$$\begin{aligned} &\text{Channel accuracy} \\ &+ \text{Mismatch uncertainty} \\ &+ \text{Distortion from source harmonics} \\ &\hline &\text{Transmission measurement accuracy} \end{aligned}$$

Effects of source, test device, SWR autotester, and detector mismatch can be significant. This mismatch uncertainty is minimized by the exceptionally low reflection characteristics of Wiltron's detectors, sources, and SWR autotesters. Anritsu's ultra low source harmonics maximize the accuracy.

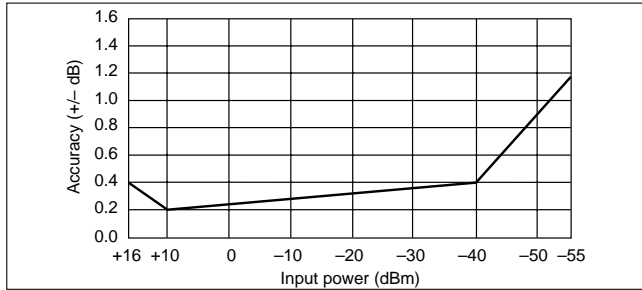

Channel accuracy (25°C)

• Distortion from source harmonics

Poor source harmonics cause large measurement errors. If the sweep range is set wide enough, at some point during the sweep, the harmonic will pass through the filter's pass band. Since the transmission detector is a broadband diode, the harmonic's signal power is measured. Thus, the analyzer displays the response of the harmonic in addition to the fundamental sweep frequency.

• Bandpass filter, distortion from source harmonics

If the source has a -30 dBc second harmonic and a -35 dBc third harmonic, at the beginning of the sweep, the harmonics pass through the filter's passband.

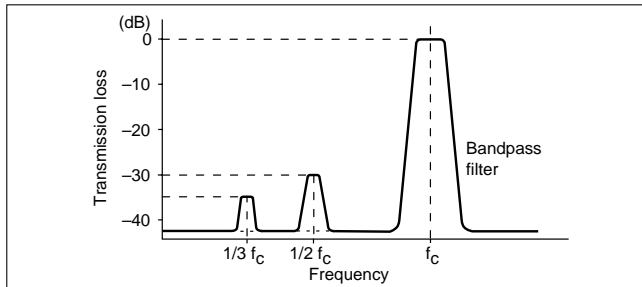

• Highpass filter, distortion from source harmonics

A highpass (or wide bandpass) filter responds similarly to the bandpass filter, except the presence of the harmonic in the filter's pass band limits the useful dynamic range of the analyzer.

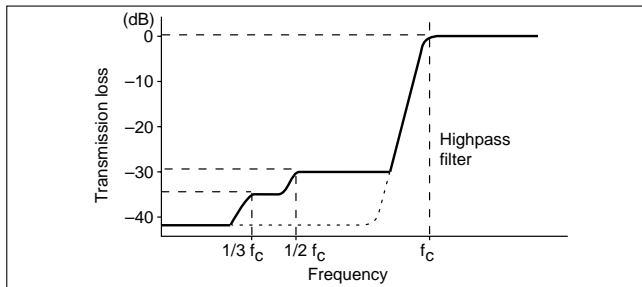

Return loss measurement accuracy

Uncertainties resulting from SWR autotester and source frequency response and from system open and short characteristics are subtracted automatically from test data. Overall accuracy is then:

$$\begin{aligned} &\text{Channel accuracy} \\ &+ \text{Autotester accuracy} \\ &+ \text{Distortion from source harmonics} \\ &\hline &\text{Return loss measurement accuracy} \end{aligned}$$

Autotester accuracy is composed of error due to directivity and error due to test port match. Unless the DUT has very poor return loss (high SWR), test port match will be negligible. When an adapter is used at the test port, use effective directivity to determine possible errors.

• Return loss accuracy due to directivity

Improved directivity decreases SWR (or return loss) measurement errors. The chart below identifies maximum error due to directivity.

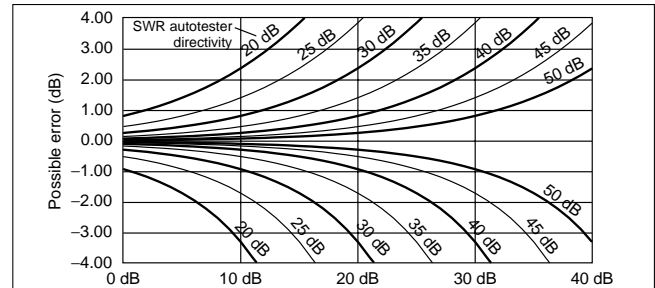

• Return loss accuracy due to effective directivity

Effective directivity is the reduction to directivity due to a test port adapter's SWR performance. Adapters severely degrade measurement directivity. The chart below shows the maximum degradation to a 40 dB directivity SWR autotester caused by test port adapters of varying quality.

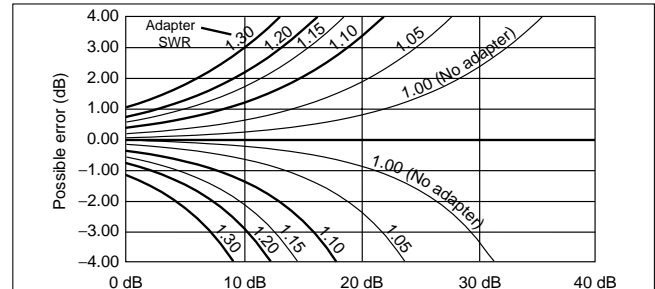

• Return loss accuracy due to source harmonics

Source harmonics are a significant source of return loss measurement uncertainty when testing banded devices such as filters, receivers, transmitters, power amplifiers, and antennas. In many cases, the harmonic errors are larger than uncertainty due to directivity, which is typically assumed to be the largest uncertainty factor.

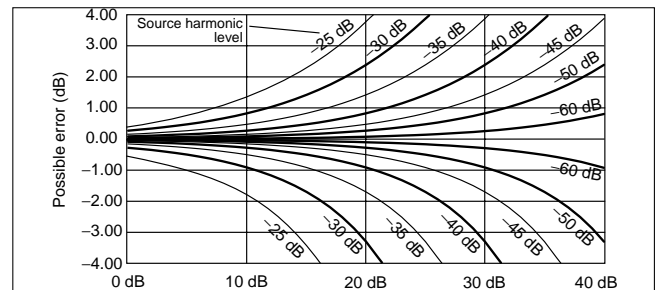

This chart assumes full reflections of a single source harmonic at the DUT input. Multiple harmonics can cause additional measurement uncertainty.

Specifications

Analyzer	Measurement modes	Transmission (dB), return loss (dB), SWR (linear SWR), optional group delay (ns), power (dBm) precision return loss (dB) and optional distance-to-fault
	Dynamic range	-55 to +16 dBm, autozeroing with DC detection
	Inputs	Three, two standard inputs, A and B, with optional third reference channel, R (Option 5)
	Display channels	Two channels are used to select and simultaneously display any two inputs from A, B, or R. The inputs can also be displayed as ratios A/R or B/R.
	Scale resolution	0.1 to 10 dB(m) per division in 0.1 dB steps
	Cursor functions	Searches for trace maximum, minimum, dB level, dB bandwidth, next marker and active marker
	Averaging	2, 4, 8, 16, 32, 64, 128, or 256
	Limit lines	Two limit lines, either single value or multi level segmented, for each trace. Segmented lines may be made from up to 10 individually editable segments.
	Auto-zero	Performs an AC modulation cycle and low level calibration during sweeper retrace
	Save/Recall	Thirteen sets of front panel set-ups and thirteen sets of trace memory can be stored in non-volatile instrument memory.
	Trace mask	A swept frequency measurement can be stored to a graticule trace mask for visual comparison to later measurements.
	Disk drive	Built-in 3.5 inch, 1.44 MB floppy disk drive
Autosave	Automatically increments the trace data file name and reference number during successive data storage operations to the DOS disk	
Source	Frequency range	1 MHz to 110 GHz, model dependent
	Alternate sweep	Sweeps alternately between frequency ranges set differently for channel 1 and channel 2
	CW	Provides single frequency output (both channels turned off)
	Frequency resolution	RF Models (54107A, 54109A, 54111A): 10 kHz, Microwave models: 100 kHz
	Output power	Maximum guaranteed levelled output power is model dependent.
	Reverse power protection	Up to 5 Watts. Limited to 1 Watt with attenuator option
Application function	Min/Max hold	Save the minimum and maximum values of successive sweeps or the combination of the two
	Cursor functions	Automatic cursor search updates the bandwidth, minimum, or maximum levels of the displayed trace.
	Compression test automation	Determines the gain compression point over the operating frequency range of an amplifier by successively incrementing the source power and measuring the amount of compression until a preset "X" dB limit is exceeded.
	Self test	Performs a self test every time power is applied or when SELF TEST pushbutton is pressed. If an error is detected, a diagnostic code appears, identifying the cause and location of the error.
General	Operating temperature	0° to +50°C
	Power	115 V $\pm 10\%$, 230 V $\pm 10\%$, 48 to 400 Hz, 300 VA
	Mass	18 kg (39 lb.)
	Printer	Parallel printer interface is compatible with the Canon BJ85 and most Epson FX-compatible printers.
	Transit case	Hard shell case with custom foam inserts, PN: 760-183
	EMC	Meets European community requirements for CE marking

Ordering information

Please specify model/order number, name, and quantity when ordering.

Model/Order No.	Name
	Main frame
54107A	Scalar Measurement System (0.001 to 1.5 GHz)
54109A	Scalar Measurement System (0.001 to 2.2 GHz)
54111A	Scalar Measurement System (0.001 to 3.0 GHz)
54137A	Scalar Measurement System (2 to 20 GHz)
54147A	Scalar Measurement System (0.01 to 20 GHz)
54163A	Scalar Measurement System (2 to 40 GHz)
54169A	Scalar Measurement System (0.01 to 40 GHz)
54177A	Scalar Measurement System (0.01 to 50 GHz)

Model/Order No.	Name
	Options
Option 1	Rack mounting with slides
Option 2	70 dB RF step attenuator
Option 2A	70 dB, 20 GHz MW step attenuator
Option 2C	70 dB, 40 GHz MW step attenuator
Option 2D	70 dB, 50 GHz MW step attenuator
Option 4	75 Ω source output (available to 3.0 GHz)
Option 5	Add reference channel
Option 6	Add external levelling
Option 7	Internal distance-to-fault software
Option 8	Internal relative group delay software
Option 12	Add front panel cover
Option 13	Add front mounted handles
Option 16	+15 V DC supply for millimeter wave source modules (available with <20 GHz models only)
Option 25	Maintenance manual
Option 26	Extra operation and GPIB programming manual
Option 33	Canon printer

MILLIMETER WAVE MEASUREMENT SYSTEM

54000 Series

50 GHz to 110 GHz

Scalar Measurements to 110 GHz from an Integrated System

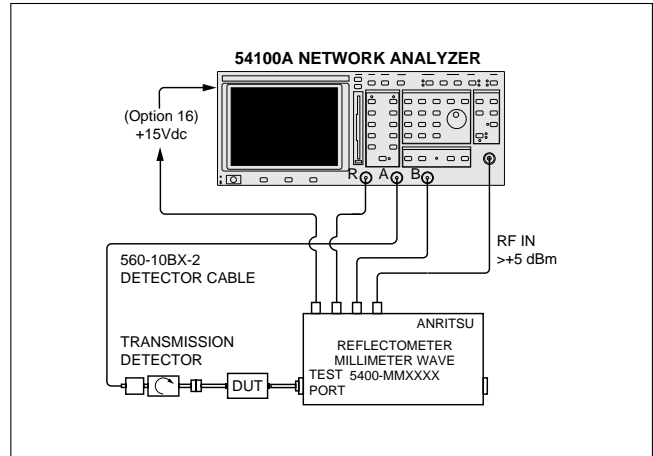

Millimeter wave reflectometer configuration

Excellent multiplier source match provided by the internal isolators and the improved detector return loss allow accurate, simultaneous return loss and transmission measurements.

Features

- Operates with standard 54147A analyzer
- 40 dB (typical) directivity for accurate SWR measurements
- Millimetric waveguide detectors for loss/gain measurements

The Anritsu's Millimeter Wave Reflectometers are designed to operate with the 54147A 20 GHz Network Analyzer. The milli-meter wave multiplier includes subharmonic filters and an isolator, to dramatically improve reflection accuracy.

Specifications

Reflection accuracy characteristics	Source match	<1.9 (<1.7 Typical)
	Directivity	35 dB (>40 dB Typical)
	Dynamic range	>56 dB
	Channel accuracy	Channel accuracy is degraded by ±0.4 dB from standard 54100A specifications
	Output power, minimum	Leveled or unleveled V-band: 0.0 dBm min. (+4.0 dBm Typ.) W-band: -5.0 dBm min. (+1.0 dBm Typ.)
	Power flatness, unleveled	±3.0 dB Typ.
	Required input frequency	V-band: 12.75 to 18.75 GHz, W-band: 12.75 to 18.33 GHz
	Required input harmonics	<-60 dBc
	Spurious signals	Harmonic: <-55 dBc (<-60 dBc Typical), Nonharmonic: <-55 dBc (<-60 dBc Typical)
	Frequency accuracy	Source dependent
Frequency resolution	Source dependent	
Millimeter reflectometer accessories	12" N (m) to N (m) RF input cable	PN: N120-12
	Precision attenuators	1.08: 1.0 SWR Precision loads and attenuators allow low insertion loss devices such as couplers and waveguide sections to be accurately tested. V band 3 dB: SM4784; 6 dB, SM4786 W band 3 dB: SM4785; 6 dB, SM4787
	Precision loads	1.06: 1.0 SWR V band, SM4782 W band, SM4783
	DC power connections	SM4819 Twinax (m) - Twinax (m) cable SM4816 Twinax to dual banana plug SM4818 Twinax to dual EZ hooks
Physical	Size	9.5 x 4.5 x 1.5 inches
mmWave	Maximum input power, damage level	+21 dBm

Special Waveguide Reflectometers (Reflectometers have integrated multipliers/amplifiers. Input frequency is < 20 GHz)					
Model	Frequency range	Directivity	Test port		Input connector
			SWR	Flange	
54000-6WR15	50 to 75 GHz	35 dB, 40 dB typ.	<1.9 (<1.7 typ.)	WR-15	N (f)
54000-6WR10	75 to 110 GHz	35 dB, 40 dB typ	<1.9 (<1.7 typ.)	WR-10	N (f)
Millimeter Wave Detectors					
Model	Frequency range	Dynamic range	Input port		Output connector
			Return loss	Flange	
54000-7WR15	50 to 75 GHz	> 56 dB typ.	17 dB	WR-15	BNC (f)
54000-7WR10	75 to 110 GHz	> 56 dB typ	17 dB	WR-10	BNC (f)

Ordering information

Please specify model/order number, name, and quantity when ordering.

Model/Order No.	Name
54000-6WR15	Millimeter Wave Module
54000-6WR10	Millimeter Wave Module
54000-7WR15	Millimeter Wave Module
54000-7WR10	Millimeter Wave Module

NETWORK ANALYZER
MS4630B
10 Hz to 300 MHz

For Fast Evaluation of IF Filters and Resonators



CE GPIB

7

The MS4630B is suitable for electronics production lines demanding fast and accurate device measurements. It is particularly well suited to accurate, high-speed evaluation of IF filter resonance and group delay characteristics, as well as evaluating the impedance characteristics of resonators in AV equipment and personal computers. A fast sweep speed of 150 μ s/measurement point is achieved using a high-speed synthesizer and digital signal processing (DSP) technologies. The post-processing data analysis functions have been strengthened with improved data-processing macros that have greatly increased the total production throughput. In comparison to the earlier MS3401A/B and MS3606B network analyzers, the sweep speed is three times faster and the group delay measurement accuracy and stability have been improved by more than 10 times. In addition, the dynamic range has been improved to 120 dB (RBW: 1 kHz) while the weight of the analyzer has been dramatically reduced. The GPIB and PTA processing speed are 30 to 50% faster than the MS4630A. In addition, the sweep conditions can be set more easily by the addition of the list sweep function.

Features

- High-speed evaluation of IF filters, resonators, etc.
- Greatly increased production/inspection capacity

Performance and functions

• High dynamic range

The high dynamic range of 120 dB (RBW: 1 kHz) permits fast and accurate out-of-band measurement of filter.

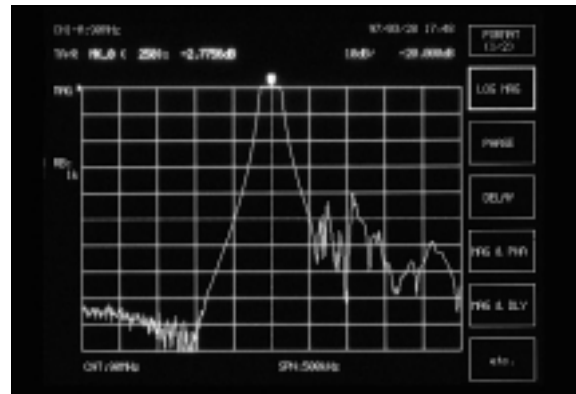

Filter out-of-band attenuation measurement

• Multi-marker function

Up to 10 markers can be set independently for each channel. The marker list function can be used to display all tabular data and waveform information simultaneously at each marker.

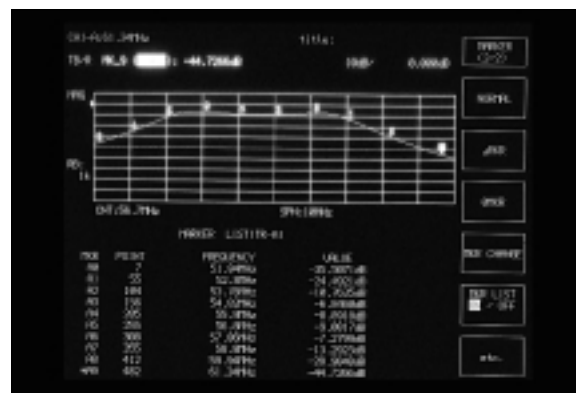

Multi-markers

- **High-accuracy group delay measurement**

The group delay characteristics can be measured with a high degree of accuracy at a resolution of 1/10,000 of the measurement range.

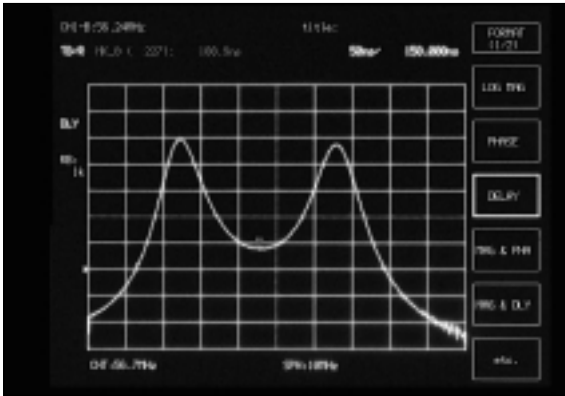

Group delay characteristics

- **Limit test function**

Device pass/fail evaluation can be performed in real-time using the single and segmented limit test functions.

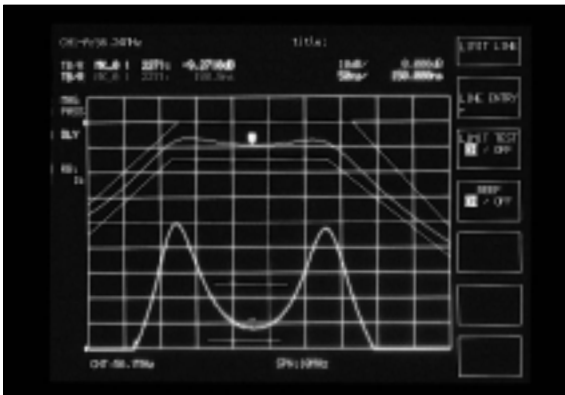

Filter pass/fail evaluation using limit test

- **Filter measurement**

Filter analysis functions

Filter characteristics such as 3 dB bandwidth, center frequency (f_0), in-band ripple, out-of-band attenuation, etc., are digitally processed and analyzed at high speed. User can easily enter or change default values using filter set up menu.

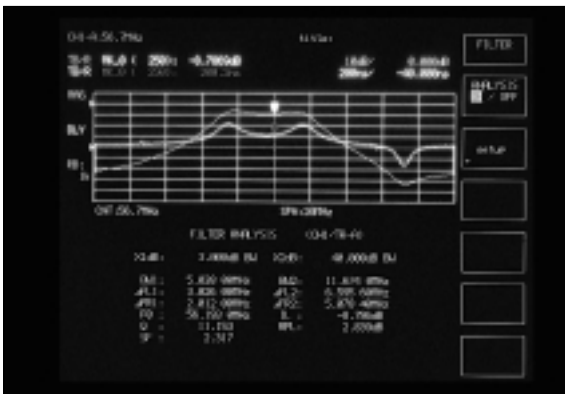

Measurement using filter functions

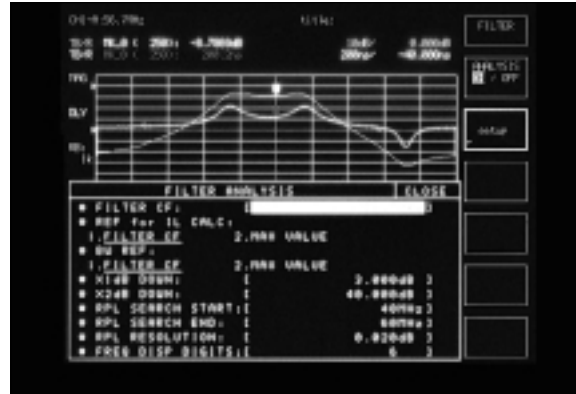

Set up menu for filter functions

- **Simultaneous in-band and spurious response data display**

Previously, spurious detection and passband measurement required switching of the measurement setup. The MS4630B alternate sweeping function permits simultaneous display of the measured passband and spurious band data. The very short switching time greatly improves the measurement efficiency.



Spurious measurement using alternate sweeping

- **Resonator measurement**

High-speed measurement of resonator characteristics

The MS4630B has a number of dedicated waveform analysis functions to improve the evaluation efficiency of resonators. Resonator 1 analyzes the resonance frequency (F_r) and the resonance impedance (Z_r). Resonator 2 is able to measure resonator equivalence in addition to the parameters for Resonator 1.

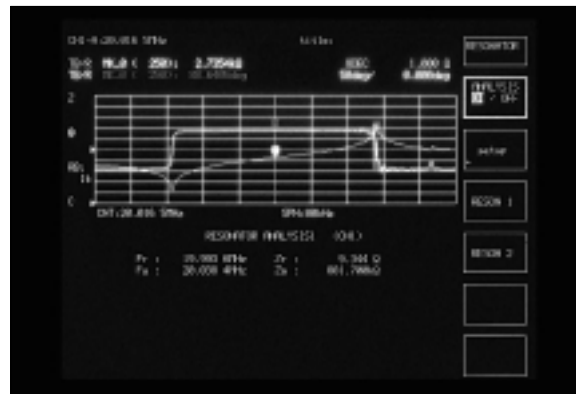

Resonator 1 measurement



Resonator 2 measurement

Specifications

Measurement items	Transmission characteristics (ratio measurement): Amplitude, phase, group delay Reflection/impedance characteristics: Amplitude, phase (with external transducer) Level characteristics: Absolute amplitude																					
Frequency	Range: 10 Hz to 300 MHz Resolution: 0.01 Hz Accuracy (standard) Aging rate: $\leq 1 \times 10^{-6}$ /day (15 minutes after power-on) Temperature characteristics: $\leq \pm 5 \times 10^{-6}$ (0° to 50°C) Accuracy (Option 13: High-stability reference oscillator) Aging rate: $\leq \pm 2 \times 10^{-9}$ /day (24 h after power-on) Temperature characteristics: $\leq \pm 5 \times 10^{-8}$ (0° to 50°C)																					
Input	Channel No. Standard: 2 (R, TA); Option 12: 3 (R, TA, TB) Impedance: 50 Ω, 1 MΩ switchable (when combined with MA4605A: 75 Ω, 1 MΩ) Input range (IRG): 0/+20 dBm Max. input power AC: +20 dBm; DC: ± 2.2 V (50 Ω) AC: 0 dBm; DC: ± 20 V (1 MΩ) Connector: BNC-J Probe source: +12 \pm 1 V, 100 mA (with protective circuit for shorts)																					
Average noise level	≤ -120 dBm (RBW: 1 kHz, 1 to 300 MHz), ≤ -110 dBm (RBW: 1 kHz, 80 kHz to 1 MHz)																					
Crosstalk	Between channels: ≥ 120 dB (80 kHz to 300 MHz), ≥ 110 dB (up to 80 kHz) Between transmitter and receiver: ≥ 125 dB																					
Resolution bandwidth	3, 10, 30, 100, 500 Hz, 1, 2, 3, 4, 5, 10, 20 kHz and automatic setting																					
Output	Output level range Output A: 0 to +21 dBm; Option 10: -70 to +21 dBm Output B: -6 to +15 dBm (-9.5 to +11.5 dB when Option 14 added); Option 10: -76 to +15 dBm (-79.5 to +11.5 dB when Option 14 added) Output resolution: 0.01 dB Output level accuracy: $\leq \pm 1.0$ dB (frequency: 100 MHz, Output A: +10 dBm) Output level linearity: $\leq \pm 0.5$ dB (0 dBm reference, frequency: 100 MHz, Output A: 0 to +21 dBm) Output level deviation: $\leq \pm 1.5$ dB (output A: +10 dBm, 100 MHz reference) Step error: ± 0.5 dB (Option 10) Output impedance: 50 Ω (when combined with MA4605A: 75 Ω) Connector: BNC-J																					
Amplitude measurement	Measurement range: ≥ 120 dB Measurement resolution: 0.001 dB Display scale: 0.01 dB/div to 50 dB/div (1-2-5 sequence) Dynamic accuracy <table border="1"> <thead> <tr> <th>Level relative to IRG</th> <th>80 kHz to 100 MHz</th> <th>10 kHz to 300 MHz</th> </tr> </thead> <tbody> <tr> <td>0 to -10 dB</td> <td>± 0.30 dB</td> <td>± 0.30 dB</td> </tr> <tr> <td>-10 to -60 dB</td> <td>± 0.05 dB</td> <td>± 0.05 dB</td> </tr> <tr> <td>-60 to -70 dB</td> <td>± 0.10 dB</td> <td>± 0.30 dB</td> </tr> <tr> <td>-70 to -80 dB</td> <td>± 0.30 dB</td> <td>± 1.00 dB</td> </tr> <tr> <td>-80 to -90 dB</td> <td>± 1.20 dB</td> <td>± 4.00 dB</td> </tr> <tr> <td>-90 to -100 dB</td> <td>± 4.00 dB</td> <td>-</td> </tr> </tbody> </table>	Level relative to IRG	80 kHz to 100 MHz	10 kHz to 300 MHz	0 to -10 dB	± 0.30 dB	± 0.30 dB	-10 to -60 dB	± 0.05 dB	± 0.05 dB	-60 to -70 dB	± 0.10 dB	± 0.30 dB	-70 to -80 dB	± 0.30 dB	± 1.00 dB	-80 to -90 dB	± 1.20 dB	± 4.00 dB	-90 to -100 dB	± 4.00 dB	-
Level relative to IRG	80 kHz to 100 MHz	10 kHz to 300 MHz																				
0 to -10 dB	± 0.30 dB	± 0.30 dB																				
-10 to -60 dB	± 0.05 dB	± 0.05 dB																				
-60 to -70 dB	± 0.10 dB	± 0.30 dB																				
-70 to -80 dB	± 0.30 dB	± 1.00 dB																				
-80 to -90 dB	± 1.20 dB	± 4.00 dB																				
-90 to -100 dB	± 4.00 dB	-																				

Continued on next page

Phase measurement	Measurement range: $\pm 180^\circ$ Measurement resolution: 0.001° Display scale: 0.01° to 50° /div (1-2-5 sequence) Dynamic accuracy																					
	<table border="1"> <thead> <tr> <th>Level relative to IRG</th> <th>80 kHz to 100 MHz</th> <th>10 kHz to 300 MHz</th> </tr> </thead> <tbody> <tr> <td>0 to -10 dB</td> <td>$\pm 6.0^\circ$</td> <td>$\pm 6.0^\circ$</td> </tr> <tr> <td>-10 to -60 dB</td> <td>$\pm 0.3^\circ$</td> <td>$\pm 0.3^\circ$</td> </tr> <tr> <td>-60 to -70 dB</td> <td>$\pm 0.8^\circ$</td> <td>$\pm 2.0^\circ$</td> </tr> <tr> <td>-70 to -80 dB</td> <td>$\pm 2.0^\circ$</td> <td>$\pm 6.0^\circ$</td> </tr> <tr> <td>-80 to -90 dB</td> <td>$\pm 6.0^\circ$</td> <td>$\pm 20.0^\circ$</td> </tr> <tr> <td>-90 to -100 dB</td> <td>$\pm 20.0^\circ$</td> <td>-</td> </tr> </tbody> </table>	Level relative to IRG	80 kHz to 100 MHz	10 kHz to 300 MHz	0 to -10 dB	$\pm 6.0^\circ$	$\pm 6.0^\circ$	-10 to -60 dB	$\pm 0.3^\circ$	$\pm 0.3^\circ$	-60 to -70 dB	$\pm 0.8^\circ$	$\pm 2.0^\circ$	-70 to -80 dB	$\pm 2.0^\circ$	$\pm 6.0^\circ$	-80 to -90 dB	$\pm 6.0^\circ$	$\pm 20.0^\circ$	-90 to -100 dB	$\pm 20.0^\circ$	-
	Level relative to IRG	80 kHz to 100 MHz	10 kHz to 300 MHz																			
	0 to -10 dB	$\pm 6.0^\circ$	$\pm 6.0^\circ$																			
	-10 to -60 dB	$\pm 0.3^\circ$	$\pm 0.3^\circ$																			
	-60 to -70 dB	$\pm 0.8^\circ$	$\pm 2.0^\circ$																			
-70 to -80 dB	$\pm 2.0^\circ$	$\pm 6.0^\circ$																				
-80 to -90 dB	$\pm 6.0^\circ$	$\pm 20.0^\circ$																				
-90 to -100 dB	$\pm 20.0^\circ$	-																				
Group delay measurement	DRG: $\Delta\theta / (360 \times \Delta F) \times \Delta\theta$: phase measurement range; ΔF : frequency span x smoothing aperture (%); smoothing aperture: 20% to $\left(\frac{2}{\text{number measurement points}} \right) \times 100\%$ Measurement resolution: $2.78 \times 10^{-5} / \Delta F$ Display scale: 1 ps/div to 50 ms/div Dynamic accuracy: Phase measurement accuracy / (360 x aperture frequency)																					
Calibration, correction	Calibration types: Frequency response, 1 port, 1 path-2 port, frequency response/isolation calibration, π -NET calibration Calibration data interpolation: Measurement frequency, when number of measurement points changed, based on calibration data before change, new calibration data interpolation calculation possible (except at log frequency measurement and 1001 measurement points) Normalize: X-S Electrical length calibration Range: 0 to ± 999999.9999999 m, Resolution: 100 nm Phase offset range: $\pm 180^\circ$																					
Sweeping	Frequency sweep: LIN (CENTER/SPAN, START/STOP), LOG (START/STOP) Level sweep: LIN (START/STOP/STEP) List sweep: Frequency, level, RBW, the individual setting in the waiting time Number of measurement points: 11, 21, 51, 101, 251, 501, 1001 Break point: Anywhere between 1 and 1001 Sweep time: 150 μ s/point, 38 ms/250 points full sweep (RBW: 20 kHz, normalize calibration, 1 trace) Setting range: 1 ms to 27.5 h Sweep functions Sweep range: Full sweep, part sweep (between markers) Sweep control: REPEAT/SINGLE, STOP/CONT Sweep trigger: INT/EXT (RISE, FALL, LEVEL)																					
Display	Max. display screens: 2 channels, 4 traces Display format: LOG MAG (M), PHASE (P), DELAY (D), M/P, M/D, LIN MAG (LIN), LIN/P, LIN/D, REAL (R), IMAG (I), R/I, Z, Z/ θ , Q, Z/Q, POLAR, VSWR, IMPD (Z $\angle\theta$, Rs + Ls/Cs, Q/D, R + jx), ADMT (Y $\angle\theta$, Rp + Lp/Cp, Q/D, G + jB) Display: 640 x 480 dots, 16.5 cm color LCD																					
Markers	Marker functions: NORMAL MKR, Δ MKR, 0 MKR, MKR \rightarrow MAX, MKR \rightarrow MIN, MKR \rightarrow CF, Δ \rightarrow SPAN, MKR \rightarrow +PEAK, MKR \rightarrow -PEAK, MKR TRACK + PEAK, MKR TRACK-PEAK, MKR CHANGE, MKR OFFSET Setting: Set marker position to frequency or point Multi-marker: Max. 10 markers for each trace Filter function: F0, IL, passband (L, R), attenuation band (L, R), Ripple, Q, SF Resonator function RESON 1: Fr, Fa, Zr, Za (0 PHASE), Fm, Fn, Zm, Zn (MAX/MIN) RESON 2: Fs, Fr, Fa, Zr, Za, Q, equivalence constant (R1, L1, C1, C0)																					
Trace data calculation	Averaging functions Method: SUM, MAX, MIN, Count: 1 to 1000 Measurement data memory (max. 1001 points each memory in same format as display format) Main trace (MT) memory: 2 each (XMEM) for Channel 1 and Channel 2 Calibration S memory: 2 each (SMEM) for Channel 1 and Channel 2 Image memory: 2 each (IMEM) for Channel 1 and Channel 2 Sub-trace (ST): Following calculation between MT and ST (traces calculation of same data as display format) MT \rightarrow ST, MT = MT-ST, MT = ST Limit line: Single or segment (10) limit line, pass/fail evaluation against limit line																					
Measurement parameters auto-setting	Receive bandwidth and sweep time: Receive bandwidth set automatically for set sweep time Automatically set to give minimum sweep time at set receive bandwidth																					
Auxiliary media	Saving/recalling data: Measurement parameters, measured data, calibration data, PTA application programs saved/recalled to/from FD and PMC Function memory FD: 100 functions max. PMC: 100 functions max. (depends on PMC capacity) Drive and capacity 3.5 inch FDD: 1 Capacity: 720 KB (2DD), 1.44 MB (2HD), MS-DOS format (bmt, text file) Option 01: PMC (32 to 512 KB)																					
Printing	Printing is available using video plotter, printer and FD (bitmap format).																					

Continued on next page

Back-panel I/O	Frequency: 5/10 MHz \pm 10 ppm Level: \geq 0.7 V _{p-p} (AC coupling) Input impedance: 50 Ω (connector: BNC-J) Reference oscillator output Frequency: 10 MHz Level: TTL (DC coupling, connector: BNC-J) External trigger input: TTL Level (connector: BNC-J) GPIB: IEEE488.2 (24-pin Amphenol connector) I/O Port: Parallel interface for PTA (36-pin Amphenol connector) RGB output: For external monitor (15-pin D-SUB connector) Video output: Separate (8-pin DIN) Centronics (Option 02): Parallel interface for printer (25-pin D-SUB connector) RS-232C (Option 02): Serial interface (9-pin D-SUB connector)
External control	Standard: GPIB and PTA; Option 02: RS-232C
Power	100 to 120/200 to 240 Vac (–15%/+10%, 250 Vac max, 100/200 V system auto-switching), 47.5 to 63 Hz, \leq 180 VA (max.)
Dimensions and mass	426 (W) x 177 (H) x 451 (D) mm, \leq 15 kg
Environmental conditions	Temperature range: 0° to +50°C (operating; FDD: +4 to +50°C), –20° to +60°C (storage)
EMC	EN61326: 1997/A1, 1998 (Class A) EN61000-3-2: 1995/A2, 1998 (Class A) EN61326: 1997/A1, 1998 (Annex A)
LVD	EN610101-1: 1993/A2, 1995 (Installation Category II, Pollution degree 2)

Ordering information

Please specify model/order number, name, and quantity when ordering.

Model/Order No.	Name
MS4630B	Main frame Network Analyzer
	Standard accessories
	Power cord, 2.6 m: 1 pc
F0013	Fuse, 5 A: 2 pcs
W1534AE	MS4630B operation manual (main frame): 1 copy
W1535AE	MS4630B operation manual (remote control): 1 copy
	Options
MS4630B-01	PMC interface
MS4630B-02	RS-232C, Centronics interface (printer output, external control)
MS4630B-10	Output attenuator (70 dB, mechanical type)
MS4630B-12	3 channel receiver
MS4630B-13	High stability reference oscillator (aging rate: $\leq \pm 2 \times 10^{-8}$ /day)
MS4630B-14	3 branch output (for 3 channel receiver)
	Optional accessories
62BF50	Reflection Bridge
62B50	Reflection Bridge
62BF75	Reflection Bridge
62B75	Reflection Bridge
MA2201A	Reflection Bridge
MA2202A	Reflection Bridge
MA2203A	Reflection Bridge
MA2301A	Reflection Bridge
MA2302A	Reflection Bridge
MA2303A	Reflection Bridge
MA2204A	Impedance Probe
MA2403A	Impedance Probe
MA414A	Impedance Measurement Kit (for MA2403A)
MA1506A	π Network (DC to 125 MHz, for resonator measurement)
MA4605A	Impedance Adapter (for MS4630B, 10 Hz to 300 MHz, 50/75 Ω , unbalanced)
P0005	Memory card (32 KB)
P0006	Memory card (64 KB)
P0007	Memory card (128 KB)
P0008	Memory card (256 KB)
P0009	Memory card (512 KB)
MC3305A	PTA Key Board (JIS type)
MC3306A	PTA Key Board (ASCII type)
B0329C	Front cover (1MW4U)
B0333C	Rack mount kit
B0334C	Carrying case (hard type)
	Optional instruments
ME010 series	Test Fixture (PIN, SMD, tip-inductor, etc.)

SCALAR NETWORK ANALYZER 56100A 10 MHz to 110 GHz

For Scalar Analysis



GPIB

The 56100A Scalar Network Analyzer measures insertion loss, insertion gain, or RF power with 76 dB dynamic range. Measure device match as return loss in dB or as SWR. Separate detectors can be used on all four inputs for multiple transmission measurements on duplexers or matched amplifiers.

Transmission and reflection measurements can be viewed simultaneously. Both traces can be scaled independently in dB, dBm, or SWR. Measurement of the ratio of two detector inputs may be applied to either channel for enhancing accuracy or for viewing differences. Built-in calibration allows subtraction of the unwanted transmission frequency response or the average of open/short reflections from either trace. A Volt Mode is available for displaying voltage (with volt mode adapter cable). A 0 to 10 volt sweep ramp output mode is also available.

Features

- Compatible with Anritsu 68/B/C and 69A/B sweep generators
- 10 MHz to 110 GHz
- Four input channels
- Extensive cursor, markers, and limit lines
- Applications functions for improved productivity

REFLECTION BRIDGES

When connected to a reflection bridge, the network analyzers can measure reflection coefficient. This system is used to measure the input and output impedance of telecommunication, video, and audio equipment, and the S-parameter (S_{11} and S_{22}) of two-port networks.



MA2401A



MA2201A

TRANSFORMERS

The transformers are impedance-conversion devices used with the network analyzers to measure the magnitude, phase, delay, level, and spectrum of devices with balanced input and output impedances.

Features

- Input connector is a BNC-type in an unbalanced circuit
- Output connector is a terminal compatible with M-214
- Frequency response: <math><0.3\text{ dB}</math>
- Return loss: >25 dB

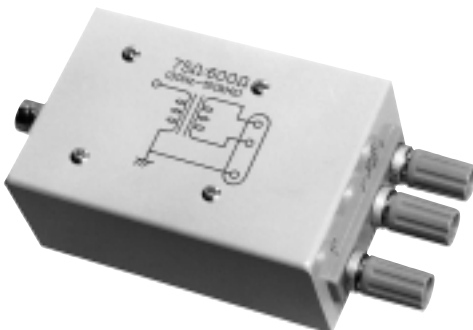

Model	Impedance (Ω)		Frequency range
	Input	Output	
MA29A	75	600	30 Hz to 150 kHz
MA29J	50	600	30 Hz to 150 kHz
MA313A	75	75	4 kHz to 2 MHz
MA313J	50	75	4 kHz to 2 MHz
MA314A	75	135	4 kHz to 2 MHz
MA314J	50	135	4 kHz to 2 MHz
MA315A	75	150	4 kHz to 2 MHz
MA315J	50	150	4 kHz to 2 MHz
MA422A1	75	110	10 Hz to 30 kHz



ELECTRONIC COUNTERS, POWER METERS, VOLTMETER

Microwave Frequency Counter	388
Power Meters	391
Voltmeter	398

MICROWAVE FREQUENCY COUNTER

MF2400B Series

10 Hz to 20/27/40 GHz

For Measuring CW Frequency and Pulse Width of Burst Signals



CE GPIB

The MF2400B series consists of three frequency counters: the MF2412B (20 GHz), the MF2413B (27 GHz), and the MF2414B (40 GHz). They are ideal for evaluating mobile radio communications devices and circuits, with the ability to measure the carrier frequency and pulse width of burst signals. In addition to displaying measurement results on a 12-digit LCD, the frequency values can be read using the analog display function, which is ideal for monitoring evaluation and especially for frequency adjustment, etc., as in the case of various types of oscillators.

Furthermore, the template function is useful for assessing quickly whether or not the measurement results fall within the upper and lower frequency limit specifications; the evaluation result is output from the AUX connector on the rear panel as a Go/No-go signal. An easy-to-use automatic measurement system can be configured using the GPIB function.

Features

- Measures carrier frequency and pulse width of burst signals
- Analog frequency display
- Pass/Fail evaluation for frequency range specified by template function
- Measurement of any burst section using gating function

Functions

• Wide band measurement

The three counters, with upper frequency limits of 20, 27 and 40 GHz, meet every usage requirement. In addition, a high-frequency fuse holder and fuse element protects the input circuit from excessively powerful signals, and a variety of adapters are available for coupling each connector.

• High-accuracy burst measurement

The carrier frequency, burst width, and burst repetition rate of a 100 ns to 0.1 s burst signal input from INPUT 1 can be measured quickly with high accuracy.

• Save and recall functions added

Up to a maximum of 10 setups can be stored in the internal memory, and these can be freely recalled. Storing complex setups in advance, such as burst triggers and gate settings, makes it possible to recall them immediately when needed for measurement, which makes it possible to reduce the measurement setup time and to prevent malfunctions from setup mistakes.

• Analog display function

Using this function, the entire LCD becomes an analog meter and the measured values are indicated by the position of the meter needle. In addition to measuring changes in the frequency, this permits faster frequency adjustment and Go/No-go judgement of oscillators, which had to be read many digits of measured data before. This analog meter also solves problems associated with misreading frequency values.



Moves left/right and indicates frequency value

• Template function

After the upper and lower frequency limits have been preset, if the measured frequency is within the preset range, Go is displayed; if it is out of range, No-go is displayed. In addition, the Go/No-go signal can be output from the AUX connector on the back panel as a TTL signal. This is very useful for configuring an automatic device Pass/Fail evaluation system (using analog display).

• High-speed transient measurement

Frequency counters have an interval when measurement is not performed (sample rate), so that sudden frequency changes during this period cannot be measured. However, the MF2400B series overcomes this problem by capturing frequency changes at speeds of up to 10 μ s and saving a maximum of 2000 sampling points. When it is combined with a host computer, frequency changes can be displayed graphically. This is very effective for measuring VCO start-up characteristics and PLL lock times.

• Gating function

With burst signal measurements, the carrier frequency may be different at the start, middle, and end of the burst. In the MF2400B series, the carrier signal frequency at any position of the signal (delay time from trigger signal leading edge) and at any specified time (gate time) can be measured using a combination of the gating and trigger delay functions.

Specifications

• MF2400B series

Input	Frequency range	INPUT 1 MF2412B: 600 MHz to 20 GHz, MF2413B: 600 MHz to 27 GHz, MF2414B: 600 MHz to 40 GHz INPUT 2 10 MHz to 1 GHz (50 Ω), 10 Hz to 10 MHz (1 MΩ)																
	Input level range (sine wave input)	INPUT 1 -33 to +10 dBm (<12.4 GHz), -28 to +10 dBm (<20 GHz), -25 to +10 dBm (<27 GHz), [-44.6 + 0.741 x frequency (GHz)] to +10 dBm (≤40 GHz) INPUT 2 25 mVrms to 2 Vrms (50 Ω), 25 mVrms to 10 Vrms (1 MΩ)																
	Impedance, coupling	INPUT 1: 50 Ω, AC couple INPUT 2: 50 Ω or ≥1 MΩ (≤35 pF), AC couple																
	Connector	INPUT 1 MF2412B: N-type, MF2413B: SMA-type, MF2414B: K-type INPUT 2: BNC-type																
Gating function	Trigger mode	INT: Triggered by measurement signal EXT: Triggered by external signal *Trigger level: 1.5 V ± (2 to 10 Vp-p), Trigger pulse width: ≥1 μs, Impedance: ≥100 Ω, Coupling: DC LINE: Triggered by AC line signal																
	Trigger delay	20 ns to 0.1 s ^{*1} , off (≤320 ns in 20 ns steps, and <1 μs in 40 ns steps variable; ≥1 μs in continuously variable as effective two digits)																
	Gate width	100 ns to 0.1 s (<1 μs in 20 ns steps variable; ≥1 μs in continuously variable as effective two digits)																
Pulse modulation wave measurement	Frequency range	MF2412B: 600 MHz to 20 GHz, MF2413B: 600 MHz to 27 GHz, MF2414B: 600 MHz to 40 GHz																
	Pulse width	100 ns to 0.1 s (NARROW), 1 μs to 0.1 s (WIDE)																
	Pulse repetition frequency	10 Hz to 4 MHz (pulse off time: ≥240 ns)																
	Carrier frequency measurement ^{*2}	Max. resolution: 10 kHz (pulse width: 100 ns to 1 μs), 1 kHz (pulse width: 1 to 10 μs), 100 Hz (pulse width: 10 to 100 μs), 10 Hz (pulse width: 0.1 to 1 ms), 1 Hz (pulse width: 1 to 10 ms), 0.1 Hz (pulse width: 10 to 100 ms) Measurement time: (T or T _s whichever is greater) x {1/(f _R x TGW)} ^{*3} <table border="1" style="margin-left: 20px;"> <tr> <td>Resolution</td> <td>1 Hz</td> <td>10 Hz</td> <td>100 Hz</td> <td>1 kHz</td> <td>10 kHz</td> <td>100 kHz</td> <td>1 MHz</td> </tr> <tr> <td>Measurement time</td> <td>200 s</td> <td>20 s</td> <td>2 s</td> <td>200 ms</td> <td>20 ms</td> <td>5 ms</td> <td>5 ms</td> </tr> </table> *Measurement carrier frequency: 1 GHz (TGW ^{*3} = 0.1/f _R) Accuracy: ±1 count ±time base accuracy x measurement frequency ±trigger accuracy ±residual error ^{*5} ±1/TGW ^{*3}	Resolution	1 Hz	10 Hz	100 Hz	1 kHz	10 kHz	100 kHz	1 MHz	Measurement time	200 s	20 s	2 s	200 ms	20 ms	5 ms	5 ms
	Resolution	1 Hz	10 Hz	100 Hz	1 kHz	10 kHz	100 kHz	1 MHz										
	Measurement time	200 s	20 s	2 s	200 ms	20 ms	5 ms	5 ms										
Pulse width measurement	Resolution: 1 ns Accuracy: ±20 ns ±time base accuracy x measurement pulse width ±trigger accuracy Unit indication: μs (fixed)																	
Pulse period measurement	Resolution: 1 ns Accuracy: ±20 ns ±time base accuracy x measurement period ±trigger accuracy Unit indication: μs (fixed)																	
Carrier wave frequency measurement	Resolution, gate time	INPUT 1 NORMAL: 1 MHz/1 μs to 0.1 Hz/10 s FAST: 1 MHz/0.18 μs to 0.1 Hz/1.8 s (typical) INPUT 2 10 MHz to 1 GHz (50 Ω): 1 MHz/1 μs to 0.1 Hz/10 s 10 Hz to 10 MHz (1 MΩ): Shown below 																
	Measurement accuracy	INPUT 1 NORMAL: ±1 count ±time base accuracy x measurement frequency ±residual error ^{*4} FAST: ±1 count ±time base accuracy x measurement frequency ±trigger accuracy ±residual error ^{*5} INPUT 2 10 MHz to 1 GHz: ±1 count ±time base accuracy x measurement frequency 10 Hz to 10 MHz: ±1 count ±time base accuracy x measurement frequency ±trigger accuracy																
Auto/manual measurement	Auto FM tolerance: 35 MHzp-p, Acquisition time: ≤50 ms Manual (CW measurement) Input allowable frequency range: ±30 MHz (600 MHz to 1 GHz), ±40 MHz (≥1 GHz) Acquisition time: ≤15 ms Manual (Burst measurement) Input allowable frequency range: ±30 MHz (600 MHz to 1 GHz, pulse width mode: WIDE), ±20 MHz (≥1 GHz, pulse width mode: NARROW), ±40 MHz (≥1 GHz, pulse width mode: WIDE) Acquisition time: ≤15 ms																	

Continued on next page

Functions	Template: Inputs in upper/lower limit of frequency, judged on GO/NO-GO Frequency offset: +offset, -offset, ppm Statistical processing: mean, maximum, minimum, p-p Save/recall: 10 panel settings (Max.)
AUX output	Output for GO/NO-GO, count end, input level detection, internal gating, restart, and acquisition signal
Sample rate	1 ms to 10 s (1-2-5 steps), hold
High-speed sample period/frequency resolution	INPUT 1: 10 μ s/10 kHz, 100 μ s/1 kHz, 1 ms/100 Hz INPUT 2: 10 μ s/100 kHz, 100 μ s/10 kHz, 1 ms/1 kHz *Measurement frequency: 100 MHz
Memory back up	Store in non-volatile memory at instrument power-down
Display	Display digits: 12 digits and 1 digit (- mark) LCD: 248 x 60 dots (with back light)
Reference crystal oscillator	Frequency: 10 MHz Warm-up: $\leq \pm 5 \times 10^{-9}$ /day (after 30 min. warm-up) Aging rate: $\leq \pm 2 \times 10^{-8}$ /day (after 24 h warm-up) Temperature characteristics: $\pm 5 \times 10^{-8}$ (0° to 50 °C)
External reference input	1/2/5/10 MHz, Input voltage: 1 to 5 Vp-p (AC coupling), Input impedance: ≥ 1 k Ω
External reference output	1/2/5/10 MHz ^{*6} , Output voltage: ≥ 2 Vp-p (open end, AC coupling), Output impedance: ≤ 400 Ω
External control	GPIB (conforms to IEEE488.2 standards): SH1, AH1, T5, L4, SR1, RL1, PP0, DC1, DT1, C0, E2
Power	85 to 132/170 to 250 V (auto switch), 47.5 to 63 Hz, ≤ 80 VA
Operating temperature	0° to 50 °C
Dimensions and mass	213 (W) x 88 (H) x 350 (D) mm, ≤ 5 kg
EMC	EN61326: 1997/A1, 1998 (Class A) EN61000-3-2: 1995/A2, 1998 (Class A) EN61326: 1997/A1, 1998 (Annex A)
LVD	EN610101-1: 1993/A2, 1995 (Installation Category II, Pollution degree 2)

*1: Delay time until counter started by trigger detection

*2: MANUAL measurement mode

*3: f_R : frequency resolution, TGW: gate width, T_s: processing time (50 μ s), T: period (2/ f_R)

*4: Measurement frequency (GHz)/10 count (rms)

*5: Measurement frequency (GHz)/2 count (rms)

*6: 10 MHz when using internal reference signal; outputs signal based on this signal (1/2/5/10 MHz) when using external reference signal

• Options 01/02/03: Crystal oscillator

Option number	01	02	03
Frequency	10 MHz		
Aging rate	5 x 10 ⁻⁹ /day, 5 x 10 ⁻⁹ /month, 7.5 x 10 ⁻⁹ /year *After power on, with reference to frequency after 24 h	2 x 10 ⁻⁹ /day, 3 x 10 ⁻⁹ /month, 4.5 x 10 ⁻⁹ /year *After power on, with reference to frequency after 24 h	5 x 10 ⁻¹⁰ /day, 1 x 10 ⁻⁹ /month, 1.5 x 10 ⁻⁹ /year *After power on, with reference to frequency after 48 h
Temperature characteristics	$\pm 5 \times 10^{-8}$ -10° to 60°C (with reference to 25°C)	$\pm 1.5 \times 10^{-8}$	$\pm 5 \times 10^{-9}$

Ordering information

Please specify model/order number, name, and quantity when ordering.

Model/order No.	Name
MF2412B MF2413B MF2414B	Main frame Microwave Frequency Counter
F0012 W1520AE	Standard accessories Power cord, 2.5 m: 1 pc Fuse, 3.15 A: 2 pcs MF2412B/2413B/2414B operation manual: 1 copy
MF2412B-01 MF2413B-01 MF2414B-01 MF2412B-02 MF2413B-02 MF2414B-02 MF2412B-03 MF2413B-03 MF2414B-03	Options Crystal oscillator (5 x 10 ⁻⁹ /day) Crystal oscillator (5 x 10 ⁻⁹ /day) Crystal oscillator (5 x 10 ⁻⁹ /day) Crystal oscillator (2 x 10 ⁻⁹ /day) Crystal oscillator (2 x 10 ⁻⁹ /day) Crystal oscillator (2 x 10 ⁻⁹ /day) Crystal oscillator (5 x 10 ⁻¹⁰ /day) Crystal oscillator (5 x 10 ⁻¹⁰ /day) Crystal oscillator (5 x 10 ⁻¹⁰ /day)

Model/order No.	Name
K224*1	Optional accessories Coaxial adapter (K-P · K-J, SMA compatible, DC to 40 GHz, SWR: 1.2)
34RKNF50	Coaxial adapter (ruggedized K-P · N-J, DC to 20 GHz, SWR: 1.25)
J0060 J0526 J0527 J0127A J0853 J0854 MP612A*2 MP613A*2	Coaxial adapter (N-J · SMA-P) Coaxial adapter (N-J · SMA-J) Coaxial cord (K-P · K-P), 2 ft Coaxial cord (BNC-P · RG-58A/U · BNC-P), 1 m Coaxial cord (N-P · SF104P · N-P), 2 m Coaxial cord (APC3.5-P · SF104P · APC3.5-P), 2 m Fuse Holder (N-P · N-J, DC to 1 GHz) Fuse Element (DC to 1 GHz, Power rating: +17 dBm, Blow rating: $\geq +35$ dBm)
J0007 J0008 B0426A B0409 B0329L B0390G B0411A ERV713-H J0997	GPIB cable, 1 m GPIB cable, 2 m Carrying bag (soft type) Carrying case (with B0329L protection cover) Protection cover Rack mount kit (19 inch type, one unit) Rack mount kit (19 inch type, two units, side by side) Portable power supply (Matsushita product) Adapter (for portable power supply)

*1: The K224 adapter is used to prevent damage to the input connector.

*2: The MF2400B series has the MP612A Fuse Holder (with MP613A Fuse Element) to prevent input of excessive power. In addition, the MP612A Fuse Holder has an N-type connector, so an adapter is required according to the coupled connector type.

POWER METERS

ML2400A/2430A Series

For Measuring Wide Dynamic Range Power



The ML2430A series Power Meters combine the advantages of thermal meter accuracy, diode meter speed, and peak power meter display graphics. The result is a single instrument that achieves 90 dB dynamic range with a single sensor. The ML2430A series includes graphics display capability as a standard feature. The ruggedized housing and optional high-capacity NiMH battery bring convenience and accuracy to field service applications.

Performance

• Speed and dynamic range

The 90 dB range MA2470A series Power Sensors' high sensitivity reaches stable power readings to -70 dBm. 35 kHz sample rates profile cellular, PCS, and other pulsed signals to 0.1 μ sec resolution. Modern connector technology achieves industry-leading return loss for improved accuracy through 50 GHz. The 87 dB range MA2440A series High Accuracy Sensors further improve return loss performance by adding a matching circuit to the MA2470A series' front end.



New power sensor technology achieves industry leading measurement linearity and high sensitivity.

• Universal power sensors

The new MA2480A series Universal Power Sensor will measure any modulated or multi-tone signal thanks to a patented sensor architecture with three diode pairs. Universal power sensors deliver over 80 dB of dynamic range with speed and accuracy.

Average power measurements on WCDMA signals can now be made without the need for special power meters. Universal sensors are also ideal for power measurements on other digitally modulated carriers such as HDTV, DAB or QAM modulated radio links.

The sensor architecture ensures that one of the diode pairs is always operating in its square law region. The meter selects the diode pair operating in its square law region and is designed so that even the peaks of CDMA signals are measured accurately. Anritsu's three stage diode pair approach leads to a very much faster measurement time than the two stage approach used in previous generations of average power sensors. No slowing of measurement speed is observed at switching points, making them transparent to the user.

Universal power sensors are also ideal for applications where multiple signals are present, such as intermodulation measurements and satellite multi carrier power loading measurements.

A unique additional capability of the Anritsu Universal power sensor is the ability to use it as a standard diode sensor for fast CW measurements and pulse or TDMA measurements. In this mode the fast response of diode sensors is maintained across the full dynamic range of the sensor, meaning that for the majority of users it is the only sensor that they will ever need - a truly Universal Power Sensor.

• Fast thermal sensors

Anritsu's latest semiconductor processing technology produces thermal power sensors with speed increased by an order of magnitude. Improvements in connector technology reduce measurement mismatch uncertainty through 50 GHz to levels previously attained only to 20 GHz. The fabrication technique, as well as the ML2430A's sampling and DSP technology, optimize measuring speed to 4 ms rise and fall times.

• GPIB speed

Industry leading speed of >600 continuous readings per second is achieved under a variety of operating conditions including averaging settings, sensor control settings, triggering conditions, operating mode, sensor type, and GPIB interface manufacturer. The ML2430A series offers the ability to measure and transfer a high-speed burst of 200 data points using profile operating mode with sampling rates of 35k per second.

• GPIB emulation

With 99.9% emulation of older meters, the ML2430A series improves ATE system productivity. Typical test system speed improvement is 2 to 10 times faster system speed depending upon the number of measurements taken during the test, the minimal use of wait statements within the code, and the meter model emulated.

• Triggering controls

What use is high speed without triggering and sample controls? Data acquisition event arming and triggering functions traditionally found on expensive peak power meters are standard in the ML2430A series. Triggering delay and the sample integration time per reading can be directly controlled by the operator. Trigger sources include, continuous, internal, external TTL, and manual. Thus, data acquisition can be optimally controlled for synchronization with other test equipment.

• Burst profile graphics display

The ML2430A features random repetitive sampling for high resolution of fast signals. A time domain graphic display profiles pulsed signals over a power range of -40 dBm to +20 dBm. 35 kHz sampling speed produces clear power profiles of cellular and PCS signals including TDMA, PHS, GSM, and DCS-1800. Pulse top power is easily and repeatably measured using between cursor averaging. Measure pulse-top power over >80 dB dynamic range in readout mode at GPIB speeds >200 readings per second.

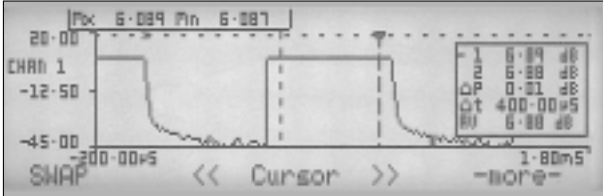

• Power vs. time graphics display

The power versus time mode is a strip chart style display for monitoring gain and output power variations over time/temperature, supply voltage, or a component tolerance. In service applications, measurement of power versus time aids trouble shooting of unusual conditions, such as intermittent switches or abnormal power control in a mobile telephone base stations. The power versus time mode provides a clear strip chart display of RF power variation.

• Source sweep graphic display

Power Sweep or frequency sweep data are acquired at more than 10 sweeps per second over GPIB. Synchronization with synthesizers requires connection (BNC) of a 0.0 V sweep ramp input and an RF blanking/dwell input.

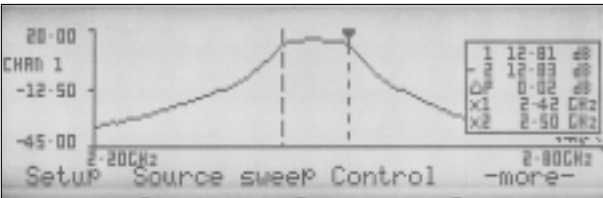

• Parallel printer connector

Many deskjet series printers can be connected directly to the ML2430A for fast documentation of performance on the bench or in the field. Meter calibration, triggering, and averaging settings are listed with the display printout. Thus, evidence of DUT (device under test) anomalies can be duplicated quickly.

• 90 dB dynamic range

Typical communications industry ATE systems operate over a 60 to 80 dB dynamic range. The MA2470A series' 90 dB dynamic range replaces two 50 dB sensors. Furthermore, an RF switch is no longer needed for the two sensors. This reduces software control complexity and further speeds test execution.

• Sensor EEPROM

All MA2400A series sensors are equipped with internal EEPROMs for storage of calibration factor data vs. frequency. This allows the power meter to interpolate and correct readings automatically, improving accuracy and convenience.

• High reliability

A rugged polycarbonate chassis handles drop shocks and rough field treatment. The absence of vent holes makes the meter splash resistant. A front cover panel and softcase are optional for further environmental protection. Power sensors are also ruggedized for rough handling.

• Improved accuracy

Mismatch uncertainty is typically the largest source of error. The MA2400A series Power Sensors offer a typical 5 to 6 dB improvement in sensor return loss, typically cutting mismatch uncertainty in half. The MA2440A series High Accuracy Sensors incorporate a matching pad which further improves return loss by 5 to 6 dB — again halving mismatch uncertainty.

• Offset table for path loss correction

Compensating for the true frequency response of attenuators, couplers, cables, switches, and other test setup devices improves measurement accuracy. For this reason, the ML2430A series can apply an offset table of attenuation-versus-frequency in addition to the traditional fixed dB offset capability. When a power sensor connection is preceded with a new 1N series wideband power limiter, the offset table compensates for frequency response. Thus, the combination achieves an accurate, "burnout-proof" sensor.

• Softkey menu control

Softkey menus simplify instrument control by making the user interface easier to understand. The numerical keypad simplifies the operator interface.

• Battery

The optional NiMH "Smart" battery supports high charge density for a typical 8 hour day of operation. Accurate fuel gauging, <2 hour fast charge cycling, and the elimination of NiCd style memory effect further enhance the convenience of this battery technology.

• Voltmeter

The optional ML2430A series also supports high-speed voltage measurement. A rear panel BNC measures voltage or operates as V/GHz input supporting automated sensor calibration factor correction.

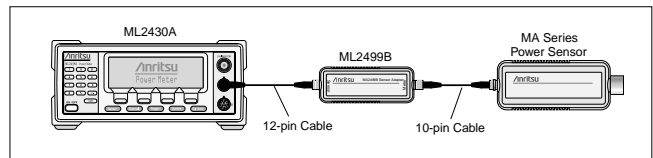

• Sensor Adapter, MA2499B

The ML2499B Sensor Adapter operates with older (10-pin) MA Series Power Sensors. An internal EEPROM allows storage of up to 9 sets of sensor calibration factor tables. Each table is individually selectable from the sensor menu. MP series waveguide power sensors are also compatible when used with the MA4002A adapter.

• High power applications

Traditional high power sensors are expensive and have degraded accuracy specifications. Further, their annual calibration requires more time and expense. Anritsu's new User Calibration Factor Tables avoid these problems. Any attenuator or coupler can be compensated by entering frequency and attenuation values into the MA2400A Series Power Sensors internal EEPROM. The attenuation device can be semi-permanently attached; the power meter automatically applies compensation during the 0.0 dBm, 50 MHz calibration reference process. The User Calibration Factor Tables are easily deactivated — allowing the power sensor to be used stand-alone also.

• Remote monitoring by telephone

Monitor transmitter performance remotely with standard telephone lines using the ML2430A's full duplex RS-232 and dial-out capabilities. When the ML2430A detects a high or low limit line violation, it will automatically dial a phone number. The meter's data acquisition settings can adjust to monitor average power or the burst power of specific timeslots. The RS-232 port uses the same commands as the GPIB. Contact your Anritsu representative for PC compatible software.

• Locate power sensors remotely

Some power meter applications require the sensor and meter to be separated by long distances or physical barriers. There is no requirement to perform a 0.0 dBm reference with the power meter; however, the lack of a reference may cause a small offset error. When a reference is desired, the MA2418A Reference Oscillator (0.0 dBm, 50 MHz) provides a convenient solution. DC power supply, and small size allows the MA2418A to be embedded in switch matrices or other enclosures. When a power sensor's cable must pass through walls or shielded enclosures, the ML2400A/29 Bulkhead Adapter provides a convenient connection between two sensor cables.

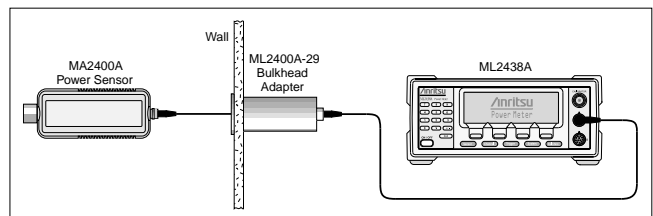



• N-CDMA Power Measurements

The Anritsu ML2407A power meter and MA2460A/B series power sensor have been specifically designed to make the exacting measurements required on N-CDMA signals. Today's digital radio standards employ a variety of techniques to enhance performance and increase spectral efficiency. Application of Code Division Multiple Access (CDMA) technology enables multiple users to share the same spectrum, with a channel bandwidth of 1.2288 MHz. Having a much wider channel bandwidth than earlier generation analog or TDMA systems has created new challenges for radio and component equipment manufacturers.

The Anritsu MA2460A/B series power sensor has a video bandwidth of 1.25 MHz. When used with the ML2407A (single channel) or ML2408A (dual channel) power meters, it is able to correctly characterize IS-95 waveforms and accurately measure average power. Advanced signal processing with fast sampling speeds facilitate measurements of peak power and crest factor.

The dual diode MA2460A/B series power sensor is both fast and accurate. It delivers over 80 dBs of dynamic range, making it suitable for both open and closed loop power control testing. A built-in EEPROM automates sensor calibration factor correction to simplify test set up and reduce human error.

EEPROM correction also corrects for sensor linearity across a range of temperatures, providing test engineers with unmatched measurement accuracy under all operating conditions.

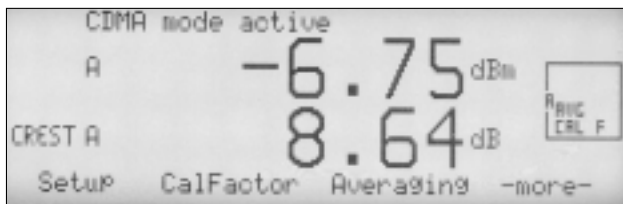

• Power Meter ML2407A

For automated measurements under GPIB control, the ML2407A power meter offers many class-leading features. Over 600 readings per second are available in fast mode, reducing total test time. Programmers have control over low-level averaging, sensor setting, and noise reduction for optimization of program speed. The sensors internal AC detection circuitry delivers a guaranteed noise floor of -60 dBm with typical performance to -70 dBm, even when measuring CDMA signals.

When testing transmitters and amplifiers it is often necessary to measure crest factor. If an amplifier is unable to cope with the peaks within the signal they will be attenuated and information lost.

Amplifiers are often tested across a range of average powers to ensure that the crest factor is maintained. This provides a simple way of ensuring that the amplifier is maintaining linearity across its full dynamic range. The Anritsu ML2407A facilitates tuning of amplifiers through the use of a crest factor time window. The period of time for which a peak will be stored is set by the user. Thus the change in crest factor can be monitored as the average power into an amplifier is increased.

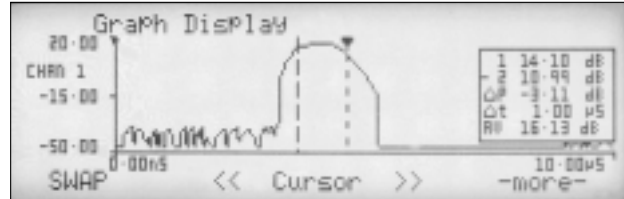

• Fast Pulse Analysis

The MA2460A/B series sensor also benefits from improved pulse response times. Pulses down to 1 µs can now be captured and displayed thanks to a sensor rise time of 0.6 µs. It is becoming increasingly common for amplifiers to be tested by analyzing their responses to short pulses. The ML2407A in profile mode can graphically display the pulse shape. Two cursors can be positioned on the trace and cursor readouts show the power at each cursor position plus the average power between the cursors.

Triggering for pulse analysis is from a TTL input or from a rising or falling edge. Variable trigger delay provides the ability to view the whole pulse profile or exactly the portion of the pulse of interest. With the ML2408A dual channel power meter, the pulsed gain of an amplifier can be measured directly.

• PowerSuite

PowerSuite software runs on a standard PC running Windows® 95 (or higher). PowerSuite adds the following measurements to the capability of the Anritsu ML2400A series power meters:

- Statistical power analysis
 - Probability Density Function (PDF)
 - Cumulative Density Function (CDF)
 - Inverse Cumulative Function (1-CDF)
- Pulse characterization (pulse width, rise time, peak power, pulse power, overshoot repetition, and period)
- GSM (and other TDMA) time slot power analysis
- Automated amplifier compression analysis
 - Single frequency compression
 - Compression vs frequency

Statistical analysis of power distribution can reveal important information to optimize CDMA system design. PDF displays the percentage of time (or samples) that the power is at a specific value. CDF takes the same data but displays the percentage of time (or samples) that the power is at or below a specific value. Analyzing this data can reveal how a system or device may be distorting the signal that it is transmitting. Comparison of the CDF plots from an amplifier at differing average power levels validates linearity and reveals the potential introduction of data errors.

PowerSuite is a very flexible package that provides full user control over measurement settings. The screen can be set for continuous update so that changes to the device or system under test can be viewed instantly. Alternatively plots can be archived for later analysis.

Specifications ML2400A and ML2430A Series

Frequency range	100 kHz to 90 GHz (sensor dependant)	
Power sensors	Meter specifications apply to MA2400A/B series Power Sensors. Compatible with MA and MP series sensors.	
Sensor dynamic range	MA2420A/B Series Thermal Sensors: 50 dB MA2440A Series High Accuracy Power Sensors: 87 dB CW, >57 dB Peak MA2460A/B Series Fast Diode Sensors: 80 dB MA2470A Series Power Sensors: 90 dB CW, >60 dB Peak MA2480A Series Universal Sensors: 80 dB	
Power measurement range	-70 to +47 dBm (0.1 nW to 50 W), sensor/attenuator dependent. Use couplers for higher power levels.	
Voltage measurement range	0.00 to 20.00 V, nominal	
Display range	-99.999 to +99.999 dB	
Display resolution	Selectable from 0.1 dB to 0.001 dB limited to 0.01 dB in graphical display modes; Linear power units, 3 to 6 digit, 1 - 3 digits selectable to right of decimal nW - W; Voltage, 1 - 2 digits selectable to right of decimal.	
Offset range	-99.999 to +99.999 dB. Fixed value or frequency dependent table.	
Display units	dBm, dB, dBr, dBmV, dBuV, W, %, Volts	
Instrumentation accuracy	<0.5%	
Zero set and drift	ML2437/8A <0.5% of full scale in most sensitive range, measured over one hour with maximum averaging after one hour warm up at constant temperature. ML2407/8A <1.8% of full scale in most sensitive range, measured over one hour with maximum averaging after one hour warm up at constant temperature.	
Noise	ML2437/8A <0.5% of full scale in most sensitive range, ML2407/8A <1.8% of full scale in most sensitive range, both measured over a one minute interval with maximum averaging, two standard deviations at constant temperature after hour warm up, typical. MA 2470 series, 20 pW typical.	
1.00 mW power reference	Frequency: 50 MHz nominal Output level: 1.00 mW, $\pm 1.2\%$ /year, $\pm 0.9\%$ RSS, NIST Traceable Maximum input: +20 dBm continuous or peak, ± 50 V dc VSWR: <1.04 Connector: Type N female	
Sensor/channel control	Operating modes	Readout, dual channel. RF power or voltage. Power versus time: Single channel graphic of readout data Profile: Single channel RF peak power graphic display for analysis of repetitive pulse or transient waveforms Source sweep: Single channel power sweep or frequency sweep NCDMA Average Power, Peak Power and Crest Factor - ML2407/8A only.
	Range hold	Current range or selectable 1 through 5.
	Averaging	Auto-averaging: Automatically increases moving averaging at low power ranges. Averaging types: Auto, Manual (Moving, Repeat) Manual average range: 1 to 512 Low-level averaging: Low, Medium, and High settings apply post average low pass filter to improve visibility at high display resolution.
	Limit lines	Fixed value high and low limits with audible, rear panel TTL output, and/or visible Pass/Fail alarm indication. Failure indication can latch for transient failure detection.
	Cursors	Two manually adjustable cursors with power, delta cursor power, between cursor power average, and delta time readout display.
	Delta t resolution	0.5% of display period or 100 ns
Triggering	Trigger sources	Internal, External TTL, GPIB, Manual, Continuous
	Delay range	0.0 to 999.0 Milliseconds
	Delay resolution	0.5% of display period or 100 ns
	Internal trigger range	-15 to +20 dBm, all diode sensors. Selectable to -25 dBm.
	Internal trigger level accuracy	1.0 dB, typical
	External trigger range	TTL rising or falling edge trigger. BNC input
Manual trigger	Front panel softkey	
Channel bandwidth	ML2437/38A 100 kHz nominal ML2407/08A 1.4 MHz nominal	

Continued on next page

System configuration	Display	LCD graphic display with backlight and adjustable contrast.	
	Save/Recall	10 storage registers plus RESET default settings	
	Secure mode	Erases memory information upon power ON. Default condition is secure mode OFF.	
	Rear panel inputs/ outputs	Cal factor voltage input (BNC)	Operating modes Voltage: Display voltage reading on selected channel Voltage proportional to frequency for sensor calibration factor compensation Blanking input: TTL levels only. Selectable positive or negative polarity. Input range: 0 to 20 V Resolution: 0.5 mV Control: Adjustable voltage to frequency relationship
		Analog output (BNC): two outputs configurable to log or lin	Operating modes: Analog out: Selectable channel adjusted for calibration factors and other power reading correction settings. Pass/Fail: Selectable TTL High or Low Channel output: Near real time analog. Uncalibrated. AC modulation output: Output 1 only. Dwell output: Output 2 only Output range: -5.0 to 5.0 V Resolution: 0.1 mV
		Trigger input	Operating modes: External TTL or RF Blanking.
		GPIB interface	IEEE-488.2 and IEC-625
RS-232		Supports software download and modem dial-out.	
Parallel printer output	Compatible with Deskjet 540 and 310 models. Other 500 series and 300 series and later are typically compatible. Also Canon BJC 80. See manual for DIP switch settings.		
General specifications	General	MIL-T28800E, Type 3, class 5, Style E	
	Display	Flat panel monochrome LCD graphic with backlight	
	Operating temperature range	0.0 to +50°C.	
	Storage temperature range	-40 to +70°C	
	Moisture	Splash and rain resistant, 95% humidity non-condensing.	
	Power requirements	AC: 90 to 250 Vac, 47 to 440 Hz, 40 VA maximum DC: 12 to 24 Vdc, Reverse protected to -40. Maximum input 30 V. Battery: >6 hr usable with 3000 mAh battery	
	Replaceable battery (Option)	3000 mAh NiMH	
	EMI	Complies with requirements for CE marking.	
	Warranty	1 to 2 year additional available	
	Dimensions	8.39 inches (213 mm) wide, 3.46 inches (88 mm) high, 9.84 inches (390 mm) deep	
	Weight	<6.6 lbs (<3 kg)	

Power sensor specifications

Model	Frequency range	Dynamic range (dBm)	SWR	Rise time* ¹ (ms)	Sensor linearity	RF connector* ²
Standard diode sensors						
MA2472A	10 MHz - 18 GHz	-70 to +20	<1.90; 10 - 50 MHz <1.17; 50 - 150 MHz <1.12; 0.15 - 2 GHz <1.22; 2 - 12.4 GHz <1.25; 12.4 - 18 GHz <1.35; 18 - 32 GHz <1.50; 32 - 40 GHz <1.63; 40 - 50 GHz	<0.004	1.8%, <18 GHz 2.5%, <40 GHz 3.5%, <50 GHz	N (m)
MA2473A	10 MHz - 32 GHz					K (m)
MA2474A	10 MHz - 40 GHz					K (m)
MA2475A	10 MHz - 50 GHz					V (m)
Fast thermal sensors						
MA2421B	0.1 MHz - 18 GHz	-30 to +20	<1.10; 0.1 MHz - 2 GHz <1.15; 2 - 12.4 GHz <1.20; 12.4 - 18 GHz <1.90; 10 - 50 MHz <1.17; 50 - 150 MHz <1.10; 0.15 - 2 GHz <1.15; 2 - 12.4 GHz <1.20; 12.4 - 18 GHz <1.25; 18 - 32 GHz <1.30; 32 - 40 GHz <1.40; 40 - 50 GHz	<4.0	1.3%, <18 GHz 1.5%, <40 GHz 1.8%, <50 GHz	N (m)
MA2422B	10 MHz - 18 GHz					N (m)
MA2423B	10 MHz - 32 GHz					K (m)
MA2424B	10 MHz - 40 GHz					K (m)
MA2425B	10 MHz - 50 GHz					V (m)
High accuracy diode sensors						
MA2442A	10 MHz - 18 GHz	-67 to +20	<1.90; 10 - 50 MHz <1.17; 50 - 150 MHz <1.08; 0.15 - 2 GHz <1.16; 2 - 12.4 GHz <1.21; 12.4 - 18 GHz <1.29; 18 - 32 GHz <1.44; 32 - 40 GHz <1.50; 40 - 50 GHz	<0.004	1.8%, <18 GHz 2.5%, <40 GHz 3.5%, <50 GHz	N (m)
MA2444A	10 MHz - 40 GHz					K (m)
MA2445A	10 MHz - 50 GHz					V (m)
Fast diode sensors						
MA2468A* ³	10 MHz - 6 GHz	-60 to +20	<1.90; 10 - 50 MHz <1.17; 50 - 150 MHz <1.12; 0.15 - 2 GHz <1.22; 2 - 12.4 GHz <1.25; 12.4 - 18 GHz	<0.0006	1.8%	N (m)
MA2469B* ³	10 MHz - 18 GHz					
Universal power sensors						
MA2481B	10 MHz - 6 GHz	-60 to +20	< 1.17; 10 - 150 MHz < 1.12; 0.15 - 2 GHz < 1.22; 2 - 12.4 GHz < 1.25; 12.4 - 18 GHz	<0.004 (with option 1 only)	10 MHz to 6GHz 3% -60 to +20 dBm 6 to 18 GHz 3% -60 to 0 dBm 3.5% 0 to +20 dBm (1.8% CW with option 1)	N (m)
MA2482A	10 MHz - 18 GHz					
MA2480/01	Adds fast CW mode to Universal Power Sensors for high speed measurements of CW signal plus TDMA and pulse measurements.					

*1: 0.0 dBm, room temperature.

*2: Each MA2400A/B series sensor incorporates precision RF connectors with hexagon coupling nut for attachment by industry standard torque wrench.

*3: MA2460A/B Fast Diode Sensors must be used with ML2407/08A Power Meters for NCDMA and Fast Pulse measurements.

Ordering information

Please specify model/order number, name, and quantity when ordering.

Model/Order No.	Name
ML2437A	Main frame Power Meter, single input
ML2438A	
ML2407A	
ML2408A	
	Power meter options
Option-1	
Option-3	
Option-5	
Option-6	
Option-7	
Option-8	
Option-9	
Option-11	
Option-12	
Option-13	
Option-20	
Option-21	
Option-22	
Option-23	
Option-24	
Option-25	
Option-26	
Option-27	
Option-29	
Option-33	
Option-98	
Option-99	

Options 1 to 5 are mutually exclusive for any given ML2430A unit. Options 6, 7, 8 and 9 above are mutually exclusive for any given ML2430A unit.

Model/Order No.	Name
	Power meter accessories
760-209	Hardside transit case
D41310	Soft carry case with shoulder strap
10585-00001	Extra operation manual for ML2430A series
10585-00003	Maintenance manual for ML2430A series
10585-00013	Power meter operations manual (for 2400A Sensors)
ML2419A	Range calibrator
MA2418A	Reference source
MA2499B	Anritsu Sensor Adaptor
MA2472A	Power Sensor 10 MHz to 18 GHz
MA2473A	Power Sensor 10 MHz to 32 GHz
MA2474A	Power Sensor 10 MHz to 40 GHz
MA2475A	Power Sensor 10 MHz to 50 GHz
MA2421A	Thermal Sensor 0.1 MHz to 18 GHz
MA2422B	Thermal Sensor 10 MHz to 18 GHz
MA2423B	Thermal Sensor 10 MHz to 32 GHz
MA2424B	Thermal Sensor 10 MHz to 40 GHz
MA2425B	Thermal Sensor 10 MHz to 50 GHz
MA2442A	High Accuracy Sensor 10 MHz to 18 GHz
MA2444A	High Accuracy Sensor 10 MHz to 40 GHz
MA2445A	High Accuracy Sensor 10 MHz to 50 GHz
MA2468A	Fast Diode Sensor 10 MHz to 6 GHz
MA2469B	Fast Diode Sensor 10 MHz to 18 GHz
MA2481B	Universal Power Sensor 10 MHz to 6 GHz
MA2482A	Universal Power Sensor 10 MHz to 18 GHz
	Sensor options & accessories
MA2497A	HP Sensor Adaptor
2300-243	LabView driver
MA2418A	50 MHz, 0 dBm remote calibration module
2000-933	12V DC power supply for MA2418A
ML2419A	Power Meter, range calibrator
MA2499B	Sensor Adapter (10 to 12 pin)
1N75C	5W Limiter, 0.01 to 3 GHz, Nm-f, 75 Ω
1N50C	5W Limiter, 0.01 to 18 GHz, Nm-f, 50 Ω
1K50A	5W Limiter, 0.01 to 20 GHz, Km-f, 50 Ω
1K50B	3W Limiter, 0.01 to 26 GHz, Km-f, 50 Ω
42N75-20	5 Watt attenuator, Nm-f, 75 Ω
42N50-20	5 Watt attenuator, Nm-f, 50 Ω
42N50-30	50 Watt attenuator, Nm-f, 50 Ω
42KC-20	5 Watt attenuator, Km-f, 50 Ω

ELECTRONIC VOLTMETER

ML69B

10 kHz to 1000 MHz

Popular High-Frequency VoltmeterCustom-made
product

The ML69B is a high-sensitivity, high-frequency electronic voltmeter using semiconductor diodes and a high-sensitivity chopper amplifier. It can measure high-frequency voltages ranging from 10 kHz to 1000 MHz with a full-scale sensitivity of 1 mV. It has a pen-type Probe MA61B, which can measure at high impedance with minimal effect on the device under test.

Features

- High input impedance
- Easy measuring operation
- Multipurpose usage with accessories
- DC output

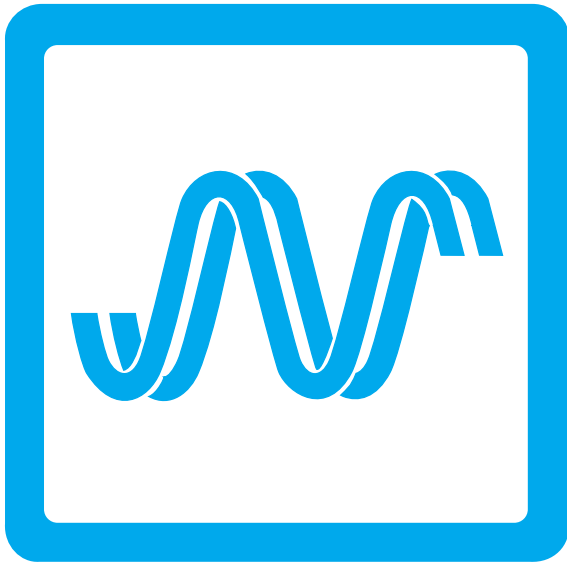

SIGNAL GENERATORS

Synthesized CW Generator	400
Synthesized Sweep Signal Generators	409
Synthesized Signal Generators	419, 424
Synthesizer/Level Generator	429
Synthesized Level Generator	429

SYNTHESIZED CW GENERATOR

MG3690A

0.1 Hz to 40 GHz

The Ideal Local Oscillator for RF and Microwave Applications

NEW



CE GPIB

A new synthesizer for a new millennium

The MG3690A leverages the proven design of the El Toro family of Anritsu synthesizers, adding new features to meet the latest needs of the new millennium. The El Toro platform gives the MG3690A excellent performance with a proven reliability record of greater-than 49,000 hours MTBF. This allows the MG3690A to offer a standard 3-year warranty. From the sleek new lines of the front panel, the larger 1/4 VGA LCD, the reduced front panel buttons and menu depth, to the 10 kg lighter and 15 cm shallower depth, the MG3690A meets the new millennium value-based needs.

Features

The 3690A basic signal sources provide accurate outputs over a wide frequency and power range for Local Oscillator duty and other CW applications.

- Broad frequency coverage including 0.1 Hz to 40 GHz in a single coax output
- Ultra-low SSB phase noise and spurious
- +17 dBm guaranteed leveled power to 20 GHz
- 0.01 Hz optional frequency resolution
- <5 ms switching time for <100 MHz sweep steps
- Digital frequency sweep and digital power sweep
- Wide dynamic range with accurate output levels
- Intuitive, menu-driven front panel

3 models, fully configurable, fully upgradable

- MG3692A 2 to 20 GHz
- MG3693A 2 to 30 GHz
- MG3694A 2 to 40 GHz

The MG3690A series offers three basic models that cover the frequency ranges of 2 to 20, 30, or 40 GHz. Options can easily be added to configure these models to meet your specific needs. As your needs change, your unit can be upgraded in frequency or options, minimizing your capital equipment investment risks. Option 3, Ultra-Low Phase Noise, adds high performance lock loops that deliver unrivaled phase noise performance. Options 4 and 5 add RF frequency coverage down to 10 MHz. Option 4 adds a Digital Down

Converter with the best RF phase noise performance. Option 5 adds an Analog Down Converter. For audio frequency coverage down to 0.1 Hz, Option 22 adds a Direct Digital Synthesizer. Option 13 offers external pulse capabilities. Check the last page of the brochure for the remaining traditional synthesizer options.

Automatic test equipment applications

The MG3690A is an ideal CW generator for an A.T.E. It packs the highest performance available in a 13.3 cm (3u) package, with a 450 mm depth that minimizes rack space. High output power assures adequate signal strength to the device under test even after A.T.E. switching and cabling losses. Accurately leveled output power to -120 dBm in 0.01 dB steps facilitates receiver sensitivity measurements. For improved MTBF, an electronic step attenuator replaces the traditional mechanical step attenuator. Fast 5 ms switching time maximizes system throughput. Internal list mode frees the A.T.E. controller to perform measurement analysis tasks. Free application drivers, including the IVI-COM driver and National Instruments LabView® drivers, save you time and money in code generation and maintenance. For additional cost savings, Option 17 eliminates the complete front panel including circuitry.

Interchangeable virtual instruments standard

The IVI standard defines a standard instrument driver model that enables instrument interchangeability and interoperability without software changes. Anritsu's IVI-driver supported synthesizer minimizes instrument development and maintenance cost through the use of IVI-standard interfaces as well as instrument-specific interfaces for unique instrument features. The IVI standard provides a single driver that supports the common application development environments such as Visual Basic, Visual C++, and Labview. The flexible I/O model supports new communication technologies such as USB, Ethernet, and Firewire. Anritsu Corporation leads the way with IVI technology, having released the first COM-based IVI driver supporting the Signal Generator instrument class, and includes the driver with every MG3690A series synthesizer. As an active member of the IVI Foundation, Anritsu supports the Foundation's drive toward instrument driver

Specifications

CW mode	Output	Twenty independent, presettable CW frequencies (F0 – F9 and M0 – M9)	
	Accuracy	Same as internal or external 10 MHz time base	
	Internal time base stability	With aging	$<2 \times 10^{-9}/\text{day}$ ($<5 \times 10^{-10}/\text{day}$ with Option 16)
		With temperature	$<2 \times 10^{-8}/^{\circ}\text{C}$ over 0°C to 55°C ($<5 \times 10^{-9}/^{\circ}\text{C}$ with Option 16)
	Resolution	0.01 Hz	
	External 10 MHz reference input	Accepts external 10 MHz ± 100 Hz, -10 to $+20$ dBm time base signal. Automatically disconnects the internal high-stability time-base option, if installed. BNC, rear panel, 50 ohm impedance	
	10 MHz reference output	0.5 Vp-p into 50 Ω , AC coupled. Rear panel BNC; 50 Ω impedance	
	Switching time (typical maximum)	<40 ms to be within 1 kHz of final frequency	
Phase offset	Adjustable in 0.1° steps		
Phase-locked step sweep mode	Sweep width	Independently selected, 0.01 Hz to full range. Every frequency step in sweep range is phase-locked	
	Accuracy	Same as internal or external 10 MHz time base	
	Resolution (minimum step size)	0.01 Hz	
	Linear/log sweep	User-selectable linear or log sweep. In log sweep, step size logarithmically increases with frequency	
	Steps	User-selectable number of steps or the step size	
	Number of Steps	Variable from 1 to 10,000	
	Step size	0.01 Hz to the full frequency range of the instrument. (If the step size does not divide into the selected frequency range, the last step is truncated.)	
	Dwell time per step	Variable from 1 ms to 99 seconds	
	Fixed rate sweep	Allows the user to set the total time of the sweep, including lock time. Variable from 20 ms to 99 seconds	
Switching time (typical maximum)	<15 ms + 1 ms/GHz step size or <40 ms, whichever is less, to be within 1 kHz of final frequency		
Alternate sweep mode	Sweeps alternately in step sweep between any two sweep ranges. Each sweep range may be associated with a power level		
Manual sweep mode	Provides stepped, phase-locked adjustment of frequency between sweep limits. User-selectable number of steps or step size		
List sweep mode	Under GPIB control or via the front panel, up to 4 tables with 2000 non-sequential frequency/power sets can be stored and then addressed as a phase-locked step sweep. One table of 2000 points is stored in non-volatile memory, all other tables are stored in volatile memory		
	Switching time (typical maximum)	<25 ms to be within 1 kHz of final frequency	
Programmable frequency agility	Under GPIB control, up to 3202 non-sequential frequency/power sets can be stored and then addressed as a phase-locked step sweep. Data is stored in volatile memory		
	Switching time (typical maximum)	<25 ms to be within 1 kHz of final frequency	
Markers	Up to 20 independent, settable markers (F0 – F9 and M0 – M9)		
	Video markers	+5V or -5 V marker output, selectable from system menus. AUX I/O connector, rear panel	
	Marker accuracy	Same as sweep frequency accuracy	
	Marker resolution	1 kHz (0.1 Hz with Option 11)	
Sweep triggering	Sweep triggering is provided for step frequency sweep, list frequency sweep, and CW power sweep		
	Auto	Triggers sweep automatically	
	External	Triggers a sweep on the low-to-high transition of an external TTL signal. AUX I/O connector, rear panel	
	Single	Triggers, aborts, and resets a single sweep. Reset sweep may be selected to be at the top or bottom of the sweep	

Continued on next page

General	Stored setups		Stores front panel settings and nine additional front-panel setups in a non-volatile RAM. A system menu allows for saving and recalling instrument setups. Whenever the instrument is turned on, control settings and values are the same as when last turned off
	Memory sequencing input		TTL low-level signal provides sequencing through ten stored setups. AUX I/O connector, rear panel
	Self-test		Instrument self-test is performed when Selftest soft-key is selected. If an error is detected, an error message is displayed in a window on the LCD identifying the probable cause and remedy
	Secure mode		Disables all frequency and power level state displays. Stored setups saved in secure mode remain secured when recalled. Mode selectable from a system menu and via GPIB
	Parameter entry		Instrument-controlled parameters can be entered in three ways—keypad, rotary data knob, or the "A" and "V" touch pads of the cursor-control key (use up/down-arrow symbol). The keypad is used to enter new parameter values; the rotary data knob and the cursor-control key are used to edit existing parameter values. The "<" and ">" touch pads of the cursor-control key move the cursor left and right one digit under the open parameter. The rotary data knob or the "<" and ">" touch pads will increment or decrement the digit position over the cursor. Controlled parameters are frequency, power level, sweep time, dwell time, and number of steps. Keypad entries are terminated by pressing the appropriate soft key. Edits are terminated by exiting the edit menu
	Reset		Returns all instrument parameters to predefined default states or values. Any pending GPIB I/O is aborted. Selectable from the system menu
	Master/slave operation		Allows two output signals to be swept with a user-selected frequency offset. One instrument controls the other via AUX I/O and SERIAL I/O connections. Requires a Master/Slave Interface Cable Set (Part No. ND36329)
	User level flatness correction		Provides compensation for path loss due to external switching and cables. Compensation may come from a power table in a GPIB power meter, or it may be from calculated data. When user level correction is activated, entered power levels are delivered at the point where calibration was performed. Supported power meters are Anritsu ML2437A, ML2438A, and ML4803A and HP 437B, 438A, and 70100A. Five user tables are available with up to 801 points/table
	Warm up time	From standby	30 minutes
		From cold start (0°C)	120 hours to achieve specified frequency stability with aging. Instruments disconnected from ac line power for more than 72 hours require 30 days to return to specified frequency stability with aging
	Power		90-264 Vac, 48-440 Hz, 250 VA maximum
	Standby		With AC line power connected, unit is placed in standby when front panel power switch is released from the OPERATE position
	Weight		14 kg maximum
Dimensions		133 H x 429 W x 450 D mm	
Remote operation	All instrument functions, settings, and operating modes (except for power on/standby) are controllable using commands sent from an external computer via the GPIB (IEEE-488 interface bus)		
	GPIB address		Selectable from a system menu
	IEEE-488 Interface Function Subset	Source handshake	SH1
		Acceptor handshake	AH1
		Talker	T6
		Listener	L4
		Service request	SR1
		Remote/local	RL1
		Parallel poll	PP1
		Device clear	DC1
		Device trigger	DT1
		Controller capability	C0, C1, C2, C3, C28
		Tri-state driver	E2
	GPIB Status Annunciators	When the instrument is operating in remote, the GPIB status annunciators (listed below) will appear in a window on the front panel display	
Remote		Under GPIB control (all instrument front panel keys except for the SYSTEM key and the RETURN TO LOCAL soft-key will be ignored)	
LLO (local lockout)		Disables the RETURN TO LOCAL soft-key. Instrument can be placed in local mode only via GPIB or by cycling line power	
Emulations		The instrument responds to the published GPIB commands and responses of the Anritsu Models 6600, 6700, and 6XX00-series signal sources. When emulating another signal source, the instrument will be limited to the capabilities, mnemonics, and parameter resolutions of the emulated instrument	
Environmental	Storage temperature range		-40 to +75°C
	Operating temperature range		0 to +50°C
	Relative humidity		5% to 95% at 40°
	Altitude		4,600 meters, 43.9 cm Hg
	EMI		Meets the emission and immunity requirements of EN55011:1991/CISPR-11:1990 Group 1 Class A EN50082-1:1997/ EN 61000-4-2:1995 – 4 kV CD, 8 kV AD EN61000-4-3:1997 – 3 V/m ENV50204 – 3 V/m EN61000-4-4: 1995 – 0.5 kV SL, 1 kV PL EN61000-4-5:1995 – 1 kV – 2 kV L-E MIL-STD-461C Part 2 REO1, REO2, CEO1, CEO3, CSO1, CSO2, CSO6, RSO3

Special purity

All specifications apply at the lesser of +10 dBm output or maximum specified leveled output power, unless otherwise noted.

Spurious signals

Harmonic and harmonic related

Frequency range	Standard
0.1 Hz to 10 MHz (Option 22)	<-30 dBc
10 MHz to ≤100 MHz (Option 4)	<-40 dBc
>100 MHz to ≤2.2 GHz (Option 4)	<-50 dBc
10 MHz to ≤50 MHz (Option 5)	<-30 dBc
>50 MHz to ≤2 GHz (Option 5)	<-40 dBc
>2 GHz (2.2 GHz w/Option 4) to ≤20 GHz	<-60 dBc
>20 GHz to ≤40 GHz	<-40 dBc

Harmonic and harmonic related (for models with Option 15, at maximum specified leveled output power)

Frequency range	Standard
10 MHz to ≤100 MHz (Option 4)	<-40 dBc
>100 MHz to ≤2.2 GHz (Option 4)	<-50 dBc
10 MHz to ≤50 MHz (Option 5)	<-30 dBc
>50 MHz to ≤2 GHz (Option 5)	<-40 dBc
>2 GHz (2.2 GHz w/Option 4) to ≤20 GHz	<-50 dBc
>20 GHz to ≤40 GHz	<-15 dBc*

* <-30 dBc typical >21 GHz

Nonharmonics

Frequency range	Standard
0.1 Hz to 10 MHz (Option 22)	<-30 dBc
10 MHz to ≤2.2 GHz (Option 4)	<-60 dBc
10 MHz to ≤2 GHz (Option 5)	<-40 dBc
>2 GHz (2.2 GHz w/Option 4) to ≤40 GHz	<-60 dBc

Power line and fan rotation spurious emissions (dBc)

Frequency range	Offset from carrier		
	<300 Hz	300 Hz to 1 kHz	>1 kHz
≥10 to ≤500 MHz (Option 4)	<-68	<-72	<-72
>500 to =1050 MHz (Option 4)	<-62	<-72	<-72
>1050 to ≤2200 MHz (Option 4)	<-56	<-66	<-66
≥0.01 to ≤8.4 GHz	<-50	<-60	<-60
>8.4 to ≤20 GHz	<-46	<-56	<-60
>20 to ≤40 GHz	<-40	<-50	<-54

Residual FM (CW and Step Sweep modes, 50 Hz - 15 kHz BW)

Frequency range	Residual FM (Hz RMS) option 3,4	Standard
≥0.01 to ≤8.4 GHz	<40	<120
>8.4 to ≤20 GHz	<40	<220
>20 to ≤40 GHz	<80	<440

AM noise floor

Typically <-145 dBm/Hz at 0 dBm output and offsets >5 MHz from carrier.

Single-sideband phase noise

Single-sideband phase noise (dBc/Hz)

Frequency range	Offset from carrier			
	100 Hz	1 kHz	10 kHz	100 kHz
≥0.1 Hz to <10 MHz (Option 22)	-90	-120	-130	-130
≥10 MHz to <500 MHz (Option 4)	-94	-106	-104	-120
≥500 MHz to <2200 MHz (Option 4)	-82	-94	-92	-108
≥10 MHz to <2 GHz (Option 5)	-77	-88	-86	-100
≥2 GHz to ≤6 GHz	-78	-88	-86	-102
>6 GHz to ≤10 GHz	-73	-86	-83	-102
>10 GHz to ≤20 GHz	-66	-78	-78	-100
>20 GHz to ≤40 GHz	-60	-75	-72	-94

Single-sideband phase noise (dBc/Hz) – Option 3

Frequency range	Offset from carrier					
	10 Hz	100 Hz	1 kHz	10 kHz	100 kHz	1 MHz
≥0.1 Hz to <10 MHz (Option 22)	-70	-90	-120	-130	-130	-130
≥10 MHz to <15.625 MHz (Option 4)	-101	-131	-140	-142	-141	-145
15.625 MHz to ≤31.25 MHz (Option 4)	-105	-125	-135	-137	-137	-145
>31.25 MHz to ≤62.5 MHz (Option 4)	-99	-119	-134	-136	-136	-144
>62.5 MHz to ≤125 MHz (Option 4)	-93	-113	-133	-135	-133	-144
>125 MHz to ≤250 MHz (Option 4)	-87	-107	-130	-132	-130	-143
>250 MHz to ≤500 MHz (Option 4)	-81	-101	-125	-128	-124	-142
>500 MHz to ≤1050 MHz (Option 4)	-75	-95	-119	-122	-119	-138
>1050 MHz to ≤2200 MHz (Option 4)	-69	-89	-113	-116	-113	-135
≥10 MHz to <2 GHz (Option 5)	-67	-83	-100	-102	-102	-111
≥2 GHz to ≤6 GHz	-60	-80	-107	-110	-107	-130
>6 GHz to ≤10 GHz	-55	-75	-104	-107	-107	-128
>10 GHz to ≤20 GHz	-49	-69	-98	-104	-102	-125
>20 GHz to ≤40 GHz	-43	-63	-92	-98	-96	-119

RF output

Power level specifications apply at 25 ±10°C.

Maximum leveled output power

Model number	Configuration	Frequency range (GHz)	Output power (dBm)	Output power with step attenuator (dBm)	Output power with electronic step attenuator (dBm)
MG3692A	With option 4	≤2.2 GHz	+17.0	+15.0	+13.0
	With option 5	≤2 GHz	+17.0	+15.0	+13.0
	Standard	>2 to ≤8.4 GHz	+13.0	+11.0	+9.0
	Standard	>8.4 to ≤20 GHz	+13.0	+11.0	+3.0
MG3693A	With option 4	≤2.2 GHz	+13.0	+11.0	Not available
	With option 5	≤2 GHz	+13.0	+11.0	
	Standard	>2 to ≤20 GHz	+9.0	+7.0	
	Standard	>20 to ≤30 GHz	+6.0	+3.0	
MG3694A	With option 4	≤2.2 GHz	+13.0	+11.0	Not available
	With option 5	≤2 GHz	+13.0	+11.0	
	Standard	>2 to ≤20 GHz	+9.0	+7.0	
	Standard	>20 to ≤40 GHz	+6.0	+3.0	

Maximum leveled output power with option 15 (high power) installed

Model number	Configuration	Frequency range (GHz)	Output power (dBm)	Output power with step attenuator (dBm)	Output power with electronic step attenuator (dBm)
MG3692A	With option 4	≤2.2 GHz	+19.0	+18.0	+15.0
	With option 5	≤2 GHz	+19.0	+18.0	+15.0
	Standard	>2 to ≤10 GHz	+19.0	+18.0	+13.0
	Standard	>10 to ≤20 GHz	+17.0	+15.0	+7.0
MG3693A	With option 4	≤2.2 GHz	+15.0	+14.0	Not available
	With option 5	≤2 GHz	+15.0	+14.0	
	Standard	>2 to ≤18 GHz	+15.0	+14.0	
	Standard	>18 to ≤20 GHz	+12.0	+10.0	
MG3694A	With option 4	≤2.2 GHz	+15.0	+14.0	Not available
	With option 5	≤2 GHz	+15.0	+14.0	
	Standard	>2 to ≤18 GHz	+15.0	+14.0	
	Standard	>18 to ≤20 GHz	+12.0	+10.0	
MG3694A	Standard	>20 to ≤40 GHz	+14.0	+12.0	

Leveled output power range	Standard units	Without an attenuator	Maximum leveled output power to -15 dBm (-20 dBm typical)
		With an attenuator	Maximum leveled output power to -120 dBm
		With an electronic attenuator	Maximum leveled output power to -140 dBm
	Units with option 15, high power	Without an attenuator	Maximum leveled output power to -5 dBm (-10 dBm typical)
		With an attenuator	Maximum leveled power to -115 dBm (-120 dBm typical). For units with Option 15A, minimum settable power is -105 dBm (-110 dBm typical)
		With an electronic attenuator	Maximum leveled power to -115 dBm (-110 dBm typical)
Unleveled output power range (typical)	Without an attenuator	>40 dB below max power	
	With an attenuator	>130 dB below max power	
Power level switching time (to within specified accuracy)	Without change in step attenuator	<3ms typical	
	With change in step attenuator	<20 ms typical	
	With change in electronic step attenuator	<3 ms typical. Power level changes across -70 dB step will result in 20 ms delay	

Accuracy and flatness	Accuracy specifies the total worst case accuracy. Flatness is included within the accuracy		
	Accuracy	±1.0 dB	
	Flatness	±0.8 dB	
Other output power specifications	Output units	Output units selectable as either dBm or mV. Selection of mV assumes 50 ohm load. All data entry and display are in the selected units	
	Output power resolution	0.01 dB or 0.001 mV	
	Source impedance	50 Ω nominal	
	Source SWR (internal leveling)	<2.0 typical	
	Power level stability with temperature	0.04 dB/°C typical	
	Level offset	Offsets the displayed power level to establish a new reference level	
	Output on/off	Toggles the RF output between an off and on state. During the off state, the RF oscillator is turned off. The on or off state is indicated by two LEDs located below the OUTPUT ON/OFF key on the front panel	
	RF on/off between frequency steps	System menu selection of RF on or RF off during frequency switching in CW, step sweep, and list sweep modes	
	RF on/off during retrace	System menu selection of RF on or RF off during retrace	
	Internal leveling	Power is leveled at the output connector in all modes	
External leveling	External detector	Levels output power at a remote detector location. Accepts a positive or negative 0.5 mV to 500 mV input signal from the remote detector. EXT ALC ADJ adjusts the input signal range to an optimum value. BNC connector, front and rear panel	
	External power meter	Levels output power at a remote power meter location. Accepts a ±1 V full scale input signal from the remote power meter. EXT ALC ADJ adjusts the input signal range to an optimum value. BNC connector, rear panel	
	External leveling bandwidth	30 kHz typical in detector mode. 0.7 Hz typical in power meter mode	
	User level flatness correction	Number of points: 2 to 801 points per table Number of tables: 5 available Entry modes: GPIB power meter or computed data	
CW power sweep	Range	Sweeps between any two power levels at a single CW frequency	
	Resolution	0.01 dB/step (Log) or 0.001 mV (Linear)	
	Accuracy	Same as CW power accuracy	
	Log/linear sweep	Power sweep selectable as either log or linear. Log sweep is in dB; linear sweep is in mV	
	Step size	User-controlled, 0.01 dB (Log) or 0.001 mV (Linear) to the full power range of the instrument	
	Step dwell time	Variable from 1 ms to 99 seconds. If the sweep crosses a step attenuator setting, there will be a sweep dwell of approximately 20 ms to allow setting of the step attenuator	
Sweep frequency/step power	A power level step occurs after each frequency sweep. Power level remains constant for the length of time required to complete each sweep		
External pulse modulation (option 13)	Pulse modulation specifications apply at maximum rated power, unless otherwise noted		
	On/off ratio	>80 dB	
	Rise/fall time (10 to 90%)	10 MHz to 1.0 GHz	15 ns (<10 ns typical)
		1.0 GHz to 40 GHz	10 ns (<5 ns typical)
	Minimum leveled pulse width	100 ns, ≤2 GHz 1 μs, <2 GHz	
	Minimum unleveled pulse width	10 ns	
	Pulse overshoot	10%	
	Level accuracy relative to CW (100 Hz to 1 MHz PRF)	±0.5 dB, ≥1 μs pulse width ±1.0 dB, <1 μs pulse width	
	Video feedthrough	<±10 mV, ≥2 GHz	
	Pulse width compression	<8 ns typical	
	Pulse delay (typical)	External mode	50 ns
		PRF range	DC to 10 MHz, unleveled 100 Hz to 5 MHz, leveled
	External input	Rear-panel BNC	
Drive level		TTL compatible input	
Input logic		Positive-true or negative-true, selectable from modulation menu	

Digital down (Option 4)

MG3690A synthesizers with option 4 DDC produce output frequencies from 10 MHz to 2.2 GHz by dividing the YTO frequency by 2 n. The divisor ranges from 2 at 2.2 GHz to 256 at 10-15.625 MHz.

Frequency range	Divide ratio, n
≥10 to ≤15.625 MHz	256
>15.625 to ≤31.25 MHz	128
>31.25 to ≤62.5 MHz	64
>62.5 to ≤125 MHz	32
>125 to ≤250 MHz	16
>250 to ≤500 MHz	8
>500 to ≤1050 MHz	4
>1050 to ≤2200 MHz	2

RF output	Frequency	10-2200 MHz
	Maximum leveled output power	+13 dBm, typically +19 dBm
Spectral purity	All specifications apply at +10 dBm output, unless otherwise noted	
	Harmonic and harmonic related	-40 dBc, ≤100 MHz -50 dBc, >100 MHz
	Non-harmonic spurious	-60 dBc
	AM noise	Typically -145 dBm/Hz at 0 dBm output and offsets >5 MHz from carrier

Power line and fan-related spurious (dBc)

Frequency range	Offset from carrier	
	<300 Hz	≥300 Hz
≥10 MHz to ≤500 MHz	-68	-72
>500 MHz to ≤1050 MHz	-62	-72
>1050 MHz to ≤2200 MHz	-56	-66

Pulse modulation	Pulse modulation specifications apply at maximum rated power, unless otherwise noted.	
	On/off ratio	>80 dB
	Minimum leveled pulse width	1 μsec
	Level accuracy relative to CW	± 0.5 dB (100 Hz to 500 kHz PRF)

Frequency range	Rise and fall time	Overshoot	Width compression	Video feedthrough
>500 to ≤2200 MHz	15 ns	10%	<12 ns*	±15 mV*
>125 to ≤500 MHz	<33 ns*	<11%*	<12 ns*	±70 mV*
>31.25 to ≤125 MHz	<90 ns*	<22%*	<12 ns*	±130 mV*
≥10 to ≤31.25 MHz	<400 ns*	<33%*	<40 ns*	±70 mV*

* Typical

Inputs and Outputs

Input/output connectors		
Nomenclature	Type	Location
PULSE TRIG IN I	BNC	Rear panel
EXT ALC IN	BNC	Rear panel
RF OUTPUT	K-Connector (female)	Standard-front panel option 9-rear panel
10 MHz REF IN	BNC	Rear panel
10 MHz REF OUT	BNC	Rear panel
HORIZ OUT	BNC	Rear panel
AUX I/O	25-pin D-type	Rear panel
SERIAL I/O	RJ45	Rear panel
IEEE-488 GPIB	Type 57	Rear panel

PULSE TRIG IN	Accepts an external TTL compatible signal to pulse modulate the RF output signal
EXT ALC IN	Provides for leveling the RF output signal externally with either a detector or power meter. Signal requirements are shown in the RF output specifications
RF OUTPUT	Provides for RF output from 50 Ω source impedance. K Connector, female. Option 9 moves the RF output connector to the rear panel
10 MHz REF IN	Accepts an external 10 MHz ±100 Hz, 0 to +10 dBm time-base signal. Automatically disconnects the internal high-stability time-base option, if installed. 50 Ω impedance
10 MHz REF OUT	Provides a 0.5 Vp-p, AC coupled, 10 MHz signal derived from the internal frequency standard. 50 Ω impedance
HORIZ OUT (horizontal sweep output)	Provides 0V at beginning and +10 V at end of sweep, regardless of sweep width. In CW mode, the voltage is proportional to frequency between 0 V at low end and +10 V at the high end of range. In CW mode, if CW RAMP is enabled, a repetitive, 0 V to +10 V ramp is provided
AUX I/O (auxiliary input/output)	Provides for most of the rear panel BNC connections through a single, 25-pin, D-type connector. Supports master-slave operation with another synthesizer or allows for a single-cable interface with the Model 56100A Scalar Network Analyzer and other Anritsu instruments
SERIAL I/O (serial input/output)	Provides access to RS-232 terminal ports to support service and calibration functions and master-slave operations
IEEE-488 GPIB	Provides input/output connections for the GPIB

Ordering information

Please specify model/order number, name, and quantity when ordering.

Model/Order No.	Name
	Models
MG3692A	2 – 20 GHz CW Generator
MG3693A	2 – 30 GHz CW Generator
MG3694A	2 – 40 GHz CW Generator
	Options and accessories
MG3690A/1A	Rack Mount with slides. Rack mount kit containing a set of track slides (90 degree tilt capability), mounting ears, and front panel handles to let the instrument be mounted in a standard 19-inch equipment rack.
MG3690A/1B	Rack Mount without slides. Modifies rack mounting hardware to install unit in a console that has mounting shelves. Includes mounting ears and front panel handles.
MG3690A/2x	Mechanical Step Attenuator. Adds a 10 dB/step attenuator with 110 dB range. Rated RF output power is reduced. (This option comes in different versions, based on the instrument configuration.)
MG3690A/2F	Electronic Step Attenuator – 20 GHz. Adds a 10 dB/step electronic attenuator with a 120 dB range for the MG3692A. Rated RF output power is reduced.
MG3690A/3	Ultra Low Phase Noise, main band, =2 GHz. Adds new modules to significantly reduce SSB Phase Noise
MG3690A/4	10 MHz to 2.2 GHz RF coverage, Ultra-Low Phase Noise version. Uses a digital down converter to significantly reduce SSB phase noise.
MG3690A/5	10 MHz to 2 GHz RF coverage. Uses an analog down converter.
MG3690A/9K	Rear Panel Output. Moves the RF output connector to the rear panel.
MG3690A/13	External Pulse Modulation. Rear panel BNC connector for connection of external pulse modulation signal
MG3690A/15x	High Power. Adds high-power RF components to the instrument to increase its output power level. (This option comes in different versions, based on the instrument configuration.)
MG3690A/16	High Stability Time Base. Adds an ovenized, 10 MHz crystal oscillator as a high-stability time base.
MG3690A/17	Delete Front Panel. Deletes the front panel for use in remote control applications where a front panel display and keyboard control are not needed.
MG3690A/18	mmW Bias Output. Adds a rear panel BNC Twinax connector to bias the 54000-xWRxx millimeter wave source modules.
MG3690A/22	0.1 Hz to 10 MHz Audio coverage. Uses a DDS for coverage down to approximately DC. When adding Option 22, the output power is degraded by 1 dB for frequencies ≤20 GHz and by 2 dB for frequencies >20 GHz.

Model/Order No.	Name
	Accessories
34RKNF50	DC to 20 GHz, Ruggedized Type N female adapter for units with a K connector output
ND36329	Master/Slave interface cable set
760-212A	Transit case
2300-469	IVI Driver, includes LabView © driver
806-97	Aux I/O cable, 25 pin to BNC: Provides BNC access to V/GHz and Sequential Sync connections and other AUX I/O data lines
	Millimeter wave accessories (requires MG3690A/18)
54000-4WR15	50 to 75 GHz, V band X4 multiplier-source module, (includes A36599 power cable and 3 filters).
54000-5WR15	50 to 75 GHz, V band X4 multiplier-source module with internal reference coupler/detector (includes A36599 power cable, 3 filters, and 560-10BX-2 detector adapter cable).
54000-4WR10	75-110 GHz, W band X6 multiplier-source module (includes A36599 power cable and 3 filters).
54000-5WR10	75-110 GHz, W band X6 multiplier-source module with internal reference coupler/detector (includes A36599 power cable, 3 filters, and 560-10BX-2 detector adapter cable).
N120-6	Semi-rigid cable, N(m) to N(m), 15 cm long, connects synthesizer's RF output to multiplier's RF input. (Also requires 34RKNF50 or 34RVNF50 Adapter).
	Upgrades
	Economical upgrades are available to upgrade any model to any higher performing model. Consult Anritsu for details.

SYNTHESIZED SWEEP SIGNAL GENERATOR

68000C, 69000B Series

0.1 Hz to 65 GHz

Microwave Synthesizer for Any Application



CE GPIB

Uncompromising value

You need a synthesizer that precisely fits your current needs yet can be upgraded, at a reasonable cost, to satisfy your future needs without shattering your test equipment budget. The 68C/69B family of synthesizers offers 42 models to fit any stimulus application including models with the lowest SSB phase noise and broadest frequency range available today. And the economical upgrades will continue to please your engineers and technicians... and your cost accounting department!

Anritsu offers CW generators, signal generators, and high-performance signal generators ideally suited to bench top or A.T.E. applications.

Features

- 36 models for perfect fit to any application
- Ultra-low SSB phase noise: -115 dBc typical at 10 kHz offset from 10 GHz
- 0.1 Hz to 65 GHz frequency coverage in a single coaxial output
- Waveguide extensions to 110 GHz
- Economical upgrades
- $+17$ dBm maximum power, -125 dBm minimum power
- Internal AM, FM, ϕ M, pulse modulation
- User down-loaded arbitrary modulation

Applications

• CW stimulus

The 69000B/68000C Synthesized CW Generators feature 10 MHz to 65 GHz frequency coverage. CW or step sweep, low SSB phase noise and spurious signals, output levels to $+17$ dBm, and optional 0.1 Hz resolution combine to make these sources ideal for local oscillator replacement applications. To meet requirements that expand over time, economical upgrades are available to any higher performing model. For the most demanding CW requirements, the 69000B and 68000C provide the ultimate in performance.

• Swept measurements

The 69100B/68100C Synthesized Signal Generators feature 10 MHz to 65 GHz analog, step, and manual sweep capability. The 69100B/68100C also provide AM/FM/pulse modulation via external modulating signals. Output levels to $+17$ dBm and optional 0.1 Hz

resolution are available at prices comparable to CW-only sources. To meet requirements that expand over time, economical upgrades are available to any higher performing model. Features, performance, and value combine to make the 69100B and 68100C the optimum sources for your network analysis and swept A.T.E. source applications.

• Complete synthesized modulation and sweep capabilities for any signal requirement

The 69300B/68300C Synthesized High Performance Signal Generators provide, in a single package, all the capabilities of our CW and signal generators, plus they contain an internal AM/FM/pulse modulation generator. The internal generators offer 7 modulating waveforms, including Gaussian noise, as well as user-defined arbitrary waveforms. Pulse modulation parameters can be set externally or by the internal pulse generator. Doublet, triplet, or quadruplet pulses make RADAR blind spot testing easy. The Swept Delay feature enables moving target simulation. Simultaneous synchronized modulations let you set complex signal scenarios across the entire 10 MHz to 65 GHz frequency range. The 69300B is the highest performance universal synthesized signal generator available today.

• One-box, ultra-clean RF and microwave signal solution

Every 69B series synthesizer model can be equipped with the new High Spectral Purity Digital Down Converter, which offers ultra-low SSB phase noise and harmonics in the 10 MHz to 2.2 GHz frequency range. The Digital Down Converter phase noise performance is typically 30-50 dB better than other microwave synthesizers and comparable to the best RF synthesizers in the market. Phase noise at 10 kHz offset from 500 MHz is typically -132 dBc/Hz and -140 dBc/Hz at 1 kHz from 125 MHz, which is comparable to a crystal oscillator! Typical harmonic levels are less than -45 dBc below 100 MHz and -55 dBc above 100 MHz.

The smart choice

The 69B series synthesizer continues to be the microwave synthesizer of choice for spectral purity and versatility. With the new state-of-the-art digital down converter, the synthesizers are true one-box, full-band solutions for ultra-clean RF and microwave signal generation, offering unrivaled performance in applications that previously required a separate RF synthesizer.

68C/69B synthesizers product selection table

Model	68000C	69000B	68100C	69100B	68300C	69300B
Ultra low σ noise		√		√		√
Step sweep	√	√	√	√	√	√
Analog sweep			√	√	√	√
Power sweep	√	√	√	√	√	√
Alternate sweep	√	√	√	√	√	√
Master/slave	√	√	√	√	√	√
AM			Ext	Ext	Int/Ext	Int/Ext
FM			Ext	Ext	Int/Ext	Int/Ext
σ M					Opt. 6	Opt. 6
Pulse modulation			Ext	Ext	Int/Ext	Int/Ext
AM scan (1 to 20 GHz)					Opt. 20	Opt. 20
Internal power meter					Opt. 8	Opt. 8

68C/69B synthesizers model summary

Frequency range	CW Generators		Signal Generators		High Performance Signal Generators	
0.01 to 8.4 GHz*	68017C	69017B	68117C	69117B	68317C	69317B
2 to 20 GHz	–		68137C	69137B	68337C	69337B
0.01 to 20 GHz*	–		68147C	69147B	68347C	69347B
0.01 to 40 GHz*	–		68167C	69167B	68367C	69367B
0.01 to 50 GHz*	68077C	69077B	68177C	69177B	68377C	69377B
0.01 to 60 GHz*	68087C	69087B	68187C	69187B	68387C	69387B
0.01 to 65 GHz*	68097C	69097B	68197C	69197B	68397C	69397B

*: Optional frequency extension down to 0.1 Hz is available

Specifications

Frequency	Mode	Output	Twenty independent, presettable CW frequencies (F0 to F9 and M0 to M9)
		CW mode	Accuracy
Phase-locked step sweep mode	Internal time base stability	With aging: $<2 \times 10^{-9}/\text{day}$ ($<5 \times 10^{-10}/\text{day}$ with Option 16) With temperature: $<2 \times 10^{-8}/^{\circ}\text{C}$ over 0°C ($<2 \times 10^{-10}/^{\circ}\text{C}$ with Option 16)	
	Resolution	1 kHz (0.1 Hz with Option 11)	
	Switching time (typical maximum)	Units with maximum frequency of ≥ 20 GHz: <40 ms to be within 1 kHz of final frequency Units with maximum frequency of 8.4 GHz: <15 ms to be within 1 kHz of final frequency	
	Analog sweep mode (68100C, 68300C, 69100B, 69300B)	Sweep width	Independently selected from 1 MHz to full range continuous sweep For 691XXB and 693XXB minimum frequency for analog sweep is 500 MHz
		Accuracy	The lesser of ± 30 MHz or (± 2 MHz widths) for sweep speeds of ≤ 50 MHz/ms
		Sweep time range	30 ms to 99 seconds
	Sweep width	Independently selected, 1 kHz (0.1 Hz with Option 11) to full range	
Accuracy	Same as internal or external 10 MHz time base		
Resolution (min. step size)	1 kHz (0.1 Hz with Option 11)		
Linear/log sweep	User-selectable linear or log sweep. In log sweep, step size logarithmically increases with frequency.		
Number of steps	Variable from 1 to 10,000		
Step size	1 kHz (0.1 Hz with Option 11) to the full frequency range of the instrument. (If the step size does not divide into the selected frequency range, the last step is truncated.)		
Step time	Step sweep: Variable from 1 ms/step to 99 seconds/steps. Dwell time begins after phase lock. Fixed rate step sweep: Variable from 20 ms/step to 99 seconds/step. Dwell time includes phase lock time.		
Switching time (typical maximum)	Units having a high-end frequency of ≥ 20 GHz: <15 ms + 1 ms/GHz step size or <40 ms, whichever is less Units having a high-end frequency of 8.4 GHz: <7 ms		
Alternate sweep mode	Sweeps alternately between any two sweep ranges. Each sweep range may be associated with a different power level.		
Manual sweep mode	Provides stepped, phase-locked adjustment of frequency between sweep limits. User-selectable number of steps or step size.		
List sweep mode	Tables	Under GPIB control or via the front panel, up to 4 tables with 2000 non-sequential frequencies/power sets can be stored and then addressed as a phase-locked step sweep. One table of 2000 points is stored in non-volatile memory, all other tables are stored in volatile memory.	
	Switching time (typical maximum)	Units having a high-end frequency of ≥ 20 GHz: <25 ms to be within 1 kHz of final frequency Units having a high-end frequency of 8.4 GHz: <5 ms to be within 1 kHz of final frequency	
Markers	Setting	Up to 20 independent, settable markers (F0 to F9 and M0 to M9)	
	Video markers	+5 V or -5 V marker output, selectable. AUX I/O connector, rear panel.	
	Intensity markers	Produces an intensified dot on trace, obtained by momentary dwell in RF sweep	

Continued on next page

		Frequency range	Standard		With Option 15	
Spectral purity*1	Spurious signals	Harmonic and harmonic related (dBc)	≥0.1 Hz to <10 MHz (Option 22)	-30	-30	-30
			≥10 MHz to ≤50 MHz	-30	-30	-30
			>50 MHz to <2 GHz	-40	-40	-40
			≥2 GHz to ≤20 GHz	-60	-50	-50
			>20 GHz to ≤40 GHz	-40	-40	-40
			50 GHz units >40 GHz to ≤50 GHz	-40	X	X
			60 GHz units >40 GHz to ≤60 GHz	-30	X	X
			65 GHz units >40 GHz to ≤65 GHz	-25	X	X
			Harmonic (Option 21)	≥10 MHz to 100 MHz	-40	-40
	100 MHz to 2.2 GHz	-50		-50	-50	
	Non-harmonic (dBc)	Frequency range	68XXXC	69XXXB	69XXXB	
		≥0.1 Hz to ≤10 MHz (Option 22)	-30	-30	-30	
		≥10 MHz to <2 GHz	-40	-40	-40	
		≥10 MHz to <2.2 GHz (Option 21)	-60	-60	-60	
		≥2 GHz to ≤65 GHz	-60	-60	-60	
Single-sideband phase noise, 69XXXB (dBc/Hz)	Frequency range	Offset from carrier				
		100 Hz	1 kHz	10 kHz	100 kHz	
	0.1 Hz to <10 MHz (Option 22)	-90	-120	-130	-130	
	≥10 MHz to <2 GHz	-83	-100	-102	-102	
	≥2 GHz to ≤6 GHz	-80	-107	-110	-107	
	>6 GHz ≤10 GHz	-75	-104	-107	-107	
	>10 GHz to ≤20 GHz	-69	-88	-104	-102	
	>20 GHz to ≤40 GHz	-63	-92	-98	-96	
	>40 GHz to ≤65 GHz	-57	-86	-92	-90	
	Single-sideband phase noise, 69XXXB (dBc/Hz) with Option 21	≥10 MHz to ≤125 MHz	-113	-133	-135	-133
		>125 MHz to ≤250 MHz	-107	-130	-132	-130
		>250 MHz to ≤500 MHz	-101	-125	-128	-124
		>500 MHz to ≤1050 MHz	-95	-119	-122	-119
		>1050 MHz to ≤2200 MHz	-89	-113	-116	-113
	Single-sideband phase noise, 68XXXC (dBc/Hz)	0.1 Hz to <10 MHz (Option 22)	-90	-120	-130	-130
≥10 MHz to <2 GHz		-77	-88	-86	-100	
≥2 GHz to ≤6 GHz		-78	-88	-86	-102	
>6 GHz ≤10 GHz		-73	-86	-83	-102	
>10 GHz to ≤20 GHz		-66	-78	-78	-100	
>20 GHz to ≤40 GHz		-60	-75	-72	-94	
>40 GHz to ≤65 GHz		-54	-69	-64	-88	

Continued on next page

Maximum leveled output power*2	Standard units	Model number	Frequency range (GHz)	Output power (dBm)	Output power with step attenuator (dBm)	Output power with electronic step attenuator (dBm)
		Option 21	10 MHz to 2.2 GHz	+13.0	+11.0	+9.0
		Option 22	≥0.1 Hz to <10 MHz	+13.0	+11.0	+9.0
		68X17C & 69X17B	≥0.1 to ≤8.4	+13.0	+11.0	+9.0
		68X37C & 69X37B	≥2 to ≤8.4 >8.4 to ≤20	+13.0 +13.0	+11.0 +11.0	+9.0 +3.0
		68X47C & 69X47B	≥0.01 to ≤8.4 >8.4 to ≤20	+13.0 +13.0	+11.0 +11.0	+9.0 +3.0
		68X67C & 69X67B	≥0.01 to <2 ≥2 to ≤20 >20 to ≤40	+13.0 +9.0 +6.0	+11.0 +7.0 +3.0	Not available
		68X77C & 69X77B	≥0.01 to <2 ≥2 to ≤20 >20 to ≤40 >40 to ≤50	+12.0 +10.0 +2.5 +2.5	+10.0 +8.5 0.0 -1.0	Not available
		68X87C & 69X87B	≥0.01 to <2 ≥2 to ≤20 >20 to ≤40 >40 to ≤50 >50 to ≤60	+12.0 +10.0 +2.5 +2.0 +2.0	+10.0 +8.5 0.0 -1.5 -2.0	Not available
		68X97C & 69X97B	≥0.01 to <2 ≥2 to ≤20 >20 to ≤40 >40 to ≤50 >50 to ≤65	+12.0 +10.0 +2.5 0.0 -2.0	Not available	Not available
With Option 15 (high power) installed	Model number	Frequency range (GHz)	Output power (dBm)	Output power with step attenuator (dBm)	Output power with electronic step attenuator (dBm)	
	68X17C & 69X17B	≥0.01 to <2 ≥2 to ≤8.4	+13.0 +17.0	+11.0 +15.0	+9.0 +11.0	
	68X37C & 69X37B	≥2 to ≤8.4 >8.4 to ≤20	+17.0 +17.0	+15.0 +15.0	+11.0 +7.0	
	68X47C & 69X47B	≥0.01 to <2 ≥2 to ≤8.4 >8.4 to ≤20	+13.0 +17.0 +17.0	+11.0 +15.0 +15.0	+9.0 +11.0 +7.0	
	68X67C & 69X67B	≥0.01 to ≤20 >20 to ≤40	+13.0 +6.0	+11.0 +3.0	Not available	

Continued on next page

RF output	Minimum leveled output power range	Standard units	Without an attenuator: Minimum leveled power to -20 dBm With an attenuator: Minimum leveled power to -120 dBm With an electronic attenuator: Minimum leveled power to -140 dBm				
		Units with Option 15, high power	Without an attenuator: Minimum leveled power to -10 dBm With an attenuator: Minimum leveled power to -110 dBm With an electronic attenuator: Minimum leveled power to -110 dBm				
	Power level switching time (to within specified accuracy)	Without change in step attenuator	<3 ms typical				
		With change in step attenuator	<20 ms typical				
		With change in electronic step attenuator	<3 ms typical: Power level changes across the -70 dB step will result in 20 ms delay				
	Accuracy and flatness (step sweep and CW modes)	Accuracy	Attenuation below max power	0.01 to 40 GHz	40 to 50 GHz	50 to 60 GHz	60 to 65 GHz
			0 to 25 dB	±1.0 dB	±1.5 dB	±1.5 dB	±1.5 dB
			25 to 60 dB	±1.0 dB	±1.5 dB	±3.5 dB typ.	-
		Flatness	>60 dB	±1.0 dB	±2.5 dB typ.	±3.5 dB typ.	-
			0 to 25 dB	±0.8 dB	±1.1 dB	±1.1 dB	±1.1 dB
25 to 60 dB			±0.8 dB	±1.1 dB	±3.1 dB typ.	-	
>60 dB	±0.8 dB	±2.1 dB typ.	±3.1 dB typ.	-			
Output units	Output units may be selected as either dBm or mV. Selection of mV assumes 50 Ω load. All data entry and display are in selected units.						
Output power resolution	0.01 dB (log) or 0.001 mV (linear)						
Level offset	Offsets the displayed power level to establish a new reference level						
CW power sweep	Range	Sweeps between any two power levels at a single CW frequency					
	Resolution	0.01 dB/step (log) or 0.001 mV (linear)					
	Accuracy	Same as CW power accuracy					
	Log/linear sweep	Power sweep selectable as either log or linear. Log sweep is in dB; linear sweep is in mV.					
	Step size	User-controlled, 0.01 dB (log) or 0.001 mV (linear) to the full power range of the instrument					
	Step dwell time	Variable from 1 ms to 99 seconds. If the sweep crosses a mechanical step attenuator setting, there will be a sweep dwell of approximately 20 ms to allow setting of the step attenuator.					
Sweep frequency/step power	A power level step occurs after each frequency sweep. Power level remains constant for length of time required to complete each sweep.						
Amplitude modulation*6	External AM input	Log AM or linear AM input, front- or rear-panel BNC, 50 Ω or 600 Ω input impedance. All options selectable from modulation menu.					
	AM sensitivity	Log AM: Continuously variable from 0 to 25 dB/V Linear AM: Continuously variable from 0 to 100%/V					
	AM depth (typical)	0 to 90% linear, 20 dB log					
	AM bandwidth (3 dB)	DC to 50 kHz minimum (DC to 100 kHz typical)					
	Maximum input	±1 V					
Frequency modulation	External FM input	Front- or rear-panel BNC, 50 Ω or 600 Ω input impedance All options selectable from modulation menu					
	External FM sensitivity*4	Continuously variable from ±10 kHz per volt to ±20 MHz per volt (locked and unlocked narrow modes), or ±100 kHz per volt to ±100 MHz per volt (unlocked wide mode)					
	Deviation*4	Unlocked wide: ±100 MHz, DC to 100 Hz rates Unlocked narrow: ±10 MHz, DC to 500 kHz rates Locked: The lesser of ±10 MHz or rate x 300, 1 kHz to 500 kHz rates					
	FM bandwidth (3 dB)	Unlocked wide: DC to 100 Hz Unlocked narrow: DC to 500 kHz Locked: 1 kHz to 500 kHz					
	Flatness	±1 dB (10 kHz to 500 kHz rates)					
	Accuracy	10% (5% typical, ±200 kHz deviation, 100 kHz rate)					
	Maximum input	±1 V					
Square wave modulation*5	On/off ratio	>50 dB					
	Rise/fall time	<1 μs typical					
	Internal square wave generator	Four square wave signals (400 Hz, 1 kHz, 7.8125 kHz, and 27.8 kHz), selectable from modulation menu Accuracy: Same as internal or external 10 MHz time base Square wave symmetry: 50% ±5% at all power levels					
	External input	Front- or rear-panel BNC, selectable from modulation menu Drive level: TTL compatible input Minimum pulse width: >5 μs Input logic: Positive-true or negative-true BNC, selectable from modulation menu					

Continued on next page

69300B/68300C modulation	Amplitude modulation*6	External AM input	Log AM or linear AM input, front or rear-panel BNC, 50 Ω or 600 Ω input impedance. All options selectable from modulation menu.
		AM sensitivity	Log AM: Continuously variable from 0 to 25 dB per volt Linear AM: Continuously variable from 0 to 100% per volt
		AM depth (typical)	0 to 90% linear; 20 dB log
		AM bandwidth	DC to 50 kHz minimum (DC to 100 kHz typical)
		Flatness	±0.3 dB (DC to 10 kHz rates)
		Accuracy	±5%
		Distortion	<5% typical
		Maximum input	±1 V
69300B/68300C modulation	Internal AM generator	Waveforms	Sinusoid, square, triangle, positive ramp, negative ramp, Gaussian noise, uniform noise, user-defined (Option 10)
		Rate	0.1 Hz to 1 MHz sinusoidal, 0.1 Hz to 100 kHz for other waveforms
		Resolution	0.1 Hz
		Accuracy	Same as instrument timebase
		Output	BNC connector, rear panel
	Frequency modulation	External FM input	Front- or rear-panel BNC, 50 Ω or 600 Ω input impedance All options selectable from modulation menu
		External FM sensitivity*4	Continuously variable from ±10 kHz per volt to ±20 MHz per volt (locked, locked low noise and unlocked narrow modes), or ±100 kHz per volt to ±100 MHz per volt (unlocked wide mode)
		Deviation*4	Unlocked wide: ±100 MHz, DC to 100 Hz rates Unlocked narrow: ±10 MHz, DC to 8 MHz rates Locked: The lesser of ±10 MHz or rate x 300, 1 kHz to 8 MHz rates Locked low noise: The lesser of ±10 MHz or rate x 3, 50 kHz to 8 MHz rates
		FM bandwidth (3 dB)	Unlocked wide: DC to 100 Hz Unlocked narrow: DC to 10 MHz Locked: 1 kHz to 10 MHz Locked low noise: 30 kHz to 10 MHz
		Flatness	±1 dB (10 kHz to 1 MHz rates)
		Accuracy	10% (5% typical, ±200 kHz deviation, 100 kHz rate)
		Maximum input	±1 V
	Internal FM generator	Waveforms	Sinusoid, square, triangle, positive ramp, negative ramp, Gaussian noise, uniform noise, user-defined (Option 10)
		Rate	0.1 Hz to 1 MHz sinusoidal, 0.1 Hz to 100 kHz for other waveforms
		Resolution	0.1 Hz
		Accuracy	Same as instrument timebase
		Output	BNC connector, rear panel
	Phase modulation (øM, Option 6)	øM deviation*4	Narrow mode (DC to 8 MHz rates): The lesser of ±3 radians or ±5 MHz/rate Wide mode (DC to 1 MHz rates): The lesser of ±400 radians or ±10 MHz/rate.
		øM bandwidth (3 dB, relative to 100 kHz rate) øM flatness (relative to 100 kHz rate)	Narrow mode: DC to 10 MHz Wide mode: DC to 1 MHz Narrow mode (DC to 1 MHz rates): ±1 dB
		øM accuracy	10% (at 100 kHz sine wave)
		External øM input	Front or rear panel BNC (shares the FM input), 50 Ω or 600 Ω input impedance. All options selectable from modulation menu. Shares connectors with FM.
		External øM sensitivity*4	Continuously variable from ±0.0025 to ±5 radians per volt (narrow øM mode) or ±0.25 to ±500 radians per volt (wide øM mode), selectable from modulation menu
		External øM maximum input	±1 V
Internal øM generator (shares the internal FM generator)		Waveforms	Sine, square, triangle, positive ramp, negative ramp, Gaussian noise, uniform noise, user defined (Option 10)
	Rate	0.1 Hz to 1 MHz for sine wave, 0.1 Hz to 100 kHz for other waveforms	
	Resolution	0.1 Hz	
	Accuracy	Same as instrument timebase	
	Output	BNC connector, rear panel	
Pulse modulation*7	On/off ratio	>80 dB	
	Rise/fall time (10 to 90%)	10 MHz to 1.0 GHz: <15 ns (<10 ns typical) 1.0 GHz to 65 GHz: <10 ns (<5 ns typical)	
	Minimum levelled pulse width	<100 ns (≥2 GHz), <1 μs (<2 GHz)	
	Minimum unlevelled pulse width	<10 ns	
	Pulse overshoot	<10% (for 50, 60 and 65 GHz units, overshoot from 40 to 65 GHz is 20% typical)	
	Level accuracy relative to CW	±0.5 dB (≥1 μs pulse width), ±1.0 dB (<1 μs pulse width) 100 Hz to 1 MHz PRF	
	PRF range	DC to 10 MHz unlevelled, 100 Hz to 5 MHz levelled	
	External input	Front- or rear-panel BNC, selectable from modulation menu Drive level: TTL compatible input Input logic: Positive-true or negative-true, selectable from modulation menu	

Continued on next page

69300B modulation	Internal pulse generator	Frequency (selectable clock rate)	40 MHz	10 MHz	
		Pulse width	25 ns to 419 ms	100 ns to 1.6 s	
		Pulse period	250 ns to 419 ms	600 ns to 1.6 s	
		Variable delay	Singlet	0 to 419 ms	0 to 1.6 s
			Doublet	100 ns to 419 ms	300 ns to 1.6 s
			Triplet	100 ns to 419 ms	300 ns to 1.6 s
			Quadruplet	100 ns to 419 ms	300 ns to 1.6 s
		Resolution	25 ns	100 ns	
		Modes	Free-run, triggered, gated, delayed, singlet, doublet, triplet, quadruplet		
	Accuracy	10 ns (5 ns typical)			
	Outputs	Video pulse and sync out, rear-panel BNC connectors			
	SCAN modulator (Option 20, 6X337C and 6X347C only)	Frequency range	1 to 20 GHz		
		Attenuation range*8	0 to 60 dB		
		Flatness	±2 dB (0 to 40 dB), ±3.5 dB (40 to 60 dB)		
Step response		<1 µs			
Sensitivity		-10 dB/V			
Insertion loss (when engaged)		<6 dB (1 to 18 GHz), <8 dB (18 to 20 GHz)			
Input		Rear-panel BNC (f) connector			
Remote operation*9	GPIO address	Selectable from a system menu			
	IEEE-488 interface function subset	SH1, AH1, T6, L4, SR1, RL1, PP1, DC1, DT1, C0, C1, C2, C3, C28, E2			
	Emulations	The instrument responds to the published GPIB commands and responses of the models 6XX00-series signal sources. When emulating another signal source, the instrument is limited to the capabilities, mnemonics, and parameter resolutions of the emulated instrument.			
General	Stored setups	Stores front-panel settings and nine additional front-panel setups in a non-volatile RAM. A system menu allows saving and recalling of instrument setups. Whenever the instrument is turned on, control settings come on at the same functions and values existing when the instrument was turned off.			
	Memory sequencing input	Accepts a TTL low-level signal to sequence through nine stored setups. AUX I/O connector, rear panel.			
	Self-test	Instrument self-test is performed when SELF TEST soft-key is selected. If an error is detected, an error message is displayed in a window on the LCD identifying the probable cause.			
	Secure mode	Disables all frequency, power level, and modulation state displays. Stored setups saved in secure mode remain secured when recalled. Mode selectable from a system menu and GPIB.			
	Reset	Returns instrument parameters to predefined default states or values. Any pending GPIB I/O is aborted. Selectable from the system menu.			
	Master/slave operation	Allows two 68xxxC or 69xxxB output signals to be swept with a user-selected frequency offset. One unit controls the other via AUX I/O and SERIAL I/O connections. Requires MASTER/SAVE interface cable set (part no. ND36329).			
	User level flatness correction	Allows user to calibrate out-path loss due to external switching and cables via entered power table from a GPIB power meter or calculated data. When user level correction is activated, entered power levels are delivered at the point where calibration was performed. Supported power meters are Anritsu ML4803A and HP437B, 438A, and 70100A. Five user tables are available at up to 801 points/table.			
	Power	90 to 132 Vac or 180 to 264 Vac, 49 to 440 Hz, ≤400 VA			
	Standby	With AC line power connected, unit is placed in standby when front-panel power switch is released from the OPERATE position			
	Dimensions and mass	429 (W) x 133 (H) x 597 (D) mm [5.25 (H) x 16.875 (W) x 23.5 (D) in.], ≤23 kg (50 lb)			
RF output connector	Type K female (≤40 GHz models); Type V female (>40 GHz models)				

*1: All specifications apply to the phase-locked CW and step sweep modes at the lesser of +10 dBm output or maximum specified leveled output power, unless otherwise noted.

*2: Specifications apply at 25°C ±10°C.

*3: >40 GHz units and units with Option 15 at maximum specified leveled output power.

*4: For 69XXXB units, maximum sensitivity, maximum deviation, and maximum modulation are reduced.

*5: The RF output can be pulse modulated via an external modulating signal or an internal square wave generator.

*6: All amplitude modulation specifications apply at 50% depth, 1 kHz rate, with RF level set 6 dB below maximum specified leveled output power, unless otherwise noted.

*7: All pulse modulation specifications apply at maximum specified leveled output power, unless otherwise noted.

*8: Maximum attenuation = attenuation ±flatness.

*9: All instrument functions, settings, and operating modes (except for power on/standby) are controllable using commands sent from an external computer via the GPIB (IEEE-488) interface bus.

Digital downconverter specifications

FM/ΦM specifications:

69B synthesizers with Option 21 DDC produce output frequencies from 10 MHz to 2.2 GHz by dividing the YTO frequency by 2^n . The divisor ranges from 2 at 2.2 GHz to 256 at 10-15.625 MHz. In FM and ΦM modes, FM deviation is divided as well, so deviation at the YTO is greater than at the RF output.

Frequency range	Divide ratio, n
≥ 10 to ≤ 15.625 MHz	256
> 15.625 to ≤ 31.25 MHz	128
> 31.25 to ≤ 62.5 MHz	64
> 62.5 to ≤ 125 MHz	32
> 125 to ≤ 250 MHz	16
> 250 to ≤ 500 MHz	8
> 500 to ≤ 1050 MHz	4
> 1050 to ≤ 2200 MHz	2

Frequency modulation (for 691xxB):

Parameter	Modes	Conditions	Specification
Deviation	Locked Unlocked Narrow Unlocked Wide	Rate = 1 Hz to (Lesser of 500 kHz or $0.03^* F_{carrier}$) Rate = DC to (Lesser of 500 kHz or $0.03^* F_{carrier}$) Rate = DC to 100 Hz	\pm [Lesser of 10 MHz or 300 (mod rate)]/n \pm (10 MHz)/n \pm (100 MHz)/n
Bandwidth (3 dB)	Locked Unlocked Narrow Unlocked Wide	100 kHz rate 100 kHz rate DC rate	1 kHz to (Lesser of 500 kHz or $0.03^* F_{carrier}$) DC to (Lesser of 500 kHz or $0.03^* F_{carrier}$) DC to 100 Hz
Flatness	Locked	Rate = 10 kHz to (Lesser of 500 kHz or $0.01^* F_{carrier}$)	± 1 dB relative to 100 kHz rate
Accuracy	Locked and Unlocked Narrow	Rate = 100 kHz, Sinewave, Int. or 1 Vpk Ext.	10% (5% typical)
External sensitivity	Locked and Unlocked Narrow Unlocked Wide		\pm (10 kHz/V to 20 MHz/V)/n \pm (100 kHz/V to 100 MHz/V)/n

Frequency modulation (for 693xxB):

Parameter	Modes	Conditions	Specification
Deviation	Locked Locked Low-noise Unlocked Narrow Unlocked Wide	Rate = 1 kHz to (Lesser of 8 MHz or $0.03^* F_{carrier}$) Rate = 50 kHz to Lesser of 8 MHz or $0.03^* F_{carrier}$) Rate = DC to (Lesser of 8 MHz or $0.03^* F_{carrier}$) Rate = DC to 100 Hz	\pm [Lesser of 10 MHz or $300^*(\text{mod rate})$]/n \pm [Lesser of 10 MHz or $3^*(\text{mod rate})$]/n \pm (10 MHz)/n \pm (100 MHz)/n
Bandwidth (3 dB)	Locked Locked Low-noise Unlocked Narrow Unlocked Wide	100 kHz rate 100 kHz rate 100 kHz rate DC rate	1 kHz to (Lesser of 10 MHz or $0.03^* F_{carrier}$) 30 kHz to (Lesser of 10 MHz or $0.03^* F_{carrier}$) DC to (Lesser of 10 MHz or $0.03^* F_{carrier}$) DC to 100 Hz
Flatness	Locked	Rate = 10 kHz to (Lesser of 1 MHz or $0.01^* F_{carrier}$)	± 1 dB relative to 100 kHz
Accuracy	Locked and Low-noise Unlocked Narrow	Rate = 100 kHz, Sinewave, Int. or 1 Vpk Ext.	10% (5% typical)
Incidental AM	Locked, Low-noise, Unlocked Narrow	Rate and Dev.= Lesser of 1 MHz or $0.01^* F_{carrier}$	<2% typical
Harmonic distortion	Locked	Rate = 10 kHz, Dev.= \pm (1 MHz)/n	<1%
External sensitivity	Locked Locked Low-noise Unlocked Narrow Unlocked Wide		\pm (10 kHz/V to 20 MHz/V)/n \pm (100 kHz/V to 100 MHz/V)/n

Phase modulation:

Parameter	Modes	Conditions	Specification
Deviation	Narrow Wide	Rate = DC to (Lesser of 8 MHz or $0.03^* F_{carrier}$) Rate = DC to (Lesser of 1 MHz or $0.03^* F_{carrier}$)	\pm [Lesser of 3 rad or (5 MHz)/(mod rate)]/n \pm [Lesser of 400 rad or (10 MHz)/(mod rate)]/n
Bandwidth (3 dB)	Narrow Wide	100 kHz rate 100 kHz rate	DC to (Lesser of 10 MHz or $0.03^* F_{carrier}$) DC to (Lesser of 1 MHz or $0.03^* F_{carrier}$)
Flatness	Narrow Wide	Rate = DC to (Lesser of 1 MHz or $0.01^* F_{carrier}$) Rate = DC to (Lesser of 500 kHz or $0.01^* F_{carrier}$)	± 1 dB relative to 100 kHz rate ± 1 dB relative to 100 kHz rate
Accuracy	Narrow and Wide	100 kHz, Int. or 1 Vpk Ext., sine	10%
External sensitivity	Narrow Wide		\pm (0.0025 rad/V to 5 rad/V)/n \pm (0.25 rad/V to 500 rad/V)/n

Digital downconverter specifications (Option 21)

RF output

Frequency: 10 to 2200 MHz

Maximum leveled output power: +13 dBm, typically +19 dBm

Spectral purity

All specifications apply at +10 dBm output, unless otherwise noted.

Harmonic and harmonic related:

-40 dBc, ≤100 MHz

-50 dBc, >100 MHz

Non-harmonic spurious:

-60 dBc

AM noise:

Typically -145 dBm/Hz at 0 dBm output and offsets >5 MHz from carrier.

Power line and fan-related spurious (dBc):

Frequency Range	Offset from Carrier	
	<300 Hz	≥300 Hz
≥10 MHz to ≤500 MHz	-68	-72
>500 MHz to ≤1050 MHz	-62	-72
>1050 MHz to ≤2200 MHz	-56	-66

Pulse modulation

On/off ratio: >80 dB

Minimum leveled pulse width: 1 msec

Level accuracy relative to CW (100 Hz to 500 kHz PRF): ±0.5 dB

Frequency range	Rise and fall time	Overshoot	Width compression	Video feedthrough
>500 to ≤2200 MHz	15 ns	10%	12 ns*	±15 mV*
>125 to ≤500 MHz	<33 ns*	<11%*	12 ns*	±70 mV*
>31.25 to ≤125 MHz	<90 ns*	<22%*	12 ns*	±130 mV*
≥10 to ≤31.25 MHz	<400 ns*	<33%*	<40 ns*	±70 mV*

*: Typical

Ordering Information

Please specify model/order number, name, and quantity when ordering.

Model/Order No.	Name
Main frame	
69017B	Ultra Low Noise Synthesized CW Generator (0.01 to 8.4 GHz)
69077B	Ultra Low Noise Synthesized CW Generator (10 MHz to 50 GHz)
69087B	Ultra Low Noise Synthesized CW Generator (10 MHz to 60 GHz)
69097B	Ultra Low Noise Synthesized CW Generator (10 MHz to 65 GHz)
69117B	Ultra Low Noise Synthesized Signal Generator (0.01 to 8.4 GHz)
69137B	Ultra Low Noise Synthesized Signal Generator (2 to 20 GHz)
69147B	Ultra Low Noise Synthesized Signal Generator (10 MHz to 20 GHz)
69167B	Ultra Low Noise Synthesized Signal Generator (10 MHz to 40 GHz)
69177B	Ultra Low Noise Synthesized Signal Generator (10 MHz to 50 GHz)
69187B	Ultra Low Noise Synthesized Signal Generator (10 MHz to 60 GHz)
69197B	Ultra Low Noise Synthesized Signal Generator (10 MHz to 65 GHz)
69317B	Ultra Low Noise High Performance Synthesized Signal Generator (0.01 to 8.4 GHz)
69337B	Ultra Low Noise High Performance Synthesized Signal Generator (2 to 20 GHz)
69347B	Ultra Low Noise High Performance Synthesized Signal Generator (10 MHz to 20 GHz)
69367B	Ultra Low Noise High Performance Synthesized Signal Generator (10 MHz to 40 GHz)
69377B	Ultra Low Noise High Performance Synthesized Signal Generator (10 MHz to 50 GHz)
69387B	Ultra Low Noise High Performance Synthesized Signal Generator (10 MHz to 60 GHz)
69397B	Ultra Low Noise High Performance Synthesized Signal Generator (10 MHz to 65 GHz)
68017C	Synthesized CW Generator (0.01 to 8.4 GHz)
68077C	Synthesized CW Generator (10 MHz to 50 GHz)
68087C	Synthesized CW Generator (10 MHz to 60 GHz)
68097C	Synthesized CW Generator (10 MHz to 65 GHz)
68117C	Synthesized Signal Generator (0.01 to 8.4 GHz)
68137C	Synthesized Signal Generator (2 to 20 GHz)
68147C	Synthesized Signal Generator (10 MHz to 20 GHz)
68167C	Synthesized Signal Generator (10 MHz to 40 GHz)
68177C	Synthesized Signal Generator (10 MHz to 50 GHz)
68187C	Synthesized Signal Generator (10 MHz to 60 GHz)
68197C	Synthesized Signal Generator (10 MHz to 65 GHz)
68317C	High Performance Synthesized Signal Generator (0.01 to 8.4 GHz)
68337C	High Performance Synthesized Signal Generator (2 to 20 GHz)
68347C	High Performance Synthesized Signal Generator (10 MHz to 20 GHz)
68367C	High Performance Synthesized Signal Generator (10 MHz to 40 GHz)
68377C	High Performance Synthesized Signal Generator (10 MHz to 50 GHz)
68387C	High Performance Synthesized Signal Generator (10 MHz to 60 GHz)
68397C	High Performance Synthesized Signal Generator (10 MHz to 65 GHz)

Continued on next page

Model/Order No.	Name
	Options
Option 1	Rack mounting: Rack mount kit containing a set of track slides (90° tilt capability), mounting ears, and front-panel handles to let the instrument be mounted in a standard 19 inch equipment rack
Option 2A	110 dB step attenuator: Adds a 10 dB/step attenuator with 110 dB range for models having a high-end frequency of ≤20 GHz. Rated RF output power is reduced.
Option 2B	110 dB step attenuator: Adds a 10 dB/step attenuator with 110 dB range for models having a high-end frequency of ≤40 GHz. Rated RF output power is reduced.
Option 2C	90 dB step attenuator: Adds a 10 dB/step attenuator with 90 dB range for models having a high-end frequency of ≤50 GHz. Rated RF output power is reduced.
Option 2D	90 dB step attenuator: Adds a 10 dB/step attenuator with 90 dB range for models having a high-end frequency of ≤60 GHz. Rated RF output power is reduced.
Option 2E	120 dB electronic step attenuator: Adds a 10 dB/step electronic attenuator with a 120 dB range for models having a high-end frequency of ≤8.4 GHz. Rated RF output power is reduced.
Option 2F	120 dB electronic step attenuator: Adds a 10 dB/step electronic attenuator with a 120 dB range for models having a high-end frequency of ≤20 GHz. Rated RF output power is reduced.
Option 6	Phase modulation (ΦM) (683xxC and 693xxB): Provides phase modulation capability. FM input, FM output and FM generator become FM/ΦM input, FM/ΦM output and FM/ΦM generator.
Option 7	Delete AM/FM generators (683xxC and 693xxB): Deletes the internal AM and FM generators. External AM and FM capability remains unchanged. (Not available in combination with Option 8 or Option 20.)
Option 8	Internal power meter (683xxC and 693xxB): Adds an internal power meter that is compatible with Anritsu 560-7, 5400-71, or 6400-71 series detectors. (Not available in combination with Option 7.)
Option 9	Rear panel RF output: Moves RF output connector to the rear panel
Option 10	Complex modulation capability (683xxC and 693xxB): Provides user-defined waveform capability for complex modulation. Requires controller (not included). Includes cable and Windows® based software
Option 11	0.1 Hz frequency resolution: Provides frequency resolution of 0.1 Hz
Option 14	Rack mounting without chassis slides: Modifies rack mounting hardware to install unit in a console that has mounting shelves
Option 15A	High power output (680xxC, 681xxC, 690xxB and 691xxB): Adds high-power RF components to the instrument in the 2 to 20 GHz frequency range
Option 15B	High power output (683xxC and 693xxB): Adds high-power RF components to the instrument in the 2 to 20 GHz frequency range
Option 16	High stability time base: Adds an ovenized, 10 MHz crystal oscillator as a high-stability time base. Derate phase noise specification at 10 Hz offset by 8 dB.
Option 17A	Delete front panel (691xxB and 693xxB): Deletes the front panel for use in remote control applications where a front-panel display and keyboard control are not needed
Option 17B	Delete front panel (690xxB): Deletes the front panel for use in remote control applications where a front-panel display and keyboard control are not needed

Model/Order No.	Name
Option 18	mmWave bias output: Adds rear-panel bias output to drive 54000-xWRxx millimeter wave source modules. BNC Twinax connector. (Not available in combination with Option 20.)
Option 19	SCPI programmability: Adds GPIB command mnemonics complying with Standard Commands for Programmable Instruments (SCPI), Version 1993.0. SCPI programming complies with IEEE 488.2–1987.
Option 20	SCAN modulator: Adds an internal SCAN modulator for simulating high-depth amplitude modulated signals in models 69337B, 69347B, 68337C and 68347C only. Requires an external modulating signal input. (Not available in combination with Option 7, Option 18, or Option 22.)
Option 21	High spectral purity down converter: Adds CW, sweep, and pulse modulation frequency coverage from 10 MHz to 2.2 GHz for models having a low-end frequency of 10 MHz. Provides ultra-low phase noise harmonics.
Option 22	0.1 Hz to 10 MHz audio frequency: Adds CW and step sweep frequency coverage below 10 MHz for models having a low-end frequency of 10 MHz. Covers frequencies down to 0.1 Hz with Option 11 or 1 kHz without Option 11. (Not available with Option 20.)
	Accessories
34RKNF50	Ruggedized K-to-Type N female adapter, DC to 20 GHz
34RVNF50	Ruggedized V-to-Type N female adapter, DC to 20 GHz
34VKF50	V male-to-K female Precision Adapter, DC to 46 GHz,
ND36329	MASTER/SLAVE interface cable set
D37178-2	Protective front panel cover
760-177	Transit case
2300-218	Anritsu power tools: Provides comprehensive interface dll's to be used as drivers for any Windows® based application. Includes driver for National Instruments LabView® and complex modulation interface software.
806-90	Aux I/O interface cable
	Millimeter wave accessories
54000-4WR15	50 to 75 GHz, V band X4 multiplier-source module (includes A36599 power cable and 3 filters)
54000-5WR15	50 to 75 GHz, V band X4 multiplier-source module with internal reference coupler/detector (includes A36599 power cable, 3 filters, and 560-10BX-2 detector adapter cable)
54000-4WR10	75 to 110 GHz, W band X6 multiplier-source module with internal reference coupler/detector (includes A36599 power cable and 3 filters)
54000-5WR10	75 to 110 GHz, W band X6 multiplier-source module with internal reference coupler/detector (includes A36599 power cable, 3 filters, and 560-10BX-2 detector adapter cable)
N120-6	Semi-rigid cable, N (m) to N (m), 6 inches long, connects synthesizer's RF output to multiplier's RF input. (Also requires 34RKNF50 or 34RVNF50 Adapter.)
	Upgrades
	Economical upgrades are available to upgrade any model to any higher performing model or to upgrade 68xxxC synthesizers to 69xxxB synthesizers. Consult Anritsu for details.

SYNTHESIZED SIGNAL GENERATOR
MG3641A/MG3642A

125 kHz to 1040/2080 MHz

Economic High-Performance Signal Sources



New Anritsu synthesizer technology permits frequency to be set with a resolution of 0.01 Hz across the full frequency range, and the non-harmonic spurious is better than -100 dBc for reliable measurement at any frequency. A unique low-noise YIG oscillator produces a high-purity signal with SSB phase noise of better than -130 dBc/Hz (1 GHz, 20 kHz offset) making these signal generators for interference testing of radio receivers and as sources for various local and reference signals.

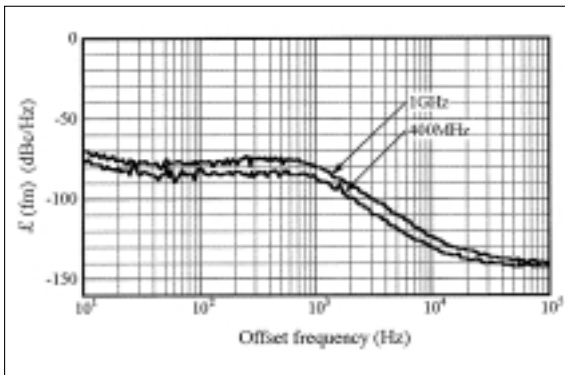

SSB phase noise characteristic

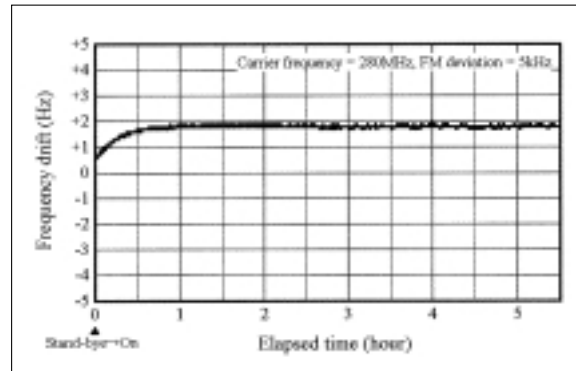

Carrier wave frequency stability at frequency modulation

• High output

A stable signal with an output of +17 dBm can be output across the full frequency range to drive a variety of local signal sources and power amplifiers. In addition, an overdrive level up to +23 dBm can be set so as to make full use of the internal amplifier capability. If the amplifier's output power comes up to the limitation and output power does not reach the set value, a status message is displayed. This is useful for confirming the output limits.

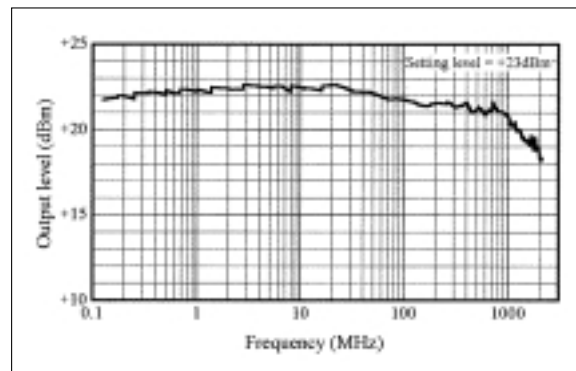

Maximum output level

Features

- 0.01 Hz, 0.01 dB setting resolution
- High signal purity (-100 dBc spurious)
- Versatile modulation functions

Performance

• High-stable carrier frequency

Carrier frequency is produced by a high-stability crystal oscillator. Furthermore, the carrier frequency remains phase locked even at frequency modulation. Then frequency calibration for testing FSK modulation receivers such as paging system is not necessary.

• Various modulation types

Up to three internal AF signal sources can be incorporated by adding options to the standard sine-wave oscillator (1 kHz, 400 Hz). The AF synthesizer (Option 21) is a digital synthesizer for generating sine-wave, triangular, square, and sawtooth waveforms; it can also be used as a function generator as well as a modulation signal source. In addition to permitting simultaneous one-route AM and two-route FM modulation, the modulation factor and polarity can be set independently. Installing the pulse modulator (Option 11) in the MG3641A/

3642A allows them to generate high-speed pulse modulation using an external modulation signal (TTL level). The output can be used for various burst signals with an ON/OFF ratio of more than 80 dB, as well as a pseudo-random signal for radar. Installing the pattern generator (Option 23) in the MG3641A/3642A allows them to generate FSK or pulse modulation combined with FSK encoder (Option 22) or pulse modulator (Option 11) without an external instrument.

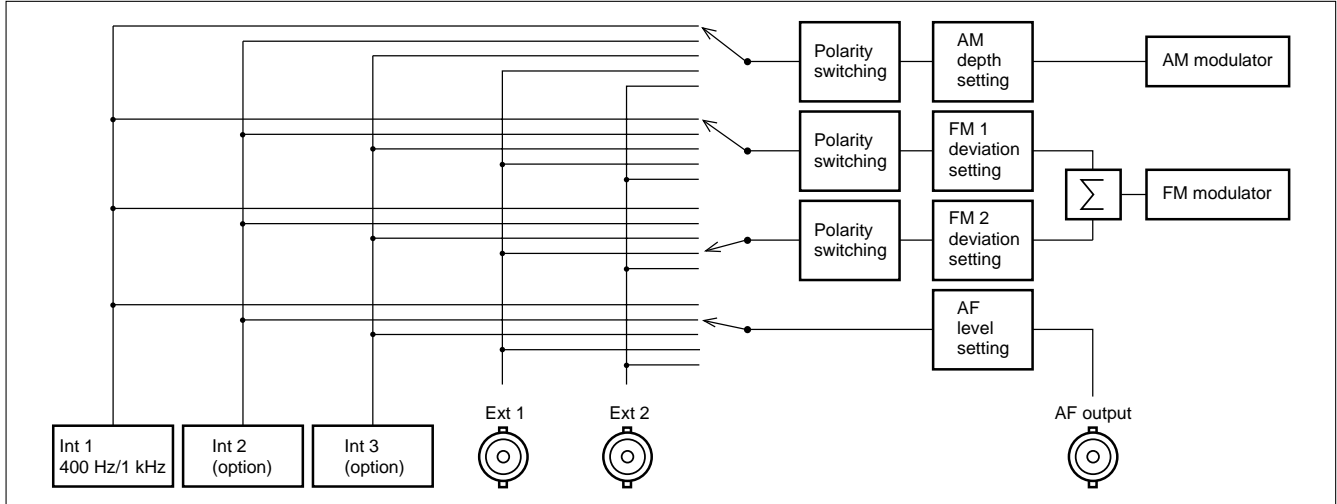

• GPIB Only-Mode linked operation

Two sets of MG3641A/3642A can be linked and operated without an external controller using the Frequency and Output Level Only Modes. The Frequency Only Mode in the frequency offset functions is used for evaluating the characteristics of mixers. The Level Only Mode is useful for evaluating the cross-modulation characteristics of non-linear devices such as amplifiers.

• Pattern generator (Option 23)

Installing the pattern generator (Option 23) in the MG3641A/3642A allows them to generate FSK or pulse modulation combined with FSK encoder (Option 22) or pulse modulator (Option 11) without an external instrument.

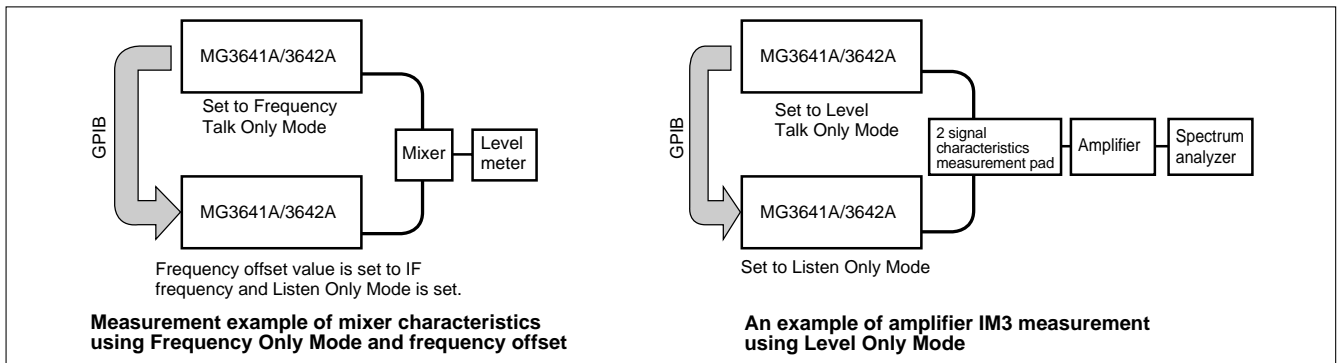

Specifications

• MG3641A/3642A (main frame)

Carrier frequency	Range: 125 kHz to 1040 MHz (MG3641A), 125 kHz to 2080 MHz (MG3642A) Resolution: 0.01 Hz Accuracy: Reference oscillator accuracy; reference oscillator accuracy $\pm(0.3\%$ of FM setting deviation + 5 Hz) at frequency modulation Internal reference oscillator** Frequency: 10 MHz; Aging rate: $\pm 5 \times 10^{-9}$ /day; Start-up characteristics: 1×10^{-7} /10 min (for 24 h after power on), Temperature stability: $\pm 3 \times 10^{-8}$ (0° to 50°C) External reference input: 5/10 MHz, ± 10 ppm, ≥ 0.7 Vp-p/50 Ω (AC coupling), BNC connector (rear panel) Buffer output: 10 MHz, TTL level (DC coupling), BNC connector (rear panel) Switching time: <40 ms (external control, response time from last command until becomes within ± 0.1 ppm of set frequency)
-------------------	--

Continued on next page

Output	<p>Range: -143 to +17 dBm (settable range: -143 to +23 dBm) Units: dBm, dBμ, V, mV, μV (dBμ, V, mV and μV switchable between termination voltage display and open voltage display) Resolution: 0.01 dB Frequency characteristics (at 0 dBm): ±0.5 dB, ±1.0 dB (pulse modulation: on)*² Accuracy: ±1 dB (-127 to +17 dBm, upper limit at pulse modulation*²: +12 dBm), ±3 dB (<-127 dBm) Impedance: 50 Ω (N connector), VSWR: <1.5 (≤-3 dBm), <2.5 (>-3 dBm) Switching time: <50 ms (normal mode), <100 ms (level safety mode), <10 ms (continuous mode) *Response time from last command until becomes within ±0.5 dB of final level</p> <p>Special setting mode Continuous mode: Variable within set value ±10 dB with no interruption of output Safety mode: Prevent large spike signal generation when operating mechanical-type attenuator Interference radiation: <0.1 μV (at output frequency), <1 μV (over entire frequency range, multi-menu display: OFF) *At point 25 mm from cabinet measured with 25 mm diameter loop antenna (2 windings) terminated at 50 Ω</p>																						
Signal purity	<p>Spurious (CW mode, ≤+7 dBm) Harmonics: <-30 dBc (2nd, 3rd) Non-harmonic: <-100 dBc (≥15 kHz offset) Those related power: <-40 dBc (<15 kHz offset) SSB phase noise (CW Mode, 20 kHz offset): <-140 dBc/Hz (10 to <256 MHz), <-136 dBc/Hz (256 to <512 MHz), <-130 dBc/Hz (512 to 1040 MHz), <-124 dBc/Hz (>1040 MHz, MG3642A only) Residual AM: <-80 dBc (≥500 kHz, CW mode, +7 dBm, 50 Hz to 15 kHz demodulation band) Residual FM (CW mode) 300 Hz to 3 kHz demodulation band: <4 Hzrms (10 to <512 MHz), <8 Hzrms (512 to 1040 MHz), <16 Hzrms (>1040 MHz, MG3642A only) 50 Hz to 15 kHz demodulation band: <5 Hzrms (10 to <512 MHz), <10 Hzrms (512 to 1040 MHz), <20 Hzrms (>1040 MHz, MG3642A only)</p>																						
Amplitude modulation	<p>Range: 0% to 100% Resolution: 0.1% Accuracy: ±(5% of set value + 2%) *≥0.4 MHz, ≤+7 dBm, ≤90% AM, source: Int 1 (1 kHz), 300 Hz to 3 kHz demodulation band Modulation frequency response (output: ≤+7 dBm)</p> <table border="1" data-bbox="341 772 1275 989"> <thead> <tr> <th rowspan="2">Carrier frequency</th> <th colspan="2">Upper limit frequency</th> <th rowspan="2">Lower limit frequency</th> </tr> <tr> <th>AM: 30%</th> <th>AM: 90%</th> </tr> </thead> <tbody> <tr> <td>0.4 to <0.5 MHz</td> <td>2 kHz (±1 dB bandwidth)</td> <td>1 kHz (±1 dB bandwidth)</td> <td rowspan="5">DC: External DC coupling (±1 dB bandwidth) 20 Hz: External AC coupling (±1 dB bandwidth)</td> </tr> <tr> <td>0.5 to <2 MHz</td> <td>10 kHz (±1 dB bandwidth)</td> <td>5 kHz (±1 dB bandwidth)</td> </tr> <tr> <td>2 to <32 MHz</td> <td colspan="2">20 kHz (±1 dB bandwidth)</td> </tr> <tr> <td>32 to <64 MHz</td> <td colspan="2">50 kHz (±1 dB bandwidth)</td> </tr> <tr> <td>≥64 MHz</td> <td colspan="2">50 kHz (±1 dB bandwidth), 100 kHz (±3 dB bandwidth)</td> </tr> </tbody> </table> <p>Distortion: <-40 dB (30% AM), <-30 dB (90% AM) *≥0.4 MHz, ≤+7 dBm, source: Int 1 (1 kHz) Incidental FM: <200 Hz peak *≥0.4 MHz, ≤AM: 30%, ≤+7 dBm, source: Int 1 (1 kHz), 300 Hz to 3 kHz demodulation band Modulation signal source: One of internal (Int 1, Int 2, Int 3) and external (Ext 1, Ext 2) Modulation signal polarity: Positive/negative switchable</p>	Carrier frequency	Upper limit frequency		Lower limit frequency	AM: 30%	AM: 90%	0.4 to <0.5 MHz	2 kHz (±1 dB bandwidth)	1 kHz (±1 dB bandwidth)	DC: External DC coupling (±1 dB bandwidth) 20 Hz: External AC coupling (±1 dB bandwidth)	0.5 to <2 MHz	10 kHz (±1 dB bandwidth)	5 kHz (±1 dB bandwidth)	2 to <32 MHz	20 kHz (±1 dB bandwidth)		32 to <64 MHz	50 kHz (±1 dB bandwidth)		≥64 MHz	50 kHz (±1 dB bandwidth), 100 kHz (±3 dB bandwidth)	
Carrier frequency	Upper limit frequency		Lower limit frequency																				
	AM: 30%	AM: 90%																					
0.4 to <0.5 MHz	2 kHz (±1 dB bandwidth)	1 kHz (±1 dB bandwidth)	DC: External DC coupling (±1 dB bandwidth) 20 Hz: External AC coupling (±1 dB bandwidth)																				
0.5 to <2 MHz	10 kHz (±1 dB bandwidth)	5 kHz (±1 dB bandwidth)																					
2 to <32 MHz	20 kHz (±1 dB bandwidth)																						
32 to <64 MHz	50 kHz (±1 dB bandwidth)																						
≥64 MHz	50 kHz (±1 dB bandwidth), 100 kHz (±3 dB bandwidth)																						
Frequency modulation	<p>Range: 0 to 125 Hz (125 to <250 kHz) 0 to 25.6 kHz (16 to <32 MHz) 0 to 250 Hz (250 to <500 kHz) 0 to 51.2 kHz (32 to <64 MHz) 0 to 500 Hz (0.5 to <1 MHz) 0 to 102 kHz (64 to <128 MHz) 0 to 1 kHz (1 to <2 MHz) 0 to 256 kHz (128 to <256 MHz) 0 to 2 kHz (2 to <4 MHz) 0 to 512 kHz (256 to <512 MHz) 0 to 4 kHz (4 to <8 MHz) 0 to 1024 kHz (512 to 1040 MHz) 0 to 10 kHz (8 to <16 MHz) 0 to 2048 kHz (>1040 MHz, MG3642A only)</p> <p>Resolution: 1 Hz (0 to 4 kHz deviation) 250 Hz (102.25 to 256 kHz deviation) 10 Hz (4.01 to 10 kHz deviation) 500 Hz (256.5 to 512 kHz deviation) 25 Hz (10.025 to 25.6 kHz deviation) 1 kHz (513 to 1024 kHz deviation) 50 Hz (25.65 to 51.2 kHz deviation) 1 kHz (1025 to 2048 kHz deviation, MG3642A only) 100 Hz (51.3 to 102 kHz deviation)</p> <p>Accuracy: ± (5% of set value + 10 Hz) (0.4 to <512 MHz), ± (5% of set value + 20 Hz) (512 to 1040 MHz) ± (5% of set value + 40 Hz) (>1040 MHz, MG3642A only) *Source: Int 1 (1 kHz), 300 Hz to 3 kHz demodulation band</p> <p>Modulation frequency response: DC or 20 Hz^{±3} to 20 kHz (0.4 to <10 MHz), DC or 20 Hz^{±3} to 100 kHz (≥10 MHz) *±1 dB bandwidth Distortion: <-40 dB *≥16 MHz, 3.5 kHz deviation, source: Int 1 (1 kHz) <-45 dB *≥16 MHz, 22.5 kHz deviation, source: Int 1 (1 kHz) Incidental FM: <1% peak *≥64 MHz, ≤+7 dBm, 100 kHz deviation, source: Int 1 (1 kHz), 300 Hz to 3 kHz demodulation band External modulation group delay: <30 μs *≥10 MHz, source: external DC coupling mode, modulation rate: ≤100 kHz Modulation signal source (FM1, FM2): One of internal (Int 1, Int 2, Int 3), and external (Ext 1, Ext 2) Modulation signal polarity: FM1, FM2 positive/negative switchable</p>																						
Pulse modulation	According to option specifications																						
Modulation signal source	<p>Internal modulation (Int 1) Frequency: 400 Hz, 1 kHz Accuracy: Same as reference oscillator accuracy Internal modulation (Int 2, Int 3): According to option specifications External modulation (Ext 1, Ext 2) Proper input level: 2 Vp-p approx. Input impedance: 600 Ω, BNC connector Coupling: DC/AC switchable</p>																						
AF output	<p>Output signal source: One of internal (Int 1, Int 2, Int 3), and external (Ext 1, Ext 2) Output level: 0 to 4 Vp-p Output level resolution: 1 mVp-p Output level accuracy: ± (5% of setting level + 2 mVp-p) *Source: Int 1 (1 kHz) Impedance: 600 Ω, BNC connector</p>																						

Continued on next page

Simultaneous modulation	Excluding amplitude modulation and pulse modulation*2 combination, simultaneous modulation, modulation rate, deviation independently settable
Sweep function	<p>Sweep parameters: Frequency, output level, memory</p> <p>Sweep patterns</p> <p>Frequency sweep (start/stop): Linear (specified step size and number of points), Log (multiplying factor: 1%)</p> <p>Frequency sweep (center/span): Linear (specified step size and number of points)</p> <p>Level sweep (start/stop, center/span): dB (specified step size and number of points) *Sweep: continuous mode (max. 20 dB width)</p> <p>Memory sweep: Start/stop</p> <p>Sweep mode: Auto, single, manual</p> <p>Sweep time</p> <p>Setting range: 1 ms to 600 s/point *Actual sweep time depends on sweep parameter (frequency, output level)</p> <p>Resolution: 10 μs/point</p> <p>Auxiliary output</p> <p>X-Out: Ramp waveform (sweep start point: 0 V, sweep end point: +10 V), BNC connector (rear panel)</p> <p>Z-Out: TTL level (H-level at sweeping), BNC connector (rear panel)</p> <p>Blanking-Out: TTL level (L-level at switching), BNC connector (rear panel)</p> <p>Marker-Out: TTL level (H-level at marker match), BNC connector (rear panel)</p>
Functions	<p>Relative display: Carrier frequency, output level</p> <p>Offset display: Carrier frequency, output level</p> <p>Memory: Saves/recalls 1000 panel settings; recall contents: panel, frequency, frequency/output level selection</p> <p>Trigger: An external trigger signal (rear panel BNC connector, TTL level) can be used to execute a previously programmed operation sequence (except power switch, preset key, local key and rotary knob operations). Max. number of sequence steps of trigger program: 20 steps</p> <p>Back-up: The panel settings before power-off are back-upped and displayed again at power-on, except data-input contents, GPIB data contents, remote settings, RPP operations</p> <p>GPIB control: All functions, except power switch, local key, rotary knobs, and resolution keys (Interface: SH1, AH1, T5, L3, TE0, SR1, RL1, PP0, DC1, DT1, C0, E2)</p>
Reverse power protection	Max. reverse input power: ≤50 W (≤1040 MHz), ≤25 W (>1040 MHz, MG3642A only), ±50 Vdc
Power supply	*4 Vac (+10%, -15%), 47.5 to 63/380 to 420 Hz, ≤200 VA
Temperature	Operating: 0° to +50°C, Storage: -30° to +71°C
Dimensions and mass	320 (W) x 177 (H) x 451 (D) mm, ≤20 kg
EMC	<p>EN61326: 1997/A1, 1998 (Class A)</p> <p>EN61000-3-2: 1995/A2, 1998 (Class A)</p> <p>EN61326: 1997/A1, 1998 (Annex A)</p>
LVD	EN610101-1: 1993/A2, 1995 (Installation Category II, Pollution degree 2)

*1: Can be changed to 5 x 10⁻¹⁰/day using reference crystal oscillator (Option 01)

*2: Only with pulse modulator (Option 11) installed

*3: External DC coupling: DC, External AC coupling: 20 Hz

*4: Specify a nominal voltage of either 100 V and 240 V when ordering; the maximum operating voltage is 250 V.

• Options

Option 01: Reference oscillator	<p>Frequency: 10 MHz</p> <p>Aging rate: 5 x 10⁻¹⁰/day</p> <p>Temperature stability: ±5 x 10⁻⁹ (0° to 50°C)</p>
Option 11: Pulse modulator	<p>Frequency: 125 kHz to 2080 MHz</p> <p>On/off ratio: >80 dB</p> <p>Rise/fall time: <100 ns</p> <p>Min. pulse width: <500 ns</p> <p>Pulse repetition rate: DC to 1 MHz</p> <p>Max. delay time: <100 ns</p> <p>Overshoot, ringing: <20%</p> <p>Video feed-through: <20%</p> <p>Pulse modulation input: 50/600 Ω, TTL (positive logic), BNC connector (rear panel)</p>
Option 21: AF synthesizer	<p>Frequency: 0.01 Hz to 400 kHz (sine-wave), 0.01 Hz to 50 kHz (triangular, square and sawtooth waveforms)</p> <p>Resolution: 0.01 Hz</p> <p>Waveform: Sine-wave, triangular, square and sawtooth waveforms</p> <p>Frequency accuracy: Same as reference oscillator accuracy</p>
Option 22: FSK encoder	<p>Frequency shift</p> <p>(Data 2¹, Data 2⁰) = (0, 0): -frequency deviation setting, (Data 2¹, Data 2⁰) = (0, 1): -frequency deviation setting/3, (Data 2¹, Data 2⁰) = (1, 0): +frequency deviation setting, (Data 2¹, Data 2⁰) = (1, 1): +frequency deviation setting/3</p> <p>Frequency set</p> <p>Free: Frequency shift simultaneously with data input</p> <p>Rise trigger: Frequency shift at external clock rise time</p> <p>Fall trigger: Frequency shift at external clock fall time</p> <p>Baseband filter</p> <p>Filter type: 10-th order Bessel filter</p> <p>Cut-off frequency: 100 Hz to 30 kHz (-3 dB)</p> <p>Setting resolution: Upper 2 digits</p> <p>Frequency deviation accuracy: Depends on frequency modulation accuracy of main frame (at by-pass to baseband filter)</p> <p>External modulation input</p> <p>Data 2⁰/2¹: TTL level (pull-down), BNC connector (rear panel)</p> <p>External clock input: TTL level (pull-up), BNC connector (rear panel)</p>

Continued on next page

Option 23: Pattern generator	Data pattern	Free	Number of memories: 4 (defined: 1 to 4) Memory capacity: 524,288 bits/memory Pattern output Range: Top address and data bit length can be set for the respective free-pattern memories. Top address setting range: 00000 to 65,535 Data bit length setting range: 2 to 524,288 bits (Final address of output: 65,535 or less) Memory: Saves 1-byte units via GPIB interface Saves when pattern generator output off, or idle pattern being output
		Fixed	PN9 pseudorandom pattern (conforming to ITU-T V.52), PN15 pseudorandom pattern (conforming to ITU-T O.151), 01 fixed pattern
	Idle pattern	Number of memories: 1 (idle) Memory capacity: 524,288 bits Pattern output Range: The top address and data bit length can be set. Top address setting range: 00000 to 65,535 Data bit length setting range: 2 to 524,288 bits (final address of output: 65,535 or less.) Memory: Saves 1-byte units via GPIB interface Saves when pattern generator output off	
	Output method	Single: Specified data pattern output once only (PN9 and PN15 are output twice.) Continuous: Specified data pattern output continuously When the data pattern is not output, the idle pattern is output continuously.	
	Output rate	Range: 1 to 99,999 bps (resolution: 1 bps) Accuracy: Same as reference oscillator of MG3641A/3642A	
	Output system	1-bit NRZ output (corresponding to binary data output): Data is output to the Data 2 ¹ Output sequentially, one bit after another starting from the top bit. The logic of Data 2 ⁰ is fixed to 0. 2-bit NRZ output (corresponding to quadrature data output): Data is output to the Data 2 ¹ Output and Data 2 ⁰ Output sequentially, two bits after another, starting from the top bit.	
	Output level	Data 2 ⁰ Output: TTL level Data 2 ¹ Output: TTL level Clock Output: TTL level, rising	

• **MX364001B Software for Pattern Generator Data Write**

Read-out data format	DOS text file
Write memory	Data pattern memory (defined: 1 to 4), idle pattern memory (idle)
Contents of write data	Pattern data: 2 to 524,288 bits/memory (text format file) Top address of output: 0 to 65,535 (any settable) Data bit length: 2 to 524,288 bits (Bit length of pattern data automatically calculated and written) Data name: Maximum eight characters (idle pattern memory cannot be named.)
PC	IBM PC/AT compatible
Supporting OS	Microsoft® Windows 95®
Interface	GPIB (National Instruments PCI-GPIB or PCMCIA-GPIB)

Ordering information

Please specify model/order number, name, and quantity when ordering.

Model/Order No.	Name
MG3641A	Main frame Synthesized Signal Generator
MG3642A	Synthesized Signal Generator
	Standard accessories
	Power cord, 2.5 m: 1 pc
B0325	GPIB connector shielded cap: 1 pc
F0013	Fuse, 5 A (for 100 Vac mains): 2 pcs
F0012	Fuse, 3.15 A (for 200 Vac mains): 2 pcs
W1137AE	MG3641A/3642A operation manual: 1 copy
W1137BE	MG3641A/3642A service manual: 1 copy
	Options
MG364[JA-01	Reference oscillator (aging rate: 5 x 10 ⁻¹⁰ /day)
MG364[JA-11	Pulse modulator (pulse repetition rate: DC to 1 MHz)
MG364[JA-21	AF synthesizer (0.01 Hz to 400 kHz, resolution: 0.01 Hz)
MG364[JA-22	FSK encoder (2 or 4 levels FSK)
MG364[JA-23	Pattern generator
	Application software
MX364001B*1	Software for Pattern Generator Data Write (Microsoft® Windows 95)

Model/Order No.	Name
	Optional accessories
J0576B	Coaxial cord (N-P · 5D-2W · N-P), 1 m
J0127A	Coaxial cord (BNC-P · RG58A/U · BNC-P), 1 m
J0007	GPIB cable, 1 m
J0008	GPIB cable, 2 m
MA1612A	Four-Point Junction Pad
MP721[]	Attenuator (DC to 12.4 GHz)
B0395C	Rack mount kit (EIA/IEC)
B0329G	Front cover (3/4MW 4U)
B0412A	Carrying case (with casters and B0329G front cover)
B0330B	Tilt bail (3/4MW 450D)

*1: The following items are required to use the MX364001B, and must be provided by the user.

IBM PC/AT® Personal computer	486DX4 (75 MHz or higher), with RAM of 32 MB or more (recommended) on which Windows 95® is installed 3.5 inch FD drive (for program installation)
GPIB interface	PCMCIA-GPIB or PCI-GPIB or equivalent GPIB interface manufactured by National Instruments Inc., supporting NI-488.2®

Microsoft Windows 95 is a registered trademark of Microsoft Corporation in the USA and other countries.

IBM AT is a registered trademark of International Business Machines.
NI-488.2 is a registered trademark of National Instruments Inc.

SYNTHESIZED SIGNAL GENERATOR
MG3633A
 10 kHz to 2700 MHz

For Evaluating of Quasi-Microwaves and Measuring High-Performance Receivers

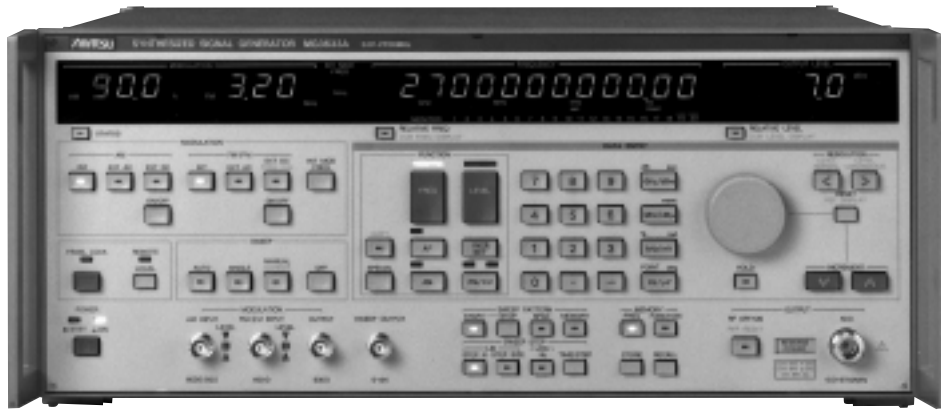

The MG3633A has excellent frequency resolution, frequency switching speed, signal purity, and a high output level, in addition to amplitude, frequency, and phase modulation functions. Also, sweep functions are provided for carrier frequency, output level, and modulation frequency so an appropriate sweep can be performed for various devices to be measured.

Also, the MG3633A has a frequency memory that can store 1000 carrier frequencies and a function memory that stores 100 panel settings. Moreover, since the maximum output level is +17 dBm, it can be used for various local signal sources.

The MG3633A is suitable for research and development of mobile communications in the quasi-microwave band, performance evaluation, characteristics testing, and adjustment of various types of radio equipment such as digital land-based mobile communications, mobile satellite communications, satellite broadcasting, and radio LANs.

Features

• **Low noise**

By using both the latest synthesizer and RF-device technologies and optical data links in the internal control circuit, the SSB phase noise has been cut to -140 dBc/Hz (CW, 1.1 GHz, offset 20 kHz). In particular, the MG3633A shows its power in measurement of narrow-band radio equipment S/N ratio and adjacent channel selectivity.

• **High accuracy and high-output level**

Low levels of -123 dBm can be set with ± 1 dB accuracy by using a high-accuracy programmable attenuator. The output level can be displayed in units of dBm, dB μ V, V, mV, and μ V or as a relative value (dB).

• **Modulation characteristics**

The MG3633A has AM, FM, ϕ M, and a combination of all three modulation functions. A DC mode is provided for FM, which makes simulation of digital transmissions for a pager possible. Also, a built-in AF oscillator with a 0.1 Hz to 100 kHz synthesizer can handle various modulations.

• **Quasi-microwave output**

The MG3633A covers a wide range (from 10 kHz to 2700 MHz) and is suitable for research and development, as well as production of quasi-microwave band radio equipment.

Performance

• **Signal purity**

The MG3633A has excellent spectral purity. As shown in the Fig. 1, the SSB phase noise at 1 GHz with 20 kHz signal offset is -140 dBc/Hz. In particular, this shows its power for generating signals used for testing radio receiver selectivity, for generating high-speed clocks of A/D converters and dividers, as well as for generating standard signals for communications links. Also, since the residual FM is 0.8 Hz rms or less (1.28 GHz or less), even the S/N ratio of narrow-band mobile radio equipment can be measured with sufficient margin (Fig. 2)

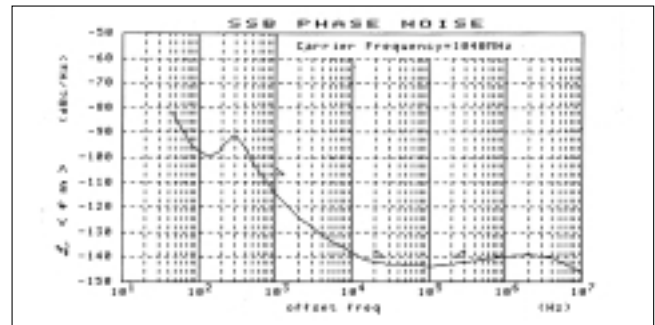

Fig. 1 SSB phase noise

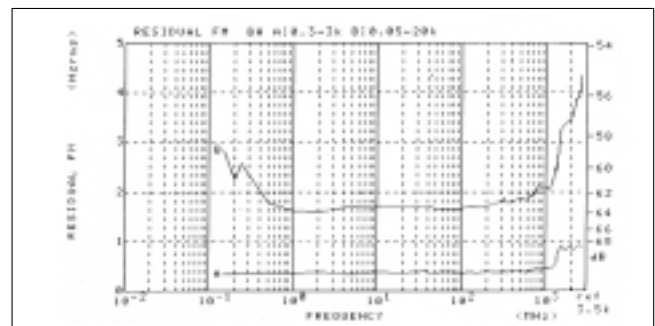

Fig. 2 Residual FM

• Output level characteristics

A maximum output of +17 dBm can be obtained over a wide frequency range so 2-signal or 3-signal testing can be done easily. A high-accuracy highly-reliable programmable attenuator (life cycle over 3 million times) is used and, since flat output characteristics are obtained by internal calibration over a wide range from 10 kHz to 2.7 GHz, it is effective for testing antennas and cables (Fig. 3).

Moreover, compensation data for obtaining flat levels at cable ends can be input by using a power meter, GPIB, controller, and frequency-response compensation software (option).

• Continuously variable output level

The MG3633A can output continuously-variable signals in a 20 dB range with 0.1 dB steps at any level. This is especially convenient for measuring the dynamic range of magnetic tape and squelch sensitivity of radios which produce hysteresis phenomenon as a result of level variation.

• AM

A high-accuracy AM wave is generated over a wide frequency range (Fig. 4). Countermeasures against carrier-wave variation due to vibration permit even SSB radio equipment to be tested with confidence.

• FM

FM with a maximum frequency deviation of 3.2 MHz is possible (1.28 to 2.7 GHz). Also if the frequency deviation is too low, automatic operation is carried out in the stabilized DC-FM mode so even digital data transmission equipment such as papers can be tested (Fig. 5).

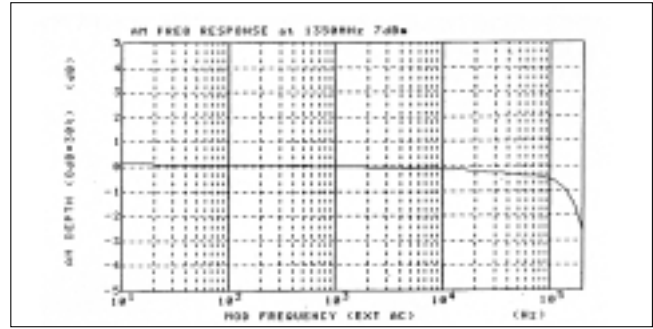

Fig. 4 AM modulation frequency characteristics

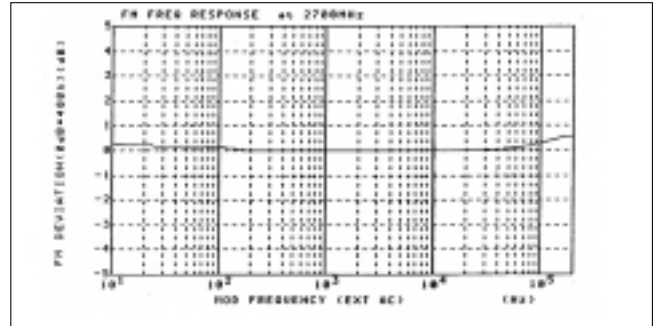

Fig. 5 FM modulation frequency characteristics

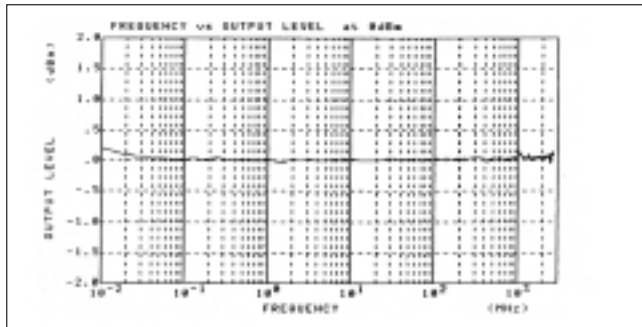

Fig. 3 Output level frequency response

Specifications

Carrier frequency	Range	10 kHz to 2700 MHz			
	Resolution	0.01 Hz			
	Accuracy	Same as that of the reference oscillator			
	Internal reference oscillator*1	Frequency: 10 MHz Start-up characteristics: After 30 minutes of operation: $\leq 1 \times 10^{-7}$ /day, after 60 minutes of operation: $\leq 5 \times 10^{-8}$ /day, Aging rate: After 24 hours of operation: $\leq 2 \times 10^{-8}$ /day, Temperature characteristics: $\pm 5 \times 10^{-8}$ (0° to 50°C)			
	External reference signal input	10 MHz, TTL Level, BNC connector on rear panel			
	Reference signal output	10 MHz, TTL Level, BNC connector on rear panel			
	Switching time	≤ 10 ms (time from last command until frequency has stabilized to within ± 500 Hz of set frequency, during remote operation)			
Output	Range	-143 to +23 dBm			
	Units	dBm, dB μ V, V, mV, μ V (Terminated and open voltages are selectable for dB μ V, V, mV or μ V.)			
	Resolution	0.1 dB			
	Frequency response	± 0.5 dB referred to 0 dBm (< 1280 MHz), ± 1 dB referred to 0 dBm (≥ 1280 MHz)			
	Accuracy	Output level	Frequency	10 kHz to < 1280 MHz	≥ 1280 MHz
			+17.1 to +23 dBm	-	-
			+15.1 to +17 dBm	± 1 dB	-
			-122.9 to +15 dBm	± 1 dB	± 2 dB
			-132.9 to -123 dBm	± 3 dB	± 4 dB
	-143 to -133 dBm	-	-		
Impedance	50 Ω , N-type connector VSWR: ≤ 1.5 (< 1280 MHz, ≤ -3 dBm), ≤ 1.8 (≥ 1280 MHz, ≤ -3 dBm)				
Switching time	Time from last command until output level is stabilized, during remote operation: ≤ 25 ms (at LEVEL NORMAL mode) ≤ 80 ms (when setting level is crossing over -59 dBm, at LEVEL NORMAL mode) ≤ 5 ms (at LEVEL CONTINUOUS mode)				
Interference radiation	≤ 1 μ V (Value is voltage terminated with 50 Ω load, measured 25 mm from front panel with a two-turn 25 mm diameter loop antenna.) Except sweep mode				

Continued on next page

Signal purity	Spurious	At +7 dBm, CW mode: (fc: carrier frequency) Harmonics (2nd, 3rd): ≤ -30 dBc (at ≥ 100 kHz) Sub-harmonics ($f_c/2, 3f_c/2, 5f_c/2$): None (at < 1280 MHz), ≤ -30 dBc (at ≥ 1280 MHz) Non-harmonics: ≤ -80 dBc ($f_c < 640$ MHz, ≥ 10 kHz offset) ≤ -74 dBc (640 MHz $\leq f_c < 1280$ MHz, ≥ 10 kHz offset) ≤ -68 dBc ($f_c \geq 1280$ MHz, ≥ 10 kHz offset)				
	SSB phase noise	At +7 dBm, CW mode, 0° to 35° C				
		Offset frequency	1 kHz	20 to 300 kHz		
		0.01 to <40 MHz	-116 dBc/Hz	-140 dBc/Hz		
		40 to <300 MHz	-119 dBc/Hz	-145 dBc/Hz		
		300 to <600 MHz	-113 dBc/Hz	-143 dBc/Hz		
		600 to <1100 MHz	-107 dBc/Hz	-140 dBc/Hz		
1.1 to <2.4 GHz		-101 dBc/Hz	-132 dBc/Hz			
2.4 to 2.7 GHz	-97 dBc/Hz	-120 dBc/Hz				
	Floor noise: ≤ 145 dBc/Hz (40 to <1100 MHz)					
Residual AM	$\leq 0.02\%$ rms at ≥ 150 kHz (demodulation band: 300 Hz to 3 kHz)					
Residual FM	≤ 0.8 Hz rms at < 1280 MHz (demodulation band: 300 Hz to 3 kHz) ≤ 4 Hz rms at < 1280 MHz (demodulation band: 50 Hz to 20 kHz)					
Amplitude modulation	Range	0 to 100%				
	Resolution	0.1%				
	Internal modulation frequency	Fixed frequency: 400 Hz, 1 kHz Variable frequency: 0.1 Hz to 50 kHz, 0.1 Hz resolution Frequency accuracy: 100 ppm				
	Accuracy	\pm (5% of indicated value +2%) [at ≥ 250 kHz, $\leq +7$ dBm, 0 to 90% and internal 1 kHz]				
	Frequency response	At $\leq +7$ dBm, ± 1 dB bandwidth				
		Lower modulation frequency limit	20 Hz (EXT AC mode), DC (EXT DC mode)			
		Upper modulation frequency limit	Carrier frequency	Modulation factor	0 to 30%	30.1 to 80%
			0.25 MHz $\leq f_c < 0.5$ MHz		5 kHz	5 kHz
	0.5 MHz $\leq f_c < 80$ MHz			20 kHz	10 kHz	
	80 MHz $\leq f_c$		50 kHz	20 kHz		
External modulation	Input level: Approx. 2 Vp-p, 600 Ω Input Impedance: Nominal 600 Ω					
Depth	$\leq 1\%$ (at ≥ 1 MHz, $\leq +7$ dBm, internal 1 kHz, 30%) $\leq 3\%$ (at ≥ 1 MHz, $\leq +7$ dBm, internal 1 kHz, 80%) $\leq 3\%$ (at 250 kHz $\leq f_c < 1$ MHz, $\leq +7$ dBm, internal 1 kHz, 30%) $\leq 10\%$ (at 250 kHz $\leq f_c < 1$ MHz, $\leq +7$ dBm, internal 1 kHz, 80%)					
Incidental FM	≤ 200 Hz peak (at ≥ 250 kHz, $\leq +7$ dBm, 1 kHz, 30%, demodulation band 0.3 to 3 kHz)					
Frequency modulation	Range	0 to 400 kHz (1 MHz $\leq f_c < 40$ MHz)	0 to 800 kHz (320 MHz $\leq f_c < 640$ MHz)			
		0 to 100 kHz (40 MHz $\leq f_c < 80$ MHz)	0 to 1.6 MHz (640 MHz $\leq f_c < 1280$ MHz)			
	Resolution	0 to 200 kHz (80 MHz $\leq f_c < 160$ MHz)	0 to 3.2 MHz (1280 MHz $\leq f_c$)			
		0 to 400 kHz (160 MHz $\leq f_c < 320$ MHz)				
	Internal modulation frequency	Fixed frequency: 400 Hz, 1 kHz Variable frequency: 0.1 to 100 kHz, 0.1 Hz resolution Frequency accuracy: 100 ppm				
	Accuracy	\pm (5% of indicated value +20 Hz) [internal 1 kHz]				
	Modulation frequency response	± 1 dB bandwidth Frequency range: 20 Hz to 100 kHz (EXT AC mode), DC to 100 kHz (EXT DC mode)				
	External modulation	Input level: Approx. 2 Vp-p/600 Ω Input impedance: Nominal 600 Ω				
	Distortion	$\leq 1\%$ (internal 1 kHz, 3.5 kHz deviation)				
Incidental AM	$\leq 0.4\%$ (internal 1 kHz, 22.5 kHz deviation, demodulation band 0.3 to 3 kHz)					
Carrier frequency accuracy in DC-FM mode	± 500 Hz for 30-minute period after calibration and 2-hour warm-up (at < 1280 MHz, < 10 kHz deviation)					
Phase modulation	Range	0 to 80 rad (1 MHz $\leq f_c < 40$ MHz)	0 to 160 rad (320 MHz $\leq f_c < 640$ MHz)			
		0 to 20 rad (40 MHz $\leq f_c < 80$ MHz)	0 to 320 rad (640 MHz $\leq f_c < 1280$ MHz)			
	Resolution	0 to 40 rad (80 MHz $\leq f_c < 160$ MHz)	0 to 640 rad (1280 MHz $\leq f_c$)			
		0 to 80 rad (160 MHz $\leq f_c < 320$ MHz)				
	Internal modulation frequency	Fixed frequency: 400 Hz, 1 kHz Variable frequency: 0.1 Hz to 5 kHz, 0.1 Hz resolution Frequency accuracy: 100 ppm				
Accuracy	\pm (10% of indicated value +0.05 rad) [internal 1 kHz modulation]					
Modulation frequency response	± 1 dB bandwidth Frequency range: 20 Hz to 5 kHz (EXT AC mode), DC to 5 kHz (EXT DC mode)					

Continued on next page

Phase modulation	External modulation	Input level: Approx. 2 V _{p-p} /600 Ω Input impedance: Nominal 600 Ω					
	Distortion	≤1% (internal 1 kHz, 5 rad modulation)					
Internal modulation signal	Frequency range	400 Hz, 1 kHz (fixed oscillator) 0.1 Hz to 100 kHz (variable oscillator) DC voltage signals equivalent peak values of internal modulating sine wave can be applied as a modulating signal using the SPECIAL FUNCTION.					
	Resolution	0.1 Hz					
	Frequency accuracy	100 ppm					
	Distortion	≤0.03% (fixed, 400 Hz and 1 kHz), ≤0.3% (variable, 20 Hz to 50 kHz)					
Memory function	Frequency memory	1000 carrier frequencies (store/recall)					
	Function memory	100 panel settings (store recall)					
Sweep function	Sweep mode	Carrier frequency, output level, AF frequency					
	Sweep pattern			Carrier frequency	Output level	AF frequency	
		Pattern	Start/stop	√	√ ^{*2}	√	
			Center/span	√	√ ^{*2}	√	
		Step	Entering number of steps	√	—	√	
			Entering step size	√	√ ^{*3}	√	
			LOG 1%	√	—	√	
				Frequency memory	Function memory		
		Pattern	Continuous address	√	√		
			Random address	√	√		
Continuous, random mixed			√	√			
Maximum number of steps		20 ^{*4}	20 ^{*4}				
Sweep time	0.1 ms to 600 s, 0.01 ms resolution (minimum time depends on the switching time of each function.)						
Marker	One movable marker						
Sweep signal output	Staircase (saw-tooth waveform), Start point: 0 V, Stop point: 10 V						
Other functions	Modulation signal output	Modulation signal is output when modulating. Output level: Approx. 2 V _{p-p} /600 Ω					
	Simultaneous modulation	Simultaneous modulation is possible in combinations shown below.					
			INT AM	EXT AM	INT FM	EXT FM	INT ∅M
		EXT ∅M	√	√	—	—	√ ^{*6}
		INT ∅M	√ ^{*5}	√	—	—	
		EXT FM	√	√	√ ^{*6}		
		INT FM	√ ^{*5}	√			
	EXT AM	√					
Relative value display	Carrier frequency, output level						
Continuously variable output level mode	Continuously variable within a ±10 dB range of the set level Step size: 0.1 dB						
Trigger function	Previously programmed operation procedure can be started by a trigger input through its input terminal (on rear panel, BNC connector, TTL level). Maximum program steps for triggered operation: 99 steps						
Memory backup	Last settings are stored when power is turned off.						
GPIB	Interface function: SH1, AH1, T5, L3, TE0, LE0, SR1, RL1, PP0, DC1, DT1, C0						
Reverse power	Maximum reverse input power: 50 W (<1000 MHz), 25 W (≥1000 MHz), ±DC 50 V						
Operating temperature	0° to 50°C						
Power	*7Vac ⁺¹⁰ ₋₁₅ %, 48 to 63 Hz, ≤270 VA						
Dimensions and mass	426 (W) x 177 (H) x 451 (D) mm, ≤32 kg						
EMC	EN61326: 1997/A1, 1998 (Class A) EN61000-3-2: 1995/A2, 1998 (Class A) EN61326: 1997/A1, 1998 (Annex A)						
LVD	EN610101-1: 1993/A2, 1995 (Installation Category II, Pollution degree 2)						

*1: Aging rates up to 5 x 10⁻¹⁰/day are available as option.

*2: Step width: Max. 20 dB

*3: 0.1 dB step size only

*4: One continuous address setting is counted as 3 steps.

*5: Same one internal modulation frequency is used.

*6: Different deviation settings are possible for INT and EXT modulations (using the SPECIAL FUNCTION).

*7: Specify one nominal line voltage between 100 and 240 V when ordering. However maximum operational voltage is limited to 250 V.

Options

	Reference oscillators	Standard model	Option 01	Option 02	Option 03
Start-up characteristics	After 30 minutes operation	1 x 10 ⁻⁷ /day	7 x 10 ⁻⁸ /day	–	–
	After 60 minutes operation	5 x 10 ⁻⁸ /day	3 x 10 ⁻⁸ /day	2 x 10 ⁻⁸ /day	–
Aging rate	After 24 hours operation	2 x 10 ⁻⁸ /day	5 x 10 ⁻⁹ /day	2 x 10 ⁻⁹ /day	–
	After 48 hours operation	–	–	–	5 x 10 ⁻¹⁰ /day
Temperature characteristics (0° to 50°C)		±5 x 10 ⁻⁸	±5 x 10 ⁻⁸	±1.5 x 10 ⁻⁸	±5 x 10 ⁻⁹

Option 04: Rear RF output, SMA connector

Peripheral equipment

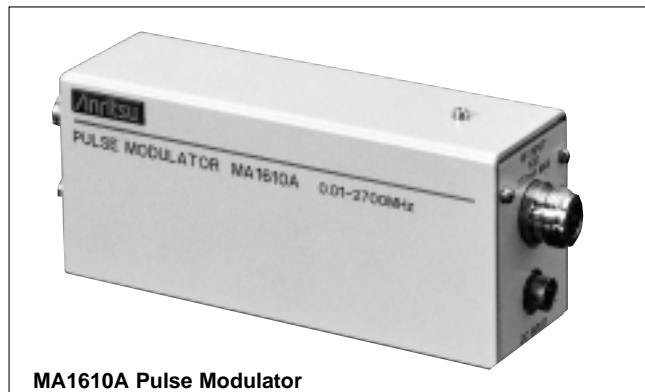

MA1610A Pulse Modulator

The MA1610A is a pulse modulator used in combination with the MG3633A Synthesized Signal Generator to generate high-speed pulse modulated signals. The MA1610A can switch RF signals with a carrier frequency ranging from 10 kHz to 2700 MHz ON and OFF using an input modulation signal (TTL level, 50 Ω terminated). Power is supplied from the MG3633A via its rear panel AUX connector.

Frequency range	10 kHz to 2700 MHz
ON,OFF ratio	≥60 dB (<1000 MHz), ≥40 dB (≥1000 MHz)
Insertion loss	≤2 dB (<1000 MHz), ≤3.5 dB (<1000 MHz)
Rise time	≤15 ns
Fall time	≤5 ns
Minimum pulse width	20 ns
Maximum repetition rate	10 MHz
Maximum delay time	40 ns
Video feed through	≤50 mVp-p
Overshoot/ringing	≤20%
RF input/output	50 Ω, N-type connector, maximum permissible input level: AC 200 mW, DC 3.5 V
Operating temperature	0° to 50°C
Dimensions and mass	131 (W) x 57 (H) x 43 (D) mm, ≤600 g
Standard accessories	J0494: Coaxial cord, 0.3 m (1 pc) J0495: Power cord, 1.0 m (1 pc) W0508AE: MA1610A operation manual (1 copy)

Ordering information

Please specify model/order number, name, and quantity when ordering.

Model/Order No.	Name
MG3633A	Main frame Synthesized Signal Generator
J0025A	Standard accessories Coaxial cord (S-5DWP · 5D-2W · S-5DWP), 1 m: 1 pc
J0127A	Coaxial cord (BNC-P · RG58A/U · BNC-P), 1 m: 1 pc
	Power cord, 2.5 m: 1 pc
F0013	Fuse, 5 A (for 100 Vac mains): 2 pcs
F0012	Fuse, 3.15 A (for 200 Vac mains): 2 pcs
W0504AE	MG3633A operation manual: 1 copy
	Options
MG3633A-01	Reference oscillator
MG3633A-02	Reference oscillator
MG3633A-03	Reference oscillator
MG3633A-04	Rear RF output: SMA connector (however, replaces front-panel RF connector)
MX5126B	Frequency-Response Compensation Software (requires Packet IIe/III/IIIs and ML4803A)
MX5251B	Frequency-Response Compensation Software (requires Packet V series and ML4803A)
	Peripheral
MA1610A	Pulse Modulator (10 kHz to 2.7 GHz)
	Optional accessories
MP614A	Impedance Transformer (50 Ω/75 Ω, 10 MHz to 1.2 GHz)
MA1612A	Four-Port Junction Pad (5 MHz to 3 GHz)
MP659A	Four-Port Junction Pad (40 to 1000 MHz)
Z-164A	T-pad (DC to 1000 MHz)
MB24A	Portable Test Rack

SYNTHESIZER/LEVEL GENERATOR

MG443B

10 Hz to 30 MHz

For Frequency Tracking with ML422C



GPIB

The MG443B is carefully designed. Its output level is highly stable, so it can be used for applications within the telecommunications industry without the need for a separate standard level meter.

Features

- Wide frequency range with 1 Hz resolution
- As many as 20 panel settings can be memorized; memory sweep capability
- High output level characteristics
Flatness: ± 0.07 dB (0° to 50° C)
Level accuracy: ± 0.15 dB (0° to 50° C)
- High precision output level setting of 0.01 dB
- Continuous output level variable within approximately 4.5 dB
- Variety of output impedances
Unbalanced: 50, 75 Ω
Balanced: 75, 135, 150, 600 Ω

SYNTHESIZED LEVEL GENERATOR

MG442A

10 Hz to 20 MHz

Compact and Lightweight



The MG442A is a compactly designed level generator with excellent stability and accuracy in frequency and output level. Because it is a synthesized level generator, its output frequency is highly stable. It has an excellent output level accuracy and a superb frequency response unrivaled by similar level generators.

The MG442A can be used for many applications as a measurement signal source where high frequency stability and level accuracy are required. The MG442A is best suited for use as a signal source for measuring baseband circuits from audio to video and various types of communications systems.

With its ease of operation and excellent portability, it can be utilized for many purposes as a fundamental measuring instrument in laboratories and manufacturing plants.

Features

- Universal output impedance
- Excellent operation: Digital frequency setting with 4 digits and output level with 3 digits
- Compact and lightweight



RADIO COMMUNICATIONS, EMI MEASURING TEST INSTRUMENTS

Selection Guide	432
Measuring Receiver	433
Radio Communication Analyzer	435
Frequency Converter	435
Interference/Field Strength Meters	435, 436
Antennas	436, 437
EMI Measuring Systems	438
EMI Probe	440
EMI Probe Kit	440
Optional Accessories	440

Selection guide

(example of an application; various other types of measurement equipment are also available)

Type of measurement equipment	Anritsu model	Equipment to be measured								
		Mobile equipment			Base station			Service areas	Entrance circuitry	Parts
		Transmitter	Receiver	Maintenance, troubleshooting	Transmitter	Receiver	Construction, maintenance			
Time-domain-capable spectrum analyzer	MS2651B, MS2661B/C, MS2663C, MS2665C, MS2667C, MS2668C	√	√	√	√	√	√	√		√
	MS2683A	√	√	√	√	√	√	√		√
Signal generator	MG3641A		√	√		√	√	√		√
	MG3642A		√	√		√	√	√		√
	MG3633A	√	√	√		√	√			√
	68000C, 69000B	√	√	√		√	√		√	√
Power meter	ML2437A/2438A	√		√	√		√			√
	ML2407A/2408A	√		√	√		√			√
Frequency counter	MF2400B series	√		√	√		√			√
Measuring receiver	ML524B			√			√	√		
Site master	S331B			√			√			√
Network analyzer	54100A series						√			√
	MS4630B	√	√	√	√	√				√
	37200C series	√	√	√	√	√				√
Radio communication analyzer	MS555B	√	√	√	√	√	√			√

EMI measuring instruments selection guide

Models and names		Frequency range or attenuation	Simplified EMI measurement system				
			Noise measures	Conducted interface	Interference power	Radiation noise	All items
Spectrum analyzers	MS2651B, MS2661B/C	9 kHz to 3 GHz	√	√	√	√	√
	MS2663C	9 kHz to 8.1 GHz	√	√	√	√	√
Pre-amplifier	MH648A	100 kHz to 1200 MHz	√		√	√	√
Pulse limiter	ESH3-Z2	9 kHz to 30 MHz		√			√
Absorption clamp	KT-10	30 to 1000 MHz			√		√
	KT-20	30 to 1000 MHz					
Dipole antenna	MP534A	25 to 520 MHz					
Tripod	MB9A	–					
Dipole antenna	MP651A	470 to 1700 MHz					
Tripod	MB9A	–					
Log-periodic antenna	MP666A	200 to 2000 MHz				√	√
Tripod	MB9A	–					
Pole	MB18B	–					
Biconical antenna	BBA9106	30 to 300 MHz				√	√
Line probe	3701	450 kHz to 30 MHz					
EMI probe	MA2601B/C	5 MHz to 1 GHz/1 to 50 MHz	√				√
Fixed attenuator	MP721B	6 dB				√	√
Programmable attenuator	MN63A	0 to 100 dB					
Printer	VP-870	–					
Plotter	MP5300-11	–					
System software	MX264001A (for MS2651B, MS2661B/C, MS2663C)	–		√	√	√	√

MEASURING RECEIVER

ML524B

25 to 1000 MHz

For Measuring Service Area



Custom-made product

**GPIB
OPTION**

The ML524B have a full range of features and functions plus demodulation functions for various signals. Their compact, lightweight construction makes them suitable for a variety of measurement applications. Use of the GPIB interface option allows easy configuration of an automatic test system controlled by a personal computer.

Features

- Very compact and lightweight
- High frequency stability (A synthesizer local is used. Its reference oscillator has a high frequency stability of $\pm 1 \times 10^{-6}$.)
- Wide dynamic range (80 dB without switching)
- Automatic gain calibration

- Direct readout of field strength
- High precision level display (indication in 0.1 dB steps)

Applications

For field strength measurement

- Investigation to determine service areas
- Radio wave propagation test
- Measurement of spurious radiation from transmitter

For other than field strength measurement

- Radio monitoring
- Measuring receiver
- High-sensitivity signal demodulation



Specifications

RF input		Nominal impedance 50 Ω , N-type connector
Frequency	Range	25.0000 to 999.9999 MHz
	Display	Liquid crystal display, 6 digits Minimum digit: 1 kHz (0.5 kHz is displayed using a symbol of ■.)
	Resolution	12.5 kHz (120 kHz bandwidth), 1 kHz (15 kHz bandwidth)
	Setting	Keyboard and FINE dial
	Memory	Up to 100 frequencies can be stored and recalled.
	Reference frequency stability	$\pm 1 \times 10^{-6}$
Voltage measurement (E.M.F.)	Minimum value	5 dB μ V (25 to 300 MHz), 5 dB μ V (300 to 999.999 MHz)
	Maximum value	100 dB μ V (25 to 999.999 MHz)
	Setting	C/N: ≥ 6 dB (at minimum value), Bandwidth: 15 kHz
	Accuracy (digital display)	± 2 dB (\geq minimum value +6 dB)
	Comparison oscillator	Pulse generator
Field strength measurement	Minimum value	-5 to 19 dB μ V/m (25 to 300 MHz), 19 to 32 dB μ V/m (300 to 999.999 MHz)
	Maximum value	0 to 114 dB μ V/m (25 to 300 MHz), 114 to 120 dB μ V/m (300 to 999.999 MHz)
	Setting	C/N: ≥ 6 dB (at minimum value), Bandwidth: 15 kHz
	Type of antenna	Half-wave dipole
Selectivity	6 dB bandwidth	15 ± 2 kHz (15 kHz bandwidth), 120 ± 20 kHz (120 kHz bandwidth)
	Detuning characteristics	15 kHz bandwidth ≥ 50 dB (± 20 kHz off center)
Image ratio		≥ 60 dB (at 25.000 to 299.999 MHz), ≥ 45 dB (at 300 to 999.999 MHz)
Residual spurious		≤ 10 dB μ V (typical near 50, 130, 600, 1000 MHz)
Detection system		Average value

Continued on next page

Measured level indication	Display: Liquid crystal display, 4 digits, Minimum digit 0.1 dB (on digital display), Up to 80 dB (on analog display) Unit: dB μ V, dB μ V/m (on digital display)
Monitor output	AM and FM can be heard from a loudspeaker, and earphone output terminal is also provided.
IF output	Level: ≥ 85 dB μ V at 80 dB μ V input, Impedance: 50 Ω (nominal), Connector: BNC-type
Discriminator output	Level: 1 V $\pm 20\%$ (modulation frequency: 2 kHz, frequency deviation: 3.5 kHz, into 100 kHz load) Impedance: $\leq 150 \Omega$ Connector: BNC-type
Output for recorder	Level: 1 V $\pm 10\%$ (at 80 dB μ V input, into 100 k Ω load), Impedance: $\leq 150 \Omega$, Connector: 3.5 ϕ jack
Ambient temperature	0° to 50°C (operate), -20° to 60°C (storage)
Power	12 Vdc: < 1 A 100 Vac, 50/60 Hz, ≤ 35 VA (using MZ114A AC Power Pack supplied) Ni-Cd battery (optional MZ110B Battery Pack)
Dimensions and mass	210 (W) x 60 (H) x 175 (D) mm, ≤ 4 kg

Power supply selection guide

Type of power supply	Model	When used with ML524B	Remarks
Dry cell	MZ137A Battery Pack 	<ul style="list-style-type: none"> Operates continuously for about 2.5 to 5 hours*1 Sold separately 	<ul style="list-style-type: none"> Twelve alkaline dry cells (LR20) Does not permit GPIB operation
Ni-Cd battery	MZ110B Battery Pack 	<ul style="list-style-type: none"> Operates continuously for about 30 to 60 minutes*1 Sold separately 	<ul style="list-style-type: none"> Six Ni-Cd batteries with the same dimensions as R14 battery, chargeable 200 to 300 times Fits inside the receiver Does not permit GPIB operation
AC supply	MZ114A AC Power Pack 	<ul style="list-style-type: none"> Permits operation at 100/220 Vac One of accessories supplied 	<ul style="list-style-type: none"> DC power is fed to the EXT +12 V terminal of the receiver. Permits GPIB operation EMC, safety
External DC supply	—	<ul style="list-style-type: none"> The receiver can be operated directly from an external 12 Vdc supply. 	<ul style="list-style-type: none"> One DC power cord is supplied. Permits GPIB operation
Battery charger	MZ115B Battery Charger	<ul style="list-style-type: none"> Sold separately 	<ul style="list-style-type: none"> Two MZ110B can be charged simultaneously. EMC, safety

*1: For continuous reception after power on, with calibration performed once only (more calibrations reduce the operating time). Operating is also affected by how the battery has been stored, and operating temperature.

Ordering information

Please specify model/order number, name, and quantity when ordering.

Model/Order No.	Name
ML524B	Main frame Measuring Receiver
J0231	Standard accessories Connecting cord for recorder (3.5 ϕ plug - - · alligator clips), 1.5 m: 1 pc
J0144	DC power cord (RM12BPG-5S · 2CC7 · arrow tips), 1.5 m: 1 pc
A0002	Earphone: 1 pc
MZ114A	AC Power Pack: 1 pc
B0259	Carrying case: 1 pc
W0285AE	ML524A/B/C operation manual: 1 copy
ML524B-01	Options GPIB
ML524B-05	Terminated voltage indication

Model/Order No.	Name
	Optional accessories
MP612A	RF Fuse Holder
MP613A	RF Fuse Element (5 pcs/set)
A0004	Headphone
MZ110B	Battery Pack (with six Ni-Cd batteries)
MZ115B	Battery Charger
MZ114A	AC Power Pack
MP635A	Log-periodic Antenna
MZ137A	Battery Pack
MB19A	Tripod (for MP635A)
J0006	GPIB cable, 0.5 m
J0007	GPIB cable, 1 m
J0008	GPIB cable, 2 m
J0009	GPIB cable, 4 m
MP663A	Dipole Antenna (with pole and tripod)
MP651B	Dipole Antenna
MP18A	Pole (for MP651B)
MB9A	Tripod (for MP651B)
MP520B	CM Directional Coupler (25 to 1000 MHz, 75 Ω , NC-type connector)
MP520D	CM Directional Coupler (100 to 1700 MHz, 50 Ω , N-type connector)

RADIO COMMUNICATION ANALYZER

MS555B

25 to 1000 MHz

For 400/800/900-MHz Narrow Band FM



GPIB

The MS555B is a versatile, compact, and portable test instrument with a frequency range of 25 to 1000 MHz. It includes all the necessary instruments for both transmitter and receiver testing, and can measure such fundamental characteristics as output power, frequency, FM deviation, sensitivity, signal-to-noise ratio, distortion, etc. The MS555B has a host of features that make many discrete instruments obsolete. For example, with its excellent frequency stability and low residual noise, the built-in signal generator is ideally suited to the production and maintenance of narrow-band 400 MHz transceivers and 800/900 MHz band radiotelephone systems. Moreover, thanks to an internal microprocessor, the MS555B can make automatic measurements via the GPIB when connected to an external computer controller. The built-in printer also provides convenient hard copies.

Features

- This instrument includes a power meter, frequency counter, FM deviation meter, AF level meter, SINAD meter, AF oscillator, synthesized signal generator, and DC voltmeter, all in a single cabinet. Additional options include a tone generator, signalling unit for personal radio, and weighting filter*.
- *: ITU-T, C-MESSAGE

FREQUENCY CONVERTER

MH669B

1 to 3 GHz

Expandable to 3 GHz using ML524B



The measurable frequency range can be expanded to 3 GHz by using the MH669B in conjunction with the ML524B Measuring Receiver.

Applications

- Quasi-microwave propagation test
- Investigation to determine service areas

INTERFERENCE/FIELD STRENGTH METER

ML518A, MH650A, MH649A

25 to 1700 MHz

For Measuring Noise Field Strength (in Conformance with CISPR Specifications)



ML518A Interference/Field Strength Meter
MH650A Frequency Converter
MH649A Preselector

The ML518A is a universal multi-purpose field strength meter with many functions and excellent performance in the frequency range from 25 to 1700 MHz. It can be used for investigating the service area of broadcast waves, radio transmission tests, measurement of spurious emissions of transmitters, measurement of antenna characteristics, and for measuring interference waves in conformity with the CISPR specifications.

Features

- A desired frequency can be precisely captured because a tuning frequency can be set up to 1700 MHz with an accuracy of 1 kHz.
- Quick response of the recorder output permits faithful recording of extreme field variations.
- Efficient measurement of interference waves in conformity with the CISPR specifications
- The average value, quasi-peak value, and peak value detection modes allow measurement of radio signals (TV, noise, etc.) which cannot be evaluated by the average value alone.

INTERFERENCE/FIELD STRENGTH METER

ML428B

9 kHz to 30 MHz

For Measuring Noise Field Strength (in Conformance with CISPR Specifications)



GPIB

The ML428B not only enables measurement of the field strength of general broadcasts and radio communications, but it can also perform measurements of interference waves in accordance with CISPR, VDE, FCC, or other specifications. The ML428B possesses a local synthesizer and high-precision sine-wave comparison oscillator to obtain data with excellent repeatability. In addition, the built-in microprocessor allows level calibrations and attenuator operation to be automatically performed to enable direct reading of the field strength and efficient measurement.

Features

- Correct interference measurement can be performed in accordance with CISPR specifications.
- The use of a frequency synthesizer in the local oscillator enables a high degree of frequency stability to be gained.
- Allows direct reading of the field strength.
- Up to a maximum of any 100 frequencies can be stored.
- Prompt measurement is possible through use of the auto-range function.
- Direct readout of field strength is possible arbitrarily for conventional antenna by memorizing its coefficient via GPIB.
- Convenient outdoor operation through the use of a DC power source.

DIPOLE ANTENNA

MP534A/B, MP651A/B, MP663A

25 to 520 MHz

470 to 1700 MHz

300 to 1000 MHz

*Tripod sold separately



MP534A



MP663A

Those half-wavelength dipole antennas are reference antennas, but the element length must be adjusted for each frequency to be measured.

LOG-PERIODIC ANTENNA

MP635A, MP666A

80 to 1000 MHz

200 to 2000 MHz

The gain remains roughly constant over a wide range so the element length does not require adjustment. Compared with dipole antennas, these antennas have a gain of 5 dB.

Specifications

Model	MP635A	MP666A
Frequency range	80 to 1000 MHz	200 to 2000 MHz
Input impedance	50 Ω (connector: N-type)	
VSWR	≤2.5	
Average relative gain	5 dB	
Maximum input power	10 W	
Front-to-back ratio	≥15 dB	
Dimensions and mass	200 x 200 x 1750 mm, ≤7 kg	∅140 x 900 mm, ≤5 kg



LOOP ANTENNA, ROD ANTENNA
MP414B, MP415B

The MP414B/415B can be used with the ML428B Interference Field Strength Meter.

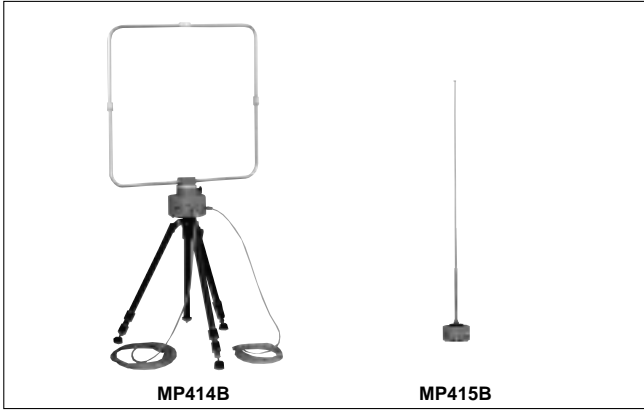

EMI MEASUREMENT SYSTEMS

MS2651B, MS2661B/C, MS2663C SPECTRUM ANALYZER



This is an EMI measurement system which uses MS2651B, MS2661B/C and MS2663C Spectrum Analyzers. An external controller is not required. Install the MX264001A EMI Measurement Software into the PTA function provided with the spectrum analyzer as standard, and then select the initial measurement conditions from the menu to perform the measurement. The measured data can be printed out, and also stored as a bitmap file.

Two measurement modes are available: pre-measurement and auto/manual evaluation measurement. The pre-measurement automatically registers the frequency point that exceeds the limit line (selectable from VDE0871, CISPR Pub, FCC, and USER 1 to 5). If the peak point to be evaluated cannot be detected, auto/manual evaluation measurement is not performed. QP(quasi peak value) or AVERAGE(average value) can be selected from the menu in the measurement mode.

• MX264001A EMI Measurement Software

Setup entry/edit

[Screen 1], the entry/edit mode screen, is displayed when EDIT MODE is selected from the measurement mode select menu. Multiple antenna coefficients and limit lines are registered so that the items can be easily selected from the menu. If an antenna coefficient and a limit line other than those registered on the menu are to be used, they should be entered using the panel keys. Five arbitrary data can be registered for each of the above items in the memory area.

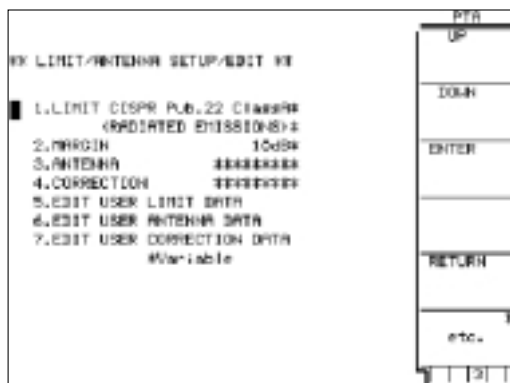

[Screen 1]: Entry/edit screen

Pre-measurement

The menu of [Screen 2] is selected by selecting PRE MEAS(A) from the measurement mode select menu. This allows measurement conditions such as the frequency range of the measurement system, the VBW resolution bandwidth, and the reference level to be set. [Screen 3] is displayed after the measurement is completed.

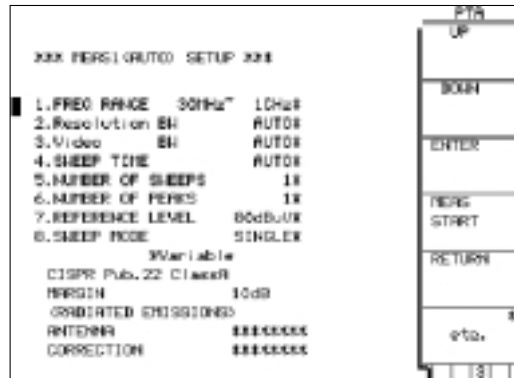

[Screen 2]: Pre-measurement mode setup screen

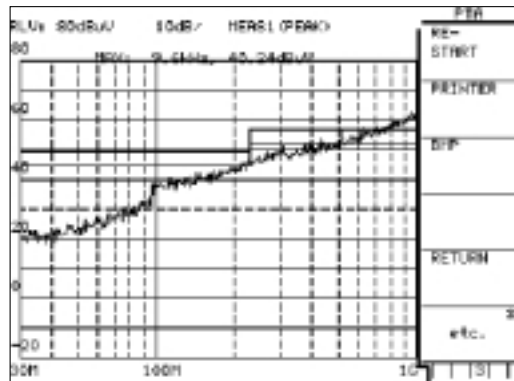

[Screen 3]: Pre-measurement exit screen

Auto evaluation measurement

The setup screen of auto evaluation measurement is displayed when EVA MEAS(A) is selected from the measurement mode select menu. This allows the modification of measurement conditions such as the auto measurement parameters, detection mode, resolution and reference level. After the completion of the measurement of the frequency point to be evaluated, the measurement result is displayed on [Screen 4] as a bar graph.

A ○ (arrow part) or a X mark is displayed at the top of the bar graph when QP detection or AVERAGE measurement is performed, respectively. A detailed measurement is also possible in the manual mode.

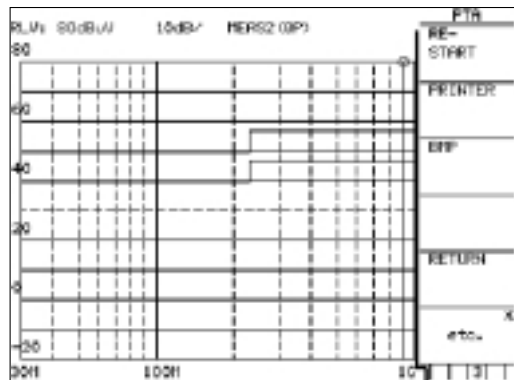

[Screen 4]: Auto evaluation measurement exit screen

• **Measurement system selection**

The following measurement systems can be configured and used to perform the measurements using the MX264001A EMI measurement software.

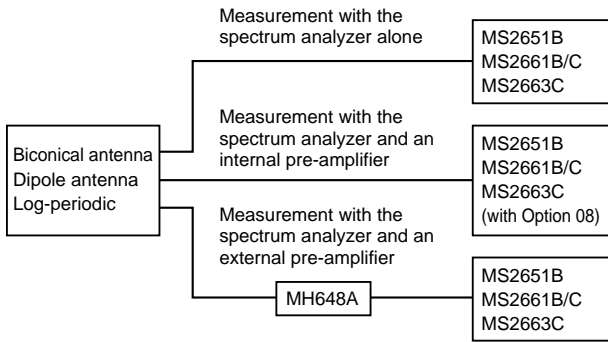

EMI PROBE
MA2601B/C



Custom-made product

The MA2601B/C is a compact loop antenna to use with a spectrum analyzer or a field strength meter for EMI measurement. The combination is used to locate noise sources and to compare relative noise source levels.

Features

- Exact detection of magnetic field components (because MA2601B/C is electrostatically shielded)
- Approximately flat magnetic-field detection characteristics in the range from 100 to 1000 MHz (MA2601B)

Applications

- Sensing magnetic fields when it is connected to a spectrum analyzer, etc.
- Noise immunity testing of electronic components or electrostatic shield-effect testing with using a signal generator

EMI PROBE KIT
MA8611A



In addition to the MA8610A Pre-amplifier that can be directly mounted on the input connector of the MS610C and MS2601B Spectrum Analyzers, this kit also includes MA2601B/C EMI Probes and connecting cables.

Specifications (MA8610A Pre-amplifier)

Frequency range	9 kHz to 2.2 GHz, 50 Ω
Gain	20 dB
Frequency response	±0.5 dB (20 kHz to 1 GHz)
Noise figure	6 dB typ. (≤1 GHz)

OPTIONAL ACCESSORIES

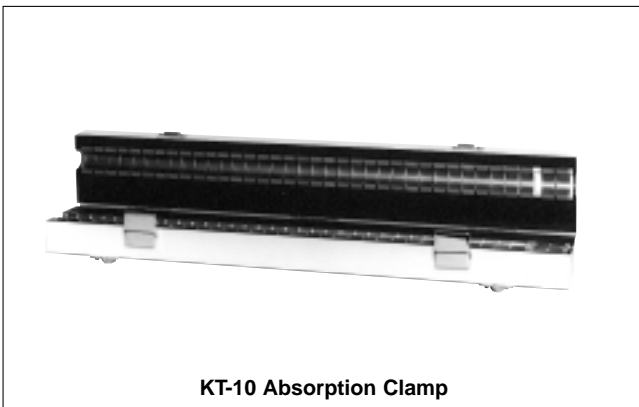

KT-10 Absorption Clamp

This current clamp absorbs interference conducted through the power cable of the device under test.

- Frequency range: 30 to 1000 MHz
- Impedance: 50 Ω
- Applied regulations: CISPR, VDE

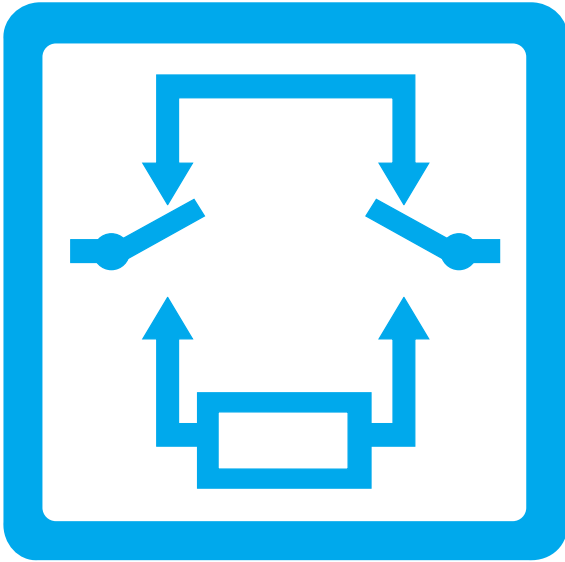

ANALOG TRANSMISSION CHARACTERISTICS MEASURING INSTRUMENTS

Calibration Receiver	442
Level Meter	446
Transmission Measuring Set	446
Selective Level Meter	446
Resistance Attenuator	447

CALIBRATION RECEIVER
ML2530A
 100 kHz to 3 GHz

Measuring Level while Observing Signals under Test



The ML2530A is a receiver for calibrating the output power level of such devices as signal generators and attenuators, covering the range of 100 kHz to 3 GHz. It is suitable for use as a reference level meter for the RF communications bands used by the world's mobile communications markets. High linearity is achieved by using a level detector that uses DSP technology. The level can be measured while observing the signal waveform to be measured by using the spectrum monitor function.

Features

- Wide dynamic range of -140 to +20 dBm and high linearity
- Provides measurement bandwidth of 1 Hz to 100 kHz, so that even signals with large residual FM can be measured using the 1 Hz bandwidth.
- Supports level units



Manual tuning mode

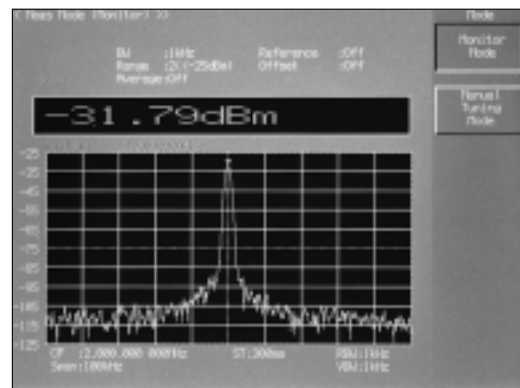

Monitor mode

Specifications

• **ML2530A (main frame)**

General	Frequency range	0.1 to 3000 MHz
	Level range	-140 to +20 dBm
	RF input connector	Connector: N-J Impedance: 50 Ω VSWR: ≤1.25 (Range 1), ≤1.40 (Range 2), ≤1.50 (Range 3) Max. input level: +20 dBm, 0 Vdc
	CAL output*1	Connector: N-J Impedance: 50 Ω Frequency: 50 MHz ±500 kHz Level: 1.000 mW Level accuracy: ±1.2% (RSS: ±0.9%) Harmonic frequency: ≤-50 dBc
	Reference oscillator	Frequency: 10 MHz Start-up characteristics: ≤±5.1 × 10 ⁻⁸ /day (10 minutes after power on, with reference to frequency at 24 hours after power on) Aging rate: ≤±2.1 × 10 ⁻⁸ /day, ≤±10.1 × 10 ⁻⁸ /year (with reference to frequency at 24 hours after power on) Temperature characteristics: ≤±5.1 × 10 ⁻⁸ (with reference to frequency at 25°C in 0° to 50°C temperature range) Accuracy: ≤±15.1 × 10 ⁻⁸ (24 hours after power on, within 6 months of calibration)
	External reference input	Connector: BNC-J Impedance: 50 Ω Frequency: 10 MHz ±10 Hz Level: 0.5 to 5.0 Vp-p
	Internal reference output	Connector: BNC-J Impedance: 50 Ω Frequency: 10 MHz Frequency accuracy: Same as reference oscillator Level: 2.1 V ±0.6 Vp-p (when 2 m coaxial cable terminated with 50 Ω)
Level measurement	Measurement modes	Manual tuning: Measures level of frequency input directly by ten keys and encoder Monitor: Measures level of frequency specified by marker on spectrum monitor
	Measured frequencies	Range: 100 kHz to 3000 MHz, Resolution: 1 Hz
	Measurement bandwidth	Range: 1 Hz to 100 kHz (1-10 sequence) Filter: Gaussian type Accuracy (3 dB width): ±20% (BW: 1 Hz), ±5% (BW: 10 Hz to 100 kHz)
	Measured level	Range: -140 to +20 dBm Resolution: 0.1, 0.01, 0.001 dB
	Range	Range 1: -35 to +20 dBm, Range 2: -80 to -25 dBm, Range 3: -140 to -70 dBm
	Error*2	Total relative error: In-range linearity + range switching error + noise floor error +1 digit error Total absolute error: Total relative error + CAL output level accuracy + mismatch error at CAL + sensor module calibration factor uncertainty + calibration receiver linearity + sensor module insertion loss reproducibility + mismatch error In-range linearity: ±0.05 dB/55 dB (BW: 1/10/100 Hz, RSS: ±0.03 dB/55 dB) ±0.09 dB/55 dB (BW: 1/10 kHz, RSS: ±0.07 dB/55 dB) ±0.22 dB/55 dB (BW: 100 kHz, RSS: ±0.20 dB/55 dB) *In same range, BW: 100 kHz, frequency: ≥1 MHz Range switching error: ±0.01 dB (at range switch point: -30, -75 dBm) Noise floor (BW: at 100 Hz): ≤-70 dBm (Range 1, ≤11 MHz), ≤-80 dBm (Range 1, >11 MHz), ≤-115 dBm (Range 2, ≤11 MHz), ≤-120 dBm (Range 2, >11 MHz), ≤-125 dBm (Range 3, ≤11 MHz), ≤-135 dBm (Range 3, >11 MHz), Noise floor error: ±0.05 dB (S/N: ≤35 dB), ±0.04 dB (S/N: ≤25 dB), not specified (S/N: ≤10 dB) Frequency drift error: ±0.007 dB (1% of BW frequency drift relative to set signal frequency) BW switching error: ±0.01 dB (BW: 1 Hz to 10 kHz), ±0.05 dB (BW: 1 Hz to 100 kHz, frequency: ≥1 MHz) *Excluding effect of measured signal residual FM
	Average	Measurement times: 1 to 256
	Display units	dBm, dB, dBμ, dBμ (emf) W, mW, μW, pW, fW, aW (automatically chosen best unit for measured value) V, mV, μV, nV, pV (automatically chosen best unit for measured value)
	Display digits	dB units: 0.1, 0.01, 0.001 dB W/V units: 3, 4, 5 digits
	Reference	Set any value: -180 to +60 dBm Meas → Ref: Obtain current measured value
	Offset	Setting range: -100 to +100 dB
Calibration	Calibration frequency count: 300 Calibration level: 0 dBm +3/-4 dB (relative level calibration at Range 1, using MA2540A) -30 dBm +3/-4 dB (calibration between Range 1 and Range 2) -75 dBm +3/-4 dB (calibration between Range 2 and Range 3)	
Spectrum monitor	Center frequency	100 kHz to 3000 MHz, Min. setting resolution: 1 Hz
	Frequency span	10 kHz to 1 MHz, Setting resolution: 1 Hz
	Resolution bandwidth	300 Hz to 100 kHz (1-3 sequence)
	Video bandwidth	10 Hz to 100 kHz (1-3 sequence)
	Sweep time	100 ms to 1000 s
	Reference level	Range 1: +20 dBm, Range 2: -25 dBm, Range 3: -70 dBm

Continued on next page

Spectrum monitor	Markers	Functions MKR → PEAK: Moves marker to max. level in monitored range MKR → CNTR: Sets marker frequency to center frequency of monitored range PEAK → CNTR: Sets max. level frequency to center frequency of monitored range Frequency readout level Range 1: ≥-35 dBm, Range 2: ≥-80 dBm, Range 3: ≥-100 dBm Zone marker width: Spot, 1, 5, 10 div.
	Auto-tune	Signal detection frequency range: 30 to 3000 MHz Signal detection level: ≥-30 dBm
Other	Save/recall	Save count: 100
	Panel lock	Function: Disables all key and encoder functions except power switch and panel lock key
	GPIB	Function: Used to control ML2530A as device from controller Interface functions: SH1, AH1, T6, L4, SR1, RL1, PP0, DC1, DT1, C0, E2
	Power	100 to 120 V/200 to 240 V (auto-switching), 47.5 to 63 Hz, ≤120 VA
	Dimensions and mass	426 (W) x 221.5 (H) x 451 (D) mm, ≤17.9 kg
	Environmental conditions	Operating temperature range: 0° to 50°C Storage temperature range: -20° to +60°C
	EMC	EN61326: 1997/A1, 1998 (Class A) EN61000-3-2: 1995/A2, 1998 (Class A) EN61326: 1997/A1, 1998 (Annex A)
LVD	EN610101-1: 1993/A2, 1995 (Installation Category II, Pollution degree 2)	

*1: At constant temperature in operating range of 15° to 35°C

*2: At fixed temperature in ambient temperature range of 15° to 35°C, and level calibration after 1 hour warm-up

MA2540A Sensor Module

Frequency range	100 kHz to 3000 MHz
Level	Level range: -140 to +20 dBm, Max. input level: +20 dBm
RF input connector	Type: N-J Nominal impedance: 50 Ω VSWR (power sensor side): ≤1.30 (100 to 300 kHz), ≤1.20 (0.3 to 1 MHz), ≤1.36 (1 to 3000 MHz) VSWR (through side): ≤1.12 (0.1 to 100 MHz), ≤1.35 (100 to 3000 MHz)
RF output connector	Type: N-J, Nominal impedance: 50 Ω
RF input/output characteristics	Through side insertion loss: ≤0.7 dB Through side insertion loss reproducibility: ±0.006 dB
Dimensions and mass	63 (W) x 54 (H) x 206 (D) mm, ≤1 kg
Environmental conditions	Same as the ML2530A

Sensor module calibration factor uncertainty

Frequency	Simple total	RSS total
0.1 MHz	±3.0%	±1.4%
10 MHz	±2.4%	±1.1%
100 MHz	±2.4%	±1.1%
1000 MHz	±3.0%	±1.4%
2000 MHz	±3.0%	±1.4%
3000 MHz	±3.2%	±1.5%

Total level error

The total level error is the total of each error source. For example, the total relative level error at a frequency of 1 GHz and a BW of 100 Hz is as shown below.

The absolute level error for a measured signal at a frequency of 1 GHz, measurement bandwidth of 100 Hz, device under test VSWR of 1.5, and signal level of -100 dBm is as follows.

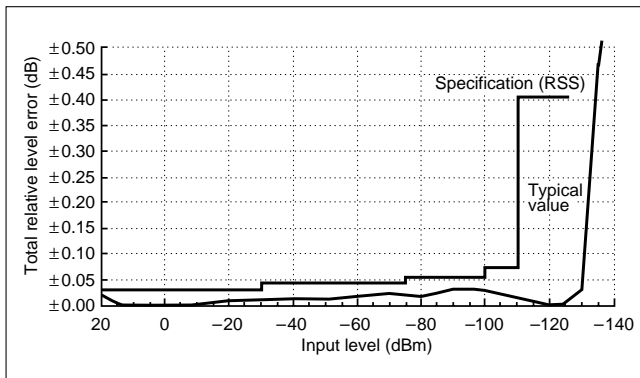

Source of uncertainty	NIST traceable uncertainty
Relative level error at -100 dBm	1.6% (±0.07 dB)
CAL output level error	±0.93%
Mismatch error at calibration	±0.23%
Sensor module calibration factor error at measured frequency	±1.4%
Linearity error of the ML2530A power measurement section	±1.0%
Sensor module relay repeatability	±0.14% (±0.006 dB)
DUT mismatch error sensor module + calibration receiver VSWR: 1.2 (typ.)	±3.7%
Total (RSS)	±4.5 (±0.19 dB)

Ordering information

Please specify model/order number, name, and quantity when ordering.

Model/Order No.	Name
ML2530A	Main frame Calibration Receiver
	Standard accessories
	Power cord, 2.6 m: 1 pc
F0012	Fuse, 3.15 A: 2 pcs
W1492AE	ML2530A operation manual: 1 copy
	Optional accessories
MP721A	Fixed attenuator (3 dB, 2 W)
MP721B	Fixed attenuator (6 dB, 2 W)
MP721C	Fixed attenuator (10 dB, 2 W)
MP721D	Fixed attenuator (20 dB, 2 W)
MP721E	Fixed attenuator (30 dB, 2 W)
MP721F	Fixed attenuator (40 dB, 2 W)
MP721G	Fixed attenuator (50 dB, 2 W)
MP721H	Fixed attenuator (60 dB, 2 W)
J0078	High power fixed attenuator (20 dB, 10 W)
J0063	High power fixed attenuator (30 dB, 10 W)
J0395	High power fixed attenuator (30 dB, 30 W)
J0007	GPIB cable, 1 m
J0008	GPIB cable, 2 m
J0431F	Coaxial cable (BNC-P · RG55A/U · BNC-P), 1 m
J0431G	Coaxial cable (BNC-P · RG55A/U · BNC-P), 2 m
J0903A	Coaxial cable (N-P · RG-142B/U · N-P), 1.5 m
J0904A	Sensor module cable, 1.5 m (for MA2540A control)
B0333D	Rack mount kit
B0329D	Front cover
B0331D	Front handle (2 pcs/set)
B0332	Joint plate (4 pcs/set)
B0334D	Carrying case (hard type, with protective cover and casters)
	Peripheral instruments
MS616B	Modulation Analyzer (150 kHz to 3000 MHz)
MG3633A	Synthesized Signal Generator (10 kHz to 2700 MHz)
MA2540A	Sensor module Sensor Module
	Standard accessories
J0903A	Coaxial cable (N-P · RG-142B/U · N-P), 1.5 m: 1 pc
J0904A	Sensor module cable, 1.5 m (for MA2540A control): 1 pc
W1491AE	MA2540A operation manual: 1 copy

LEVEL METER ML424A, ML424B

10 Hz to 20 MHz 10 Hz to 30 MHz

For Constructing and Maintaining FDM Communication Lines



Custom-made product

The ML424A/B is a compactly designed level-meter of high level-measuring accuracy with a calibration signal internally provided. It is also capable of measuring noise levels in conformity with the ITU-T Recommendations with the necessary psophometer option.

Features

- Excellent frequency response of ± 0.1 dB over the range from 100 Hz to 13 MHz
- High measuring accuracy of ± 0.2 dB including the frequency response, attenuator step accuracy, and temperature stability
- A psophometer option can be incorporated (option 01) for measuring noise levels of telephone and sound program circuits. The characteristics of the weighting filters conform to the ITU-T Recommendations P.53 and J.16.
- The ML424B provides true RMS detection

TRANSMISSION MEASURING SET ME446A/B, ME447A/B/D/E

10 Hz to 20 MHz

For Measuring Base Band and Frequency Band of FDM Communication Lines



Custom-made product

ME447A

The ME446A/B is a compact test set which consists of the MG442A Synthesized Level Generator and the ML424A/B Level Meter. The MG442A has a superior output level accuracy of within ± 0.2 dB including all the frequency characteristics, step accuracy of the attenuator, temperature stability, etc. Output level can be varied in fine steps of 0.1 dB. For this reason, the test set is capable of end-to-end tests of transmission lines by matching the dials of frequency and level without adjustment of the transmitting level.

The ML424A/B is capable of measuring the level of a signal or noise with high accuracy. The frequency range is wide, from 30 Hz to 150 kHz at 600 Ω balanced input impedance, from 4 to 650 kHz at 75 Ω and 150 Ω balanced, and from 10 Hz to 20 MHz at 75 Ω unbalanced, so that apparatus and transmission lines from the voice frequency band to the carrier frequency band up to 3600 channels can be tested. The ME446A/B allows both efficient and economical maintenance of multichannel communication systems.

The ME447A/B is a compact test set composed of the MG442A Synthesized Level Generator, the ML424A/B Level Meter, and the MN415A Level Comparator. This test set can, in addition to the functions possessed by the ME446A Transmission Measuring Set, easily measure gain and loss with high accuracy and digitally display measurement results.

SELECTIVE LEVEL METER ML422C

50 Hz to 30 MHz

For Measuring FDM Communication Lines with High Level Accuracy



Custom-made product

GPIB

The ML422C is designed for use with an ITU-T system. This instrument covers an extremely wide frequency range, from 50 Hz to 30 MHz. This remarkable instrument offers highly accurate measurement of signal levels, and it has the frequency accuracy and stability needed to manufacture and maintain FDM systems, from voice frequencies up to 3600 channels. The ML422C can also function as a wideband level meter, psophometer, or voice band analyzer.

Features

- Highly accurate level measurement
- Measurement of transmission impairment
- 48 kHz group filter
- Intrinsic distortion below -70 dB
- True RMS value detection and 3.1 kHz bandwidth
- Built-in microprocessor for simple operation

RESISTANCE ATTENUATOR
MN510C/D

DC to 500 MHz

These are variable resistance attenuators for measurement of 50 and 75 Ω impedance systems. Each of these attenuators has a wide frequency range and is highly accurate, compact, lightweight with good articulation, and easy to handle. Moreover, comparison measurement can be made far more smoothly when used in conjunction with a key box.



Custom-made product

MN510D

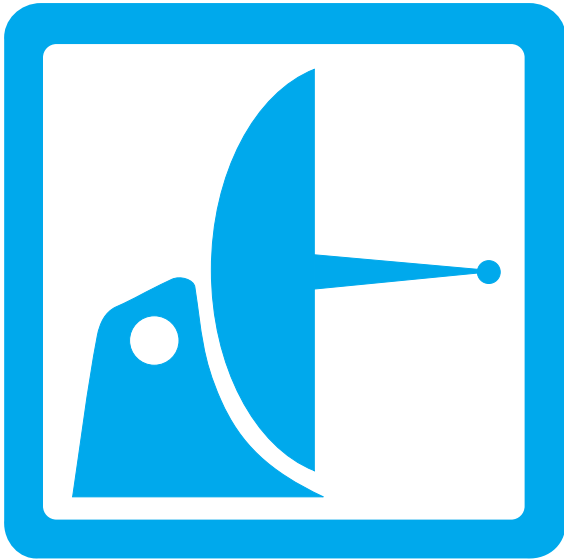

MICROWAVE MEASURING INSTRUMENTS

Radar Test System	450
Microwave Repeater Checker	452
Signal Generator	452
Programmable Attenuators	452

RADAR TEST SYSTEM (RTS)

ME7220A

76 to 77 GHz

*Target Simulation & Signal Analysis for Automotive Radar
Exceptional Performance at an Affordable Price*

NEW



Description

The ME7220A Radar Test System (RTS) accurately and repeatedly characterizes 76-77 GHz automotive radar modules and systems, in a confined and controlled environment, to ensure quality and optimum functionality. The RTS is designed to work with current and future generations of automotive radar, including Adaptive Cruise Control (ACC) radar and collision warning or avoidance radar. The test system provides a simulated radar target response with one of two set target ranges with an adjustable target Radar Cross Section (RCS). The signal response can be Doppler shifted to simulate the speed of a moving target. The system also allows the measurement of the power characteristics or Effective Isotropic Radiated Power (EIRP) of the transmitted radar signal as well as its spectral characteristics (bandwidth, spurious signals, AM/FM Noise, etc.). The ME7220A RTS is the ideal solution for your testing environment, including research and development, radar module manufacturing, or vehicle manufacturing. Whether you are involved in the development of components and systems, setting up for production of sensors, or installing modules on automobiles, you will find that the ME7220A is an essential tool for dramatically reducing your development and test times and for helping you deliver a superior product.

Features

- Verifies operation under realistic conditions by simulating moving targets (other vehicles or roadside objects) at multiple target distances
- Fully characterizes the radar module by quantifying transmitter, receiver and antenna performance
- Integrated functionality allows radar signal power and frequency measurements without external equipment. Interfaces with external test accessories including spectrum analyzers and power meters for complete test flexibility
- Suited for stand-alone, bench-top or anechoic-chamber testing, but easily integrates with other instruments into an automated test bench or into standard production lines for complete testing of the radar modules
- Built-in laser allows accurate alignment of the radar-under-test to the RTS antennas without additional mechanical fixtures
- Speeds automobile production by simplifying functional testing and alignment of the radar sensor (antenna) when installed on the vehicle
- Easily controlled from an external computer (via RS-232) or by using the included handheld manual controller

Specifications

General	Frequency range		76 GHz to 77 GHz	
	Antenna E-field polarization		Horizontal standard (other polarization options available)	
	Alignment laser		Class II laser, 600-700 nm, output power <1 mW (alignment laser shuts off above 40°C)	
Radar signal analysis	Received radar power (at RTS waveguide input)		-10 dBm, specifications below apply	
	Measured radar power	Internal meter	Range	30 dB, minimum
			Accuracy	±2 dB accuracy
		External meter	Range	35 dB, minimum
			Accuracy	±1 dB accuracy, including IF measurement and EIRP Cal Factor
	Maximum radar occupied frequency		Full band 76 to 77 GHz (translated to IF of 4.7 to 5.7 GHz)	
Radar transmit frequency spectrum	External spectrum analyzer		Accuracy of 76-77 GHz frequency limited by spectrum analyzer external reference and specifications. If RTS internal reference is used, accuracy is 50 ppm.	
	Internal frequency measurement		Accuracy of displayed frequency is ±50 MHz, maximum	
Spurious signals, in-band			38 dBc maximum, referenced to output signal	

Continued on next page

Target simulation	Received radar power (at RTS waveguide input)		-15 dBm, specifications below apply	
	Radar occupied bandwidth		300 MHz, maximum, in the 76-77 GHz range	
	Number of simultaneous targets		1 (either near target or far target)	
	Target distance	Near target	3.5 meters nominal (+ distance from RTS to radar)	
		Far target	116.5 meters nominal (+ distance from RTS to radar)	
		Distance accuracy	NEAR Target = ± 0.5 m, maximum FAR Target = ± 2.0 m, maximum	
		Distance from RTS to DUT radar	1.5 meter, minimum	
	Radar cross section (RCS)	Maximum RCS	-4 dBsm, minimum (near target) 50 dBsm, minimum (far target)	
		RCS adjustment range	50 dB, 1 dB steps	
		RCS accuracy	± 0.75 dB $\pm 5\%$ of attenuation, maximum (measured at a single frequency of 76.5GHz)	
			± 2.5 dB, maximum (measured over 76-77 GHz)	
	Target speed simulation (Doppler frequency)	Speed range	0 to ± 250 km/h, minimum (0 to ± 35 kHz, minimum)	
		Speed step size	0.1 km/h, minimum (15 Hz, minimum)	
		Speed error	0.2 km/h, maximum (30 Hz, maximum)	
		Doppler carrier & sideband suppression	40 dBc, minimum	
	Signal Characteristics	Spurious signals (measured at waveguide output)	In-band responses	40 dBc, maximum
			Out of band	Local oscillator signal: -5 dBm, maximum (at 70.8 to 71.8 GHz) Image response: -3 dBc, maximum (65.6 to 66.6 GHz)
		RF noise density (CW)	Local oscillator phase noise	-80 dBc/Hz @ 100 kHz offset, maximum
			AM noise for target simulation	-130 dBm/Hz @ 2 MHz offset, maximum
	Display module	Display screen	160 x 128 dot matrix monochrome LCD, with backlight	
Cable from main module		1 meter		
Power requirements	Primary power	85 - 240 Volts AC 50-60 Hz 200VA, maximum		
Environmental	Operating temperature range	+15°C to +35°C (0°C to +50°C, with reduced performance)		
	Operating humidity	5% to 95% at 40°C		
	Warm-up time	30 minutes, maximum, for ambient +15 to +35°C		
	Storage temperature	-15°C to 75°C		
	EMC & safety	Meets European community requirements for CE marking		
Size and weight	Dimensions	197.6 x 485.6 x 553.6 mm, main module 178.8 x 228 x 76.5 mm, display module		
	Weight	10 kg, main module 1 kg, display module		
Front panel connectors	Antenna input/output	WR12 waveguide, 0 dBm maximum no damage		
Rear panel connectors	Power meter port	N (F), 50 Ω , 10 dBm maximum output		
	Spectrum analyzer port	N (F), 50 Ω , 10 dBm maximum output		
	10 MHz reference input	BNC (F), 50 Ω , +15 dBm to -5 dBm, 25 V DC, max		
	RS-232 serial port	D-Sub 9-pin (M)		
	IF external loop	2 SMA (F), 0 dBm maximum input/output		

Ordering information

Please specify model/order number, name, and quantity when ordering.

Model/Order No.	Name
ME7220A	Radar Test System includes, in addition to the main and display modules, the following accessories: - WR12 Horn Antennas, quantity 2 - Operation and programming manual - N-type, 50 Ω termination - Display interface cable - Serial interface cable - Power cord
1A	Options Rack mount kit with handles
2A	Antenna polarization – vertical
2B	Antenna polarization – 45° slant left
2C	Antenna polarization – 45° slant right

Model/Order No.	Name
MS2663C ML2437A MA2472A	Recommended accessories to increase the measurement capabilities of the ME7220A: Spectrum Analyzer, 9 kHz to 8.1 GHz Power Meter, Single Channel Power Sensor, 10 MHz to 18 GHz
15NN50-1.5C 15NN50-3.0C 15NN50-5.0C	Optional accessories: 50 Ω Cable, N(M)-N(M), 1.5 m, 6 GHz 50 Ω Cable, N(M)-N(M), 3.0 m, 6 GHz 50 Ω Cable, N(M)-N(M), 5.0 m, 6 GHz

MICROWAVE REPEATER CHECKER MS75B

For Maintaining Microwave Repeaters



Custom-made product

The Microwave Repeater Checker (MRC) is an integrated microwave measuring instrument packed in a handy carrying case. It consists of three devices most frequently used for the maintenance of microwave communications systems: a power meter (10 MHz to 14 GHz) and frequency counter (10 Hz to 18 GHz) are standard accessories, and a signal generator is sold separately. The signal generator can be changed according to the frequency band to be measured. There are eight difference generators available for the frequency range 1.7 to 13 GHz.

Features

- Maintains and adjusts microwave line repeaters
- All parts and accessories are contained in the carrying case so the measurement procedure is less time-consuming.
- When removed from the carrying case, the power meter can be mounted independently in a specially designed case (optional accessory). It can run on either batteries or AC line power when used separately.

SIGNAL GENERATOR MG724E1/G1

1.7 to 13 GHz

For Maintaining and Adjusting Microwave Links



Custom-made product

The MG724E1/G1 are a compact lightweight microwave signal generator, designed for medium – and small – capacity microwave line repeater maintenance or adjustment. The instrument is best suited to measure AGC characteristics, squelch function, and signal-to-noise ratio. Its high signal purity and frequency stability also enable it to be used as a general-purpose signal source for microwave receiver adjustment on a production line.

Features

- High signal purity
- High frequency stability
- Wide output level range
- Low price
- Small and lightweight

PROGRAMMABLE ATTENUATOR MN63A, MN65A, MN72A, MN64B

DC to 2 GHz DC to 6 GHz DC to 18 GHz DC to 1 GHz

For Configuring Automated Measurement Systems



MN63A

GPIB

The MN63A/65A/72A/64B provide GPIB as a standard feature and are suitable for automatic measuring system components used in R&D, inspection, or production. The 50 Ω models are available in three different frequency ranges, which can be selected to match the application for maximum economy. The attenuation calibration value is stored in the internal memory and can be uploaded to the system controller for checking against measured values, permitting a significant increase in system accuracy. A relative setting function is also provided, which allows measurement to be referenced to any arbitrary level. Rotary encoders are standard, allowing simple, smooth setting under manual control.

Features

- Wide frequency range
- High accuracy
- Long operating life
- High-speed switching
- Readout of attenuation calibration via GPIB
- Relative attenuation display function
- Rotary encoders for smooth manual setting

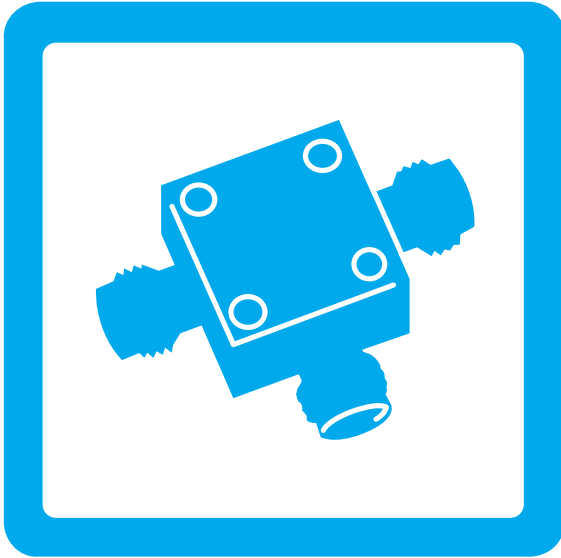

MICROWAVE COMPONENTS

Outline of Microwave Components	454
K Connector®	456
V Connector®	461
Integrated V Connector®	465
Connector Tools	466
RF Cables	467
Coaxial Adapters	470, 472, 473
Waveguide-To-Coaxial Adapters	474, 477
Coaxial Terminations	481, 482
Fixed Attenuators	483
Step Attenuators	485
SWR Bridges	487
Autotesters	488, 490, 491
Air Lines	493
Open/Shorts	494
Open/Shorts/Loads	495
Microwave Detectors	496, 498, 499
Power Sensors	500
Power Dividers	503, 504
Power Splitters	505, 506
Bias Tees	507, 508, 510
DC Blocks	512, 514
Universal Test Fixture	516
Limiters	517
Matching Pads	518

OUTLINE OF MICROWAVE COMPONENTS

Precision Components-Precision Measurements

Anritsu is a leader in the design and production of precision microwave components.

- Precision Coaxial Connector Systems to 65 GHz
- Precision Coaxial and Waveguide to Coax Adapters
- High Directivity SWR Autotesters and Bridges
- RF Detectors
- Precision Terminations and Air lines
- Precision Fixed Attenuators
- Precision Step Attenuators
- Precision Power Dividers and Splitters
- Precision Bias Tees
- Broadband Microwave Limiters



Connector Design Leadership

Anritsu is the leader of high frequency microwave connector technology and is driven by an ongoing commitment to exceed customer needs. Anritsu created and trademarked the K Connector® with coverage to 40 GHz, along with a complete family of 40 GHz test equipment. It was an immediate success and today is used on many commercial components, test fixtures, and military systems.

The V Connector® offers coaxial coverage to 65 GHz and uses a 1.85 mm geometry endorsed by the International Electrotechnical Commission (IEC). It mates with commercially available 2.4 mm connectors.



Coaxial and Waveguide to Coax Adapters

A series of precision measurement adapters are available to adapt one connector type to another. Adapter VSWR (or poor return loss) can be a major source of measurement error and, therefore, must be carefully selected. Anritsu precision adapters typically have 6-12 dB better return loss than competitive units. Waveguide-to-Coax Adapters are available to 65 GHz.



Precision Terminations and Air Lines

Anritsu is recognized as the leader in the field of impedance standards. Anritsu air lines and terminations are unsurpassed for accuracy and impedance match. Not only do these products increase measurement accuracy, they also provide the only method of certifying the performance of SWR Autotesters, bridges, directional couplers, and other devices.



Precision Fixed Attenuators

Anritsu attenuators offer superior performance in a low cost package. The low VSWR (excellent return loss) minimizes signal reflections and simultaneously reduces ripple effects in the output frequency response. This assures flat, consistent attenuation characteristics regardless of other device's reflection characteristics. One of the simplest ways to improve impedance match is to insert a precision attenuator between the device under test and the source or RF detector. The 41K and 41V Series attenuators are specifically designed for such applications where accuracy is a basic requirement.

In addition to being available as individual units of 3, 6, 10, or 20 dB, the 41K and 41V Series Fixed Attenuators are also available in sets with certified calibration data. Available frequency ranges cover DC to 26.5 GHz, 40 GHz, or 60 GHz.

Many other attenuator applications have as their principal objective the reduction of power. Since the attenuator might not be inserted at a measurement point, the measurement precision discussed earlier is not required. In such a power-reducing system application, attenuators are often required in large quantities, making price an important consideration. The 43K Series includes models covering DC to 26.5 GHz, and DC to 40 GHz. All are available with 3, 6, 10, or 20 dB attenuation values. All have the Anritsu K Connectors and are compatible with SMA connectors.

Whatever your fixed attenuator needs might be, Anritsu provides the solution.

Precision Step Attenuators

Anritsu offers low loss, high precision step attenuators. These programmable step attenuators are available with 10 dB steps from 0 to 70 dB or 0 to 110 dB ranges. DC to 40 GHz frequency range ensures the broadest attenuation and frequency coverage available. Contact Anritsu for needs above 40 GHz.

Precision Power Dividers and Splitters

Anritsu produces precision V Connector® dividers and splitters to 60 GHz and precision K Connector® dividers and splitters to 40 GHz. All Anritsu power dividers are 3-resistor symmetrical designs with excellent amplitude and phase tracking. Anritsu power splitters are 2-resistor designs, used to accurately split signals for ratio measurements.

Precision Bias Tees

Anritsu Bias Tees are used to combine DC and RF for active device measurements. Low RF throughline loss and low SWR ensure negligible effect on measurements to 60 GHz.

Broadband Microwave Limiters

Anritsu broadband microwave limiters provide the widest frequency range available in a limiter. Designed to protect sensitive microwave equipment, these limiters incorporate unique single-side limiting to provide soft limiting characteristics over 10 MHz to 26.5 GHz.

High Directivity SWR Autotesters and Bridges

SWR Autotesters and SWR Bridges are directional measurement devices that separate the incident and the reflected signals of a device under test. The reflected component can then be compared to the incident signal to determine the difference between the device's impedance and its characteristic impedance.

An SWR bridge adds a precision termination inside the bridge, eliminating the need for an external reference. An autotester further simplifies the user interface by incorporating a detector into the RF output that provides a DC output proportional to the DUT mismatch.

The directivity of the SWR Autotester or bridge is the measure of how well the incident and reflected signals can be separated. For example, 40 dB directivity means that the error signal in the output is 40 dB below the reflected signal to be measured.

Anritsu's high directivity bridges and autotesters set the standards for reflection measurements. High directivity translates to accurate measurements. Anritsu high directivity bridges are available for GPC-7, 50Ω and 75Ω Type N. High directivity autotesters are available with GPC-7, Type N, and SMA, 3.5, K Connectors®, and V Connectors®.

RF Detectors

Just as directivity is the principal error contributor in reflection measurements, the impedance match of the signal source and RF detector is a significant error contributor in transmission measurements. Anritsu offers a complete line of coaxial RF detectors covering from 100 kHz to 50 GHz with the lowest SWR available. The excellent impedance match of the detectors, along with that of the test port on the SWR Autotesters and bridges, minimize errors when making simultaneous transmission and measurements.

Calibration and Verification Kits

Anritsu offers calibration kits which contain all the precision components and tools required to calibrate an Anritsu VNA in a connector style of your choice. The calibration kits are described on pages 372 through 374.

Specials

Anritsu also manufactures assemblies and components to meet specific customer requirements in both coaxial and waveguide structures. These include such components as Connectors, Bias Tee, Step Attenuator, Detector, Waveguide and Coaxial Adapters, RF Cables etc.

When requesting quotations on special assemblies, please provide as minimum information: frequency range, electrical characteristics, mechanical details and outline dimensions if any.

CONNECTORS

K Connector®

DC to 40 GHz

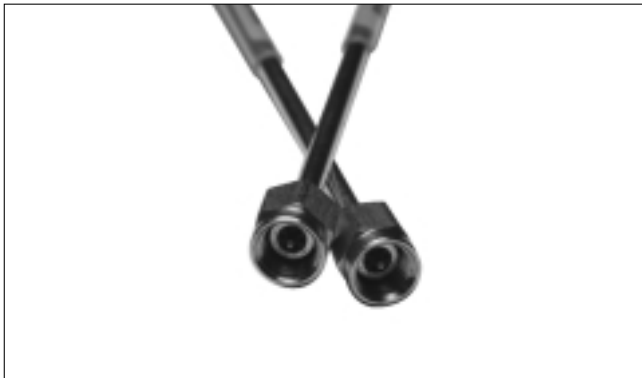

The K Connector® is a precision coaxial connector system that operates up to 40 GHz. It is compatible with SMA, WSMA, and 3.5 mm connectors. It is well suited to applications in components, systems, or instrumentation.

K Connector® features

- Excellent performance up to 40 GHz
- Performance exceeding SMA below 18 GHz
- Superior reliability
- Compatibility with SMA, WSMA, and 3.5 mm
- Complete testability on existing network analyzers

Exceptional reliability and repeatability

Microwave connector reliability is affected by insertion force, outer conductor strength, stress relief while mating, and mating alignment. The K Connector® exhibits exceptional performance in all of these areas.

For proper seating, a standard SMA or 3.5 mm connector can require in excess of 27N* of insertion force. In contrast, the K Connector® requires only 2.3N*. The reduced wear on the female center conductor improves reliability. In addition, the K Connectors® outer conductor is four times thicker than that of SMA. Taken together, the lower insertion force and the thicker wall offer more reliable connections than available from an SMA connector. Life tests show that the K Connector® makes greater than 10,000 connections with negligible change in electrical characteristics.

All K Connectors, including the cable connectors, incorporate a feature that eliminates a major cause of connector failure; misalignment of the male pin with respect to the female contacts. To solve the problems the K Connector® male pin is deliberately made shorter than the SMA or 3.5 mm pin. With this arrangement, the outer housing is properly aligned prior to the mating of the center conductors. Thus a proper, non-destructive alignment before mating is ensured.

The effect of pin gap on a connection is often overlooked, but is the dominant source of error in many connection systems. Pin gap is the short length of smaller diameter caused when a connector pair is mated. Pin gap causes a discontinuity at the connector interface. The K Connector® has considerably less susceptibility to pin gap than either SMA or 3.5 mm connectors.

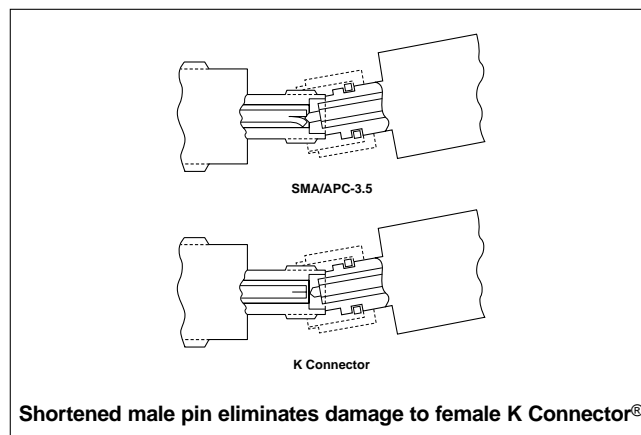

Compatibility

The K Connector® interfaces electrically and mechanically with 3.5 mm connectors, including SMA and 3.5 mm without degradation in performance.

Launcher design

At the heart of the K Connector® product line are the launchers. As their name implies, the launchers “launch” (make the transition) from a microwave circuit (microstrip, suspended substrate, stripline, or coplanar waveguide) to a coaxial connector and an outside transmission line. The key to making the transition without compromising electrical and mechanical objectives is the glass bead in the launcher assembly.

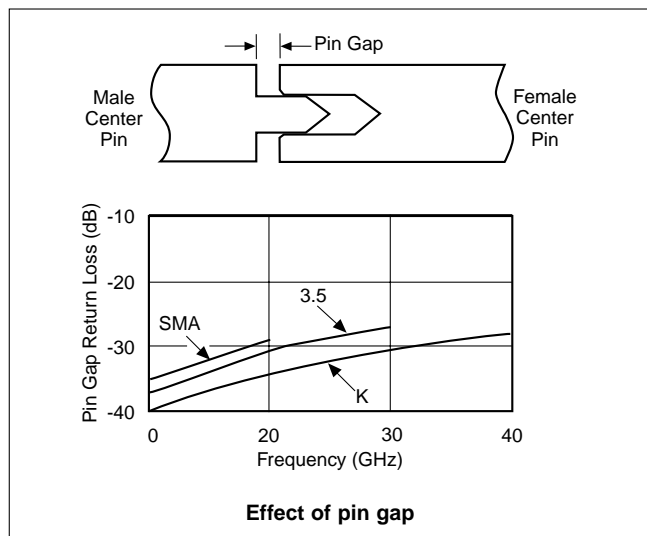

*Force is measured in Newtons (N).

Low-reflection bead

The K Connector®'s standard glass bead has a unique 0.30 mm center conductor and readily connects to fragile devices. The bead is appropriate for most applications employing Duroid® and ceramic (Alumina) microstrip, such as the 0.25 mm wide transmission line on a 0.25 mm thick Alumina substrate. Applications using suspended substrate geometry are equally well satisfied. The bead is constructed of Corning 7070 glass and has a gold-plated center conductor and a gold-plated Kovar® collar.

The outstanding design of the bead is largely accountable for the excellent performance of the K Connector® launchers. Because the small 0.30 mm pin introduces minimal discontinuity, return loss is typically better than 20 dB at 40 GHz and better than 25 dB below 18 GHz. In addition, the design provides for soldering the bead to achieve a hermetic seal. 350°C max. soldering temperature is recommended, with a 2.01 mm diameter cavity.

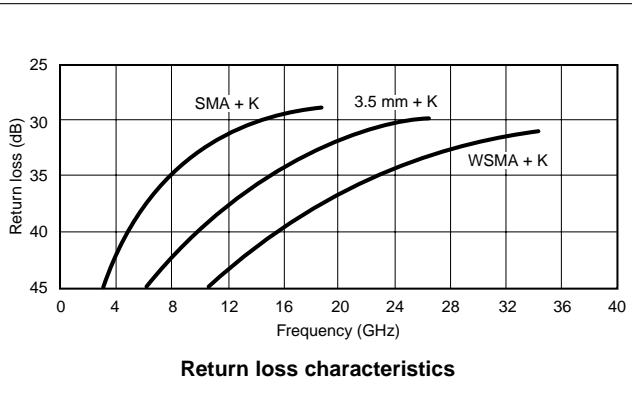
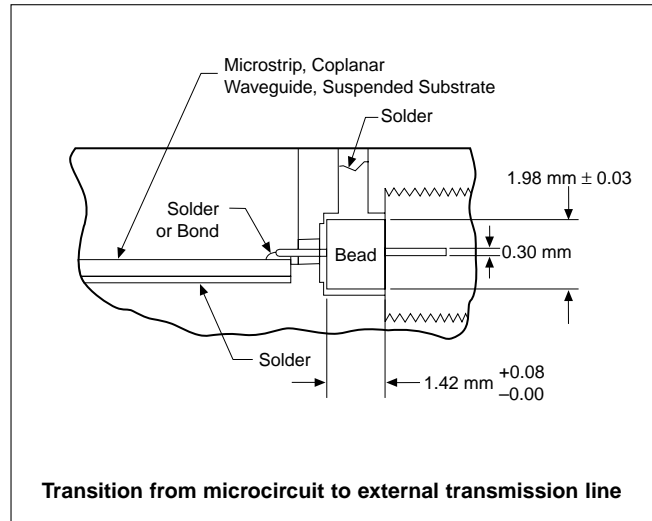

Both the sparkplug (screw-in) and the flange-mounted K Connector® launchers offer an additional advantage over existing designs. These launchers do not use an epoxy pin to secure the center conductor, as used in some SMA designs. Without an epoxy pin, the outer conductor remains solid, and thereby eliminates the leakage path common to pin-captivated designs. Furthermore, K launchers have a wall thickness that is four times that of typical launchers (0.8 vs. 0.2 mm). The heavier wall results in superior resistance to over-torquing. Finally, the K Connector® launcher can be removed for repair without removal of the glass bead. This ensures that during removal the critical microcircuit-to-glass bead interface is not disturbed, hermeticity is preserved, and the micro-circuit will not be subjected to the additional stress caused by heating to soldering temperature. Hardware locking compound such as "Removable Loctite®" should be used to further secure the launcher in its housing.

Complete family

Virtually every interface need can be satisfied by one or more of the K Connector® items offered. There are six different models of K Connector® launchers. Two sparkplug (screw-in) launchers are available – the K102F female version and the K102M male version. Both screw into the housing that encloses the microwave circuit. And, like all Anritsu launchers, they can be easily removed for replacement or repair without unsoldering the glass bead and its interface to the microwave circuit.

When the housing that encloses the microwave circuit is not thick enough to support a threaded, screw-in launcher, flush-mounted (flange) launchers are required. Models with two mounting holes are available in both male and female versions, K103M and K103F. Two other models, the K104F and K104M, have four mounting holes. Mounting hole spacing is identical to that of similar SMA flange launchers. The glass bead interface, of course, is the same design used for the sparkplug launcher.

Cable connectors

Both male and female cable connectors are available. The cable connectors, K101M and K101F, use gold-plated, beryllium-copper center conductors for optimum performance and wear characteristics. Typical return loss at 40 GHz for finished cables exceeds 16 dB (1.35 SWR).

Many connector manufacturers specify connector performance assuming no pin gap, an unrealistic assumption. K Connectors® are specified assuming pin gap to be at its maximum tolerance, to provide you the assurance of real-world specifications.

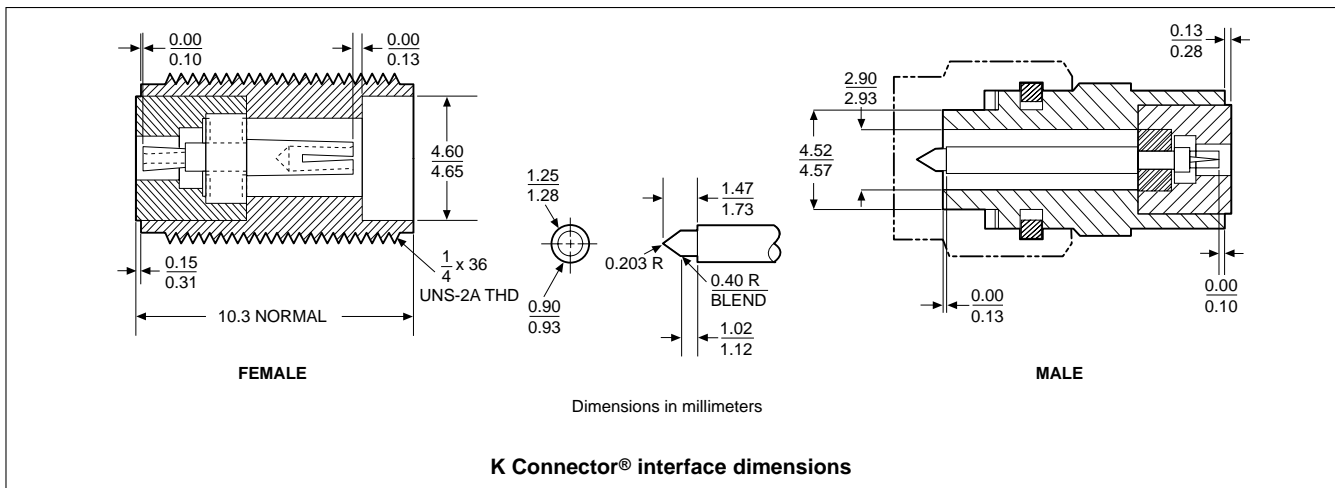

Evaluation kit

●01-101A evaluation kit

Kit contains one K120 25 cm male/male cable assembly, two K102F female sparkplug launcher connector assemblies, two K104F female flange launcher connector assemblies, five K100 glass beads, one 01-102A test fixture, one 01-104 drill and tap set, five K110-1 microstrip sliding contacts, and all other parts and fixtures required to assemble launchers with or without sliding contacts.



Tools and fixtures

●01-103 soldering fixture

For sparkplug launcher glass beads, package of 10.



●01-104 drill and tap set

For precision machining of concentric holes for mounting K Connector® in microwave housing (drill part No. B14094, tap part No. 783-255).



●01-105A male and female sparkplug torquing kit



●01-106 K soldering fixture

For flange launcher glass bead, package of 5.

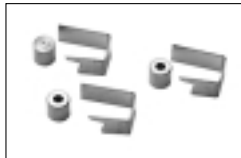

●01-107M or 01-107F cable sleeve soldering fixture

For K101M male and K101F female cable connectors, package of 10.



●01-108 drill and tap set

For precision machining of concentric holes for mounting K Connector® in microwave housing in applications where stress relief contacts are used (drill part No. B16526, tap part No. 783-255).



●01-118 K Connector® cable assembling fixture kit

For 0.118 inch semirigid coaxial cable.



Semirigid coaxial cable

Type	Semirigid coaxial, tin-plated copper outer conductor, silver-plated copper center conductor
Impedance	50 ±2 Ω
Dielectric type	Microporous Teflon, 0.24 cm diameter
Dielectric constant	1.687
Relative velocity	0.77
Outside diameter	3.00 mm
Center conductor diameter	0.81 mm
Minimum bend radius	0.65 cm
Attenuation	1.6 dB/m at 10 GHz 2.3 dB/m at 20 GHz 3.3 dB/m at 30 GHz 4.7 dB/m at 40 GHz

●K118 Semi-rigid coaxial cable

1.5 m length of 3.00 mm semi-rigid cable for K101 series connector

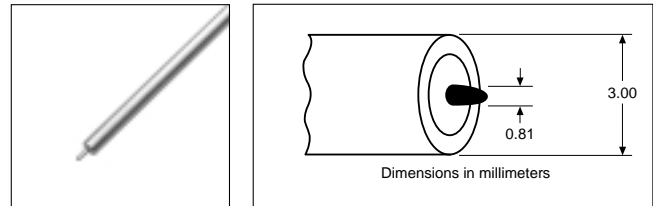

Stress relief contacts

Stress Relief Contacts provide an elegant yet simple solution to relieving stress at the interface of the microcircuit and its connecting coaxial conductor. These contacts simply slide onto the standard glass bead pins.

Frequency range	DC to 40 GHz
Material	0.025 mm heat-treated BeCu
Plating	Bondable gold
Packaging	Lots of 25

●K110-1 microstrip and coplanar waveguide

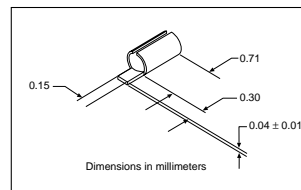

●K110-3 microstrip

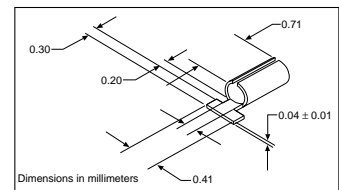

●K110-2 stripline

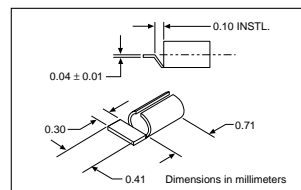

Launchers & cable connectors

Return loss (launchers only)	15 dB up to 40 GHz
Coupling nut tightening torque	1.36 N-m max
Material	Passivated stainless steel with heat-treated beryllium copper center conductors
Pin depth	0.000 to -0.13 mm for male and female connectors
Temperature range	-55° to +125°C (200°C available; contact factory)
Bead Soldering	Maximum temperature 350°C during normal soldering operations

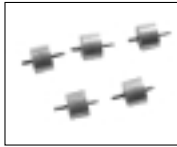

● **K100**
Glass beads for K102, K103 and K104 connectors (package of 5)

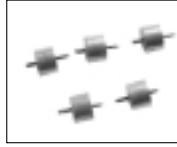

● **K100B**
High Hermeticity® Glass Beads for K102, K103, and K104 connectors



● **K101M**
K male in-line cable connector, DC to 40 GHz for 0.118 cable
● **K101M-85**
for 0.085 cable

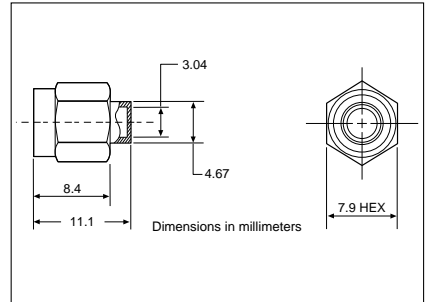
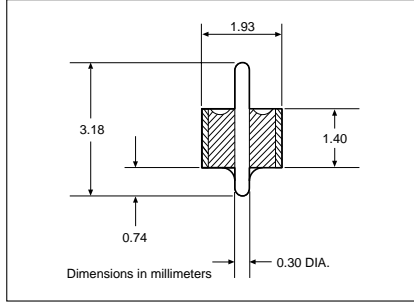
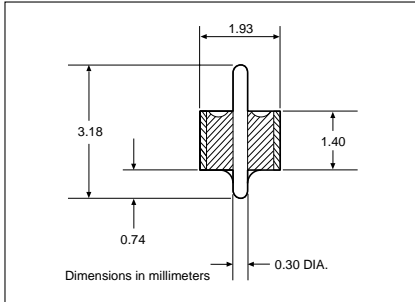

● **K101F**
K female in-line cable connector, DC to 40 GHz for 0.118 cable



● **K102M**
K male sparkplug launcher connector, DC to 40 GHz



● **K102F**
K female sparkplug launcher connector, DC to 40 GHz

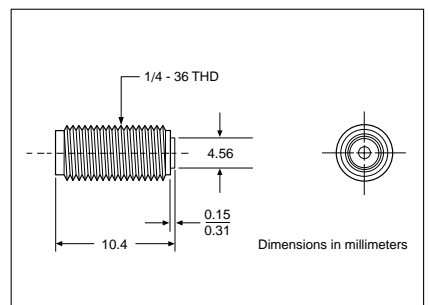
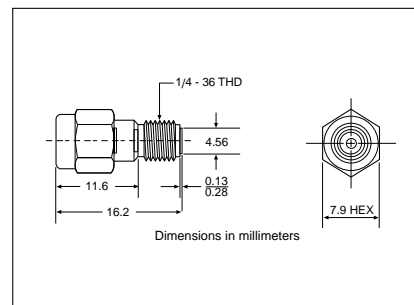
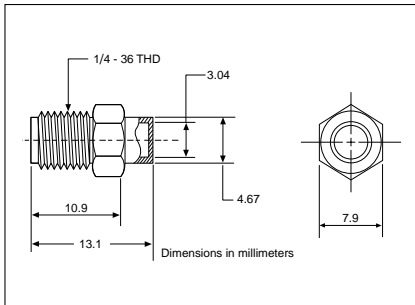

● **K103M**
K male flange launcher, two-hole, DC to 40 GHz



● **K103F**
K female flange launcher, two-hole, DC to 40 GHz



● **K104M**
K male flange launcher, four-hole, DC to 40 GHz

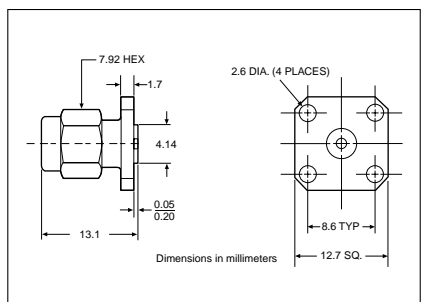
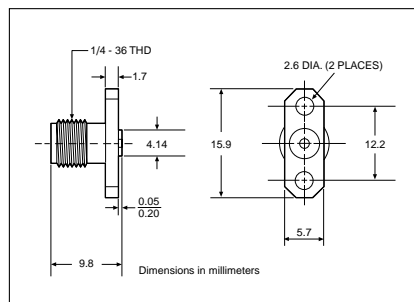
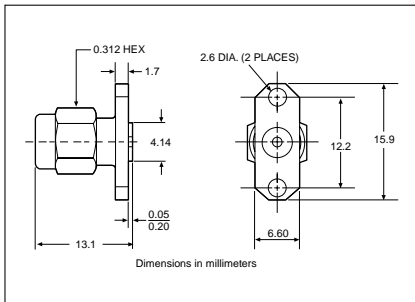

* Glass Bead Hermeticity Spec: Hermetic to 1×10^{-8} std cc He/sec at 1atm differential



● **K104F**
K female flange launcher, four-hole, DC to 40 GHz

● **K202F**
Combination of K102F, K100, K110-1

● **K202FB**
Combination of K102F, K100B, K110-1

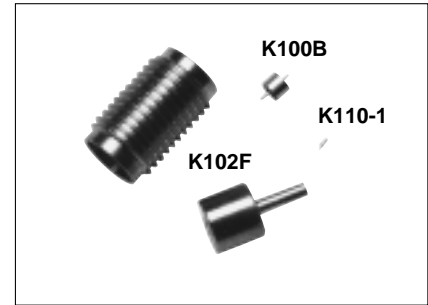
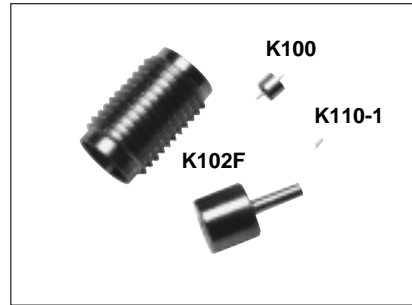
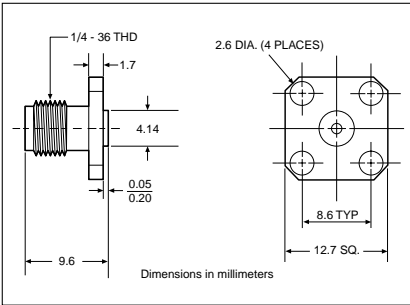

Ordering information

Please specify model/order number, name, and quantity when ordering.

Model/Order No.	Name
01-101A	K Connector® (evaluation kit)
01-103	Soldering fixture for sparkplug launcher glass bead
01-104	Drill and tap set
01-105A	Male and female sparkplug torquing kit
01-106	Soldering fixture for flange launcher glass bead
01-107F	Cable sleeve soldering fixture, female connector
01-107M	Cable sleeve soldering fixture, male connector
01-108	Drill and tap set
01-118	Cable assembling fixture for 0.118-inch semi-rigid coax cable
K110-1	Microstrip stress relief contact
K110-2	Stripline stress relief contact
K110-3	Microstrip stress relief contact
K100	Glass bead for K102/103/104 connector.
K100B	Hermetic glass bead for K102/103/104 connector.
K101M	K(m) in-line cable connector, DC to 40 GHz
K101F	K(f) in-line cable connector, DC to 40 GHz
K102M	K(m) sparkplug launcher connector, DC to 40 GHz
K102F	K(f) sparkplug launcher connector, DC to 40 GHz
K103M	K(m) flange launcher connector, DC to 40 GHz, 2 mounting holes
K103F	K(f) flange launcher connector, DC to 40 GHz, 2 mounting holes
K104M	K(m) flange launcher connector, DC to 40 GHz, 4 mounting holes
K104F	K(f) flange launcher connector, DC to 40 GHz, 4 mounting holes
K118	Coaxial cable, 1.5 m of 3.00 mm semirigid cable for K101 series connector
K202F	Combination of K100, K102F, and K110-1
K202FB	Combination of K100B, K102F, and K110-1

CONNECTORS

V Connector®

DC to 65 GHz



The V Connector® is a reliable 1.85 mm device that operates up to 65 GHz. It is compatible with 2.4 mm connectors and is assembled using procedures that are similar to those used on K Connectors. It is well suited to applications in components, systems, or instrumentation.

V Connector® features

- Excellent performance up to 65 GHz
- Low VSWR
- Superior reliability
- Low Loss

Exceptional reliability and repeatability

Microwave connector reliability is affected by insertion force, outer conductor strength, stress relief while mating, and mating alignment. The V Connector® exhibits exceptional performance in all of these areas. For proper seating, the V Connector® requires only 1/2 the insertion force of a 2.4 mm connector. The reduced wear on the center conductor equates to greater reliability. All V Connectors, including the cable connectors, incorporate another feature that eliminates a major cause of connector failure: misalignment of the male pin with respect to the female. To solve the problem, the V Connector® male pin is deliberately made sufficiently short to prevent damage to the female connector by misalignment. With this arrangement, the outer

housing must be properly aligned prior to the mating of the center conductors. Thus a proper, non-destructive alignment before mating is ensured.

The effect of pin gap on a connection is often overlooked, but is the dominant source of error in many connection systems. Pin gap is the short length of smaller diameter created when a connector pair is mated. Pin gap causes a discontinuity at the connector interface. The V Connector® has considerably less susceptibility to pin gap than 2.4 mm connectors.

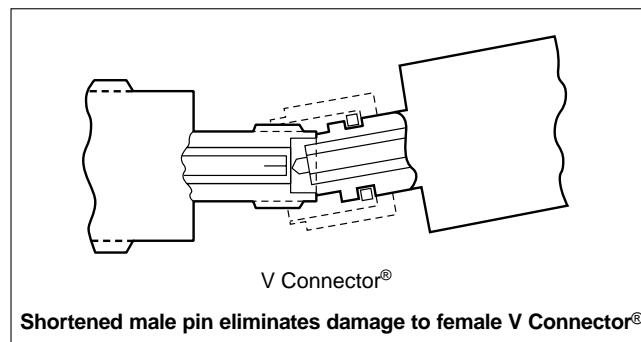

Many connector manufacturers specify connector performance assuming no pin gap, an unrealistic assumption. V Connectors® are specified assuming pin gap to be at its maximum tolerance, to provide you the assurance of real-world specifications.

Launcher design

At the heart of the V Connector® product line are the launchers. As their name implies, the launchers “launch” (make the transition) from a microwave circuit (microstrip, suspended substrate, stripline, or coplanar waveguide) to a coaxial connector and an outside transmission line. The key to making the transition without compromising electrical and mechanical objectives is the glass bead in the launcher assembly.

Low-reflection glass bead

The V Connector's standard glass bead has a unique 0.23 mm center conductor and readily connects to fragile devices. The bead is appropriate for most applications employing Duroid and ceramic (Alumina) microstrip, such as the 0.25 mm wide center conductor on a 0.25 mm thick Alumina substrate. Applications using suspended substrate geometry are equally well satisfied. The bead is constructed of Corning 7070 glass and has a gold-plated center conductor and a gold-plated Kovar® collar.

The outstanding design of the bead is largely accountable for the excellent performance of the V Connector® launchers. In addition, the design provides for soldering the bead to achieve a hermetic seal. 350°C max. soldering temperature is recommended, with a 1.80 mm diameter cavity. The V Connector® launchers can be removed for repair without removal of the glass bead. This ensures that during removal the critical microcircuit-to-glass bead interface is not disturbed, that hermeticity is preserved, and that the microcircuit will not be subjected to the additional stress caused by heating to soldering temperature. Hardware locking compound such as “Removable Loctite®” should be used to further secure the launcher in its housing.

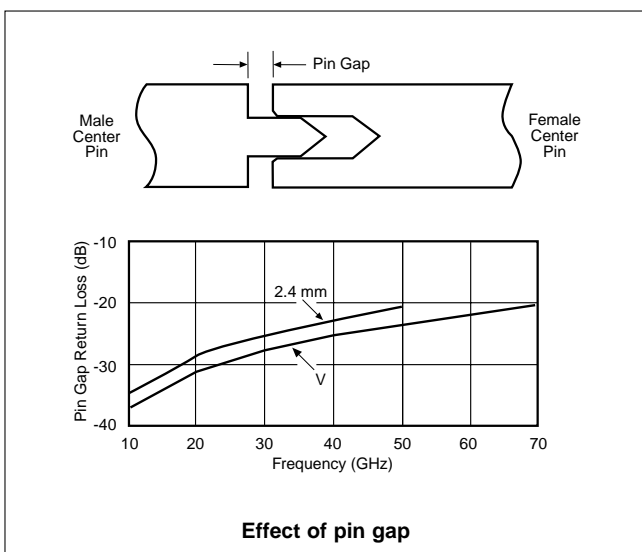

Complete family

Anritsu's family of V Connector® products is large and growing. Virtually every interface need can be satisfied by one or more of the items offered. As a convenience to the design engineer, each item is completely specified with both guaranteed and typical performance. There are four different models of V Connector® launchers. Two types of sparkplug (screw-in) launchers are available; the V102F female version and the V102M male version. Both screw into the hous-

ing that encloses the microwave circuit. And, like all Anritsu launchers, they can be easily removed for replacement or repair without unsoldering the glass bead and its interface to the microwave circuit. When the housing that encloses the microwave circuit is not thick enough to support a threaded, screw-in launcher, flush-mounted (flange) launchers are required. Models with two mounting holes are available in both male and female versions, V103M and V103F. The mounting hole spacing is identical to that of similar SMA flange launchers. The glass bead interface, of course, is the same design used for the sparkplug launcher.

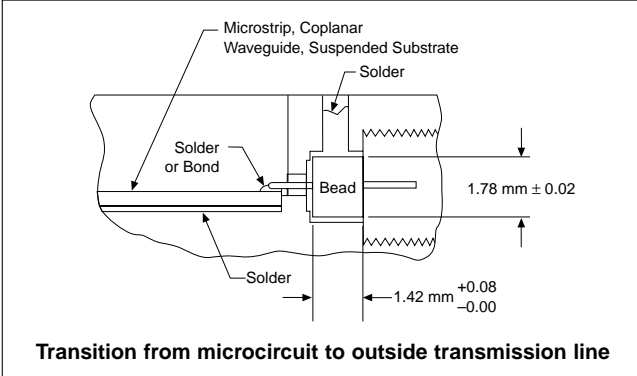

Cable connectors

To complement this high performance cable, both male and female cable connectors are available. Typical return loss at 60 GHz for finished cables exceeds 16 dB (1.35 SWR).

The V Connector® coaxial cable connectors use a 2.16 mm cable with a microporous Teflon dielectric and a copper center conductor. The cable assemblies use the center conductor of the coax as the male pin. This is similar to the UT-141 SMA-type assembly and the 2.4 mm cable assemblies. The microporous Teflon dielectric has maximum phase stability and minimum insertion loss. This type of cable assembly allows for easy assembly and maximum RF performance; however, since the male pin is copper, the cable assemblies are not suitable for repeated connections. In applications where the cable will be subject to more than 100 connections, it is recommended that a connector saver be used.

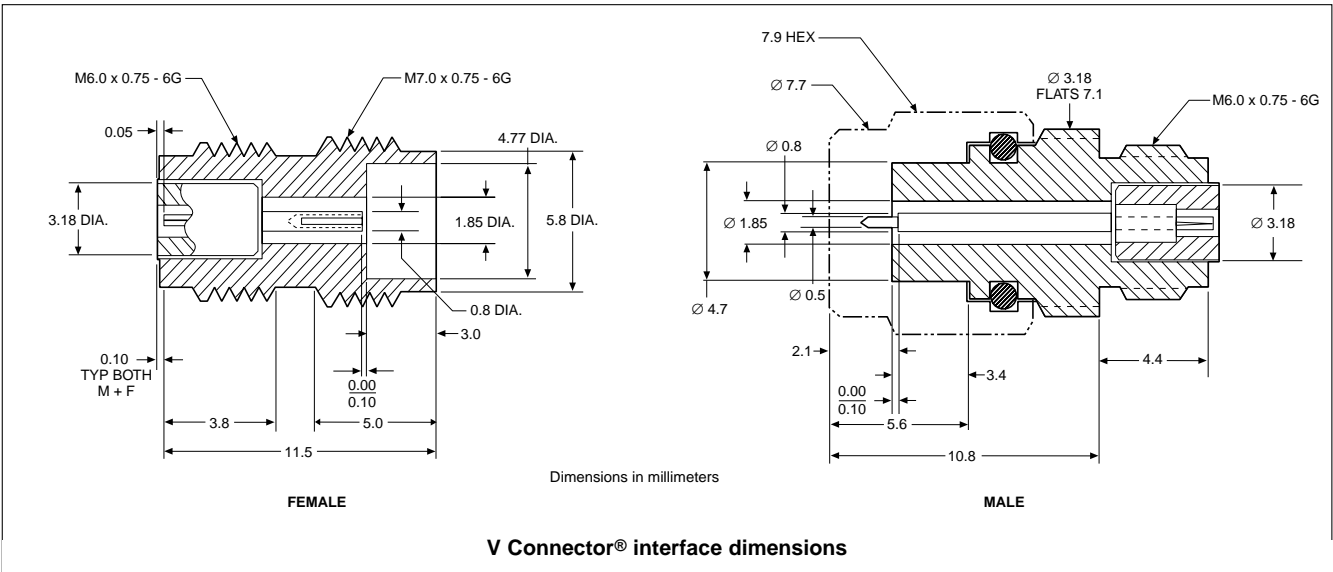

Evaluation kit

• 01-301 V Connector® evaluation kit

Kit contains one V120MM-25 cm male/male cable assembly, two V102F female sparkplug launcher connector assemblies, two V103F female flange launcher connector assemblies, two V101M male in-line cable connector assemblies, five V100 glass beads, one 01-304 drill and tap set, one 01-302 test fixture, and one 01-303 soldering fixture.



Tools and fixtures

• 01-303 soldering fixture

For sparkplug launcher glass beads, package of 10.



• 01-304 drill and tap set

For precision machining of concentric holes for mounting V Connector® in microwave housing (step drill part No. 783-568, tap part No. 783-569). For use when stress relief contacts are not being used.



- **01-105A K Connector® and V Connector® male and female sparkplug torquing kit**



- **01-306 V soldering fixture**
For flange launcher glass bead, package of 5.

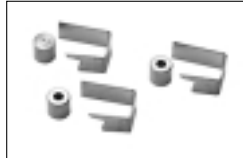

- **01-307M or 01-307F cable sleeve soldering fixture**
For V101M male and V101F female cable connectors, package of 10.

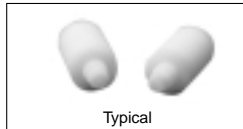

- **01-308 drill and tap set**
Where stress relief is used (step drill part # 55300, tap part # 783-569.)



- **01-309 V Connector® cable assembling fixture kit**
For 0.085 semirigid coaxial cable.



Semirigid coaxial cable

Type	Semirigid coaxial, tin-plated copper outer conductor, silver-plated copper center conductor
Impedance	50 ±2 Ω
Dielectric type	Microporous Teflon, 0.14 cm diameter
Dielectric constant	1.687
Relative velocity	0.77
Outside diameter	2.18 mm
Center conductor diameter	0.51 mm
Minimum bend radius	0.65 cm
Attenuation	2.3 dB/m at 10 GHz 3.6 dB/m at 20 GHz 4.3 dB/m at 30 GHz 5.2 dB/m at 40 GHz 7.2 dB/m at 60 GHz

- **V085 semirigid coaxial cable**
1.5 m length of 2.18 mm semirigid cable for V101 series connector

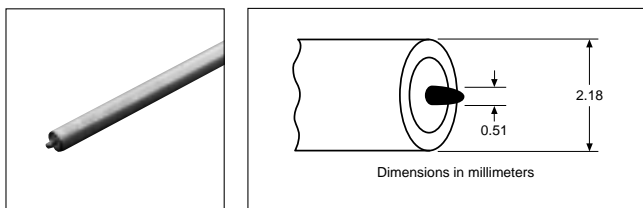

Stress relief contacts

Stress Relief Contacts provide an elegant yet simple solution to relieving stress at the interface of the microcircuit and its connecting coaxial conductor. These contacts simply slide onto the standard glass bead pins.

Frequency range	DC to 67 GHz
Material	0.025 mm heat-treated BeCu
Plating	Bondable gold
Packaging	Lots of 25

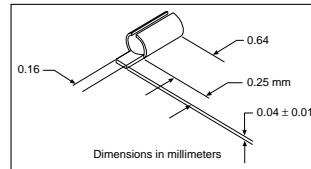

- **V110-1 microstrip and coplanar waveguide**

Launchers & cable connectors

Return loss (launchers only)	13 dB up to 65 GHz typical
Coupling nut tightening torque	1.36 N-m typical
Material	Passivated stainless steel with heat-treated beryllium copper center conductors
Pin depth	0.000 to -0.13 mm for male and female connectors
Temperature range	-55° to +125°C
Bead Soldering	Maximum temperature 350°C during normal soldering operations

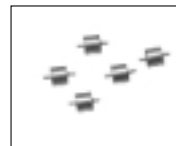

- **V100**
Glass beads for V102 and V103 connectors (package of 5)

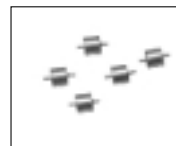
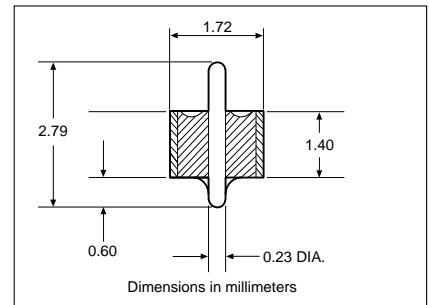

- **V100B**
High Hermeticity* Glass Beads for V102, and V103 connectors (package of 5)

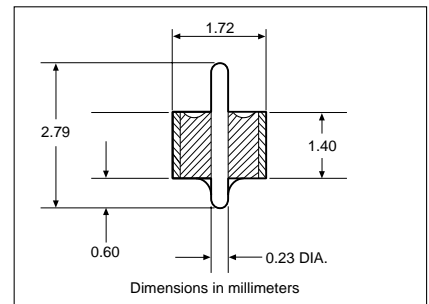

- **V101M**
V male in-line cable connector, DC to 65 GHz for V085 cable

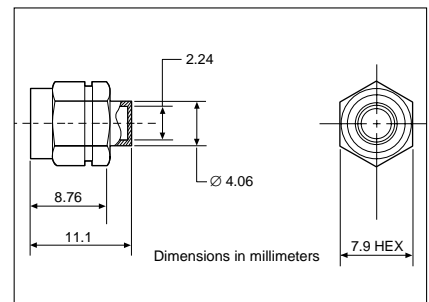

* Glass Bead Hermeticity Spec: Hermetic to 1 x 10⁻⁸ std cc He/sec at 1atm differential



• V101F
V female in-line cable connector, DC to 65 GHz for V085 cable

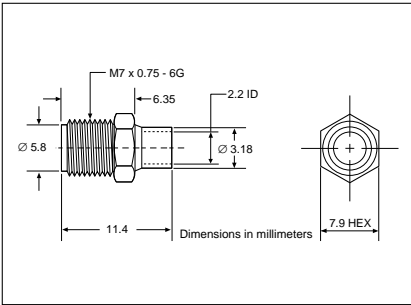

• V102M
V male sparkplug launcher connector, DC to 65 GHz

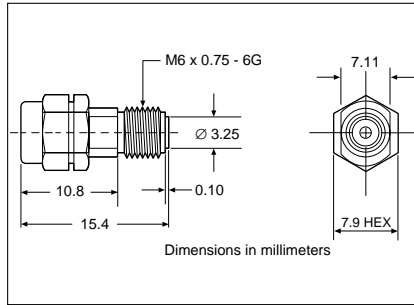

• V102F
V female sparkplug launcher connector, DC to 65 GHz

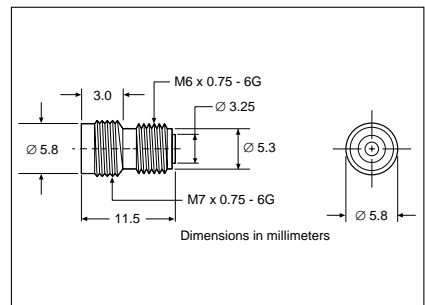

• V103M
V male flange launcher, two-hole, DC to 65 GHz

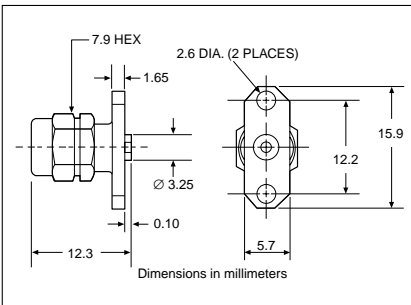

• V103F
V female flange launcher, two-hole, DC to 65 GHz

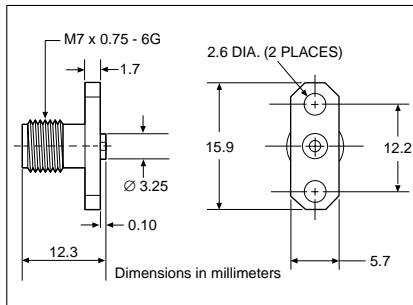

• V202F
Combination of V102F, V100, V110-1

• V202FB
Combination of V102F, V100B, V110-1

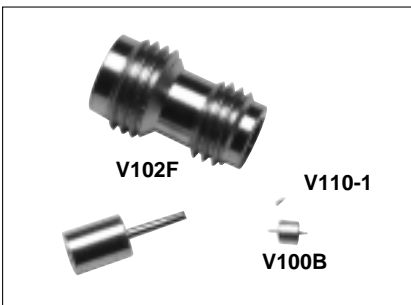

Ordering information

Please specify model/order number, name, and quantity when ordering.

Model/Order No.	Name
01-105A	Male and female sparkplug torquing kit
01-301	V Connector® (evaluation kit)
01-303	Soldering fixture for sparkplug launcher glass bead
01-304	Drill and tap set
01-306	Soldering fixture for flange launcher glass bead
01-307M	Cable sleeve soldering fixture, male connector
01-307F	Cable sleeve soldering fixture, female connector
01-308	Drill and tap set
01-309	Cable assembly fixture
V085	Coaxial cable, 152 cm (5 feet) length of 0.085-inch semi-rigid cable
V100	Glass bead for V102/103 connectors.
V100B	Hermetic glass beads for V102/103 connectors.
V101M	V(m) in-line cable connector, DC to 65 GHz
V101F	V(f) in-line cable connector, DC to 65 GHz
V102M	V(m) sparkplug launcher connector, DC to 65 GHz
V102F	V(f) sparkplug launcher connector, DC to 65 GHz
V103M	V(m) flange launcher connector, DC to 65 GHz, 2 mounting holes
V103F	V(f) flange launcher connector, DC to 65 GHz, 2 mounting holes
V110-1	Microstrip stress relief contact
V202F	Combination of V100, V102F, and V110-1
V202FB	Combination of V100B, V102F, and V110-1

Environmental specifications

Tests were done per MIL-STD-202F, unless otherwise noted.

Vibration	Sine: 10 Hz to 2000 Hz, 0.06 inches DA, 12 hours Random: 50 Hz to 2000 Hz, 11.6 Grms, Power Spectral Density of 0.1 of 0.1 Grms ² /Hz, 8 hours
Mechanical Shock	100 Gpk, sawtooth, three shocks on each axis
Humidity	95%, 40°C for 96 hours
Thermal Shock	5 cycles from 25°C to -55°C < 1 minute and 25°C to 125°C < 1 minute with 15 minute dwell at temperature extremes
Salt Spray	5% concentration spray for 48 hours
Dielectric Withstanding Voltage	500 Vrms for 60 seconds

CONNECTORS
Integrated V Connector®
 DC to 65 GHz



The Integrated V Connector® family is a group of female connectors which have the launcher and the glass bead integrated into one piece. All compensation steps for matching to Microstrip or Coplanar Waveguide (CPW) are included in the solder-in hermetic* connectors, ensuring that they deliver excellent performance. The integrated V connectors come in two easy-to-install styles: the solder-in version, which is the V115F group, and the V116F screw-in version, which allows more versatility of microcircuit launch design. In addition, the V116F can be soldered-in for hermeticity. These connectors, except for the CPW version, are designed to be used with the V110-1 Stress Relief Contacts. The Integrated V connectors are compatible with other V Connectors.

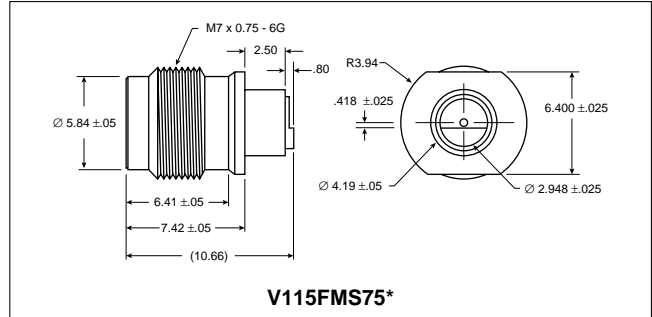

V115FMS75*
 Integrated V Female solder-in connector, with ground lip, DC to 65 GHz. Compensated for Microstrip. For use with 0.19 mm (7.5 mil) substrates.

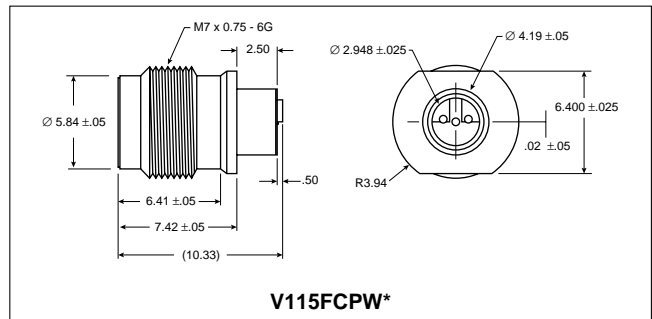

V115FCPW*
 Integrated V Female solder-in connector, with ground lip, DC to 65 GHz. Compensated for Coplanar Waveguide.

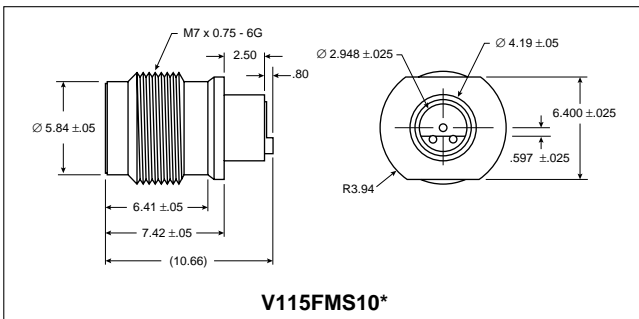

V115FMS10*
 Integrated V Female solder-in connector, with ground lip, DC to 65 GHz. Compensated for Microstrip. For use with 0.25 mm (10 mil) substrates.

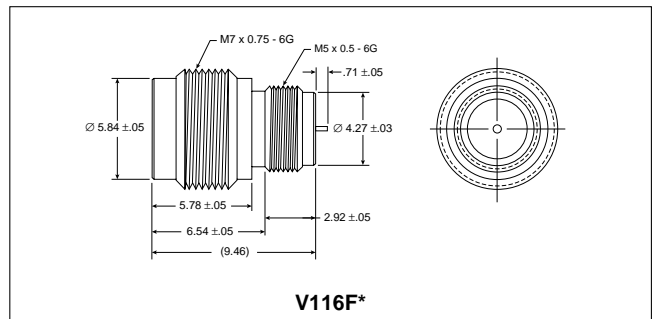

V116F*
 Integrated V Female Sparkplug (screw-in) connector, DC to 65GHz.

* Hermeticity specification: 1 x10⁻⁸ std cc He/sec at 1 atm differential.

Ordering information

Please specify model/order number, name, and quantity when ordering.

Model/Order No.	Name
V115FMS10	Integrated V(f) solder-in connector for use with 0.25 mm (10 mil) substrates
V115FMS75	Integrated V(f) solder-in connector for use with 0.19 mm (7.5 mil) substrates
V115FCPW	Integrated V(f) solder-in connector for Coplanar Waveguide
V116F	Integrated V(f) sparkplug connector

CONNECTOR TOOLS
01-201, 01-204

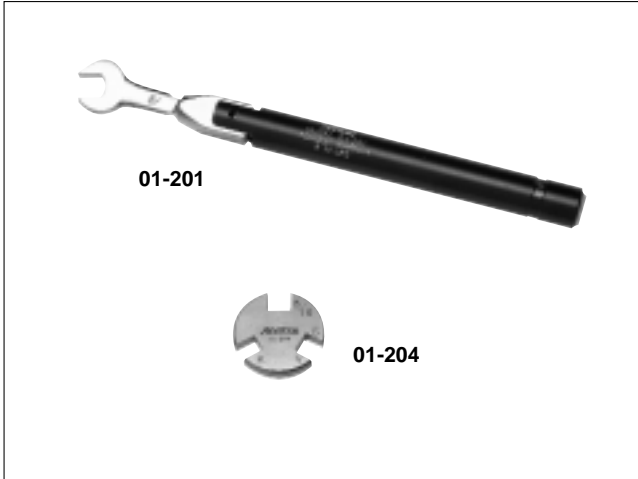

Anritsu provides two connector tools that make connecting and disconnecting tiny connectors more easily and surely accomplished. These tools are featured below.

Features

- 01-201 Torque wrench: 8 ft-lbs for standard SMA and 3.5 mm connectors, and for the Anritsu K Connector® and V Connector®.
- 01-204 Handy stainless steel connector wrench for standard SMA, 3.5 mm, and 2.4 mm connectors, and for the Anritsu K Connector® and V Connector®.

Ordering information

Please specify model/order number, name, and quantity when ordering.

Model/Order No.	Name
01-201	5/16 torque wrench, 8 in-pounds, for SMA, 3.5 mm, K Connector® and V Connector®
01-204	Anritsu stainless steel connector wrench

RF CABLES

K120, V120 Series

DC to 67 GHz

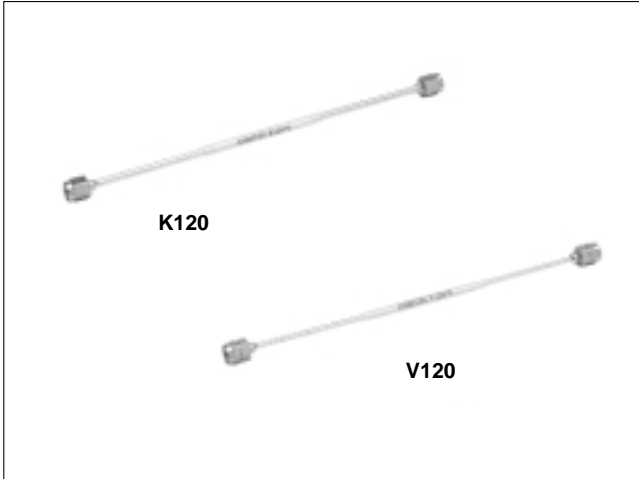

Anritsu produces precision RF cables with characteristics as shown in the tables below. Contact the Microwave Measurements Divisions for low loss, low VSWR cable bending services.

Semi-rigid RF cable features

- DC to 67 GHz frequency range
- Type N, K Connector®, and V Connector®
- K Connector® compatibility with SMA and 3.5 mm
- V Connector® compatibility with 2.4 mm

Specifications

Model	Frequency range (GHz)	Impedance (Ω)	Length	Connectors
N120-6	DC to 18	50	15 cm	N(m) - N(m)
NS120MF-6	DC to 18	50	15 cm	N(m) - SMA(f)
K120MM	DC to 46	50	See table	K(m) - K(m)
K120MF	DC to 46	50	See table	K(m) - K(f)
K120FF	DC to 46	50	See table	K(f) - K(f)
V120MM	DC to 67	50	See table	V(m) - V(m)
V120MF	DC to 67	50	See table	V(m) - V(f)
V120FF	DC to 67	50	See table	V(f) - V(f)

Temperature range: -55°C to +125°C

Semirigid coaxial cable specifications for K Connectors®

Type	Semirigid coaxial, tin-plated copper outer conductor, silver-plated copper center conductor
Impedance	50 ±2 Ω
Dielectric type	Microporous Teflon, 0.24 cm diameter
Dielectric constant	1.687
Relative velocity	0.77
Outside diameter	3.00 mm
Center conductor diameter	0.81 mm
Minimum bend radius	0.65 cm
Attenuation	1.6 dB/m at 10 GHz, 2.3 dB/m at 20 GHz, 3.3 dB/m at 30 GHz, 4.7 dB/m at 40 GHz
K118 semirigid coaxial cable	1.52m length of 0.118-inch Semirigid cable for K101 series connector

Semirigid coaxial cable specifications for V Connectors®

Type	Semirigid coaxial, tin-plated copper outer conductor, silver-plated copper center conductor
Impedance	50 ±2 Ω
Dielectric type	Microporous Teflon, 0.14 cm diameter
Dielectric constant	1.687
Relative velocity	0.77
Outside diameter	2.18 mm
Center conductor diameter	0.51 mm
Minimum bend radius	0.65 cm
Attenuation	2.3 dB/m at 10 GHz, 3.6 dB/m at 20 GHz, 4.3 dB/m at 30 GHz, 5.2 dB/m at 40 GHz, 7.2 dB/m at 60 GHz

Cable assembly part number reference

Length cm	Metric cable assemblies					
	K120MM	K120MF	K120FF	V120MM	V120MF	V120FF
5	K120MM-5CM	K120MF-5CM	K120FF-5CM	V120MM-5CM	V120MF-5CM	V120FF-5CM
10	K120MM-10CM	K120MF-10CM	K120FF-10CM	V120MM-10CM	V120MF-10CM	V120FF-10CM
15	K120MM-15CM	K120MF-15CM	K120FF-15CM	V120MM-15CM	V120MF-15CM	V120FF-15CM
20	K120MM-20CM	K120MF-20CM	K120FF-20CM	V120MM-20CM	V120MF-20CM	V120FF-20CM
25	K120MM-25CM	K120MF-25CM	K120FF-25CM	V120MM-25CM	V120MF-25CM	V120FF-25CM
30	K120MM-30CM	K120MF-30CM	K120FF-30CM	V120MM-30CM	V120MF-30CM	V120FF-30CM
35	K120MM-35CM	K120MF-35CM	K120FF-35CM	V120MM-35CM	V120MF-35CM	V120FF-35CM
40	K120MM-40CM	K120MF-40CM	K120FF-40CM	V120MM-40CM	V120MF-40CM	V120FF-40CM
45	K120MM-45CM	K120MF-45CM	K120FF-45CM	V120MM-45CM	V120MF-45CM	V120FF-45CM
50	K120MM-50CM	K120MF-50CM	K120FF-50CM	V120MM-50CM	V120MF-50CM	V120FF-50CM
60	K120MM-60CM	K120MF-60CM	K120FF-60CM	V120MM-60CM	V120MF-60CM	V120FF-60CM
70	K120MM-70CM	K120MF-70CM	K120FF-70CM	V120MM-70CM	V120MF-70CM	V120FF-70CM
80	K120MM-80CM	K120MF-80CM	K120FF-80CM	V120MM-80CM	V120MF-80CM	V120FF-80CM
90	K120MM-90CM	K120MF-90CM	K120FF-90CM	V120MM-90CM	V120MF-90CM	V120FF-90CM
100	K120MM-100CM	K120MF-100CM	K120FF-100CM	V120MM-100CM	V120MF-100CM	V120FF-100CM
125	K120MM-125CM	K120MF-125CM	K120FF-125CM	V120MM-125CM	V120MF-125CM	V120FF-125CM
150	K120MM-150CM	K120MF-150CM	K120FF-150CM	V120MM-150CM	V120MF-150CM	V120FF-150CM

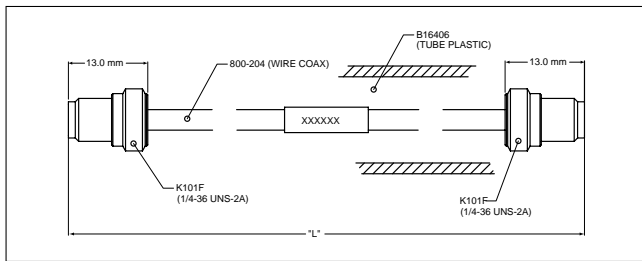

K120FF outline

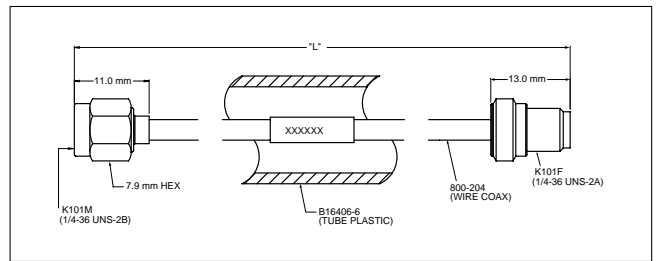

K120MF outline

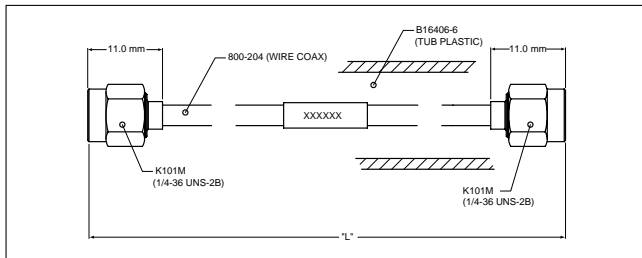

K120MM outline

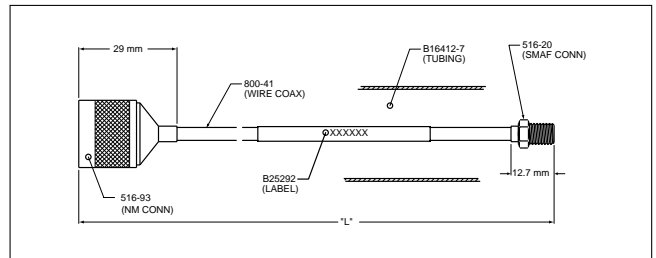

N120-6 outline

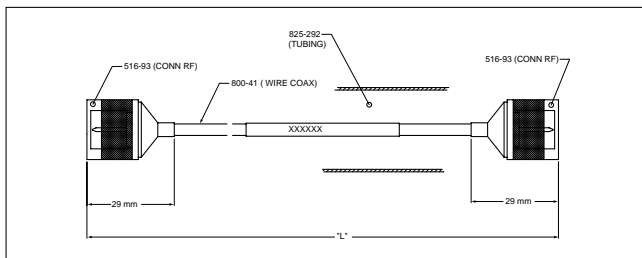

NS120MF-6 outline

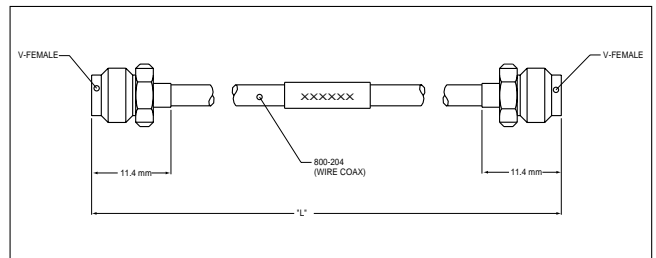

V120FF outline

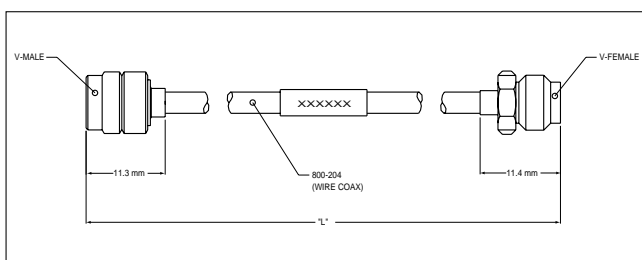

V120MF outline

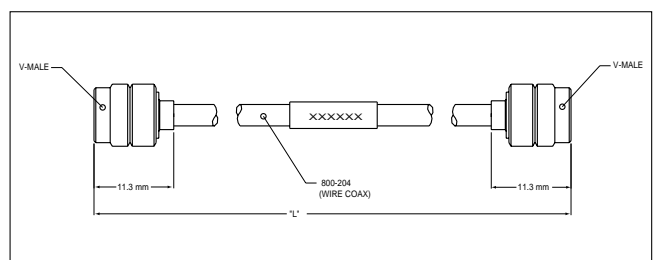

V120MM outline

COAXIAL ADAPTERS

K, V, K to V

DC to 65 GHz



The K220 and 34V Series of precision adapters enable accurate measurements with K or V connectors. Every adapter is fully specified and 100% tested to ensure low reflections and optimum performance over the DC to 60 GHz range.

Precision K and V adapter features

- K Connector® DC to 40 GHz frequency range
- V Connector® DC to 65 GHz frequency range
- Low SWR and insertion loss

Specifications

Model	Frequency range (GHz)	Connectors	SWR
K220B K222B K224B	DC to 40	K(m) to K(m) K(f) to K(f) K(f) to K(m)	1.12
34VK50 34VKF50	DC to 40	V(m) to K(m) V(m) to K(f)	1.3
34VFK50 34VFKF50	DC to 40	V(f) to K(m) V(f) to K(f)	1.3
34VV50 34VVF50 34VVF50	DC to 65	V(m) to V(m) V(f) to V(f) V(m) to V(f)	1.5

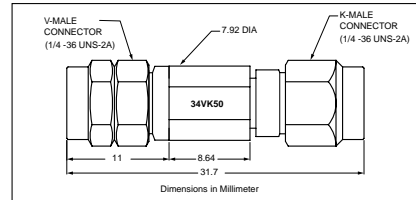

34VK50
Outline

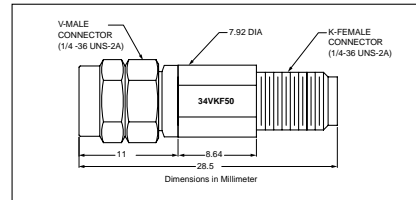

34VKF50
Outline

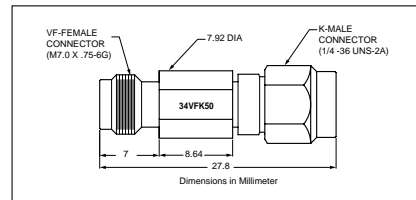

34VFK50
Outline

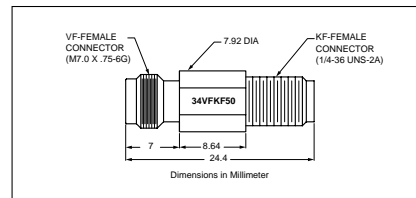

34VFKF50
Outline

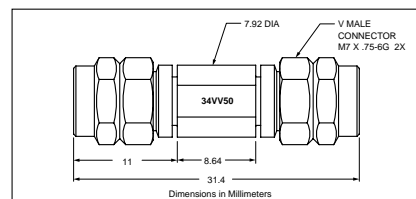

34VV50
Outline

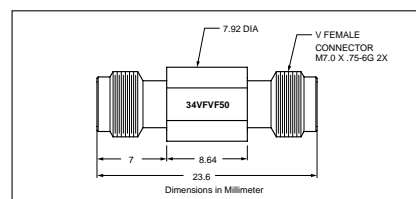

34VVF50
Outline

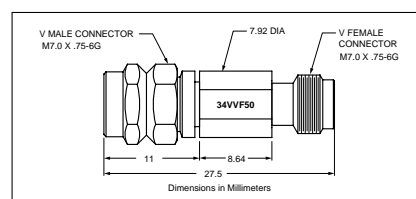

34VVF50
Outline

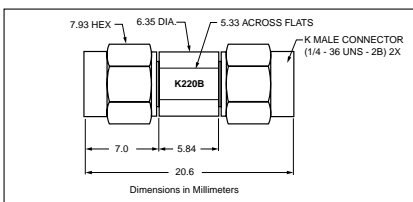

K220B
Outline

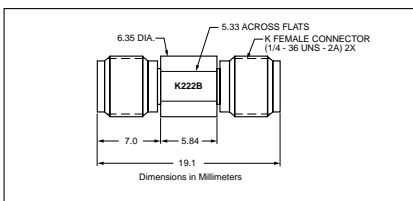

K222B
Outline

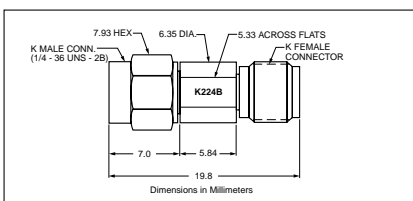

K224B
Outline

The K230 Series is the panel-mount version of the K220 Series Adapters. These units mount in a standard 9.5 mm "D" hole.

K and V panel adapter features

- Precision, panel-mounted feedthru adapter
- Broad, DC to 65 GHz frequency range

K panel adapter specifications

Model	Frequency range (GHz)	Connectors	SWR
K230B	DC to 40	K(m) to K(m)	1.12
K232B		K(f) to K(f)	
K234B		K(f) to K(m)	

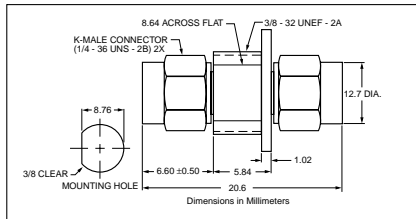

K230B outline

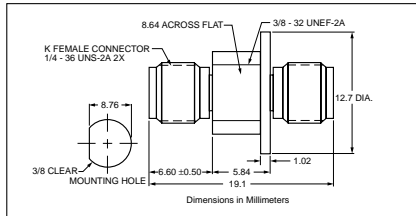

K232B outline

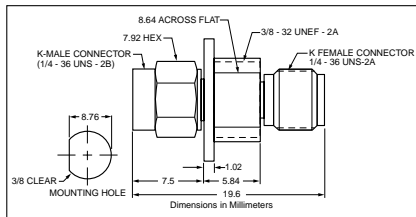

K234B outline

V panel adapter specifications

Model	Frequency range (GHz)	Connectors	SWR
K230	DC to 65	V(m) to V(m)	1.5
K232		V(f) to V(f)	
K234		V(f) to V(m)	

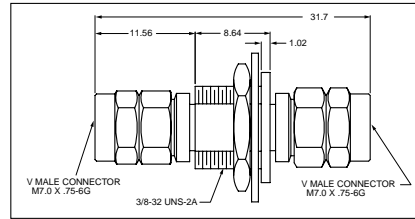

V230B Outline

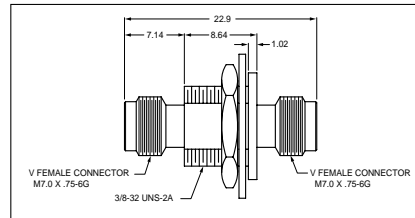

V232B Outline

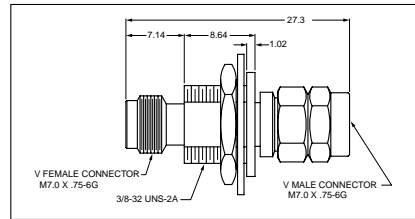

V234B outline

Ordering information

Please specify model/order number, name, and quantity when ordering.

Model/Order No.	Name
	Precision adapter
34VK50	DC to 40, V(m) to K(m)
34VKF50	DC to 40, V(m) to K(f)
34VFK50	DC to 40, V(f) to K(m)
34VFKF50	DC to 40, V(f) to K(f)
34VV50	DC to 60, V(m) to V(m)
34VVF50	DC to 60, V(f) to V(f)
34VVF50	DC to 60, V(m) to V(f)
K220B	DC to 40, K(m) to K(m)
K222B	DC to 40, K(f) to K(f)
K224B	DC to 40, K(f) to K(m)
K230B	DC to 40 GHz, Panel mount, 50 Ω K(m)-K(m)
K232B	DC to 40 GHz, Panel mount, 50 Ω K(f)-K(f)
K234B	DC to 40 GHz, Panel mount, 50 Ω K(m)-K(f)
V230B	DC to 65 GHz, Panel mount, 50 Ω V(m)-V(m)
V232B	DC to 65 GHz, Panel mount, 50 Ω V(f)-V(f)
V234B	DC to 65 GHz, Panel mount, 50 Ω V(f)-V(m)

CALIBRATION GRADE ADAPTERS

33 Series

DC to 65 GHz

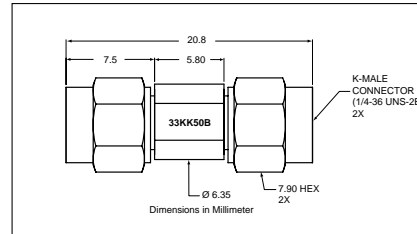
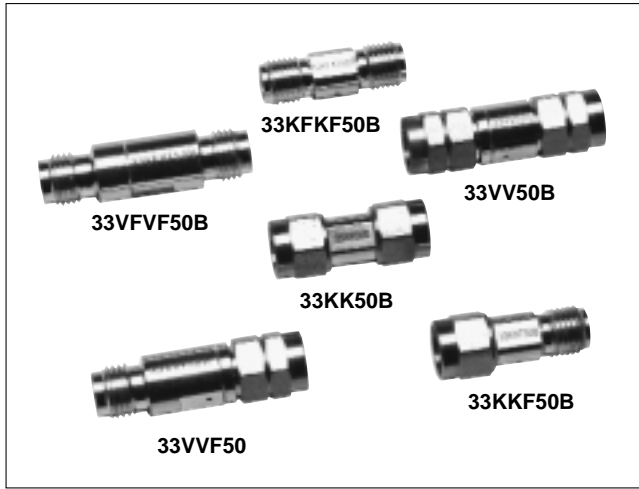

33KK50B
Outline

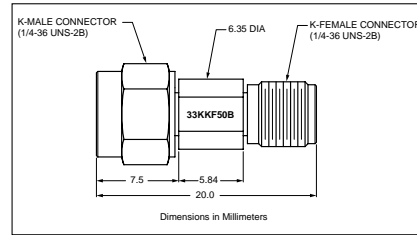

33KKF50B
Outline

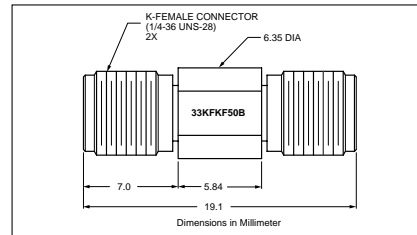

33KFKF50B
Outline

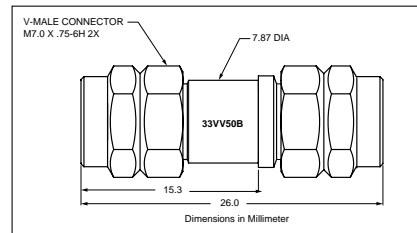

33VV50B
Outline

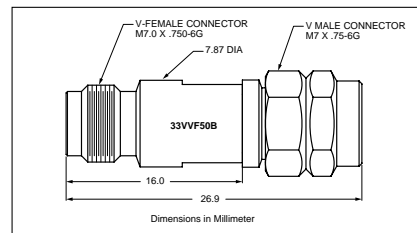

33VVF50B
Outline

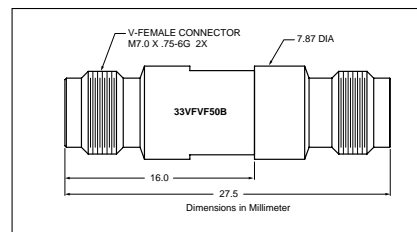

33VVF50B
Outline

The 33 Series of precision adapters enable accurate measurements with Anritsu V Connector® and K Connector® interfaces. Every adapter is fully specified and 100% tested to ensure low reflections and optimum phase performance over a broad frequency range.

Features

- Low SWR and insertion loss
- DC to 65 GHz, with V Connector® interface
- DC to 40 GHz, with K Connector® interface
- 50 Ω impedance

Specifications

Model	Frequency range (GHz)	Impedance (Ω)	Connectors	SWR
33KK50B	DC to 40	50	K(m)-K(m)	1.01
33KKF50B	DC to 40	50	K(m)-K(f)	1.07
33KFKF50B	DC to 40	50	K(f)-K(f)	1.09
33VV50B	DC to 65	50	V(m)-V(m)	1.22
33VVF50B	DC to 65	50	V(m)-V(f)	1.33
33VVF50B	DC to 65	50	V(f)-V(f)	1.33

Temperature range: -55°C to +125°C

Ordering information

Please specify model/order number, name, and quantity when ordering.

Model/Order No.	Name
	Calibration grade adapter
33KFKF50B	DC to 40 GHz, 50 Ω, K(f)-K(f)
33KK50B	DC to 40 GHz, 50 Ω, K(m)-K(m)
33KKF50B	DC to 40 GHz, 50 Ω, K(m)-K(f)
33VVF50B	DC to 65 GHz, 50 Ω, V(f)-V(f)
33VV50B	DC to 65 GHz, 50 Ω, V(m)-V(m)
33VVF50B	DC to 65 GHz, 50 Ω, V(m)-V(f)

INSTRUMENTATION GRADE ADAPTERS

34 Series



The 34 Series of precision adapters enable accurate measurements with GPC-7, Type N, or WSMA interfaces. Every adapter is fully specified and 100% tested to ensure low reflections and optimum phase performance over a broad frequency range.

Precision adapter features

- Low SWR and insertion loss
- GPC-7, Type N, and WSMA connectors
- Convenient transition with minimal effect on signal
- 50 Ω or 75 Ω impedance

34 Series specifications

Model	Frequency range (GHz)	Impedance (Ω)	Connectors	SWR	Dimensions L(cm) x dia(cm)
34NN75B 34NFN75B	DC to 3	75	N(m) to N(m) N(f) to N(f)	1.1	6.0 x 2.2 4.7 x 1.6
34AN50 34ANF50	DC to 18	50	GPC-7 to N(m) GPC-7 to N(f)	1.02	4.2 x 2.2 4.2 x 2.2
34AS50 34ASF50	DC to 18	50	GPC-7 to WSMA(m) GPC-7 to WSMA(f)	1.033	3.8 x 2.2 3.8 x 2.2
34NN50A 34NFN50	DC to 18	50	N(m) to N(m) N(f) to N(f)	1.1	6.0 x 2.2 4.7 x 1.6
34NK50 34NKF50 34NFK50 34NFKF50	DC to 18	50	N(m) to K(m) N(m) to K(f) N(f) to K(m) N(f) to K(f)	1.12	3.8 x 2.2 3.8 x 2.2 3.8 x 1.6 3.8 x 1.6
34SFSF50	DC to 26.5	50	WSMA(f) to WSMA(f)	1.11 to 1.18 to 26.5 GHz	1.6 x 0.8

The 34R Series precision adapters provide a rugged, rigid connection between Anritsu instruments with WSMA, K Connector®, or V Connector® outputs and Anritsu SWR Autotesters and SWR Bridges or other instruments.

The adapters have an outside diameter equal to that of a Type N connector, adding mechanical strength to the test setup and making installation convenient and fast.

Ruggedized adapter features

- Enhance reliability of microwave test setup
- Easy-to-grasp Type N outside diameter
- Rigid test connections for improved test data repeatability

34R Series specifications

Model	Frequency range (GHz)	Connectors	SWR	Dimensions L(cm) x dia(cm)
34RSN50	DC to 18	RS(m) to N(m)	1.40	5.1 x 2.2
34RKNF50	DC to 18	RK(m) to N(f)	1.40	5.1 x 1.7
34RVNF50	DC to 18	RV(m) to N(f)	1.40	5.1 x 1.7
34RKRK50	DC to 40	RK(m) to RK(m)	2.00	5.8 x 1.7
34RVRK50	DC to 40	RV(m) to RK(m)	2.00	5.8 x 1.7
34RVRV50	DC to 60	RV(m) to RV(m)	2.30	5.8 x 1.7

Impedance: 50Ω

Temperature range: 0°C to +75°C

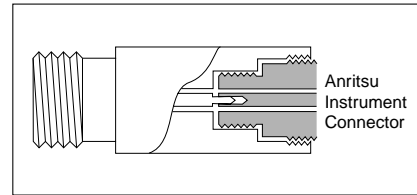

34R Series Adapter

Ordering information

Please specify model/order number, name, and quantity when ordering.

Model/Order No.	Name
	Precision adapter
34NN75B	DC to 3 GHz, 75 Ω, N(m)-N(m)
34NFN75B	DC to 3 GHz, 75 Ω, N(f)-N(f)
34AN50	DC to 18 GHz, 50 Ω, GPC-7-N(m)
34ANF50	DC to 18 GHz, 50 Ω, GPC-7-N(f)
34AS50	DC to 18 GHz, 50 Ω, GPC-7-WSMA(m)
34ASF50	DC to 18 GHz, 50 Ω, GPC-7-WSMA(f)
34NN50A	DC to 18 GHz, 50 Ω, N(m)-N(m)
34NFN50	DC to 18 GHz, 50 Ω, N (f)-N(f)
34NK50	DC to 18 GHz, 50 Ω, N (m)-K(m)
34NKF50	DC to 18 GHz, 50 Ω, N(m)-K(f)
34NFK50	DC to 18 GHz, 50 Ω, N (f)-K(m)
34NFKF50	DC to 18 GHz, 50 Ω, N(f)-K(f)
34SFSF50	DC to 26.5 GHz, 50 Ω, WSMA(f)-WSMA(f)

INSTRUMENTATION GRADE ADAPTERS

35WR Series

18 to 65 GHz



The 35 Series precision adapters transform standard or double-ridge waveguide to coaxial K Connector® and V Connector® interfaces, thus enabling convenient millimeter wave coaxial measurements.

Features

- 18 to 65 GHz frequency coverage
- K Connector® compatibility with SMA and 3.5 mm
- V Connector® compatibility with 2.4 mm
- Standard and double-ridge designs

Specifications

Model	Frequency range (GHz)	Connectors	W/G flange UG-(_) U	SWR
35WRD180K 35WRD180KF	18 to 40	WRD180 to K(m) WRD180 to K(f)	N/A	1.25
935WR42K 35WR42KF	18 to 26.5	WR42 to K(m) WR42 to K(f)	595	1.25
35WR28K 35WR28KF	26.5 to 40	WR28 to K(m) WR28 to K(f)	599	1.25
35WR22K 35WR22KF	33 to 50	WR22 to K(m) WR22 to K(f)	383	1.30
35WR22V 35WR22VF	33 to 50	WR22 to V(m) WR22 to V(f)	383	1.30
35WR19K 35WR19KF	40 to 50 Usable to 54	WR19 to K(m) WR19 to K(f)	383	1.30
35WR19V 35WR19VF	40 to 60	WR19 to V(m) WR19 to V(f)	383	1.30
35WR15V 35WR15VF	50 to 65	WR15 to V(m) WR15 to V(f)	385	1.38

Impedance: 50 Ω

Maximum input power: 1 W

Temperature range: -55°C to +125°C

Outline drawings for the 35 Series Waveguide-to-Coaxial Adapters, 18 to 65 GHz, are shown on the following two pages.

Ordering information

Please specify model/order number, name, and quantity when ordering.

Model/Order No.	Name
	Precision waveguide to coax adapter
35WRD180K	18 to 40 GHz, WRD180 (double ridge waveguide) to K(m)
35WRD180KF	18 to 40 GHz, WRD180 (double ridge waveguide) to K(f)
35WR42K	18 to 26.5 GHz, WR42-K(m)
35WR42KF	18 to 26.5 GHz, WR42-K(f)
35WR28K	26.5 to 40 GHz, WR28-K(m)
35WR28KF	26.5 to 40 GHz, WR28-K(f)
35WR22K	33 to 50 GHz, WR22-K(m)
35WR22KF	33 to 50 GHz, WR22-K(f)
35WR22V	33 to 50 GHz, WR22-V(m)
35WR22VF	33 to 50 GHz, WR22-V(f)
35WR19K	40 to 50 GHz (usable to 54 GHz), WR19-K(m)
35WR19KF	40 to 50 GHz (usable to 54 GHz), WR19-K(f)
35WR19V	40 to 60 GHz, WR19-V(m)
35WR19VF	40 to 60 GHz, WR19-V(f)
35WR15V	50 to 65 GHz (usable to 67 GHz), WR15-V(m)
35WR15VF	50 to 65 GHz (usable to 67 GHz), WR15-V(f)

Specifications

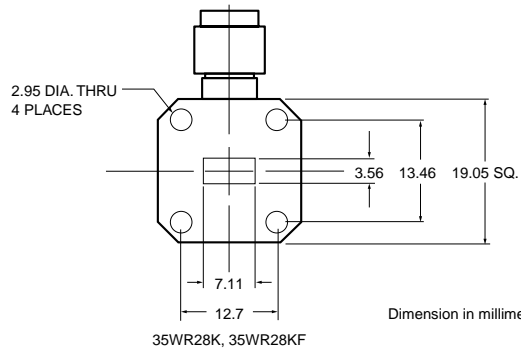
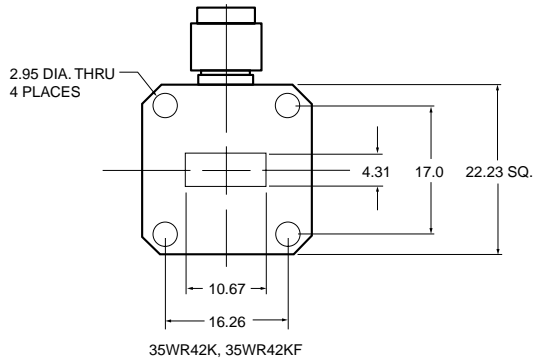
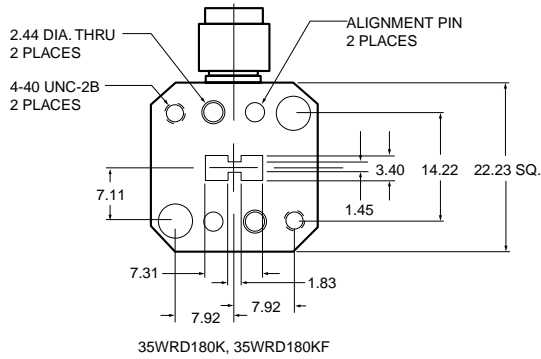
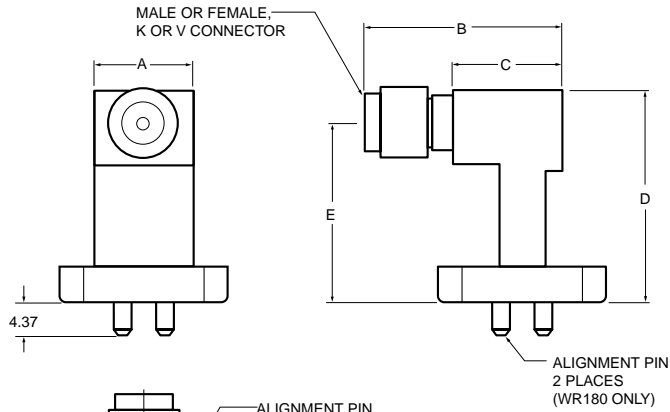

Dimension in millimeters

Model	Dimensions (mm)				
	A	B	C	D	E
35WRD180K	13.20	27.9	14.43	28.40	23.80
35WR180DKF	13.20	22.9	14.43	28.40	23.80
35WR42K	13.20	27.9	14.43	28.14	23.93
35WR42KF	13.20	22.9	14.43	28.14	23.93
35WR28K	10.67	27.9	14.86	28.78	23.93
35WR28KF	10.67	22.9	14.86	28.78	23.88

35WRD180K, 35WRD180KF, 35WR42K, 35WR42KF, 35WR28K, 35WR28KF outlines

Specifications

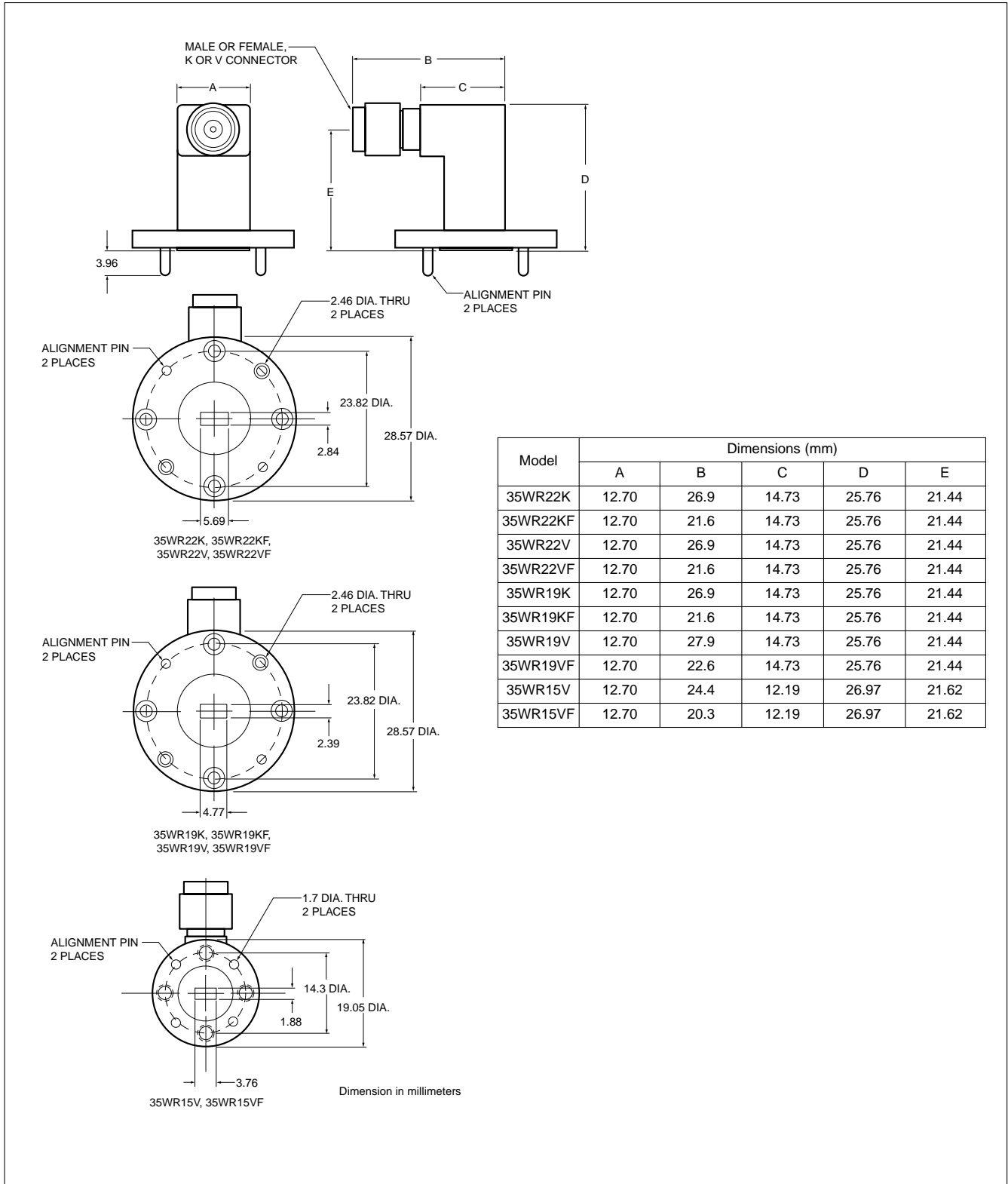

35WR22K, 35WR22KF, 35WR22V, 35WR22VF, 35WR19K, 35WR19KF, 35WR19V, 35WR19VF, 35WR15V, and 35WR15VF outlines

INSTRUMENTATION GRADE ADAPTERS

35U, 35C Series

3.3 to 26.5 GHz

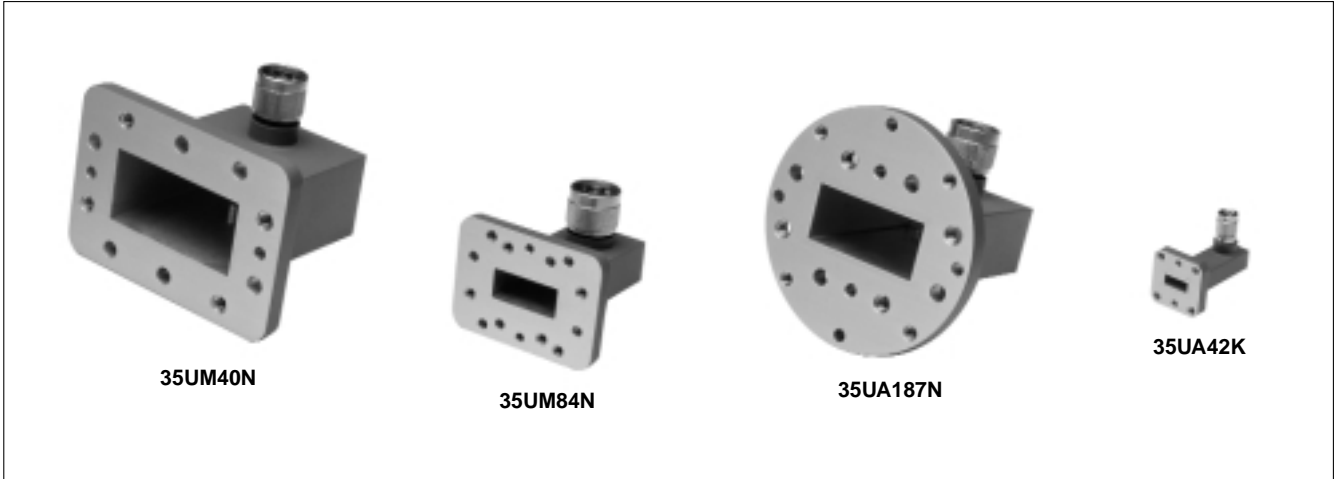

The 35U and 35C Series precision adapters transform standard waveguide to coaxial N and K Connector® interfaces, thus enabling convenient microwave coaxial measurements.

Features

- 3.3 to 26.5 GHz frequency coverage
- N connector compatibility
- K Connector® compatibility with SMA and 3.5 mm

Specifications

Model	Frequency range (GHz)	Connectors	W/G flange UG-(_) U	SWR
35UM40N	3.3 to 4.9	WR229 to N(m) WG11A to N(m)	PDR40	1.08
35UM48N	3.9 to 5.8	WR187 to N(m) WG12 to N(m)	CAR48, PAR48, UAR48, PDR48	1.08
35UM58N	4.9 to 7.0	WR159 to N(m) WG13 to N(m)	CAR58, PAR58, UAR58, PDR58	1.08
35UM70N	5.8 to 8.2	WR137 to N(m) WG14 to N(m)	CAR70, PAR70, UAR70, PDR70	1.08
35UM84N	7.0 to 10	WR112 to N(m) WG15 to N(m)	CBR84, UBR84, PBR84, PDR84	1.08
35UM100N	8.2 to 12.4	WR90 to N(m) WG16 to N(m)	CBR100, UBR100, PBR100, PDR100	1.08
35UM120N	10 to 15	WR75 to N(m) WG17 to N(m)	CBR120, UBR120, PBR120, PDR120	1.08
35UM140N	12.4 to 18	WR62 to N(m) WG18 to N(m)	CBR140, UBR140, PBR140, PDR140	1.08
35UM220K	17 to 26.5	WR42 to K(m) WG20 to K(m)	CBR220, UBR220, PBR220, PDR220	1.20
35UA229N	3.3 to 4.9	WR229 to N(m) WG11A to N(m)	CPR229F, CPR229G, UG-1350/U, UG-1351/U, UG-1726/U, UG-1727/U	1.08
35UA187N	3.9 to 5.8	WR187 to N(m) WG12 to N(m)	CPR187F, CPR187G, UG-1352/U, UG-1353/U, UG-1728/U, UG-1729/U, UG-148/U, UG-149A/U	1.08
35UA159N	4.9 to 7.0	WR159 to N(m) WG13 to N(m)	CPR159F, CPR159G, UG-1354/U, UG-1355/U, UG-1730/U, UG-1731/U	1.08
35UA137N	5.8 to 8.2	WR137 to N(m) WG14 to N(m)	CPR137F, CPR137G, UG-1356/U, UG-1357/U, UG-1732/U, UG-1733/U, UG-343B/U, UG-344/U, UG-440B/U, UG-441/U	1.08
35UA112N	7.0 to 10	WR112 to N(m) WG15 to N(m)	CPR112F, CPR112G, UG-1358/U, UG-1359/U, UG-1734/U, UG-1735/U, UG-52B/U, UG-51/U, UG-137B/U, UG-138/U	1.08

Model	Frequency range (GHz)	Connectors	W/G flange UG-(_) U	SWR
35UA90N	8.2 to 12.4	WR90 to N(m) WG16 to N(m)	CPR90F, CPR90G, UG-1360/U, UG-1361/U, UG-1736/U, UG-1737/U, UG-40B/U, UG-39/U, UG-135B/U, UG-136/U	1.08
35UA75N	10 to 15	WR75 to N(m) WG17 to N(m)	WR75	1.08
35UA62N	12.4 to 18	WR62 to N(m) WG18 to N(m)	UG-541A/U, UG-419A/U UG-1665/U, UG-1666/U	1.08
35UA42K	17 to 26.5	WR42 to K(m) WG20 to K(m)	UG-596A/U, UG-595/U, UG-597/U, UG-598A/U	1.20
35CMR229N	3.3 to 4.9	WR229 to N(m)	CMR229	1.08
35CMR187N	3.9 to 5.8	WR187 to N(m) WG12 to N(m)	CMR187, UG-1475/U, UG-148/U	1.08
35CMR159N	4.9 to 7.0	WR159 to N(m) WG13 to N(m)	CMR159	1.08
35CMR137N	5.8 to 8.2	WR137 to N(m) WG14 to N(m)	CMR137, UG-1476/U UG-1481/U	1.08
35CMR112N	7.0 to 10	WR112 to N(m) WG15 to N(m)	CMR112, UG-1477/U UG-1482/U	1.08
35CMR90N	8.2 to 12.4	WR90 to N(m) WG16 to N(m)	CMR90, UG-1478/U UG-1483/U	1.08
35UER40N	3.3 to 4.9	WR229 to N(m) WG11A to N(m)	UER40	1.08
35UER48N	3.9 to 5.8	WR187 to N(m) WG12 to N(m)	UER48	1.08
35UER58N	4.9 to 7.0	WR159 to N(m) WG13 to N(m)	UER58	1.08
35UER70N	5.8 to 8.2	WR137 to N(m) WG14 to N(m)	UER70	1.08
35UER84N	7 to 10	WR112 to N(m) WG15 to N(m)	UER84	1.08
35UER100N	8.2 to 12.4	WR90 to N(m) WG16 to N(m)	UER100	1.08

Impedance: 50 Ω

Specifications

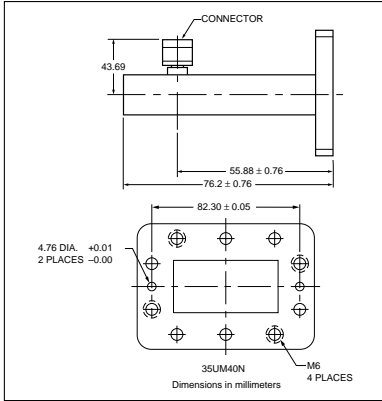

35UM40N outline

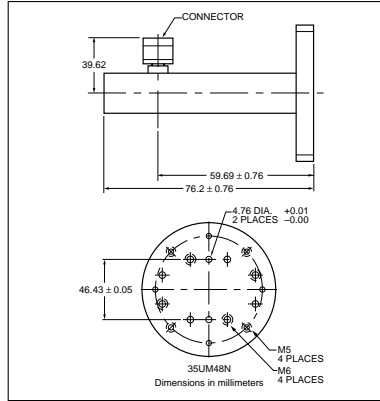

35UM48N outline

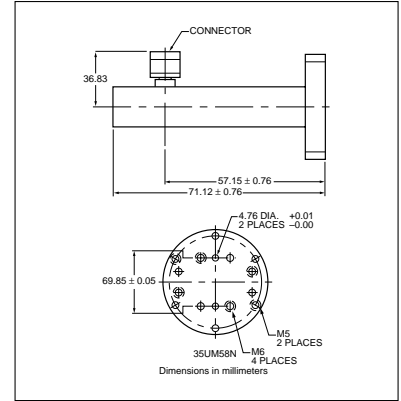

35UM58N outline

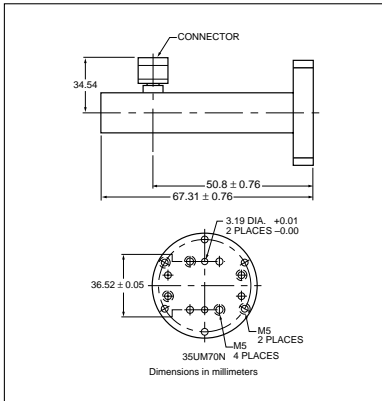

35UM70N outline

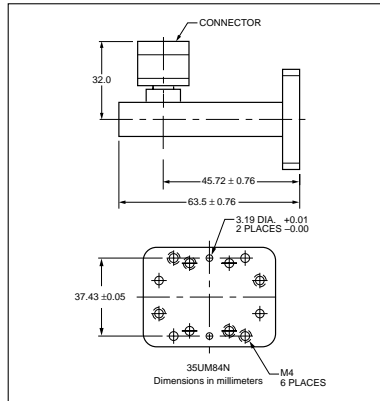

35UM84N outline

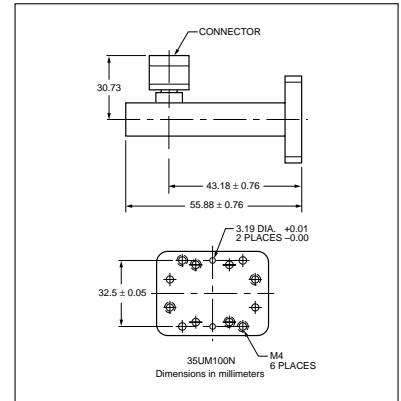

35UM100N outline

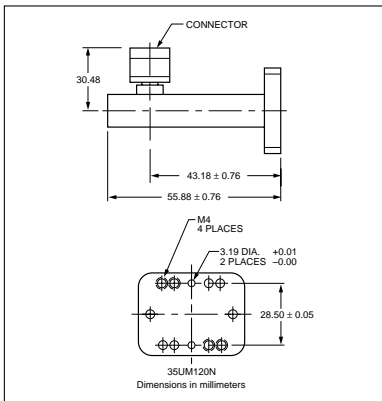

35UM120N outline

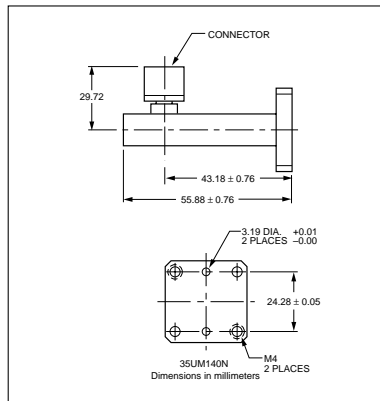

35UM140N outline

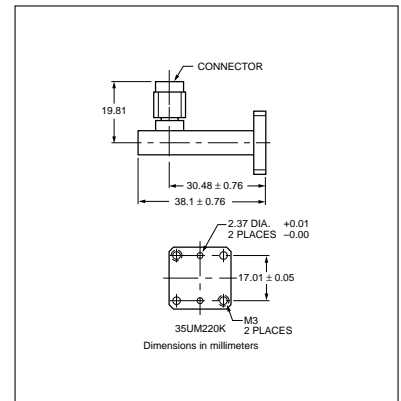

35UM220K outline

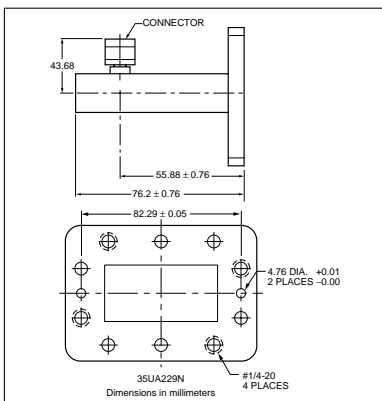

35UA229N outline

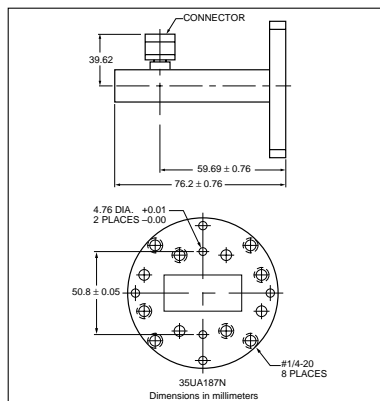

35UA187N outline

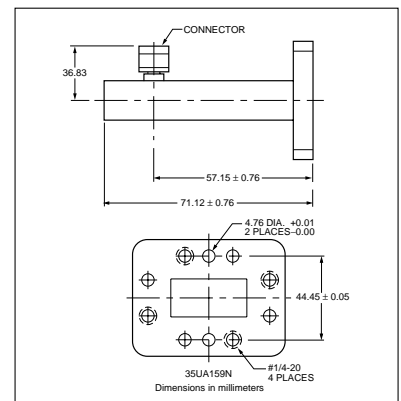

35UA159N outline

Specifications

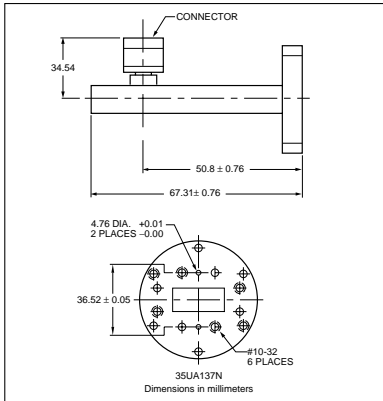

35UA137N outline

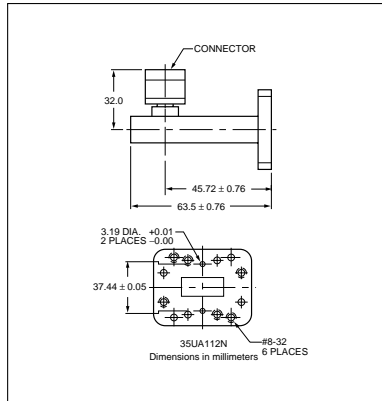

35UA112N outline

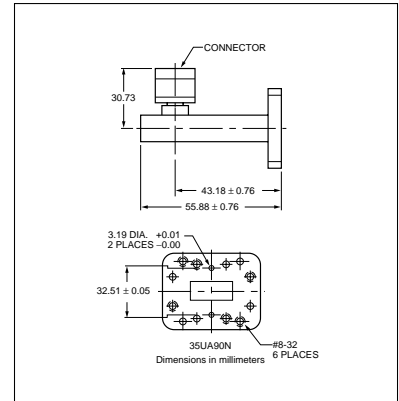

35UA90N outline

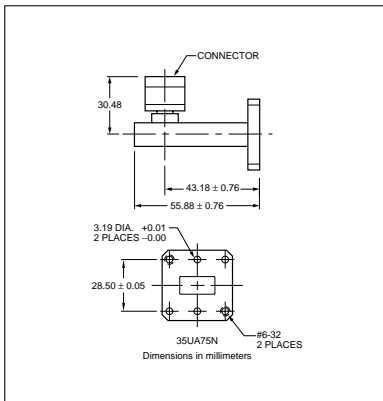

35UA75N outline

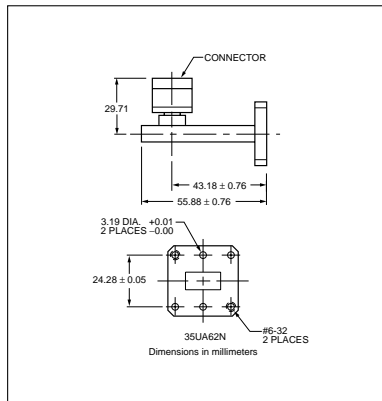

35UA62N outline

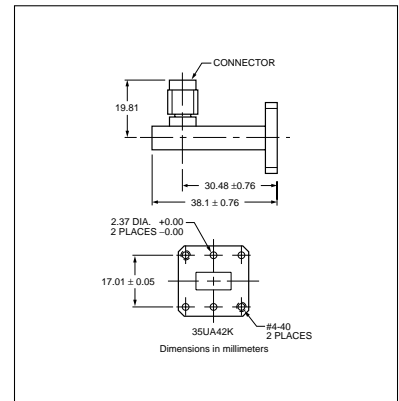

35UA42K outline

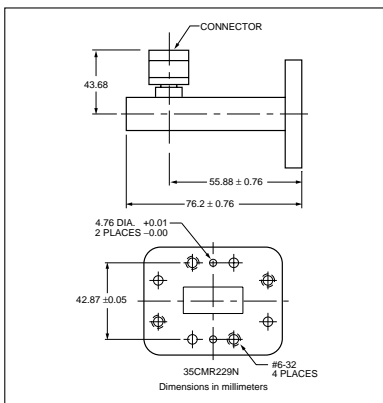

35CMR229N outline

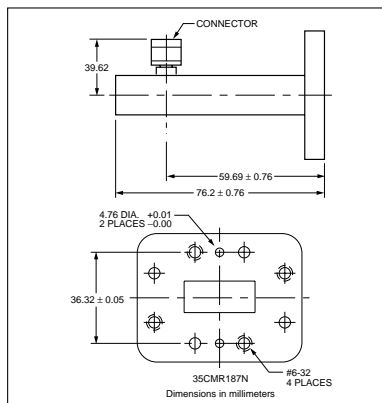

35CMR187N outline

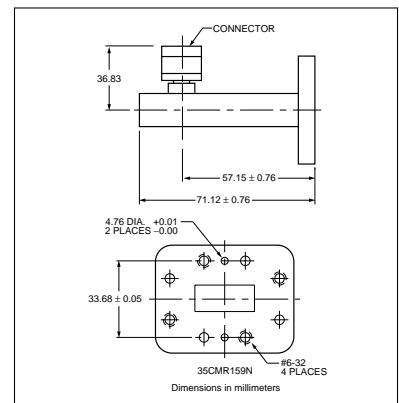

35CMR159N outline

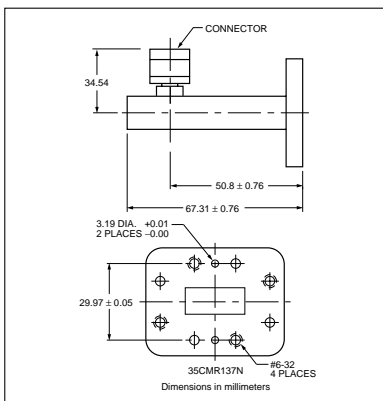

35CMR137N outline

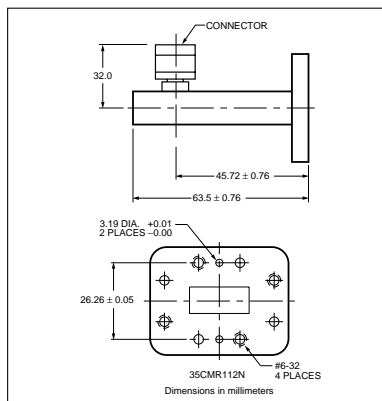

35CMR112N outline

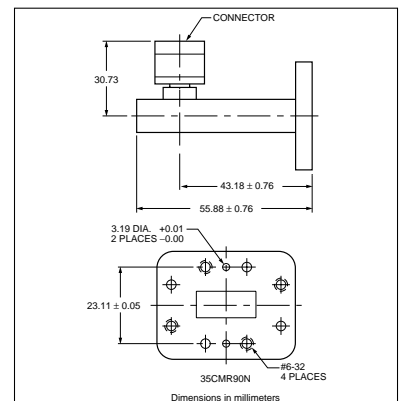

35CMR90N outline

Specifications

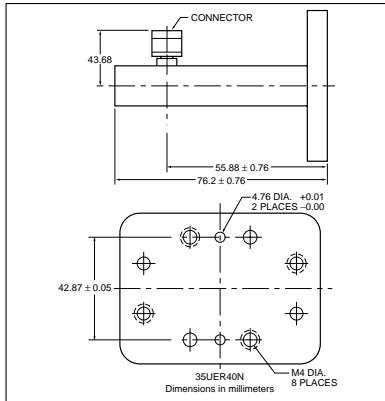

35UER40N outline

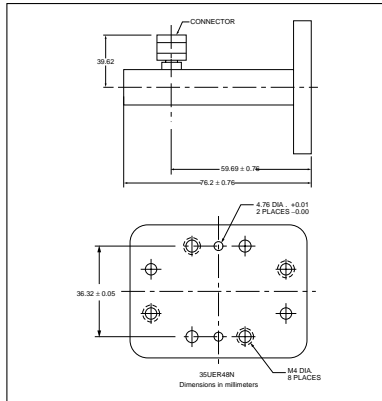

35UER48N outline

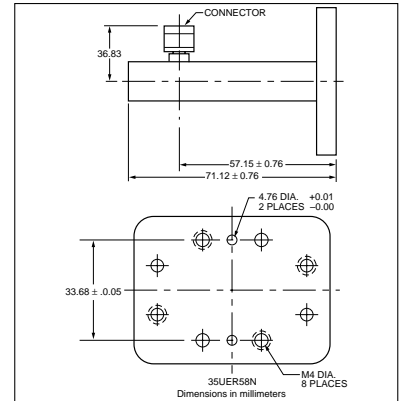

35UER58N outline

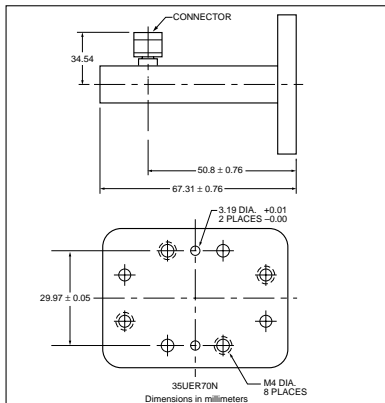

35UER70N outline

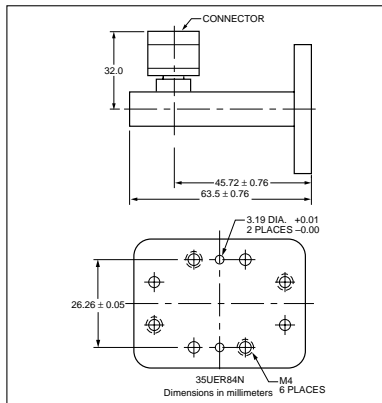

35UER84N outline

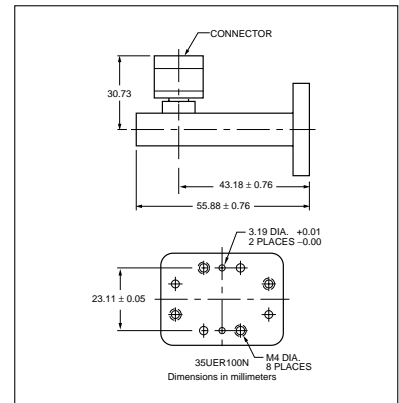

35UER100N outline

Ordering information

Please specify model/order number, name, and quantity when ordering.

Model/Order No.	Name
	Coaxial adapter
35UM40N	N(m), metric, 3.30 to 4.90 GHz
35UM48N	N(m), metric, 3.95 to 5.85 GHz
35UM58N	N(m), metric, 4.90 to 7.05 GHz
35UM70N	N(m), metric, 5.85 to 8.20 GHz
35UM84N	N(m), metric, 7.05 to 10.00 GHz
35UM100N	N(m), metric, 8.20 to 12.40 GHz
35UM120N	N(m), metric, 10.00 to 15.00 GHz
35UM140N	N(m), metric, 12.40 to 18.0 GHz
35UM220K	K(m), metric, 17.00 to 26.5 GHz
35UA229N	N(m), US, 3.30 to 4.90 GHz
35UA187N	N(m), US, 3.95 to 5.85 GHz
35UA159N	N(m), US, 4.90 to 7.05 GHz
35UA137N	N(m), US, 5.85 to 8.20 GHz
35UA112N	N(m), US, 7.05 to 10.00 GHz
35UA90N	N(m), US, 8.20 to 12.40 GHz
35UA75N	N(m), US, 10.00 to 15.00 GHz
35UA62N	N(m), US, 12.40 to 18.0 GHz
35UA42K	K(m), US, 17.00 to 26.5 GHz
35CMR229N	N(m), CMR, 3.30 to 4.90 GHz
35CMR187N	N(m), CMR, 3.95 to 5.85 GHz
35CMR159N	N(m), CMR, 4.90 to 7.05 GHz
35CMR137N	N(m), CMR, 5.85 to 8.20 GHz
35CMR112N	N(m), CMR, 7.05 to 10.00 GHz
35CMR90N	N(m), CMR, 8.20 to 12.40 GHz
35UER40N	N(m), UER, 3.30 to 4.90 GHz
35UER48N	N(m), UER, 3.95 to 5.85 GHz
35UER58N	N(m), UER, 4.90 to 7.05 GHz
35UER70N	N(m), UER, 5.85 to 8.20 GHz
35UER84N	N(m), UER, 7.05 to 10.00 GHz
35UER100N	N(m), UER, 8.20 to 12.40 GHz

COAXIAL TERMINATIONS

26, 28, 29 Series

DC to 67 GHz



These precision, metrology-grade terminations are used in measurement systems that need to achieve the smallest possible reflections. Their excellent match makes them ideal as a reference for fault location measurements on scalar network analyzers.

Precision termination features

- Accurate reference for SWR measurements
- Precise termination for test instrument or device under test

Precision termination specifications

Model	Frequency range (GHz)	Test port connector	Input impedance (Ω)	SWR (F in GHz)	Dimensions L(cm) x dia(cm)
26N75A 26NF75A	DC to 3	N(m) N(f)	75	1.013 Max.	5.2 x 2.2 4.8 x 1.6
28A50-1	DC to 18	GPC-7	50	1.02 Max.	5.2 x 2.2
28N50-2 28NF50-2	DC to 18	N(m) N(f)	50	1.02 Max.	5.2 x 2.2 4.8 x 1.6
28N50-3 28NF50-3	DC to 8	N(m) N(f)	50	1.03 Max.	5.2 x 2.2 4.8 x 1.6
28S50-1 28SF50-1	DC to 26.5	WSMA(m) WSMA(f)	50	1.020 to 18.5 GHz 1.153 to 26.5 GHz	3.7 x 1.2 3.7 x 1.2
28K50 28KF50	DC to 40	K(m) K(f)	50	1.040 to 18.5 GHz 1.070 to 26.5 GHz 1.135 to 40 GHz	3.7 x 1.2 3.7 x 1.2
28V50B 28VF50B	DC to 67	V(m) V(f)	50	1.018 to 6 GHz 1.058 to 26.5 GHz 1.074 to 40 GHz 1.12 to 60 GHz 1.25 to 67 GHz	3.7 x 1.2 3.7 x 1.2

Maximum Input Power: 0.5 W

When used with Anritsu airlines, the 29 Series Offset Terminations permit measurements down to 1.006 SWR to 18 GHz, 1.01 SWR to 26.5 GHz, and 1.02 SWR to 40 GHz.

Offset termination features

- 50 Ω Offset Terminations for precise measurement of low SWR or high directivity
- Measurements down to 1.006 SWR to 18 GHz, 1.01 SWR to 26.5 GHz, and 1.02 SWR to 40 GHz

Offset termination specifications

Model	Frequency range (GHz)	Test port connector	Return loss (dB)	Dimensions L(cm) x dia(cm)
29A50-20	DC to 18	GPC-7	20 ±0.5 to 1 GHz 20 ±1.0 to 4 GHz 20 ±1.5 to 18 GHz	5.2 x 2.2
29S50-20	DC to 26.5	WSMA(m)	20 ±1.5 to 18.5 GHz 20 ±2.5 to 26.5 GHz	3.7 x 1.2
29SF50-20	DC to 26.5	WSMA(f)	20 ±1.5 to 18.5 GHz 20 ±2.5 to 26.5 GHz	3.7 x 1.2
29K50-15	DC to 40	K(m)	15 ±1.5 to 18.5 GHz 15 ±2.5 to 26.5 GHz 15 ±3.5 to 40 GHz	3.7 x 1.2
29KF50-15	DC to 40	K(f)	15 ±1.5 to 18.5 GHz 15 ±2.5 to 26.5 GHz 15 ±3.5 to 40 GHz	3.7 x 1.2

Temperature range: +25°C ±5°C

Ordering information

Please specify model/order number, name, and quantity when ordering.

Model/Order No.	Name
26N75A 26NF75A 28A50-1 28N50-2 28NF50-2 28N50-3 28NF50-3 28S50-1 28SF50-1 28K50 28KF50 28V50B 28VF50B	Precision termination DC to 3 GHz, 75 Ω, N(m) DC to 3 GHz, 75 Ω, N(f) DC to 18 GHz, 50 Ω, GPC-7, Max. SWR=1.02 DC to 18 GHz, 40 dB, 50 Ω, N(m) DC to 18 GHz, 40 dB, 50 Ω, N(f) DC to 8 GHz, 50 Ω, N(m) DC to 8.6 GHz, 50 Ω, N(f) DC to 26.5 GHz, 50 Ω, WSMA(m) (selected for higher accuracy) DC to 26.5 GHz, 50 Ω, WSMA(f) (selected for higher accuracy) DC to 40 GHz, 50 Ω, K(m) DC to 40 GHz, 50 Ω, K(f) DC to 65 GHz, V(m) DC to 65 GHz, V(f)
29A50-20 29S50-20 29SF50-20 29K50-15 29KF50-15	Offset termination DC to 18 GHz, 50 Ω, GPC-7, 20 dB return loss DC to 26.5 GHz, 50 Ω, WSMA(m), 20 dB return loss DC to 26.5 GHz, 50 Ω, WSMA(f), 20 dB return loss DC to 40 GHz, 50 Ω, K(m), 15 dB return loss DC to 40 GHz, 50 Ω, K(f), 15 dB R return loss

COAXIAL TERMINATIONS

K210, V210

DC to 40 GHz, DC to 60 GHz



These economy-grade 50Ω terminations provide good return loss for use when a small amount of reflection won't be an issue. These terminations are intended for use as circuit terminators; they are not intended for use as calibration standards.

Features

- Good return loss
- Economical
- Maximum Input power 0.5 W

Specifications

Model	Frequency range	Return loss	Connector
K210	DC to 40 GHz	26 dB to 18 GHz 19 dB to 40 GHz	K(m)
V210	DC to 60 GHz	23 dB to 18 GHz 18 dB 18 to 26.5 GHz 16 dB 26.5 to 40 GHz 14 dB 40 to 60 GHz	V(m)

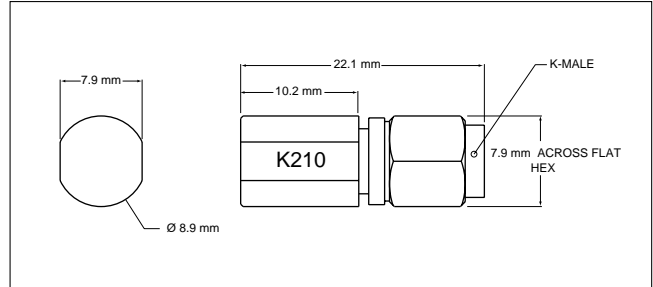

K210 outline

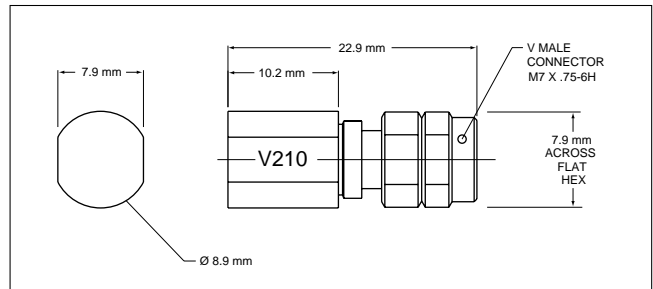

V210 outline

Ordering information

Please specify model/order number, name, and quantity when ordering.

Model/Order No.	Name
K210	50 Ω termination, K(m), 19 dB to 40 GHz
V210	50 Ω termination, V(m), 14 dB to 60 GHz

FIXED ATTENUATORS

41, 43 Series

DC to 60 GHz

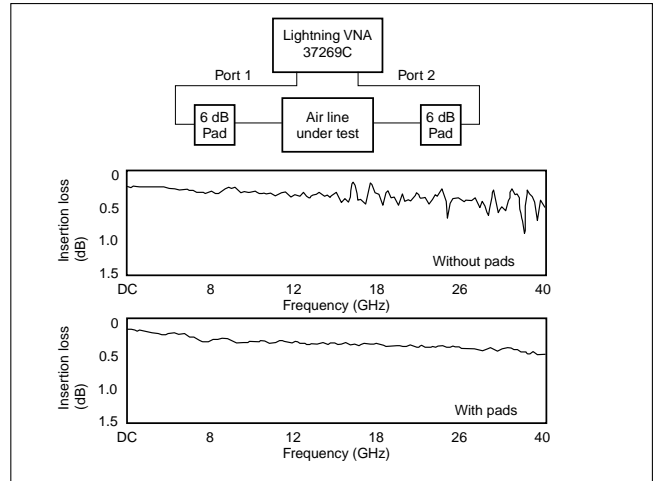
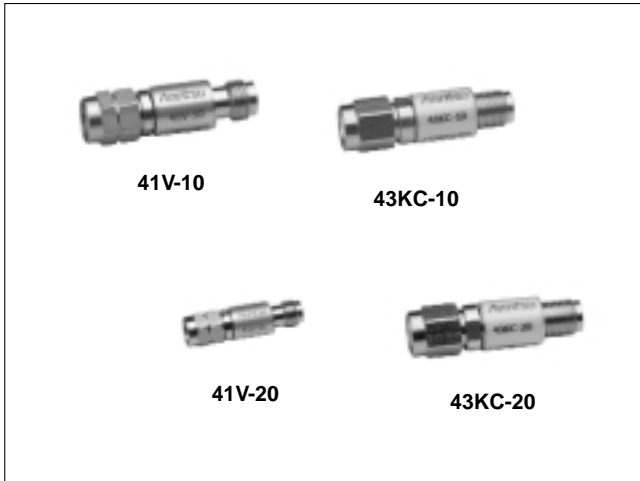

Improved Measured Accuracy

Anritsu offers two series of fixed attenuators:

- The Gold Line (Series 41) for precision measurement applications covering DC to 60 GHz
- The Silver Line (Series 43) for use in systems and OEM equipment covering DC to 40 GHz

Both series offer fixed attenuation values of 3, 6, 10, or 20 dB with models that span frequency range of DC to 26.5 GHz, 40 GHz, or 60 GHz.

Features

- 3, 6, 10, or 20 dB Attenuation up to 60 GHz
- Low SWR, 1.28 Up to 40 GHz
- SMA, 3.5 mm, and 2.4 mm compatibility
- Rugged and reliable K Connector® and V Connector®

Advanced performance and reliability

Anritsu attenuators define the standard for fixed attenuator performance and reliability. Performance, however, is not their only distinguishing feature. Attenuators that use the K Connector® offer a vast improvement in reliability. Attenuators that use the V Connector® can be connected directly to 2.4 mm devices.

For applications in metrology and calibration laboratories where precise characterization is essential, the Gold Line models are available in sets consisting of 3, 6, 10, and 20 dB units. Each is provided with attenuation and SWR calibration data. Calibration data is also optionally available for individual units, each of which is serialized.

The reliability of the attenuator connectors is affected by insertion force, outer conductor mating area, and mating alignment. The K Connector® is used because it has excellent performance in all of

these areas. For example, a typical female SMA, 3.5 mm center conductor requires up to 27N* of insertion force compared to 2.2N* for the K Connector®. In addition, the K Connector® outer conductor is four times thicker than SMA, resulting in a conservative order-of-magnitude improvement in the number of reliable connections.

To avoid a major cause of connector failure, the K Connector® male pin is deliberately made shorter than the SMA pin. Therefore, the outer housing is properly aligned prior to center conductor mating, preventing destructive misalignment.

Gold Line - improved measurement accuracy

Adding Gold Line attenuators to your attenuation measurement setup will improve your measurement accuracy. In the test setup shown, the insertion loss of an air line was measured, first without and then with matching 6 dB pads. The difference in the accuracy of the two measurements is striking. By attenuating reflections and re-reflections that occur at the input and output of the air line, the pads reduce mismatch errors and allow the system to measure more accurately the actual insertion loss.

Silver Line - improved system reliability

Fixed attenuators used in systems or OEM equipment must be small, lightweight, economical, and reliable under severe environmental conditions. The Silver Line meets these requirements. K Connectors ensure well-seated, low-reflection connections that provide consistent operation year after year.

The Series 43 (Silver Line) attenuator's small size, 8 mm dia. x 28.8 mm length, and light weight, 8 g make them an attractive choice for miniaturized, lightweight systems.

* Force is measured in Newtons (N).

Common specifications

Impedance	50 Ω	
Power rating (average)	2W at 20°C; 1W at 85°C	
Temperature coefficient	0.001 dB/dB/°C	
Connectors	V Connector®	Male and female compatible with 2.4 mm
	K Connector®	Male and female, compatible with SMA and 3.5 mm
Material	Passivated stainless steel housing	
Size	Length	28.8 mm ±0.5 mm
	Diameter	8 mm
Weight	8 g	
Temperature range	Operating	-55°C to +85°C
	Nonoperating	-55°C to +125°C

Specifications

	Model*1	Attenuation (dB)	Attenuation Accuracy				SWR				
			DC-18 GHz	18-26.5 GHz	26.5-40 GHz	40-60 GHz	DC-12 GHz	12-18 GHz	18-26.5 GHz	26.5-40 GHz	40-60 GHz
Gold Line	DC to 60 GHz										
	41V-3	3	±0.5	±0.6	±0.9	±1.20	1.15	1.20	1.30	1.50	1.90
	41V-6	6	±0.5	±0.6	±0.9	±1.20	1.15	1.20	1.25	1.40	1.70
	41V-10	10	±0.5	±0.6	±0.9	±1.20	1.15	1.20	1.25	1.40	1.70
	41V-20	20	±0.5	±0.6	±0.9	±1.20	1.15	1.20	1.25	1.40	1.70
	DC to 40 GHz										
	41KC-3	3	±0.4	±0.5	±0.8	-	1.10	1.15	1.23	1.42	-
	41KC-6	6	±0.4	±0.5	±0.8	-	1.10	1.15	1.18	1.28	-
	41KC-10	10	±0.4	±0.5	±0.8	-	1.10	1.15	1.18	1.28	-
	41KC-20	20	±0.4	±0.5	±0.8	-	1.10	1.15	1.18	1.28	-
	DC to 26.5 GHz										
	41KB-3	3	±0.4	±0.5	-	-	1.10	1.15	1.23	-	-
41KB-6	6	±0.4	±0.5	-	-	1.10	1.15	1.18	-	-	
41KB-10	10	±0.4	±0.5	-	-	1.10	1.15	1.18	-	-	
41KB-20	20	±0.4	±0.5	-	-	1.10	1.15	1.18	-	-	
Silver Line	Model		Attenuation Accuracy				SWR				
		Attenuation² (dB)	DC-18 GHz	18-26.5 GHz	26.5-40 GHz	40-60 GHz	DC-12 GHz	12-18 GHz	18-26.5 GHz	26.5-40 GHz	40-60 GHz
	DC to 40 GHz										
	43KC-3	3	±0.5	±0.6	±0.9	-	1.15	1.20	1.30	1.50	-
	43KC-6	6	±0.5	±0.6	±0.9	-	1.15	1.20	1.30	1.40	-
	43KC-10	10	±0.5	±0.6	±0.9	-	1.15	1.20	1.30	1.40	-
	43KC-20	20	±0.5	±0.6	±0.9	-	1.15	1.20	1.30	1.40	-
	DC to 26.5 GHz										
	43KB-3	3	±0.5	±0.6	-	-	1.15	1.20	1.30	-	-
	43KB-6	6	±0.5	±0.6	-	-	1.15	1.20	1.30	-	-
	43KB-10	10	±0.5	±0.6	-	-	1.15	1.20	1.30	-	-
	43KB-20	20	±0.5	±0.6	-	-	1.15	1.20	1.30	-	-

*1: For traceability, all Gold Line attenuators are serialized.

*2: ±1 dB from DC to 26.5 GHz; ±1.3 dB from >26.5 to 40 GHz, including frequency response and DC offset.

Ordering information

Please specify model/order number, name, and quantity when ordering. Single fixed attenuators may be ordered from the table above.

Model/Order No.	Name
41KB-3, 6, 10, or 20	Precision Fixed Attenuator 3 dB, DC to 26.5 GHz, 50 Ω, K(m)-K(f)
41KC-3, 6, 10, or 20	
41V-3, 6, 10, or 20	
41KB-S*1	Precision Fixed Attenuator Set 41KB Series 41KC Series 41V Series
41KC-S*1	
41V-S*1	
43KB-3, 6, 10, or 20	Fixed Attenuator 3 dB, DC to 26.5 GHz, 50 Ω, K(m)-K(f)
43KC-3, 6, 10, or 20	
Option C*2	Option Calibration Data

*1: A set of 3, 6, 10, and 20 dB Gold line (Series 41). Attenuators are supplied in a handsome hardwood case. Calibration data are included for each unit.

*2: Attenuation and SWR test data are provided for input and output ports at 500 MHz frequency intervals.

STEP ATTENUATORS

4400, 4500, 4600 Series

DC to 40 GHz



4612K



4622K

Anritsu programmable step attenuators bring a substantial increase in the frequency and attenuation range available in one small package. Using the latest technology, these units offer superior performance, reliability, and ease of use to 40 GHz. All are plug-compatible with competitive units.

Features

- DC-20 GHz, DC-26.5 GHz, DC-40 GHz
- 70 dB and 110 dB attenuation ranges
- Lowest insertion loss
- Precise repeatability
- Life of 5 million operations
- Small, rugged, light weight

Advanced technology-advanced performance

Anritsu has lowered throughline loss by designing the first 40 dB attenuator sections to operate above 18 GHz. Compared with designs that use 30 dB sections, these attenuators have a shorter thru path and fewer switching contacts. As a result, insertion loss is as much as 1.7 dB less than that of units made by other companies. RF input power requirements for systems that use these attenuators can be reduced, saving money, space, and weight.

Integrated switching structure

The push rods that switch in the attenuator modules and thru-lines are driven by a solenoid actuator. By designing the solenoid as an integral part of the attenuator assembly, switching speeds of 20 ms (in-

cluding settling time) are achieved. Upon completion of the switching operation, the solenoid is magnetically latched to withstand severe shock and vibration. At the same time, the solenoid current is automatically turned off to save power and to minimize temperature rise. Also integrated in the design is solid state dc switching circuitry that avoids the relatively high failure rate of mechanical DC switches. Each attenuator section is controlled by its own driver circuit, which requires 24 V, 125 mA. A typical external driver circuit for one section is shown in the figure below.

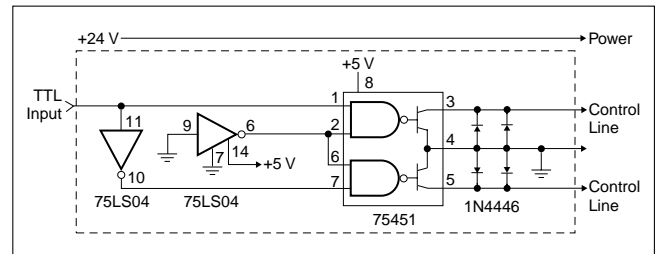

Accuracy enhancing calibration data

Attenuation accuracy can be improved by using optional calibration data taken on an Anritsu vector network analyzer. The calibration data can be used to normalize the effect of frequency response and reflections. The calibration data is traceable to NIST.

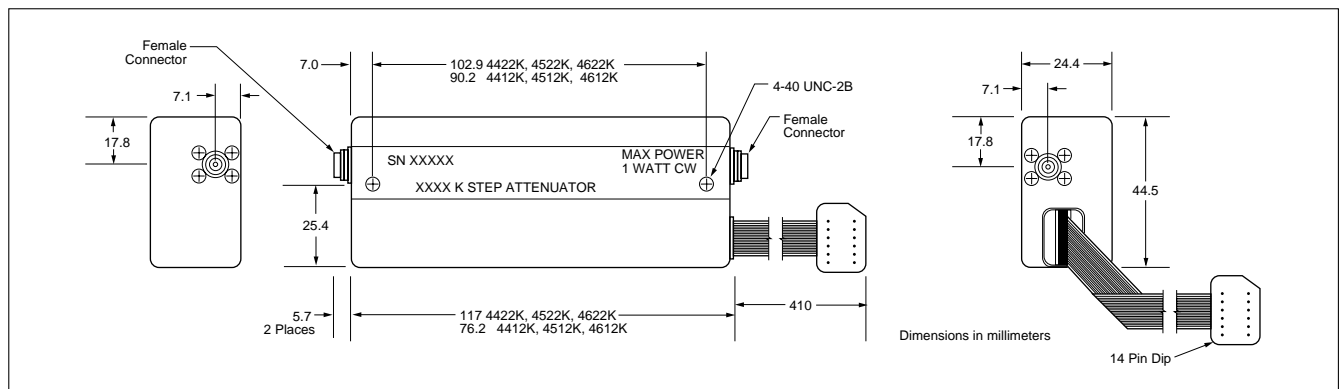

4400, 4500, and 4600 series outline

Specifications

Frequency and attenuation ranges

Model	Frequency range	Attenuation range in 10 dB steps	Connectors
4412K 4422K	DC to 20 GHz	0 to 70 dB 0 to 110 dB	K(f)
4512K 4522K	DC to 26.5 GHz	0 to 70 dB 0 to 110 dB	K(f)
4612K 4622K	DC to 40 GHz	0 to 70 dB 0 to 110 dB	K(f)

Attenuator accuracy (\pm dB)

Frequency (GHz)	Attenuation (dB)							
	10	20	30	40	50	60	70	80-110
DC to 8	0.3	0.5	0.6	0.7	0.8	1.0	1.1	1.4
>8 to 12	0.4	0.5	0.7	0.9	1.0	1.3	1.5	2.0
>12 to 20	0.5	0.6	0.8	1.1	1.2	1.4	1.7	2.2
>20 to 26.5	0.7	0.8	1.0	1.5	1.6	1.9	2.3	2.8
>26.5 to 40	0.9	1.0	1.2	1.7	1.9	2.3	2.6	3.2

Electrical

Switching speed (maximum)	20 ms
Operating voltage	20 to 30 Volts
Switching control current	125 mA at 24 V nominal per section 3 sections in 4412K, 4512K, 4612K 4 sections in 4422K, 4522K, 4622K
Solenoid coil impedance	190 Ω
Solenoid coil inductance	65 mH
RF input power (maximum)	1 W average, 100 W peak for 10 μ s
RF power sensitivity	0.001 dB/W
Life (minimum operations per section)	5 million
Repeatability (typical after 1 million operations)	\pm 0.03 dB to 18 GHz \pm 0.05 dB to 26.5 GHz \pm 0.08 dB to 40 GHz \pm 0.20 dB to 60 GHz

Insertion loss (maximum)

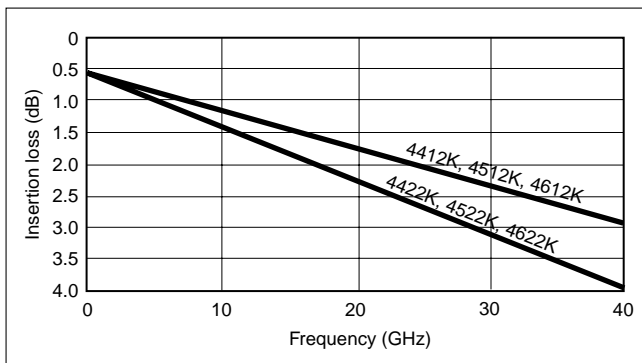

Impedance match

Frequency (GHz)	Return loss (dB)	SWR
DC to 8	19	1.25
>8 to 12	14	1.5
>12 to 20	12.7	1.6
>20 to 26.5	11	1.8
>26.5 to 40	9	2.1

Mechanical

Weight	4412K, 4512K, 4612K: 170g 4422K, 4522K, 4622K: 213g
Mounting position	Any
RF connectors	K Connectors, female, in-line
Programming connector	14 pin DIP
Programming cable length	406 mm

Environment

Temperature	Operating:	0°C to +70°C
	Non-operating:	-55°C to +85°C
Altitude	Operating:	4.6 km (440 mm Hg)
	Non-operating:	15 km
Shock	Operating:	10 g, 6 ms, on 6 sides, 3 blows
	Non-operating:	500 g, 1.8 ms, in 6 directions
Humidity		0 to 95% relative humidity
EMC		Mil-Std-461, Method RE02, VDE 0871, CISPR#2

Ordering information

Please specify model/order number, name, and quantity when ordering.

Model/Order No.	Name
4412K	Step Attenuator, DC to 20 GHz, 70 dB
4512K	Step Attenuator, DC to 26.5 GHz, 70 dB
4612K	Step Attenuator, DC to 40 GHz, 70 dB
4422K	Step Attenuator, DC to 20 GHz, 110 dB
4522K	Step Attenuator, DC to 26.5 GHz, 110 dB
4622K	Step Attenuator, DC to 40 GHz, 110 dB
Option C*	Options Calibration Data (4412K, 4512K, 4612K)

* Calibration data is taken every 100 MHz from DC to 900 MHz and every 500 MHz from 1 GHz to 40 GHz.

SWR BRIDGES
87 Series
 2 to 18 GHz



Specifications

Model	Directivity (dB)	Accuracy*1		
		2 to 3 GHz	3 to 4 GHz	4 to 18 GHz
87A50	35	0.018 +0.32ρ ²	0.018 +0.23ρ ²	0.018 +0.015ρ ²
87A50-1	38	0.013 +0.32ρ ²	0.013 +0.23ρ ²	0.013 +0.015ρ ²

Frequency range	2 to 18 GHz
Insertion loss	6.5 dB nominal*2
Maximum input power	0.5 W
Test port connector	GPC-7
Input and output connector	Type N(f)
Dimensions	7.3 x 5.2 x 2.9 cm plus connectors
Weight	340 g

*1: Where ρ is the measured reflection coefficient.

*2: Typically 9 dB at 18 GHz from input to test port.

The 87 Series SWR Bridges are precision, high directivity measurement components, ideal for SWR and return loss measurements. Models include a built-in termination, and they are provided with an overall accuracy equation. These SWR bridges can be used for making very low-level SWR measurements by amplifying the RF output prior to detection. Since both the phase and amplitude of the reflected signal are preserved in the RF output, these components can also be used to make accurate phase comparisons in a network analyzer system.

Features

- Broadband 2 to 18 GHz frequency range
- High 38 dB directivity
- Precise GPC-7 test port connector
- Built-in reference termination

Ordering information

Please specify model/order number, name, and quantity when ordering.

Model/Order No.	Name
87A50	SWR Bridge, 2 to 18 GHz, GPC-7, 35 dB directivity
87A50-1	SWR Bridge, 2 to 18 GHz, GPC-7, 38 dB directivity

Temperature range: +25°C ±5°C

SWR AUTOTESTERS

97 Series and 560-97, 560-98 Series

10 MHz to 50 GHz



The Series 97, 560-97 and 560-98 SWR Autotesters integrate a high directivity bridge, a detector, a low reflection test port, and a precision reference termination. The 560-97 and -98 Series units are broadband microwave measurement components that are used with the Model 56100A Scalar Network Analyzer and with Series 54100A Scalar Measurement System for making fixed-frequency and swept-frequency return loss (SWR) measurements. Return loss measurements are used over a wide range of radio and microwave frequencies to check the performance of systems, subsystems, and microwave components such as amplifiers, directional couplers, attenuators, filters, splitters, and terminations.

560-97, 98 Series SWR autotester features

- Up to 40 dB directivity
- 10 MHz to 50 GHz range
- Test port connectors to fit most measurement applications; avoids use of adapters

97 Series SWR autotester features

- High 40 dB directivity
- Low test port reflections
- Broadband 10 MHz to 18 GHz frequency range
- Small package including bridges, termination, and detector
- Selection of GPC-7, WSMA, or Type N test port connectors

Specifications

Models	Directivity (dB)	Accuracy*1		Freq. Sensitivity (dB)	Test Port Connection	Physical
97 Series SWR Autotesters, 10 MHz to 18 GHz*2						
97A50	36	10 MHz-8 GHz 0.016 +0.06ρ ²	8-18 GHz 0.016 +0.10ρ ²	±1.5 max.	GPC-7	Dimensions: 7.6 x 5 x 2.8 cm plus connectors Weight: 340 g
97A50-1	40	0.010 +0.06ρ ²	0.010 +0.10ρ ²	±1.5 max.	GPC-7	
97N50 97NF50	35	0.018 +0.08ρ ²	0.018 +0.12ρ ²	±1.5 max.	Type N(m) Type N(f)	
97N50-1 97NF50-1	38	0.013 +0.08ρ ²	0.013 +0.12ρ ²	±1.5 max.	Type N(m) Type N(f)	
97S50 97SF50	35	0.018 +0.08ρ ²	0.018 +0.12ρ ²	±1.5 max.	WSMA(m) WSMA(f)	
97S50-1 97SF50-1	38	0.013 +0.08ρ ²	0.013 +0.12ρ ²	±1.5 max.	WSMA(m) WSMA(f)	
560-97 Series SWR Autotesters, 10 MHz to 18 GHz*2						
560-97A50	36	0.01-8 GHz 0.013 ±0.08ρ ²	8-18 GHz 0.016 ±0.10ρ ²	±1.2	GPC-7	Dimensions*5: 7.6 x 5.1 x 2.8 cm Weight: 340 g
560-97A50-1	40	0.010 ±0.06ρ ²	0.010 ±0.10ρ ²	±1.2	GPC-7	
560-97N50 560-97NF50	35	0.018 ±0.08ρ ²	0.018 ±0.12ρ ²	±1.5	Type N (m) Type N (f)	
560-97N50-1 560-97NF50-1	38	0.013 ±0.08ρ ²	0.013 ±0.12ρ ²	±1.5	Type N (m) Type N (f)	

Continued on next page

Models	Directivity (dB)	Accuracy*1				Freq. Sensitivity (dB)	Test Port Connection	Physical
560-98 Series SWR Autotesters, 10 MHz to 40 GHz*2								
560-98S50 560-98SF50	37 36	0.01-8 GHz	8-18 GHz 0.014 ±0.10p ²	18-26.5 GHz 0.016 ±0.13p ²	26.5-40 GHz	±2.0	WSMA (m) WSMA (f)	Dimensions*4: 1.9 x 3.8 x 2.9 cm Weight: 198 g
560-98S50-1 560-98SF50-1	40 38	0.010 ±0.07p ²	0.010 ±0.10p ²	0.013 ±0.13p ²		±2.0	WSMA (m) WSMA (f)	
560-98K50 560-98KF50	35 32 30	0.018 ±0.07p ²	0.018 ±0.07p ²	0.026 ±0.15p ²	0.032 ±0.18p ²	±3.0	Type K (m) Type K (f)	
560-98 Series SWR Autotesters, 10 MHz to 50 GHz*3								
560-98VA50 560-98VFA50	30	0.01-50 GHz 0.032 ±0.11p ²				±4.0	Type V (m) Type V (f)	Dimensions*4: 2.2 x 6.6 x 5.3 cm Weight: 198 g
560-97, 560-98 Offset SWR Autotesters, 10 MHz to 40 GHz								
560-97A50-20	20	500 MHz-18 GHz*5 0.0015				±2.5	GPC-7	Dimensions*4: 7.6 x 5.1 x 2.8 cm Weight: 340 g
560-98KF50-15	15	800 MHz-40 GHz*6 0.0100				±4.0	Type K (m)	Dimensions*4: 2.2 x 6.6 x 5.3 cm Weight: 198 g
All Models: Input Port Impedance: 50 Ω Detector Output Polarity: Negative Maximum Power Input: 0.5 W (+27 dBm) (560-98C50A: +24 dBm) Insertion Loss (from input to test port): 6.5 dB nominal Output Time Constant: 2 μs Cable Length: 122 cm (4 ft.)								

*1: Where r is the reflection coefficient being measured. Accuracy includes the effects of test port reflections and directivity.

*2: Input Connector: Ruggedized Type K Female

*3: Input Connector: Ruggedized Type V Female

*4: Plus connectors and cable

*5: When used with 18A50 Airline

*6: When used with 19K50 Airline

Temperature: +25°C ±5°C

Ordering information

Please specify model/order number, name, and quantity when ordering.

Model/Order No.	Name
	SWR Autotester
97A50	10 MHz to 18 GHz, GPC-7, 36 dB directivity
97A50-1	10 MHz to 18 GHz, GPC-7, 40 dB directivity
97N50	10 MHz to 18 GHz, N(m), 35 dB directivity
97N50-1	10 MHz to 18 GHz, N(m), 38 dB directivity
97NF50	10 MHz to 18 GHz, N(f), 35 dB directivity
97NF50-1	10 MHz to 18 GHz, N(f), 38 dB directivity
97S50	10 MHz to 18 GHz, WSMA(m), 35 dB directivity
97S50-1	10 MHz to 18 GHz, WSMA(m), 38 dB directivity
97SF50	10 MHz to 18 GHz, WSMA(f), 35 dB directivity
97SF50-1	10 MHz to 18 GHz, WSMA(f), 38 dB directivity
560-97A50	10 MHz-18.0 GHz, GPC-7, 50 Ω, 36 dB directivity
560-97A50-1	10 MHz-18 GHz, GPC-7, 50 Ω, 40 dB directivity
560-97N50	10 MHz-18 GHz, N(m), 50 Ω, 35 dB directivity
560-97N50-1	10 MHz-18 GHz, N(m), 50 Ω, 38 dB directivity
560-97NF50	10 MHz-18 GHz, N(f), 50 Ω, 35 dB directivity
560-97NF50-1	10 MHz-18 GHz, N(f), 50 Ω, 38 dB directivity
560-98S50	10 MHz-26.5 GHz, WSMA(m), 50 Ω, directivity = 37 dB (<18 GHz), 36 dB (18 GHz)
560-98S50-1	10 MHz-26.5 GHz, WSMA(m), 50 Ω, directivity = 40 dB (< 18 GHz), 38 dB (18 GHz)

Model/Order No.	Name
560-98SF50	10 MHz-26.5 GHz, WSMA(f), 50 Ω, directivity = 37 dB (< 18 GHz), 36 dB (18 GHz)
560-98SF50-1	10 MHz-26.5 GHz, WSMA(f), 50 Ω, directivity = 40 dB (< 18 GHz), 38 dB (18 GHz)
560-98K50	10 MHz-40 GHz, K(m), 50 Ω, directivity = 35 dB (<18 GHz), 32 dB (18 to 26.5 GHz), 30 dB (26.5 GHz)
560-98KF50	10 MHz-40 GHz, K(f), 50 Ω, directivity = 35 dB (<18 GHz), 32 dB (18 to 26.5 GHz), 30 dB (26.5 GHz)
560-98VA50	10 MHz-50 GHz, V(m), 50 Ω, directivity = 36 dB (<20 GHz), 30 dB (20 GHz)
560-98VFA50	10 MHz-50 GHz, V(f), 50 Ω, directivity = 36 dB (<20 GHz), 30 dB (20 GHz)
	Offset SWR Autotester
560-97A50-20	10 MHz to 18 GHz, GPC-7, 20 dB offset reference in bridge
560-98KF50-15	10 MHz to 40 GHz, K(f), 15 dB offset reference in bridge

SWR AUTOTESTERS 5400-6 Series 1 MHz to 3000 MHz

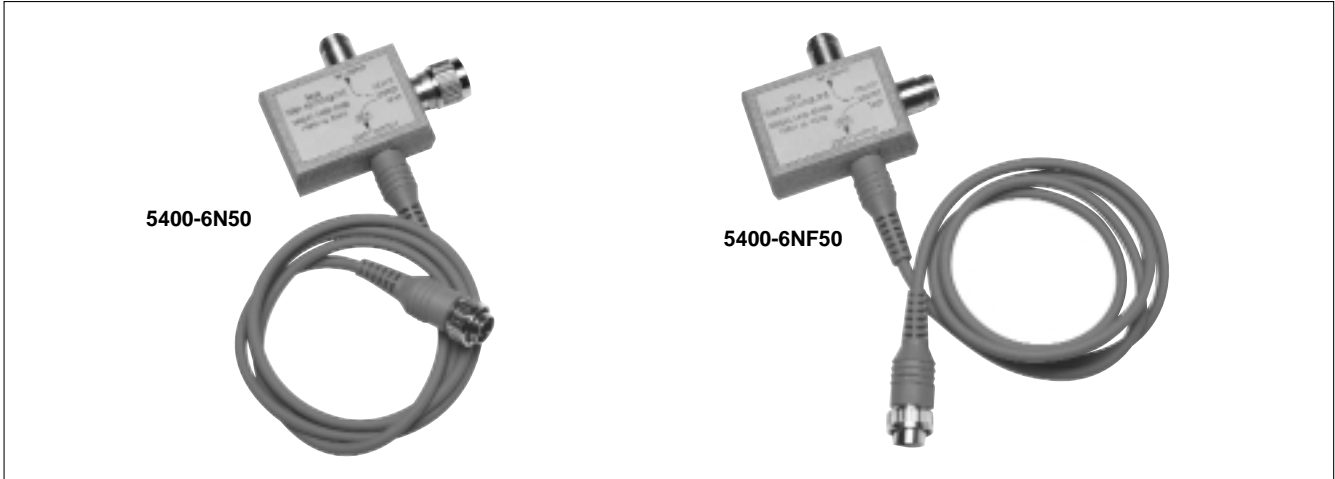

The 5400-6 Series SWR Autotesters integrate a high directivity bridge, a detector, a low reflection test port, a precision reference termination, and a connecting cable. They are used with the Model 56100A Scalar Network Analyzers and with Series 54100A Scalar Measurement Systems for making fixed-frequency and swept-frequency return loss (SWR) measurements. Return loss measurements are used over a wide range of radio and microwave frequen-

cies to check the performance of systems, subsystems, and microwave components such as amplifiers, directional couplers, attenuators, filters, splitters, and terminations.

Features

- 40 dB directivity.
- 1 MHz to 3000 MHz range
- F, N, or BNC type test port connectors

Specifications

Models	Directivity (dB)	Accuracy*1			Test Port Connection	Physical
5400-67FF75*2,5	40	10-1000 MHz 0.010 ±0.01p ²			F (f)	Dimensions*4: 2.5 x 5.1 x 7.0 cm Weight: 255 g
5400-6B50B*3 5400-6BF50B*3	40	1-1500 MHz 0.010 ±0.01p ²			BNC (m) BNC (f)	
5400-6B75B*3,5 5400-6BF75B*3,5	40	0.010 ±0.10p ²			BNC (m) BNC (f)	
5400-6N50*3 5400-6NF50*3	40	1-1000 MHz 0.010 ±0.05p ²	1000-3000 MHz 0.010 ±0.05p ²	2000-3000 MHz 0.010 ±0.05p ²	Type N (m) Type N (f)	
5400-6N75*3,5 5400-6NF75*3,5	40	0.010 ±0.05p ²	0.010 ±0.05p ²	0.010 ±0.08p ²	Type N (m) Type N (f)	
All Models: Input Port Impedance: 50 Ω (Except as Noted) Detector Output Polarity: Negative Maximum Power Input: 0.5 watts (+27 dBm) Insertion Loss (from input to test port): 6.5 dB nominal Output Time Constant: 2 μs Cable Length: 122 cm (4 ft.)						

*1: Where p is the reflection coefficient being measured. Accuracy includes the effects of test port reflections and directivity.

*2: Input Connector: BNC Femal

*3: Input Connector: Type N Female

*4: Plus connectors and cable

*5: Impedance 75 Ω

Temperature range: +25°C ±5°C

Ordering information

Please specify model/order number, name, and quantity when ordering.

Model/Order No.	Name
	SWR Autotester
5400-6N50	1 to 3000 MHz, Type N(m), 50 Ω 40 dB Directivity
5400-6N75	1 to 3000 MHz, Type N(m), 75 Ω
5400-6NF50	1 to 3000 MHz, Type N(f), 50 Ω
5400-6NF75	1 to 3000 MHz, Type N(f), 75 Ω

CONVERTIBLE SWR AUTOTESTER 560-98C50A and Test Port Heads

10 MHz to 40 GHz

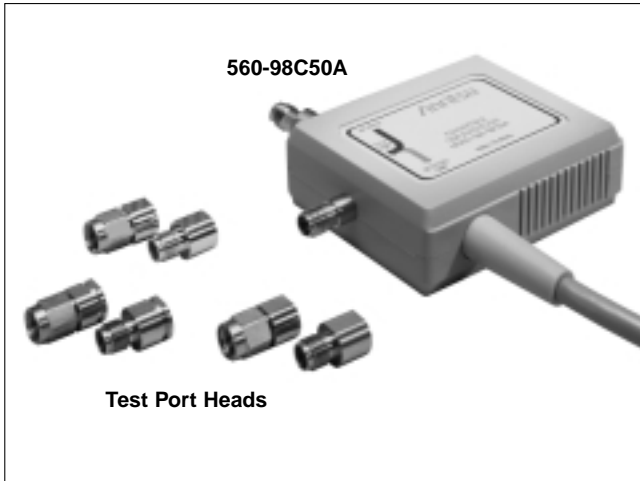

Convertible SWR Autotesters reduce capital equipment and maintenance costs. A single Convertible SWR Autotester accurately measures the Return Loss or SWR of devices with SMA, 3.5 mm, or K Connector®. Six interchangeable test port heads (male and female for each connector standard) are precision tuned to the Convertible SWR Autotester's internal bridge circuit.

The inexpensive test port heads save repair and calibration costs, because they are interchangeable. Repetitive connect/disconnect cycles will eventually wear out test port connectors — especially when excess torque is applied and the connector's mating surfaces are rotated against each other.

It is common practice today to avoid the subsequent maintenance cost by using adapters or "Connector Savers" on the test port of the directional device (RF Bridge, SWR Autotester, or Directional Coupler). Unfortunately, the adapters attached to a standard RF Bridge cause accuracy problems. Directional devices are tuned for optimum directivity at a specific phase reference point — this position is called the test port. Any test port adapter will degrade the effective directivity. The Convertible SWR Autotester's interchangeable test port heads eliminate the accuracy problem.

Adapter errors

In a standard RF bridge, measurement error increases when adapters or connector savers are used 1) to change the connector's sex and/or 2) to protect the test port from physical wear. The error effect is represented as a reduction to directivity. Effective Directivity is a measurement error term consisting of the directional device's directivity plus the SWR response of the test port adapter/connector saver.

Effective-Directivity is illustrated in the following illustration. The Directivity Error, E_d , is caused by deviations from ideal within the directional device. The adapter's SWR is represented by E_a . Both E_d and E_a cause errors in the measurement of DUT's return loss, E_x . This error problem is compounded by production practices which use poor quality adapters and neglect calibration/verification cycles.

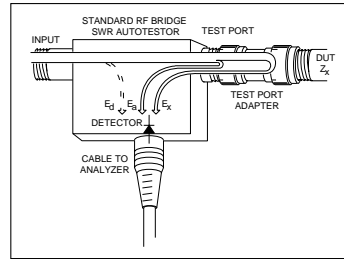

A test port adapter on a standard SWR Autotester or RF Bridge creates an error vector E_a in addition to directivity, E_d .

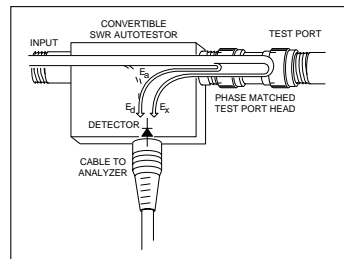

The directivity response of a Convertible SWR Autotester is tuned to cancel the vector reflection response of the phase matched test port heads.

Accuracy improvement

The Convertible SWR Autotester improves the accuracy of SMA device tests. It is common practice to test SMA devices with either 3.5 mm or K test ports. The 3.5 mm and K Connector® standards offer rugged, instrument grade connections, but they are not designed for proper impedance match to a device that has SMA connectors. SMA, K, and 3.5 mm connectors are mechanically compatible, but lack electrical compatibility. The resulting connector mismatch causes a 10 to 15 dB degradation in measurement directivity.

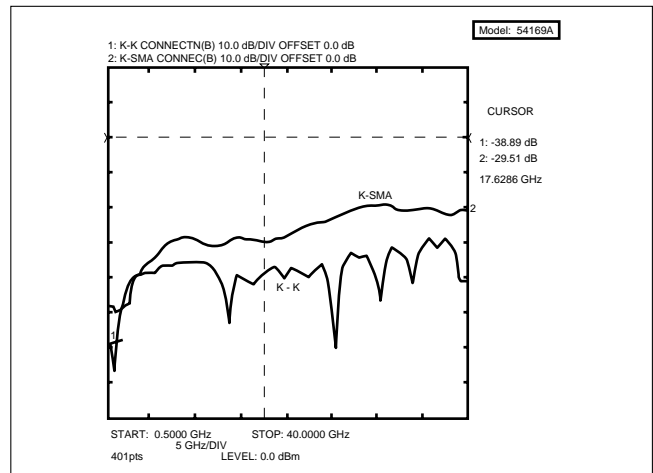

The Directivity of a K - K connector interface is far superior to a mismatched K - SMA connection

The above graph illustrates the degradation to directivity when a K Connector® test port is used to measure a precision SMA device. A 3.5 mm interface causes similar errors. The directivity was measured using the precision return loss mode on a 54100A Series Network Analyzer.

K - SMA or 3.5 mm - SMA interfaces.

Electrically, the Convertible SWR Autotester provides a nearly perfect 50 Ω interface when connected to SMA devices – resulting in a typical 10 dB improvement in effective directivity performance as compared to other SMA compatible connectors.

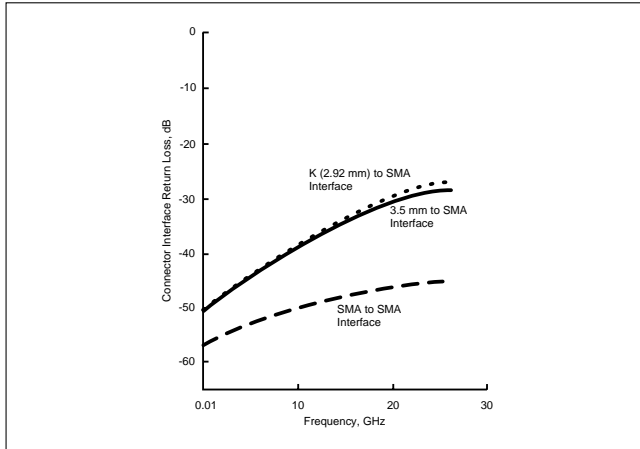

The Convertible SWR Autotester provides significantly better directivity performance than test components with either K (2.92 mm) or 3.5 mm test port connectors.

SMA connections to either K (2.92 mm) or 3.5 mm connectors are inherently capacitive. Both K and 3.5 mm connectors use air dielectric. The Teflon® or foam polyethylene dielectric common to SMA connectors have different dielectric constants than air. Thus, the coaxial dimensions of the center and outer conductors must also be different to maintain a 50 Ω transmission line impedance. Since the K and 3.5 mm connector standards specify flush pin depths, a non-50 Ω capacitance develops between their relatively thick outer conductors to the center pin of an SMA connected device.

Anritsu's 25S50 and 25SF50 SMA Test Port Heads include an inductive connection to SMA connectors by virtue of a slight air gap at the center pin interface. The air gap negates excess capacitance caused by the 50 Ω dimensional transition from the test port head's air dielectric to the SMA connector's Teflon® dielectric.

SMA connectors are not used as a precision instrumentation connector for three important reasons. First, the dielectric tends to expand and contract slightly with temperature and humidity conditions; thus, it is difficult to adhere to dimensional standards traceability (typically, precision air lines are used as primary or secondary reference standards) over a reasonable range of manufacturing floor conditions. Second, as an inexpensive connector type, many manufacturers have taken liberties in the specification of dimensions, tolerances, dielectric types and metallurgic content. A precision standard for SMA connector design is not recognized by the microwave industry. Finally, SMA designs suffer from reliability problems when subjected to multiple connections. Center pins can back out easily and the thin outer conductor wall is easily crushed when subjected to excessive torque.

The Convertible SWR Autotester solves these problems. Air dielectric is used to eliminate the temperature and humidity variations suffered by Teflon® and other dielectrics. Dimensional tolerances and metallic composition are clearly specified and center pin dimensions are phase matched. Air dielectric also allows use of thicker outer conductors, drastically decreasing potential deformation from excessive torque.

The Convertible SWR Autotester reduces maintenance costs without using error prone test port adapters or connector savers.

Accuracy for SMA device test is also improved because the test port head is properly compensated for operation with standard SMA connector dimensions.

Specifications

Frequency Range	0.01 to 40 GHz
Directivity	>34 dB 0.01 to 20 GHz >32 dB 20.0 to 26.5 GHz >29 dB 26.5 to 40.0 GHz
Test Port Match	>21 dB 0.01 to 20.0 GHz >18 dB 20.0 to 40.0 GHz
Maximum Input Power	+27 dBm
Source Input to Test Port Isolation	7.0 dB to 9.0 dB nominal insertion loss, frequency dependent.
Impedance	50 Ω
Input Connector	K(f), 2.92 mm with ruggedized threads
Compatibility	The 560-98C50 is compatible with the 560, 560A, 561, 5400A, 56100A, 562, 54100A and 54000A analyzers.
Dimensions	Autotester: 7.3 cm x 5.3 cm x 2.3 cm Test Port Heads: 16 mm(L) x 9 mm (dia.)

Temperature range: +25°C ±5°C

Ordering information

Please specify model/order number, name, and quantity when ordering.

Model/Order No.	Name
560-98C50A*	Convertible SWR Autotester
22K50	Open/Shorts Male Open/Short, (Included with 560-98C50A purchase.) Female Open/Short, (Not included with 560-98C50A purchase.)
22KF50	
25S50	Test Port Heads Precision Matched WSMA male Precision Matched WSMA female Precision Matched 3.5 mm male Precision Matched 3.5 mm female Precision Matched K male Precision Matched K female Precision Matched Set, WSMA male & female, K male & female Precision Matched Set, WSMA male & female, 3.5 mm male & female, K Connector male & female
25SF50	
25L50	
25LF50	
25K50	
25KF50	
25SKF50	
25SLF50	

* The Convertible SWR Autotester must be used with a test port head.

AIR LINES
18, 19 Series
 2 to 40 GHz

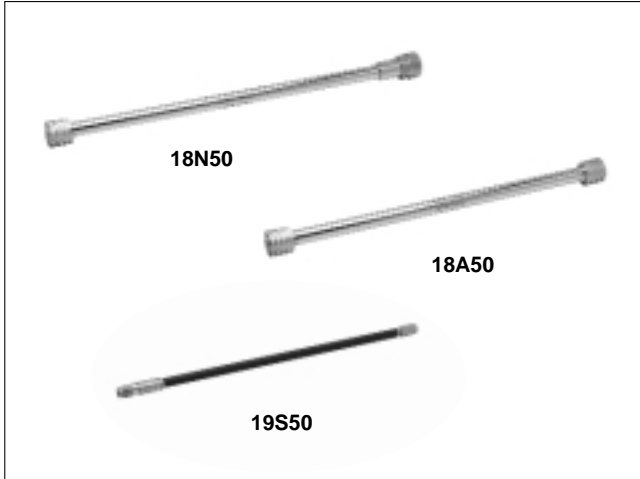

The 18 and 19 Series Precision Airlines are the most accurate impedance standards available today, and they are the recognized traceability path for impedance at high frequencies. Anritsu airlines are a critical component when measuring accurate impedances, enabling measurements down to 1.006 SWR to 18 GHz, 1.01 SWR to 26.5 GHz, and 1.02 SWR to 40 GHz.

A beadless connector is used at the measurement end to provide a minimum reflection connection. The other end is beaded to keep the center conductor captive, thus fixing the plane of reference at the beadless end.

Features

- Virtually lossless gold over silver plating
- Provide impedance traceability to NIST
- Enable measurements down to 1.006 SWR to 18 GHz, 1.01 SWR to 26.5 GHz, and 1.02 SWR to 40 GHz

Specifications

Model	Frequency range (GHz)	Test port connector	Beaded port connector	SWR (test port)	Dimensions L(cm) x dia(cm)
18A50	0.5 to 18	GPC-7	GPC-7	1.003	30 x 0.7
18N50 18NF50	0.5 to 18	N(m) N(f)	GPC-7	1.006	30 x 0.7
19S50 19SF50	0.8 to 26.5	WSMA(m) WSMA(f)	WSMA(m)	1.006 to 18 GHz 1.010 to 26.5 GHz	25 x 0.35
19K50 19KF50	0.8 to 40	K(m) K(f)	K(m)	1.020	15 x 0.29

Temperature range: +25°C ±5°C

Ordering information

Please specify model/order number, name, and quantity when ordering.

Model/Order No.	Name
	Precision Air Line
18A50	0.5 to 18 GHz, 50 Ω, GPC-7
18N50	0.5 to 18 GHz, 50 Ω, N (m)
18NF50	0.5 to 18 GHz, 50 Ω, N (f)
19K50	0.8 to 40 GHz, 50 Ω, K(m)
19KF50	0.8 to 40 GHz, 50 Ω, K(f)
19S50	0.8 to 26.5 GHz, 50 Ω, WSMA(m)
19SF50	0.8 to 26.5 GHz, 50 Ω, WSMA(f)

OPEN/SHORTS
22 Series
 DC to 50 GHz

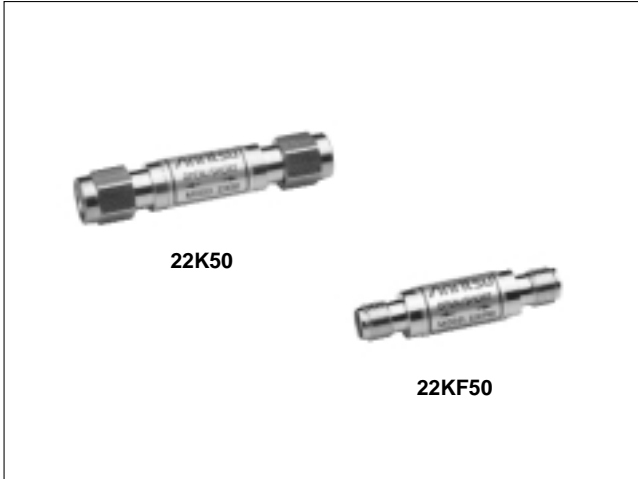

Specifications

Model	Frequency range (GHz)	Test port connector	Characteristic impedance (Ω)	Dimensions L(cm) x dia(cm)
22N75 22NF75	DC to 3	N(m) N(f)	75	6.3 x 1.8 4.9 x 1.6
22N50 22NF50	DC to 18	N(m) N(f)	50	6.3 x 1.8 4.9 x 1.6
22A50	DC to 18	GPC-7	50	3.8 x 1.6
22S50 22SF50	DC to 26.5	WSMA(m) WSMA(f)	50	4.2 x 0.8 3.5 x 0.8
22K50 22KF50	DC to 40	K(m) K(f)	50	4.2 x 0.8 3.5 x 0.8
22V50 22VF50	DC to 50	V(m) V(f)	50	3.6 x 0.8 2.8 x 0.8

Temperature range: +25°C ±5°C

The 22 Series Open/Shorts are used on the test port of an SWR Autotester or SWR bridge to establish a full reflection reference for accurate SWR measurements. When used with scalar network analyzers, the open and short reflections over a swept frequency range can be automatically averaged to enhance measurement accuracy. All models consist of an open on one end and a short on the other.

Features

- Single gold-plated component providing full open and short reflections for accurate SWR measurements
- DC to 50 GHz frequency coverage
- GPC-7, Type N, WSMA, K Connectors® and V Connectors®
- 50 Ω or 75 Ω impedance

Ordering information

Please specify model/order number, name, and quantity when ordering.

Model/Order No.	Name
	Open/Short
22N50	DC to 18 GHz, N(m), 50 Ω
22NF50	DC to 18 GHz, N(f), 50 Ω
22N75	DC to 3 GHz, N(m), 75 Ω
22NF75	DC to 3 GHz, N(f), 75 Ω
22A50	DC to 18 GHz, GPC-7 connector, 50 Ω
22K50	DC to 40 GHz, K(m), 50 Ω
22KF50	DC to 40 GHz, K(f), 50 Ω
22S50	DC to 26.5 GHz, WSMA(m), 50 Ω
22SF50	DC to 26.5 GHz, WSMA(f), 50 Ω
22V50	DC to 50 GHz, V(m), 50 Ω
22VF50	DC to 50 GHz, V(f), 50 Ω

OPEN/SHORTS/LOADS

OSL Series

DC to 4 GHz



Specifications

Model	Frequency range (GHz)	Test port connector	Characteristic impedance (Ω)
OSLN50LF	DC to 4	N(m)	50
OSLNF50LF	DC to 4	N(f)	50

Temperature range: +25°C \pm 5°C

Ordering information

Please specify model/order number, name, and quantity when ordering.

Model/Order No.	Name
OSLN50LF	Open/Short/Load DC to 4 GHz, N(m), 50 Ω
OSLNF50LF	DC to 4 GHz, N(f), 50 Ω

The OSL series open/short/load are used on the test port of hand held spectrum analyzer to establish a full reflection reference for accurate measurement. When used with HHS the open/short and load reflection over a swept frequency range can be automatically averaged to enhance measurement accuracy. OSL series Open/short/load comes in both N (Male) and N (Female) connector configuration and consist open on one end, short on other and Load on the tee section.

Features

- Single Nickel Plated Component providing full open, short and load reflections for accurate measurements.
- DC to 4 GHz frequency coverage
- Type N(Male) and N(Female) connector configurations
- 50 Ω Impedance

MICROWAVE DETECTORS

70, 75 Series

100 kHz to 50 GHz



Within the 70 or 75 Series product line, you will find a model that matches your needs for instrumentation, system, or OEM applications. By using the latest design and microelectronics production technologies, Anritsu low-barrier Schottky-diode detectors outperform others and offer significant cost savings. Input connector types include Type N, and K Connector® (compatible with SMA and 3.5 mm), and V Connector® (compatible with 2.4 mm). In addition to frequency coverage and price, these detectors are distinguished by their low SWR, flat frequency response, and close output-voltage tracking over a wide dynamic range.

Features

- Broadband coverage, 10 MHz to 50 GHz with a Single Detector
- K Connector® compatible with SMA and 3.5 mm
- V Connector® compatible with 2.4 mm
- Lowest SWR: 1.33 to 20 GHz, 1.5 to 40 GHz
- Flat Response: ±0.5 dB to 20 GHz ±1.5 dB to 40 GHz
- Best Value for Instrumentation, system, and OEM applications
- Low price and availability from stock

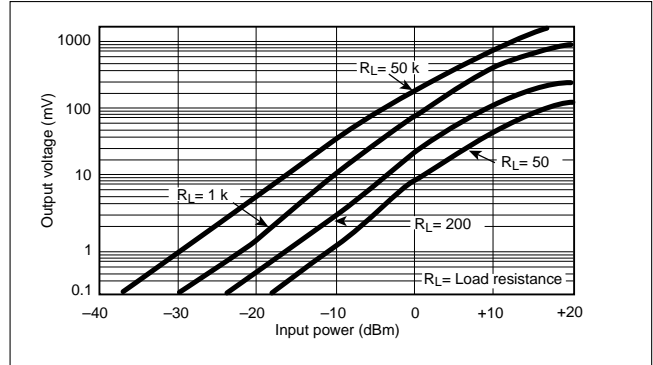

Typical sensitivity

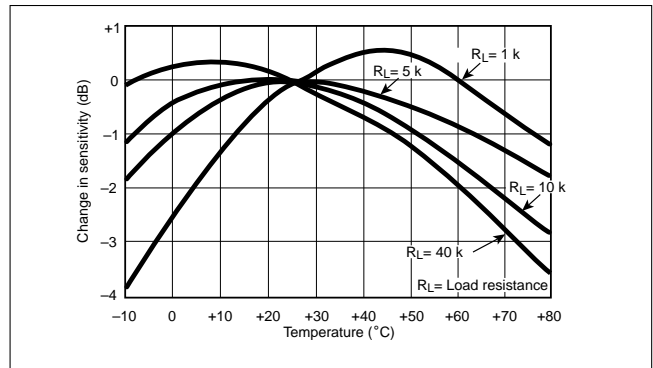

Typical sensitivity change

Specifications

Model	Frequency range	Flatness (dB)	Connectors		Impedance (Ω)	SWR (Maximum)	Low level sensitivity at -30 dBm (mV/μW)	High level sensitivity at +13 dBm (Volts, Min.)	Input maximum (mW)	Output capacitance (pF)
			In	Out						
70KA50	0.01 to 20 GHz	± 0.6	K(m)	SMC(f)	50	1.33	0.6	1	100	30
70KC50	0.01 to 40 GHz	± 0.5 to 20 GHz ± 1.0 to 26.5 GHz ± 1.5 to 40 GHz	K(m)	SMC(f)	50	1.33 to 20 GHz 1.50 to 26.5 GHz 1.90 to 40 GHz	0.4	1	100	30
75N50B	0.01 to 18 GHz	± 0.3 to 12.4 GHz ± 0.6 to 18 GHz	N(m)	BNC(f)	50	1.15 to 4.5 GHz 1.30 to 15 GHz 1.39 to 18 GHz	0.35	1	100	30
75KC50	0.01 to 40 GHz	± 0.5 to 20 GHz ± 1.0 to 26.5 GHz ± 1.5 to 40 GHz	K(m)	BNC(f)	50	1.33 to 20 GHz 1.50 to 26.5 GHz 1.90 to 40 GHz	0.4	1	100	30
75VA50	0.01 to 50 GHz	± 0.5 to 20 GHz ± 1.0 to 26.5 GHz ± 1.5 to 40 GHz ± 3 to 50 GHz	V(m)	BNC(f)	50	1.33 to 20 GHz 1.50 to 26.5 GHz 1.90 to 40 GHz 2.1 to 50 GHz	0.4	1	100	30

Dimensions

Model	Dimensions L(cm) x dia(cm)
70KA50	4.6 x 1.0
70KC50	4.6 x 1.0
75N50B	6.4 x 1.8
75KC50	4.6 x 1.0
75VA50	4.6 x 1.0

Ordering information

Please specify model/order number, name, and quantity when ordering.

Model/Order No.	Name
	Microwave Detector
70KA50	10 MHz to 20 GHz, K(m) input, SMC(m) output, 50 Ω
70KC50	10 MHz to 40 GHz, K(m) input, SMC(m) output, 50 Ω
75KC50	10 MHz to 40 GHz, K(m) input, BNC(f) output, 50 Ω
75N50B	10 MHz to 18.5 GHz, N(m) input, BNC(f) output, 50 Ω
75VA50	10 MHz to 50 GHz, V(m) input, BNC(f) output, 50 Ω
	Options
Option 2 (75KC50)	Matching frequency response of two detectors
Option 3 (75KC50)	Matching frequency response of three detectors

FIELD REPLACEABLE DIODE MODULES

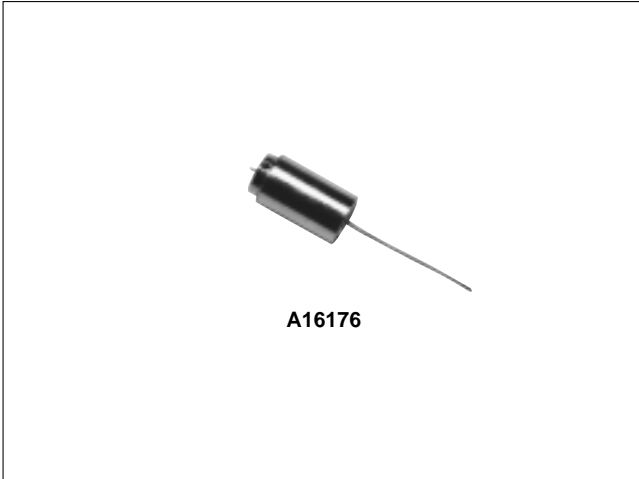

A16176

Field replaceable diode modules provide field replacements for damaged diodes, virtually eliminating down time. To avoid all degradation in performance when a diode is replaced in the field, all replacement modules include the thin-film matching circuit. Performance after replacement cannot be distinguished from that of a new detector.

Ordering information

Please specify model/order number, name, and quantity when ordering.

Model/Order No.	Name
	Diode module
10-108	71 & 73 Series
10-75	75A50
A16176	70K Series (≥ 20 GHz) and 75K Series (≥ 20 GHz)
A16177	70K Series (≤ 20 GHz) and 75K Series (≤ 20 GHz)
A18735	74N50B
B16132	75N50B

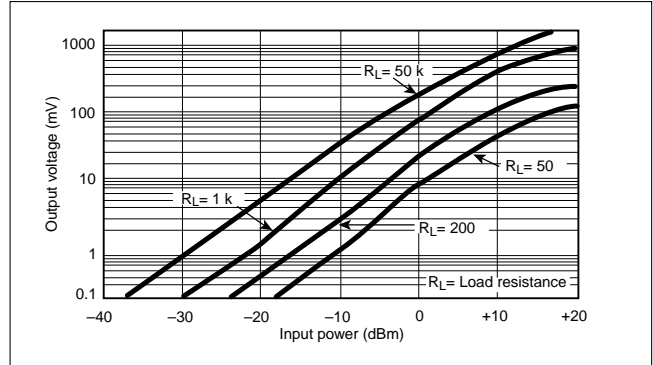

Typical sensitivity

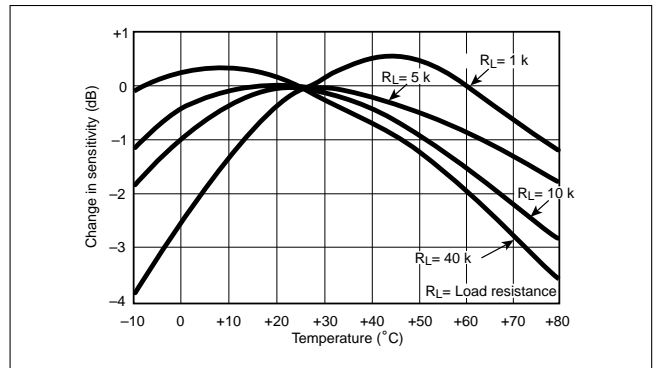

Typical sensitivity change

MICROWAVE DETECTORS

5400-71, 560-7 Series

1 MHz to 50 GHz



The Anritsu 560-7 and 5400-71 Series RF Detectors are used with the Model 56100A Scalar Network Analyzer and with Series 54100A Scalar Measurement System for making coaxial transmission loss or gain and power measurements. They are also used with the Site Master® and Cable Mate® Series Personal SWR/RL and Fault Location Testers for making power measurements.

Features

- Zero-biased Schottky diodes
- -55 dBm to +16 dBm range

Specifications

Model	Frequency range	Impedance	Return loss	Input connector	Frequency Response
560-7A50	0.01 to 18 GHz	50 Ω	15 dB, <0.04 GHz 22 dB, <8 GHz 17 dB, <18 GHz	GPC-7	±0.5 dB, 18 GHz
560-7N50B	0.01 to 20 GHz	50 Ω	15 dB, <0.04 GHz 22 dB, <8 GHz 17 dB, <18 GHz 14 dB, <20 GHz	N(m)	±0.5 dB, <18 GHz ±1.25 dB, <20 GHz
560-7S50B	0.01 to 20 GHz	50 Ω	15 dB, <0.04 GHz 22 dB, <8 GHz 17 dB, <18 GHz 14 dB, <20 GHz	WSMA(m)	±0.5 dB, <18 GHz ±1.25 dB, <20 GHz
560-7S50-2	0.01 to 26.5 GHz	50 Ω	15 dB, <0.04 GHz 22 dB, <8 GHz 17 dB, <18 GHz 14 dB, <26.5 GHz	WSMA(m)	±0.5 dB, <18 GHz ±1.25 dB, <26.5 GHz
560-7K50	0.01 to 40 GHz	50 Ω	12 dB, <0.04 GHz 22 dB, <8 GHz 7 dB, <18 GHz 15 dB, <26.5 GHz 14 dB, <32 GHz 13 dB, <40 GHz	K(m)	±0.5 dB, <18 GHz ±1.25 dB, <26.5 GHz ±2.2 dB, <32 GHz ±2.5 dB, <40 GHz
560-7VA50	0.01 to 50 GHz	50 Ω	12 dB, <0.04 GHz 19 dB, <20 GHz 15 dB, <40 GHz 10 dB, <50 GHz	V(m)	±0.8 dB, <20 GHz ±2.5 dB, <40 GHz ±3.0 dB, <50 GHz
5400-71B50	0.001 to 1.5 GHz	50 Ω	20 dB	BNC(m)	±0.2 dB, <1.5 GHz
5400-71B75	0.001 to 1.5 GHz	75 Ω	20 dB	BNC(m)	±0.2 dB, <1.5 GHz
5400-7N50	0.001 to 3 GHz	50 Ω	26 dB	N(m)	±0.2 dB, <1 GHz ±0.3 dB, <3 GHz
5400-71N75	0.001 to 3 GHz	75 Ω	26 dB, <2 GHz 20 dB, <3 GHz	N(m)	±0.2 dB, <3 GHz ±0.3 dB, <3 GHz
5400-71N75L*	0.005 to 1.2 GHz	75 Ω	24 dB	N(m)	±0.2 dB, <1 GHz ±0.5 dB, <1.2 GHz

* The input of the 5400-71N75L is limited to extend the damage level to 1 W (+30 dBm).
The limit begins compression at 10 dBm <0.05 GHz, 15 dBm <1 GHz, or 20 dBm <1.2 GHz.
Temperature range: 0°C to +70°C

Ordering information

Please specify model/order number, name, and quantity when ordering.

Model/Order No.	Name
5400-71N50	Microwave Detector
5400-71N75	N(m), 50 Ω, 1 to 3000 MHz
560-7A50	1 MHz to 3 GHz, N(m), 75 Ω
560-7A50	10 MHz to 18 GHz, GPC-7, 50 Ω
560-7K50	10 MHz to 40 GHz, K(m), 50 Ω

Model/Order No.	Name
560-7N50B	10 MHz to 20 GHz, N(m), 50 Ω
560-7S50-2	10 MHz to 26.5 GHz, WSMA(m), 50 Ω
560-7S50B	10 MHz to 20 GHz, WSMA(m), 50 Ω
560-7VA50	10 MHz to 50 GHz, V(m), 50 Ω

POWER SENSORS
MA2400A/B Series
 10 MHz to 50 GHz



The MA2400A/B Series Power Sensors consist of MA247XA Series Power Sensors, MA246XA/B Series Power Sensors, MA248XA Series Universal Power Sensors, MA242XA/B Series Thermal Power Sensors, and MA244XA Series High Accuracy Power Sensors. These units are broadband microwave measurement components. All models except the MA246XA/B Series Power Sensors, are used with the ML2430A Series Power Meters. The MA246XA/B Series Power Sensors are used only with the ML2400A Series Power Meter.

Features

- 10 MHz to 50 GHz range
- N, K, and V type RF connectors
- 90 dB dynamic range provides stable power readings to -70 dBm
- MA244XA Series High Accuracy Power Sensors contain an additional matching circuit to improve return loss performance
- MA242XA/B Series Thermal Power Sensors provide measuring speeds to 4 ms rise and fall times in addition to exceptional return loss performance
- MA246XB power sensors have fast 1 millisecond rise and fall times needed for CDMA measurements
- MA248XA Universal sensors measure average power of modulated signals such as W-CDMA, multi-tone, etc.
- All MA2400A/B Series Power Sensors contain internal EEPROMs for storage of calibration data as a function of frequency, power, and temperature. This allows the power meter to interpolate and correct readings automatically

Fast thermal sensors

Anritsu's thermal sensors provide excellent power measurement accuracy over 50 dB of dynamic range with more speed than any other thermal sensor available (see fig. 1). Thermal sensors use Seebeck elements where the combined effect of a thermal gradient and charge migration between dissimilar metals gives a true reading of average power on any incident waveform. Anritsu thermal sensors have class-leading SWR and built in EEPROM with calibration factor

and linearity correction data. This results in assured accuracy when measuring any signal. Anritsu's fast thermal power sensors improve sensor rise time and fall time to less than 4.0ms— an order of magnitude faster than previous thermal sensors. Settled power measurements are now 10 times faster; that means reduced test time.

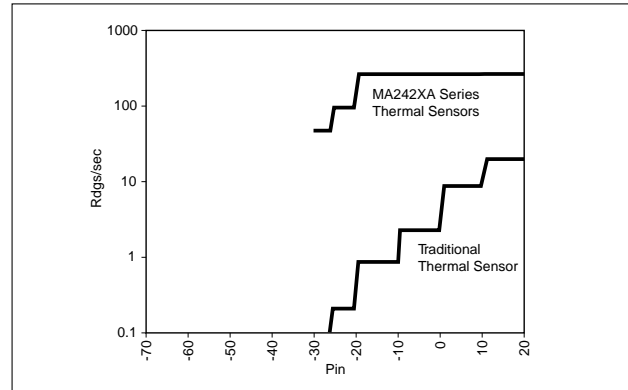

Fig. 1 Fast Thermal Sensors

Standard diode sensors

Diode sensors have greater speed, sensitivity and dynamic range than thermal sensors (see fig. 2). All Anritsu diode sensors use a dual diode architecture that gives improved sensitivity and dynamic range over single diode architectures. The MA2470A Series Power Sensors 90 dB dynamic range is both fast and accurate. Linearity is better than 1.8%, typically < 1.0% through 18 GHz.

MA2470A power sensors offer an ideal combination of speed and dynamic range for general purpose power measurements. A single sensor replaces the two sensors that were previously required with sensors limited to 50 dB dynamic range.

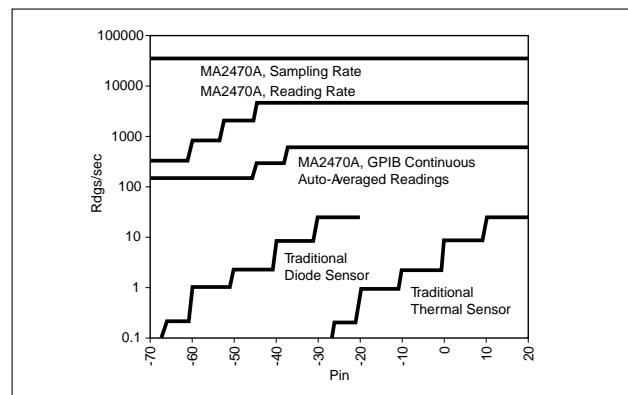

Fig. 2 Standard Diode Sensors

High accuracy diode sensors

The Anritsu MA2440A series high-accuracy diode sensors have a built in 3 dB attenuator to minimize input SWR. They are used where the best measurement accuracy is required over a large dynamic range, for example when measuring amplifiers. High accuracy diode sensors have a dynamic range of 87 dB compared to the 90 dB of standard diode sensors.

Fast diode sensors

The MA2460A fast diode sensors from Anritsu have a rise time of 0.6 μ s. This, together with a sensor video bandwidth of 1.25 MHz, makes them the ideal solution for power measurements on N-CDMA (IS-95) signals. The MA2460 sensors must be used with the ML2407/08A power meter. This combination of meter and sensor provides fast signal processing and sampling speeds. Average power, peak power and crest factor on N-CDMA signals can be measured and displayed. The MA2460 are dual diode sensors that deliver a greater-than 80 dB dynamic range, which makes them suitable for both open- and closed-loop power-control testing. The sensors internal AC detection circuitry gives a guaranteed noise floor of -60 dBm with typical performance to -70 dBm, even when measuring CDMA signals.

Pulses down to 1 μ s can also be captured and displayed, thanks to the sensor rise time of 0.6 μ s. In profile mode the ML2407A meter can be used to measure average power across narrow pulses, an increasingly common test method for amplifiers in digitally modulated systems.

Universal power sensors

The new MA2480A series Universal Power Sensors will measure any modulated or multi-tone signal, thanks to a patented sensor architecture with three diode pairs (see fig. 3). Universal power sensors deliver over 80 dB of dynamic range with speed and accuracy. Average power measurements on WCDMA signals can now be made without the need for special power meters. Universal sensors are also ideal for power measurements on other digitally modulated carriers such as HDTV, DAB or QAM modulated radio links.

Universal power sensors are also ideal for applications where multiple signals are present, such as intermodulation measurements and satellite multi carrier power loading measurements.

Anritsu universal power sensors have a unique additional capability for performing as a standard diode sensor for CW measurements. In this mode the fast response of diode sensors is maintained across the full dynamic range of the sensor, meaning that for the majority of users it is the only sensor that they will ever need – a truly Universal Power Sensor.

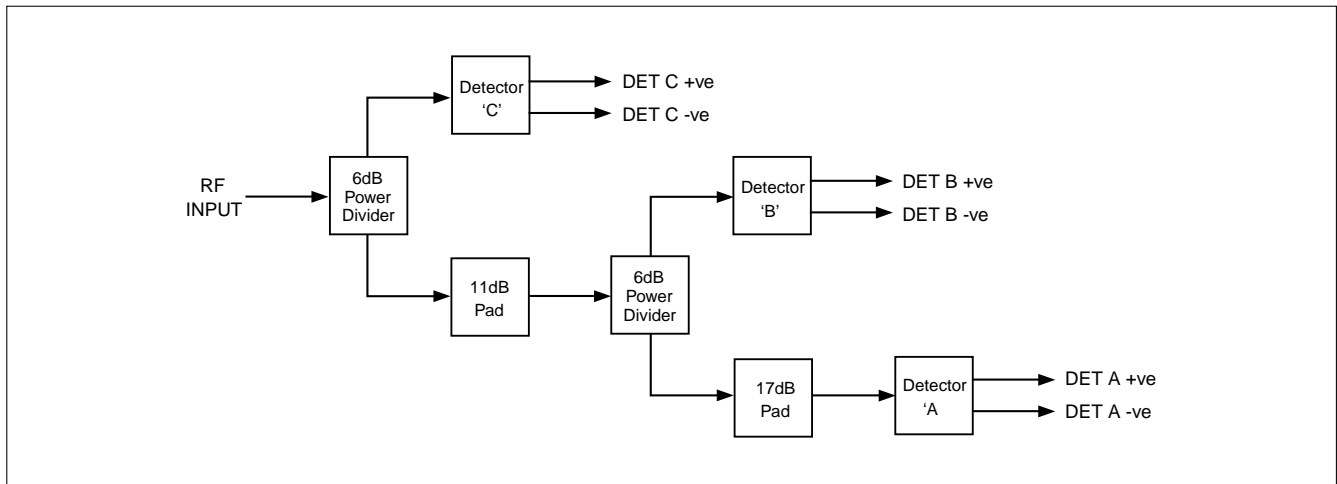

Fig. 3 Universal Power Sensor

Specifications

Model	Frequency range	Dynamic range (dBm)	SWR	Rise time*1 (ms)	Sensor linearity	RF connector*2
Standard diode sensors						
MA2472B	10 MHz - 18 GHz	-70 to +20	<1.17; 10 - 150 MHz (MA2472B only) <1.90; 10 - 50 MHz <1.17; 50 - 150 MHz <1.12; 0.15 - 2 GHz <1.22; 2 - 12.4 GHz <1.25; 12.4 - 18 GHz <1.35; 18 - 32 GHz <1.50; 32 - 40 GHz <1.63; 40 - 50 GHz	<0.004	1.8%, <18 GHz 2.5%, <40 GHz 3.5%, <50 GHz	N (m)
MA2473A	10 MHz - 32 GHz					K (m)
MA2474A	10 MHz - 40 GHz					K (m)
MA2475A	10 MHz - 50 GHz					V (m)
Fast thermal sensors						
MA2421B	0.1 MHz - 18 GHz	-30 to +20	<1.10; 0.1 MHz - 2 GHz <1.15; 2 - 12.4 GHz <1.20; 12.4 - 18 GHz <1.90; 10 - 50 MHz <1.17; 50 - 150 MHz <1.10; 0.15 - 2 GHz <1.15; 2 - 12.4 GHz <1.20; 12.4 - 18 GHz <1.25; 18 - 32 GHz <1.30; 32 - 40 GHz <1.40; 40 - 50 GHz	<4.0	1.3%, <18 GHz 1.5%, <40 GHz 1.8%, <50 GHz	N (m)
MA2422B	10 MHz - 18 GHz					N (m)
MA2423B	10 MHz - 32 GHz					K (m)
MA2424B	10 MHz - 40 GHz					K (m)
MA2425B	10 MHz - 50 GHz					V (m)
High accuracy diode sensors						
MA2442B	10 MHz - 18 GHz	-67 to +20	<1.17; 10 -150 MHz (MA2442B only) <1.90; 10 - 50 MHz <1.17; 50 - 150 MHz <1.08; 0.15 - 2 GHz <1.16; 2 - 12.4 GHz <1.21; 12.4 - 18 GHz <1.29; 18 - 32 GHz <1.44; 32 - 40 GHz <1.50; 40 - 50 GHz	<0.004	1.8%, <18 GHz 2.5%, <40 GHz 3.5%, <50 GHz	N (m)
MA2444A	10 MHz - 40 GHz					K (m)
MA2445A	10 MHz - 50 GHz					V (m)
Fast diode sensors						
MA2468A*3	10 MHz - 6 GHz	-60 to +20	<1.90; 10 - 50 MHz <1.17; 50 - 150 MHz <1.12; 0.15 - 2 GHz <1.22; 2 - 12.4 GHz <1.25; 12.4 - 18 GHz	<0.0006	1.8%	N (m)
MA2469B*3	10 MHz - 18 GHz					
Universal power sensors						
MA2481B	10 MHz - 6 GHz	-60 to +20	< 1.17; 10 - 150 MHz < 1.12; 0.15 - 2 GHz < 1.22; 2 - 12.4 GHz < 1.25; 12.4 - 18 GHz	<0.004 (with option 1 only)	10 MHz to 6GHz 3% -60 to +20 dBm 6 to 18 GHz 3% -60 to 0 dBm 3.5% 0 to +20 dBm (1.8% CW with option 1)	N (m)
MA2482A	10 MHz - 18 GHz					
MA2480/01	Adds fast CW mode to Universal Power Sensors for high speed measurements of CW signal plus TDMA and pulse measurements.					

*1: 0.0 dBm, room temperature.

*2: Each MA2400A/B series sensor incorporates precision RF connectors with hexagon coupling nut for attachment by industry standard torque wrench.

*3: MA2460A/B Fast Diode Sensors must be used with ML2407/08A Power Meters for NCDMA and Fast Pulse measurements.

Temperature range: +25°C ±5°C

Ordering information

Please specify model/order number, name, and quantity when ordering.

Model/Order No.	Name
MA2421A	Thermal Sensor 0.1 MHz to 18 GHz
MA2422B	
MA2423B	
MA2424B	
MA2425B	
MA2442A	High Accuracy Sensor 10 MHz to 18 GHz
MA2444A	
MA2445A	
MA2468A	Fast Diode Sensor 10 MHz to 6 GHz
MA2469B	

Model/Order No.	Name
MA2472A	Power Sensor 10 MHz to 18 GHz
MA2473A	
MA2474A	
MA2475A	
MA2481B	
MA2482A	
MA2480/01	
MA2400/98	
MA2400/99	
MA2497A	
MA2499B	

POWER DIVIDERS

11 Series

DC to 3000 MHz



These RF power dividers are symmetrical, three-resistor tee designs that can be used in applications where signals from DC to 3000 MHz must be accurately divided. They are available in 50 Ω or 75 Ω and provide excellent amplitude and phase tracking.

Features

- DC to 3000 MHz frequency range
- Excellent amplitude and phase tracking
- 50 or 75 Ω

Specifications

Model	Frequency range (MHz)	SWR	Insertion loss (dB, max.)	Impedance (Ω)	Connectors	
					Input	Output
11N50B	DC to 3000	<1.25	7	50	N(f)	N(f)
11N75B				75		

Maximum Input Power: 1 Watt
 Temperature range: 0°C to +70°C

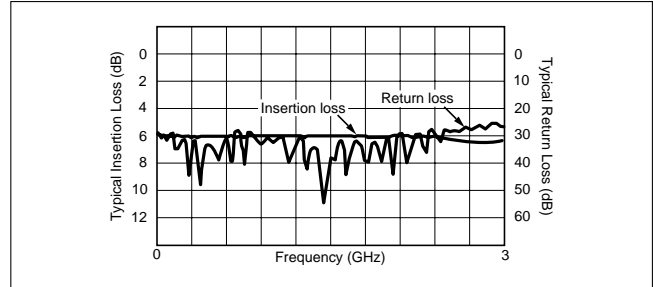

Insertion loss (typical) /return loss (typical)

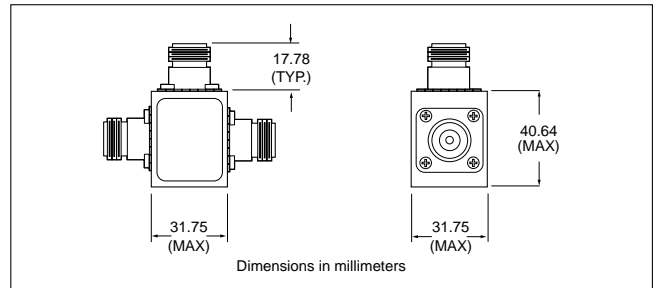

11N50B, 11N75B outline

Ordering information

Please specify model/order number, name, and quantity when ordering.

Model/Order No.	Name
11N50B	Power Divider, 1 MHz to 3 GHz
11N75B	Power Divider, 1 MHz to 3 GHz

POWER DIVIDERS K240, V240 Series DC to 65 GHz



V240C

These microwave power dividers are symmetrical, three-resistor tee designs that can be used in applications where signals from DC to 65 GHz must be accurately divided or combined. K Connector® is compatible with 3.5 mm and SMA; V Connector® is compatible with 2.4 mm. All models have exceptional amplitude and phase tracking characteristics.

Features

- DC to 65 GHz frequency range
- K Connector® compatibility with SMA/3.5 mm
- V Connector® compatibility with 2.4 mm
- Excellent amplitude and phase tracking

Specifications

Model	Frequency range (GHz)	Impedance (Ω)	Connectors	
			Input	Output
K240B	DC to 26.5	50	K(f)	K(f)
K240C	DC to 40	50	K(f)	K(f)
V240C	DC to 65	50	V(f)	V(f)

Frequency range (GHz)	Tracking of outputs		Insertion loss (dB max.)	SWR
	Amplitude	Phase		
DC to 6	± 0.3 dB	± 2°	7	1.22
6 to 18	± 0.3 dB	± 3°	7.5	1.44
18 to 26.5	± 0.6 dB	± 4°	8	1.58
26.5 to 40	± 0.6 dB	± 6°	8.5	1.79
40 to 65	± 1.8 dB	± 18°	10	3.11

Maximum Input Power: 1 W
Temperature range: 0°C to +70°C
Weight: 43 g

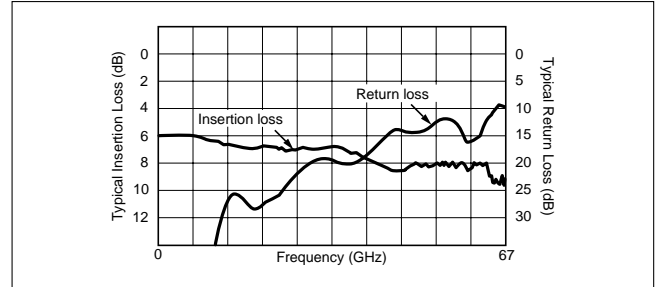

Insertion loss (typical) /return loss (typical)

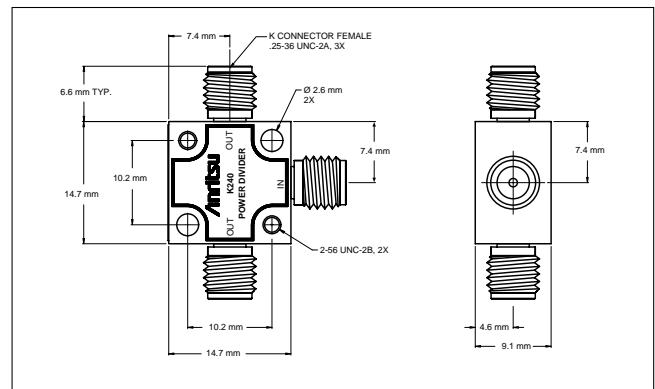

K240B, K240C outline

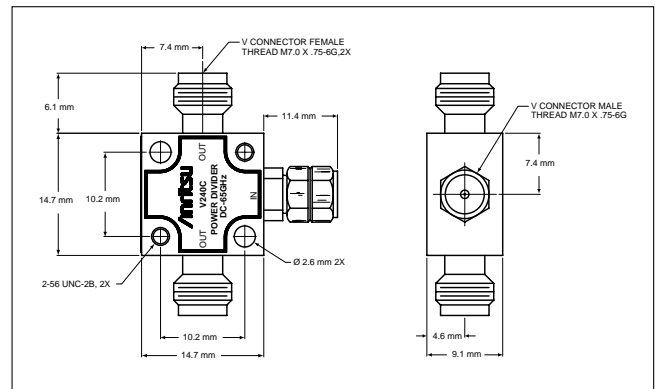

V240C outline

Ordering information

Please specify model/order number, name, and quantity when ordering.

Model/Order No.	Name
K240B	Precision Power Divider, DC to 26.5 GHz
K240C	Precision Power Divider, DC to 40 GHz
V240C	Precision Power Divider, DC to 60 GHz

POWER SPLITTERS
K241, V241 Series
 DC to 65 GHz

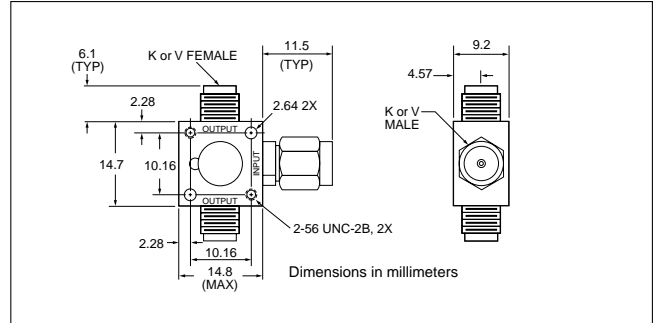

K241B, K241C Outline

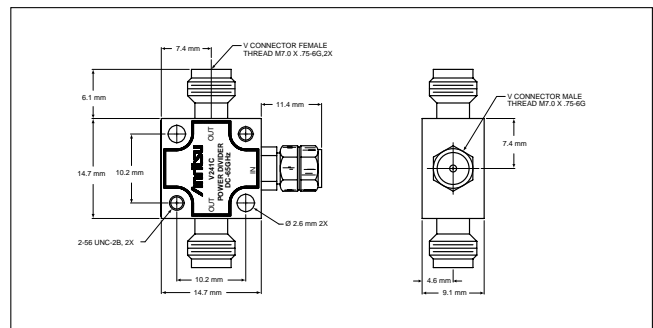

V241C Outline

These microwave power splitters are symmetrical, two-resistor designs that can be used in applications where signals from DC to 65 GHz must be accurately divided for ratio measurements. They provide excellent flatness and effective output SWR. K Connectors® are compatible with 3.5 mm and SMA; V Connectors® are compatible with 2.4 mm.

Features

- DC to 65 GHz frequency range
- K Connector® compatibility with SMA/3.5 mm
- V Connector® compatibility with 2.4 mm
- Excellent flatness and effective output SWR

Specifications

Model	Frequency range (GHz)	Impedance (Ω)	Connectors	
			Input	Output
K241B	DC to 26.5	50	K(m)	K(f)
K241C	DC to 40	50	K(m)	K(f)
V241C	DC to 65	50	V(m)	V(f)

Model	Frequency range (GHz)	Flatness (dB)	Input SWR	Effective output SWR	Insertion loss (dB)
K241B	DC to 26.5	2.0	1.45	1.45	7.5
K241C	DC to 26.5	2.0	1.45	1.45	7.5
	26.5 to 40	2.0	1.93	1.70	8.5
V241C	DC to 18	2.0	2.11	2.00	8.5
	18 to 40	2.0	2.33	2.30	9.5
	40 to 65	2.0	2.62	2.60	10.5

Maximum Input Power: 1 W
 Temperature range: 0°C to +70°C
 Weight: 43 g

Ordering information

Please specify model/order number, name, and quantity when ordering.

Model/Order No.	Name
K241B	Precision Power Splitter, DC to 26.5 GHz
K241C	Precision Power Splitter, DC to 40 GHz
V241C	Precision Power Splitter, DC to 60 GHz

POWER SPLITTERS

N241 Series

DC to 3000 MHz



N241A50

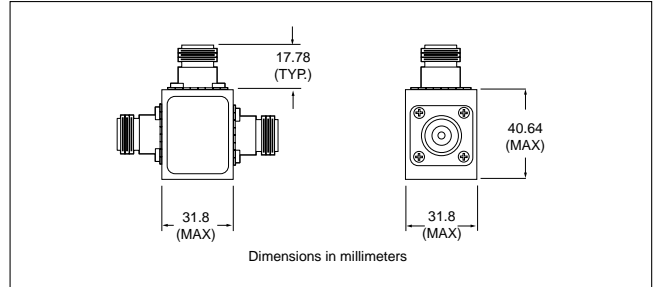

N241A50, N241A75 outline

Ordering information

Please specify model/order number, name, and quantity when ordering.

Model/Order No.	Name
N241A50	Power Splitter, DC to 3000 MHz
N241A75	Power Splitter, DC to 3000 MHz

These RF power splitters are symmetrical, two resistor designs that can be used in applications where signals from DC to 3000 MHz must be accurately divided for ratio measurements. They are available in 50 or 75 Ω and provide excellent flatness and effective output SWR.

Features

- DC to 3000 MHz frequency range
- Excellent flatness and effective output SWR
- 50 or 75 Ω

Specifications

Model	N241A50	N241A75
Frequency range	DC to 3000 MHz	DC to 3000 MHz
Input SWR	1.3	1.4
Effective output SWR	1.3	1.4
Insertion loss	7.5 dB	7.5 dB
Flatness	±1.5 dB	±1.5 dB
Impedance	50 Ω	75 Ω
Connectors	Input: N(f) Output: N(f)	Input: N(f) Output: N(f)

Maximum Input Power: 1 W
Temperature range: 0°C to +70°C

BIAS TEES

K250, V250

100 MHz to 40 GHz 100 MHz to 60 GHz



These bias tees are designed for applications where both DC and RF signals must be applied to a device under test. They are particularly suited for active device measurements. DC voltages of up to 30 volts at 0.5 amps may be applied to test devices with negligible effect on RF performance. Low RF throughline loss (<1 dB) and low return loss ensure negligible effect on measurements up to 60 GHz. An RF input DC block isolates the input port from the applied bias voltage.

Features

- Broadband, 0.1 to 60 GHz coverage
- Low SWR, low insertion loss
- K Connector® and V Connector® availability

Specifications

Model	K250	V250
Frequency range	0.1 to 40 GHz*1	0.1 to 60 GHz*1
Insertion loss	1.2 dB typ.	2.2 dB typ.
Return loss	15 dB min. to 20 GHz 10 dB min. to 40 GHz	13 dB min. to 20 GHz 9 dB min. to 40 GHz 8 dB min. to 60 GHz
RF power	1W max.	1 W max.
DC voltage	30V max.	30 V max.
DC current	0.5A	0.5 A
DC port isolation	20 dB at 0.1 GHz 40 dB above 0.5 GHz	20 dB at 0.1 GHz 40 dB above 0.5 GHz
RF connectors	Input: K(m) Output: K(f)	Input: V(m) Output: V(f)
DC connectors	SMC(m)	SMC(m)

*1. Usable between 0.04 and 0.1 GHz with degraded performance.

Temperature range: 0°C to +70°C

Specifications

Temperature	0 to 60°C
Mounting position	Any
Weight	57g

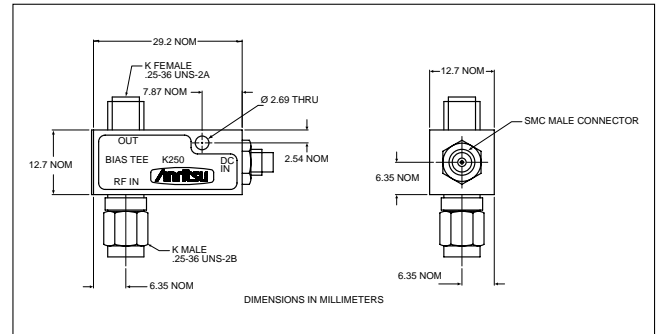

Outline drawing (K and V models)

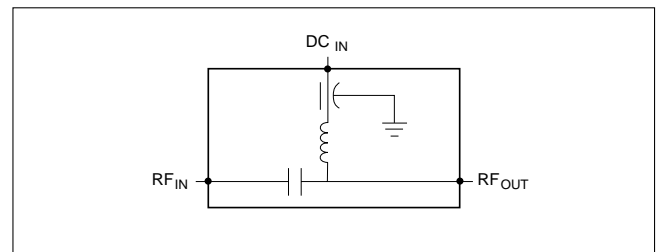

Schematic diagram (K and V models)

Ordering information

Please specify model/order number, name, and quantity when ordering.

Model/Order No.	Name
K250	Precision Bias Tee, 100 MHz to 40 GHz
V250	Precision Bias Tee, 100 MHz to 60 GHz

ULTRA-WIDEBAND BIAS TEES

K251, V251

50 kHz to 40 GHz 100 kHz to 65 GHz

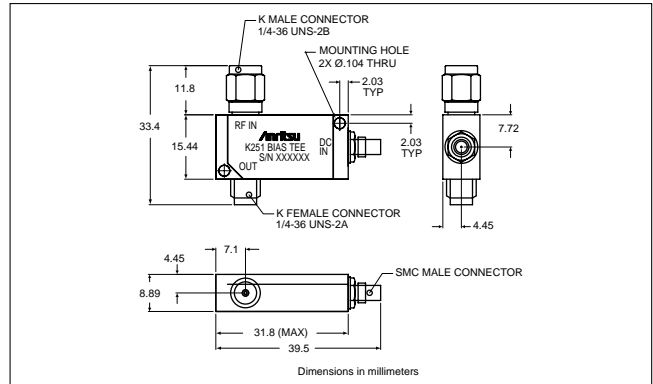
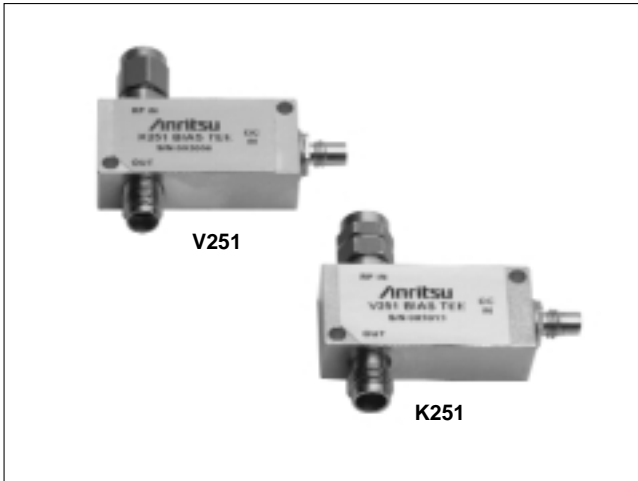

K251 outline drawing

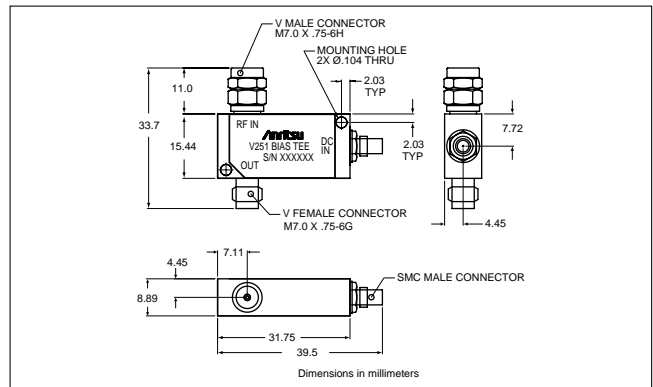

V251 outline drawing

These ultra-wide bandwidth bias tees have been optimized for optical communications and other high-speed pulse, data or microwave applications. Designed to simultaneously apply both DC and RF drive signals to a device via a single input port, these bias tees feature fast rise times, excellent low frequency response, minimum insertion loss and flat group delay. Precision K Connector® and V Connector® interfaces assure excellent impedance match across the wide bandwidths available. A one year warranty is provided.

Features

- Ideal for Optical Communications Applications
- Low Insertion Loss
- Risetime: <5 ps (V251), <7 ps (K251)

Specifications

Model	Frequency range	Insertion loss	Return loss	Rise time	Group delay	Max DC current	Max DC voltage	Max RF power	Connectors
K251	50 kHz to 40 GHz	<2 dB typical	See Plot	<7 ps typical	110 ±2 ps typical	100 mA	16 VDC	1 W	RF In: K(m) RF Out: K(f) Bias: SMC(m)
V251	100 kHz to 65 GHz	<2.5 dB typical	See Plot	<5 ps typical	113 ±2 ps typical	100 mA	16 VDC	1 W	RF In: V(m) RF Out: V(f) Bias: SMC(m)

Specifications apply over the full DC Bias current range and over the temperature range of 0°C to +70°C.

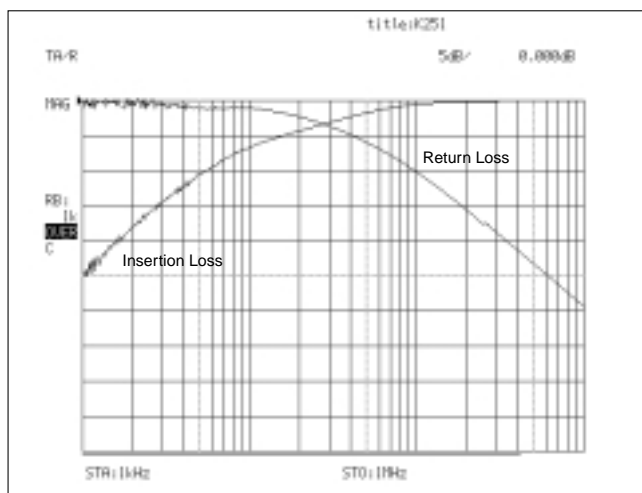

Typical Low Frequency Insertion Loss and Return Loss measured on K251 over the range of 1 kHz to 1 MHz.

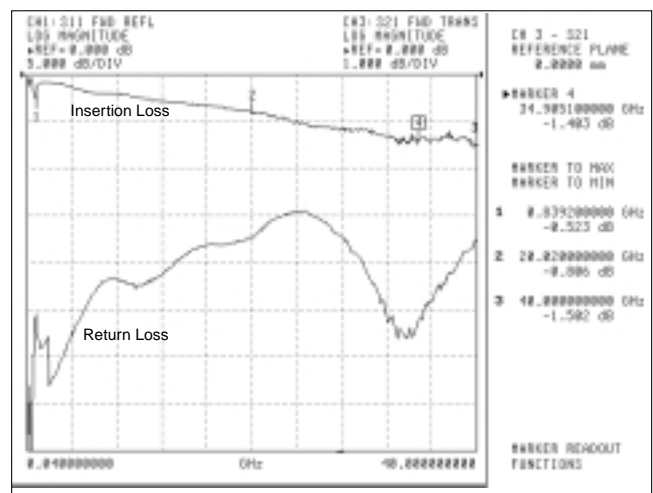

Typical Insertion Loss and Return Loss measured on K251 over the range of 40 MHz to 40 GHz.

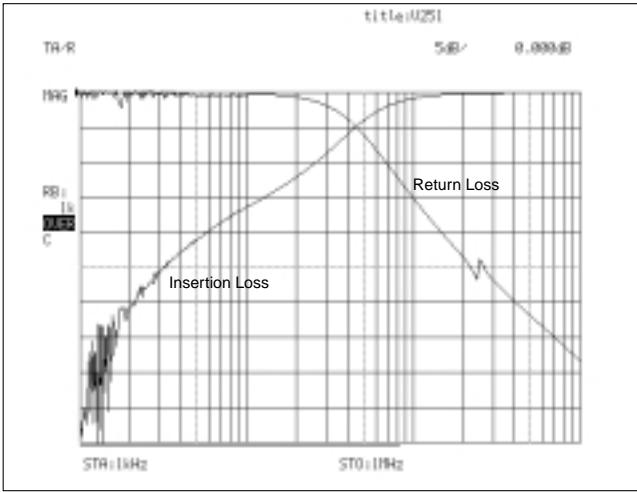

Typical Low Frequency Insertion Loss measured on V251 over the range of 1 kHz to 1 MHz.

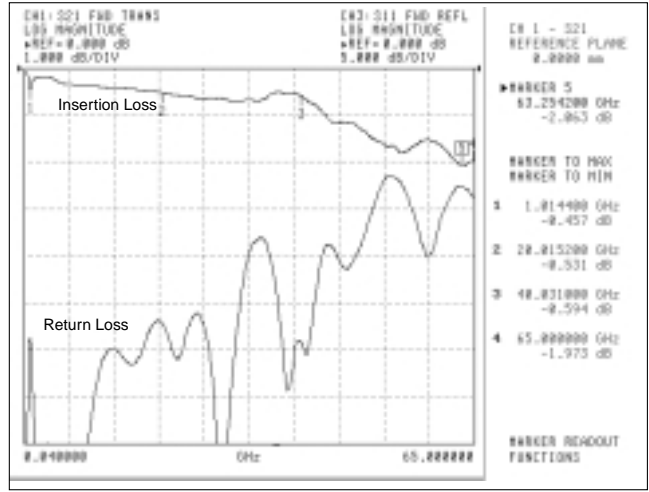

Insertion Loss and Return Loss measured on V251 over the range of 40 MHz to 65 GHz.

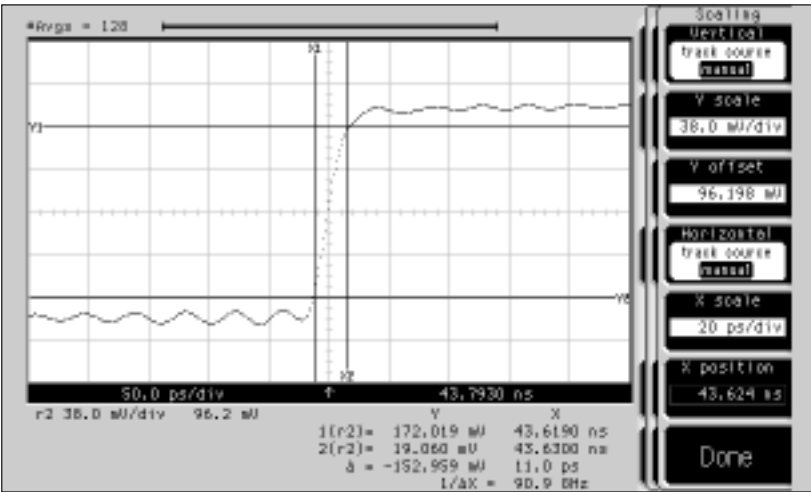

Typical Uncorrected Pulse Response for V251. Absolute risetime for the Bias Tee is derived from this measured data by applying the RSS method to compensate for the risetime of the input pulse.

$$\sqrt{T_{BT}^2 + T_{PG}^2} = T_{meas.}$$

$T_{meas.}$ = uncorrected risetime
 T_{BT} = absolute Bias Tee risetime
 T_{PG} = risetime of input pulse

$$T_{BT} = \sqrt{T_{meas}^2 - T_{PG}^2}$$

Ordering information

Please specify model/order number, name, and quantity when ordering.

Model/Order No.	Name
K251	Precision Bias Tee, 50 kHz to 40 GHz
V251	Precision Bias Tee, 100 kHz to 65 GHz

ULTRA-WIDEBAND BIAS TEE, HIGH CURRENT
V255
 50 kHz to 65 GHz

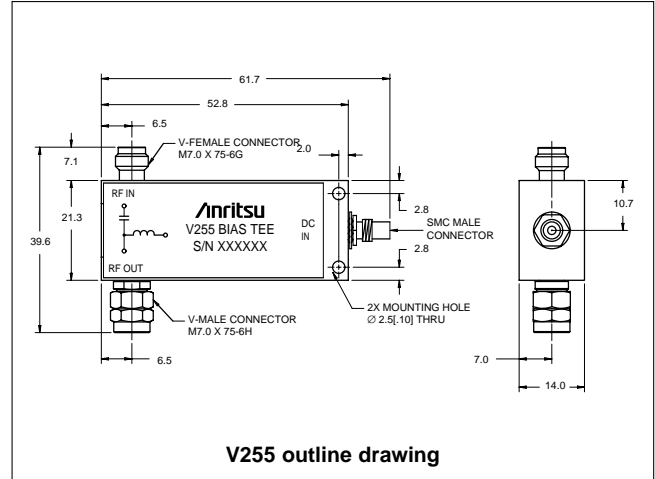

The V255 Gen II Ultra Wideband Bias Tee is designed to meet the high electrical performance requirement of passive components in optical communication networks. Given a broader bandwidth of 50 kHz to 65 GHz, with low insertion losses and very good return loss, makes it ideal to use in 40 Gbps systems to bias optical modulators and broad band data drivers. It's fast rise time and flat group delay performance allows extremely accurate measurements within a laboratory environment. The V255 Bias Tee comes with a standard V Connector® that assures excellent impedance match across the available wide bandwidth. The DC signal can be applied or extracted from the bias tee through an SMC connector at the third port. As with our other bias tees, the V255 also has a one-year warranty.

Features

- Ideal for Optical Communication applications.
- Very low Insertion Loss
- Rise Time 3 ps typical
- High Current Capacity
- High Isolation between Input Port and DC Port

Specifications

Model	Frequency range	Insertion loss	Return loss	DC voltage	DC current	Isolation	Rise Time	Group delay	Operating temp.
V255	50 kHz to 65 GHz 30 kHz to 65 GHz typ.	1.5 dB to 65 GHz typ.	12 dB to 65 GHz typ.	10 V max.	400 mA max.	-50 dBm min.	3 ps typ.	125 ±2 ps typ.	0°C to 80°C

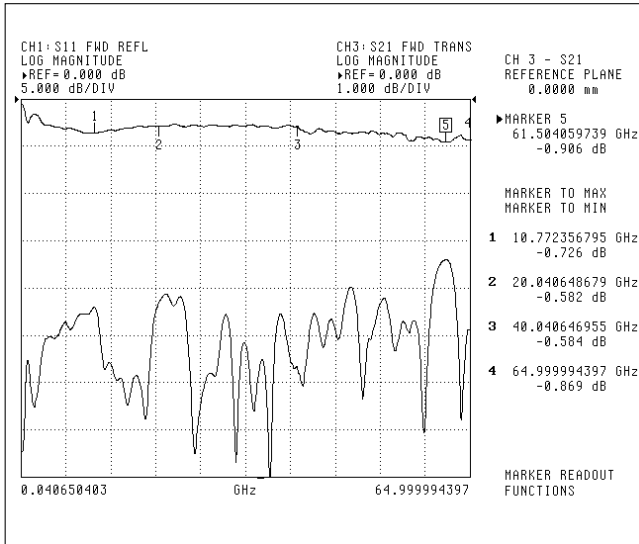

Typical High Frequency Insertion Loss and Return Loss measured on V255 over the range of 40 MHz

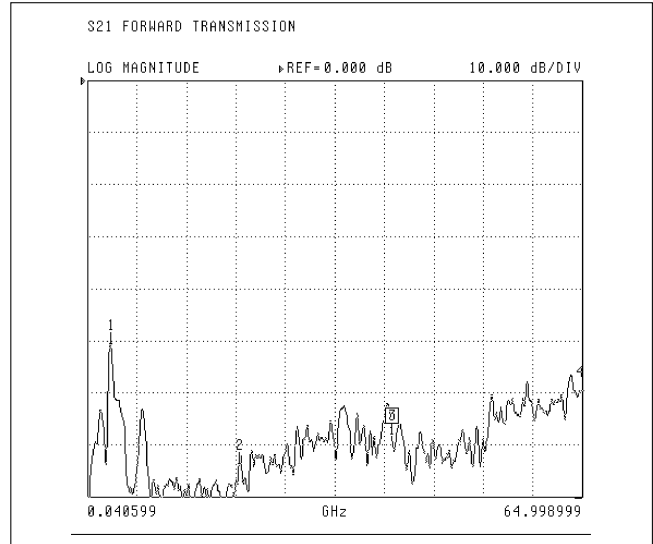

Typical Isolation between Data I/P and DC Port

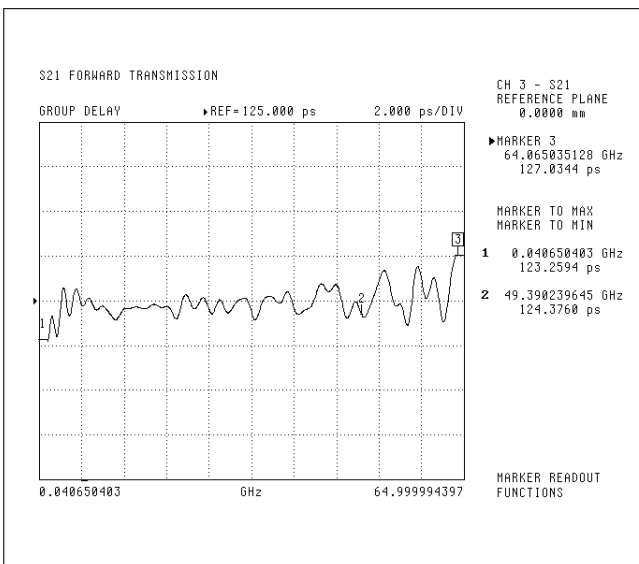

Typical Group Delay Performance measured on V255

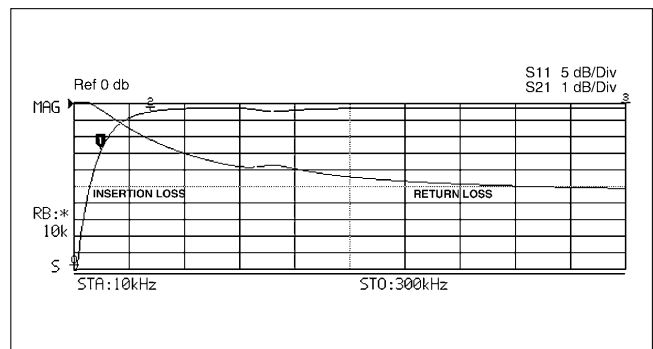

Typical Low Frequency Insertion Loss and Return Loss measured on V255 Bias Tee over the range of 10 kHz to 300 kHz

Ordering information

Please specify model/order number, name, and quantity when ordering.

Model/Order No.	Name
V255	Gen II Wideband Bias Tee, 50 kHz to 65 GHz

PRECISION DC BLOCKS

K261, V261

10 kHz to 40 GHz 50 kHz to 65 GHz

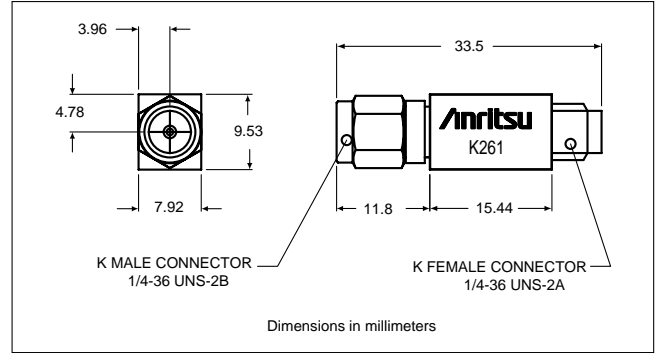
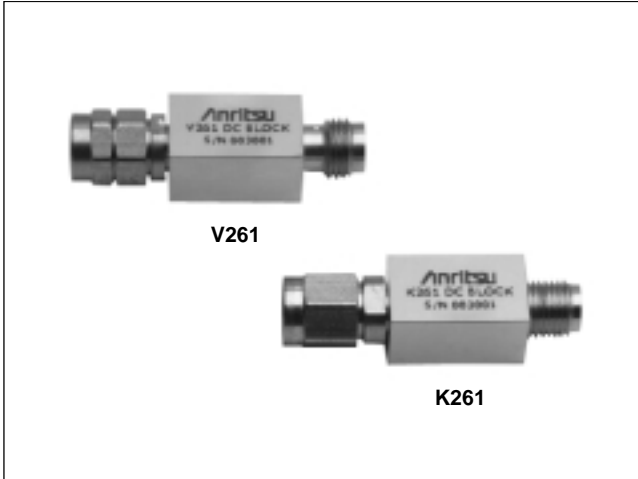

K261 outline drawing

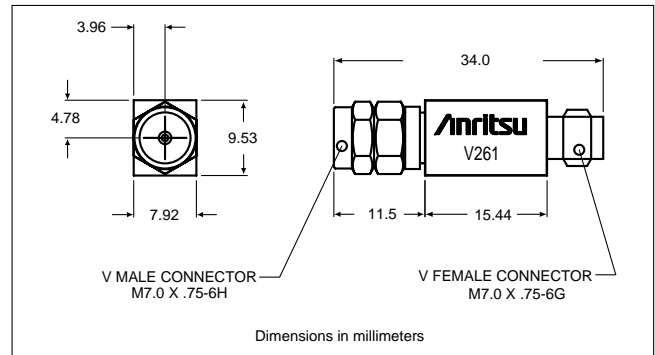

V261 outline drawing

These ultra-wide bandwidth DC Blocks have been optimized for optical communications and other high-speed pulse, data or microwave applications. Designed to apply AC drive signals to a device while eliminating any DC components, these DC Blocks feature wide bandwidth, excellent low frequency response, minimum insertion loss and flat group delay. Precision K Connector® and V Connector® interfaces assure excellent impedance match across the wide bandwidths available. A one year warranty is provided.

Features

- Ideal for Optical Communications and high-speed Pulse Applications
- <1.0 dB Insertion Loss (K261)
- Risetime: <5 ps (V261), <7 ps (K261)

Specifications

Model	Frequency range	Insertion loss	Return loss	Rise time	Group delay	Max DC voltage	Max RF power	Connectors
K261	10 kHz to 40 GHz	<1.0 dB typical	See Plot	<7 ps typical	110 ±1 ps typical	16 VDC	1 W	RF In: K(m) RF Out: K(f)
V261	50 kHz to 65 GHz	<2.0 dB typical	See Plot	<5 ps typical	113 ±1 ps typical	16 VDC	1 W	RF In: V(m) RF Out: V(f)

Specifications apply over the temperature range of 0°C to +70°C.

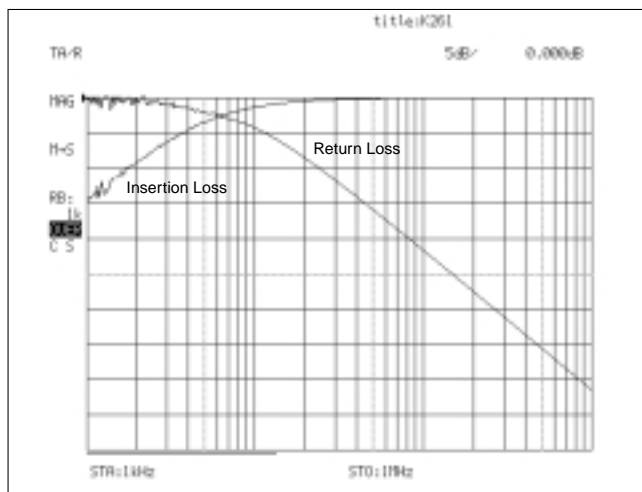

Typical Low Frequency Insertion Loss measured on K261 over the range of 1 kHz to 1 MHz.

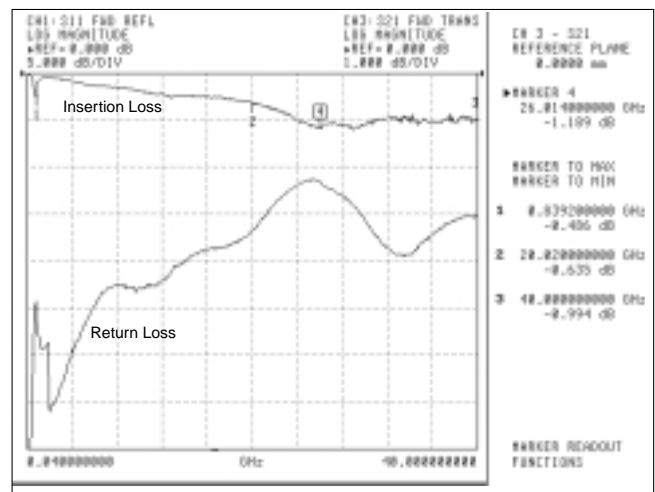

Typical Insertion Loss and Return Loss measured on K261 over the range of 40 MHz to 40 GHz.

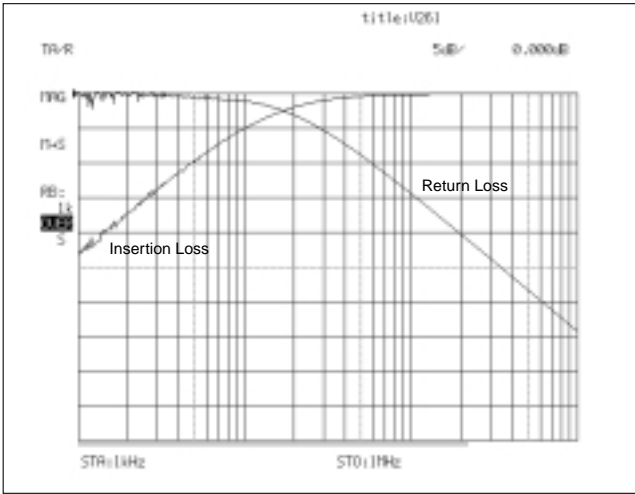

Typical Low Frequency Insertion Loss measured on V261 over the range of 1 kHz to 1 MHz.

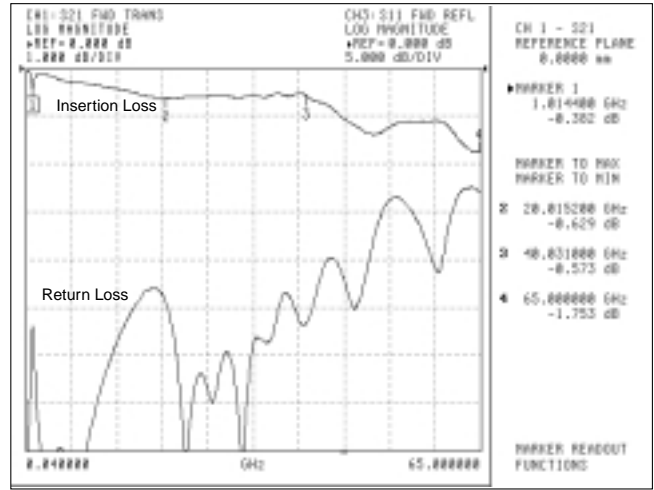

Typical Insertion Loss and Return Loss measured on V261 over the range of 40 MHz to 65 GHz.

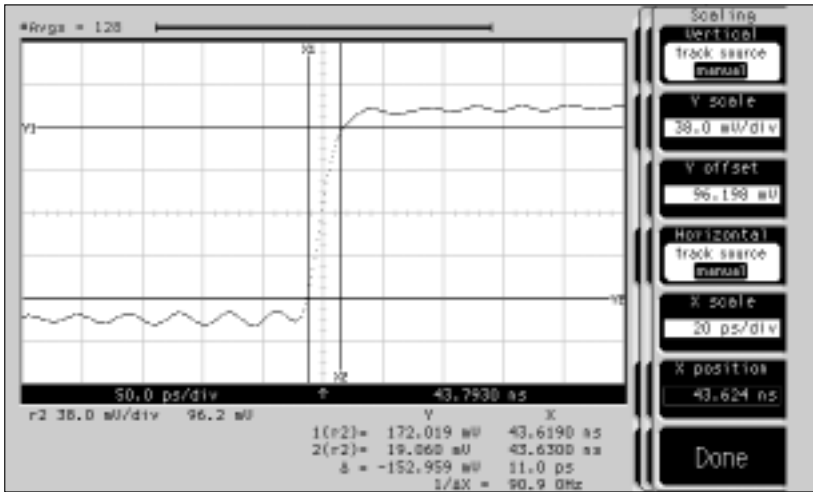

Typical Uncorrected Pulse Response for V261. Absolute risetime for the DC Blocks is derived from this measured data by applying the RSS method to compensate for the risetime of the input pulse.

$$\sqrt{T_{BT}^2 + T_{PG}^2} = T_{meas.}$$

$T_{meas.}$ = uncorrected risetime
 T_{BT} = absolute Bias Tee risetime
 T_{PG} = risetime of input pulse

$$T_{BT} = \sqrt{T_{meas}^2 - T_{PG}^2}$$

Ordering information

Please specify model/order number, name, and quantity when ordering.

Model/Order No.	Name
K261	Precision DC Block, 50 kHz to 40 GHz
V261	Precision DC Block, 100 kHz to 65 GHz

DC BLOCK
V265
50 kHz to 65 GHz

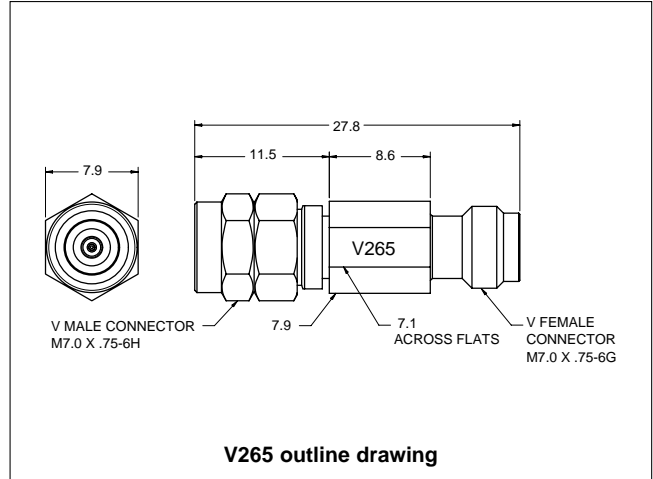

The V265 DC Block has been designed and optimized for optical communications and other high speed pulse, data or microwave applications. Based on the coaxial resilient connection – which is the same as on our V255 Gen II Bias Tee – it provides excellent low frequency response with very low losses and flat group delay over the temperature of operation. Designed to apply AC drive signals to a device while eliminating any DC voltage or current components, the V265 DC Block can be used in isolating DC leakage between two electrical components. The DC block comes with a standard V Connector® and assures excellent impedance match across the wide bandwidth available. A one-year warranty is provided.

Features

- Ideal for Optical Communication applications.
- Low Insertion Loss
- Rise Time 3 ps typical

Specifications

Model	Frequency range	Insertion loss	Return loss	Max RF power	Connector	Max DC voltage	Rise Time	Group delay	Operating temp.
V265	50 kHz to 65 GHz	0.9 dB to 65 GHz typ.	13 dB to 65 GHz typ.	1 W	RF In: V(f) RF Out: V(m)	10 V	3 ps typ.	84 ±2 ps typ.	0°C to 80°C

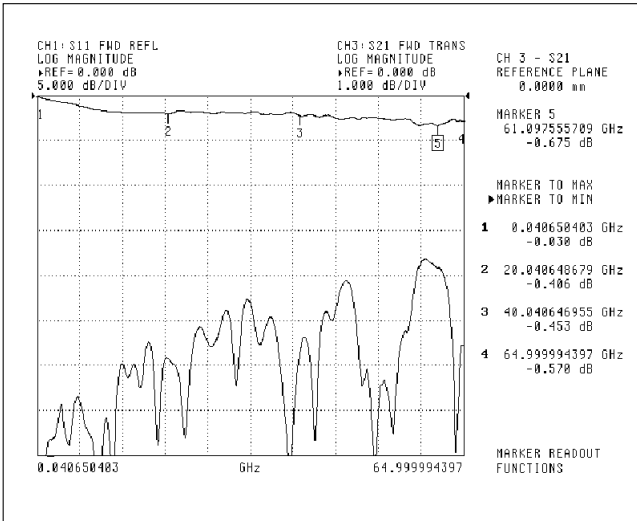

Typical High Frequency Insertion Loss and Return Loss measured on V265 DC Block over the range of 40 MHz to 65 GHz

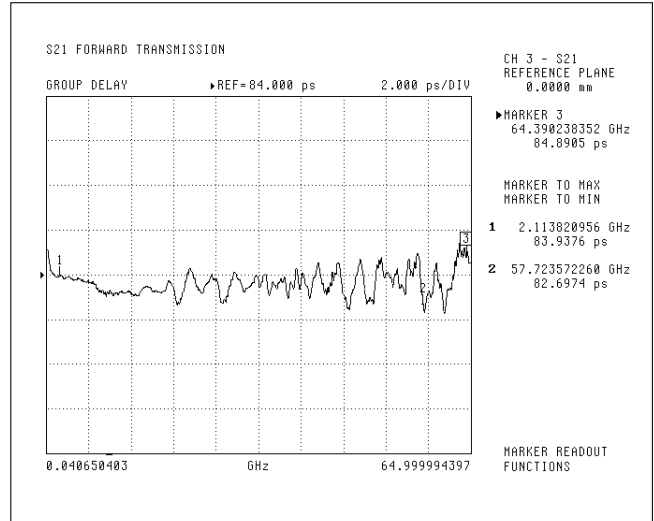

Typical Group Delay Performance measured on V265

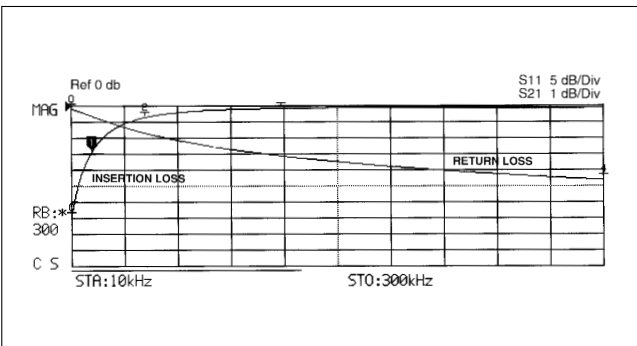

Typical Low Frequency Insertion Loss and Return Loss on V265 DC Block over the range of 10 kHz to 300 kHz

Ordering information

Please specify model/order number, name, and quantity when ordering.

Model/Order No.	Name
V265	DC Block, 50 kHz to 65 GHz

UNIVERSAL TEST FIXTURES

3680 Series

DC to 60 GHz



The 3680 series provide an accurate, repeatable solution for measuring microstrip and Coplanar substrate devices. Input and output connections are made to the substrate device by two spring-loaded jaws that include coax-to-microstrip/Coplanar launchers. The jaws accommodate substrates from 5 to 75 mils in thickness. No center section is required. One jaw is movable in two dimensions to accommodate substrates up to 2 inches long (4 inches for 3680-20) and substrates with line offsets of up to 1/2 inch (1 inch for 3680-20). The 3680 series includes three models: the 3680-20 covers DC to 20 GHz with APC-3.5™ connectors, the 3680K covers DC to 40 GHz with Anritsu's K Connector®, and the 3680V covers DC to 60 GHz with Anritsu's V Connector®.

Features

- DC to 60 GHz coverage
- Microstrip and coplanar measurement capability
- Accommodates offset and right-angle test devices
- Calibration/verification kits (optional)
- Substrate measurement capability

Electrical

Model	Universal Test Fixture			Right-Angle Launcher		MMIC Attachment
	3680-20	3680K	3680V	36801K	36801V	36802
Frequency range (GHz)	DC to 20	DC to 40	DC to 60	DC to 40	DC to 60	DC to 60
Return loss (dB)						
DC to 20 GHz	>17	>17	>17	>16	>16	>12
20 to 40 GHz		>14	>14	>12	>12	>8
40 to 60 GHz			>8		>7	>6
Repeatability (dB)						
DC to 20 GHz	<±0.10	<±0.10	<±0.10	<±0.15	<±0.15	<±0.20
20 to 40 GHz		<±0.20	<±0.20	<±0.25	<±0.25	<±0.40
40 to 60 GHz			<±0.30		<±0.40	<±0.60

Temperature -20° to 70°C

Ordering information

Please specify model/order number, name and quantity when ordering.

Model/Order No.	Name
	Main frame
3680-20	Universal Test Fixture (20 GHz)
3680K	Universal Test Fixture (40 GHz)
3680V	Universal Test Fixture (60 GHz)
	Accessories
36801K	Right-Angle Launcher (40 GHz)
36801V	Right-Angle Launcher (60 GHz)
36802	MMIC Attachment
36803	Bias Probe
36805-10M	10 mil launchers*1
36805-15M	15 mil launchers*1
36805-25M	25 mil launchers*1
	Calibration/verification kits
36804B-10M	10 mil microstrip cal/verif. kit
36804B-15M	15 mil microstrip cal/verif. kit
36804B-25M	25 mil microstrip cal/verif. kit
36804-25C	25 mil coplanar waveguide cal/verif. kit

*1: 36805 series includes (4) substrate launchers for the 36802 MMIC attachment

3680 series Universal Test Fixture	Substrate types supported	Microstrip or coplanar waveguide
	Overall size	10 x 12.7 x 6.4 cm
	Substrate length	0.5 cm min. 5 cm max. [10 cm with 3680-20]
	Maximum substrate width	No limit
	Substrate thickness	0.012 cm min. 0.19 cm max.
	Maximum line offset	±1.2 cm [±2.5 cm with 3680-20]
	Input and output connectors	3680-20: APC-3.5™ female 3680K: K Connector® female 3680V: V Connector® female
36802 MMIC Attachment	Substrate thickness	0.0 cm, 0.038 cm, 0.064 cm
	Minimum test substrate length	1.5 mm
	Maximum test substrate length	1.17 cm with standard block
	Maximum line offset	±1.2 cm
36801 Right Angle Launcher	Distance from in-line connector, axial	Minimum: 1 cm Maximum: 4 cm
	Distance from in-line connector, offset	Minimum: 0.0 cm Maximum: 2 cm

LIMITERS

1 Series

1 MHz to 26.5 GHz

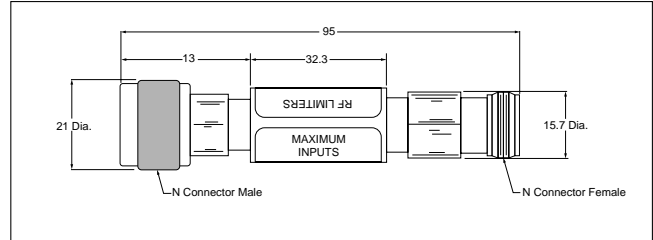
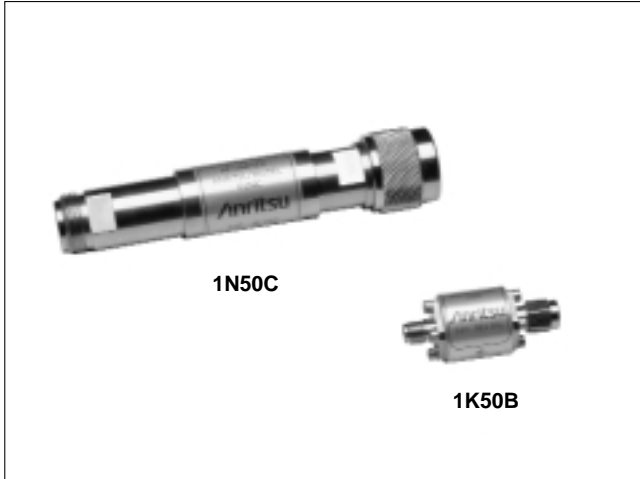

1N50C and 1N75C Limiters outline

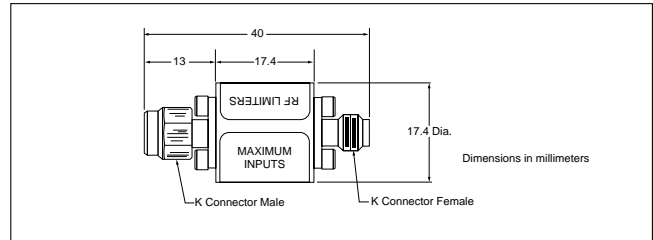

1K50A and 1K50B Limiters outline

Features

- High power protection: 5 Watts
- Very fast turn-on time: 10 ns max.
- Broad frequency range: 0.01 to 26.5 GHz
- Low insertion loss: 2.7 dB to 20 GHz
- Excellent return loss: 11 dB at 20 GHz
- Single side limiting

Specifications

Model	1K50B	1K50A	1N50C	1N75C	1N50B	1N75B
Frequency range	0.01 to 26.5 GHz	0.01 to 20 GHz	0.01 to 18 GHz	0.01 to 3 GHz	0.01 to 3 GHz	0.01 to 3 GHz
Max. input power	3 Watts	5 Watts	5 Watts	5 Watts	1.5 Watts	1.5 Watts
Min. return loss (at 0 dBm input)	10 dB	14 dB, ≤12 GHz 11 dB, >12 GHz	14 dB, ≤12 GHz 11 dB, >12 GHz	15 dB	19 dB	19 dB
Max. insertion loss (at 0 dBm input)	3.9 dB	2.7 dB	2.9 dB	1.1 dB	1.3 dB	1.3 dB
Max. turn-on time	10 ns	10 ns	10 ns	10 ns	10 ns	10 ns
Input connector	K(m)	K(m)	N(m)	75 Ω N(m)	N(m)	75 Ω N(m)
Output connector	K(f)	K(f)	N(f)	75 Ω N(f)	N(f)	75 Ω N(f)
Input/output coupling	DC	DC	DC	DC	AC	AC

Limiting Level: Limiter begins compressing at approximately +10 dBm. In compression, output level increases by 0.25 to 0.5 dB for each 1 dB increase at the input. Output power at 5 W input at 500 MHz is 21 dBm max. Dimensions: 1N50B and 1N75B 3.8 cm x 2.5 cm x 2.5 cm Temperature range: 0°C to +70°C

Ordering information

Please specify model/order number, name, and quantity when ordering.

Model/Order No.	Name
	Limiter
1N50C	N(m) to N(f), 50 Ω, 10 MHz to 20 GHz
1N75C	N(m) to N(f), 75 Ω, 10 MHz to 3 GHz
1K50A	K(m) to K(f), 50 Ω, 10 MHz to 20 GHz
1K50B	K(m) to K(f), 50 Ω, 10 MHz to 26.5 GHz

MATCHING PADS

12 Series

DC to 3000 MHz



Specifications

Model	Frequency range (MHz)	SWR	Insertion loss (dB)	Connectors
12N50-75B	DC to 3000	1.25	7.5 max.	N(m) 5 Ω to N(f) 75 Ω
12N75B	DC to 3000	1.25	3.0 max.	N(m) 50 Ω to N(m) 75 Ω

Temperature range: 0°C to +70°C
 Dimensions: 3.8 cm x 2.5 cm x 2.5 cm

Ordering information

Please specify model/order number, name, and quantity when ordering.

Model/Order No.	Name
12N50-75B	Matching Pad, DC to 3000 MHz
12N75B	Minimum Loss Adapter, DC to 3000 MHz

RF matching pad and impedance adapter features

- DC to 3000 MHz frequency range
- Matching pad matches 50 Ω to 75 Ω or 75 Ω to 50 Ω circuits
- Impedance adapter converts 50 Ω to 75 Ω with <3 dB loss

The 12N50-75B matching pad is a two-resistor design that matches 50 Ω to 75 Ω or 75 Ω to 50 Ω circuits.

The 12N75B impedance adapter is a one-resistor design that converts 50 Ω to 75 Ω with less than 3 dB loss.



BROADBAND TEST EQUIPMENT

Outline of broadband test systems	520
DATS ^{PLUS} ®	521
eDATS®	521
BTS®	521
MATS ^{PLUS} ®	522
SMATS ^{PLUS} ®	522
TAPESTRY®, Fault Management OSS	522
Hi-Cap Test System	523
STAC	523
SICU	523

OUTLINE OF BROADBAND TEST SYSTEMS

Broadband test equipment performance is crucial in a business that considers 98% service availability unacceptable. To help service providers exceed that standard, Anritsu's Broadband systems perform access, test and performance monitoring on over 2,000,000 circuits at 35 service providers, in ten countries everyday.

There is a good reason for this acceptance:

- Value through unequaled service, and low-cost, modular design
- Downloadable software that gets systems on-line fast, makes upgrading easy, and avoids obsolescence

Anritsu's Broadband products enable testing of analog and digital circuits at remote locations – without having to dispatch service personnel. With Anritsu's Broadband equipment installed at central offices, service providers can both reduce their maintenance and repair costs and offer customers more reliable services. Problems anywhere on the circuit can be pinpointed quickly. Accurate test results allow service providers to dispatch more effectively, resulting in an efficient use of maintenance personnel and faster service restoration. And because Anritsu's Broadband products are modular, service providers can add functionality at any time without needing to replace existing equipment.

The Three Major Components of Anritsu's Broadband Products are:

- Operations Support System (OSS) – test and performance monitoring
- Remote Access and Test Units – for numerous applications
- Service – design, installation, training and ongoing support

Remote test and monitor systems reduce expenses and improve service quality with:

- Savings in pre-service testing and restorals for VF, DDS and HiCap circuits. A single tester can remotely access and test a section of a circuit between both ends
- Fewer dispatches, reduced travel time and costs, due to rapid, accurate sectionalization and fault isolation
- Consistent test results, due to commonality of equipment and methods
- Comprehensive DS1 and DS3 circuit performance reports generated from full-time circuit monitoring data
- Proactive DS1 and DS3 maintenance via alarm reporting when preset thresholds are exceeded

Anritsu's remote test and monitor system provides even more features:

- Modular flexibility – buy only the equipment and test functionality you need today, with seamless expansion tomorrow
- Equipment reliability – high mean-time-between-failures (MTBF) results from careful design and production controls; low mean-time-to-repair results from extensive self-testing and planned accessibility
- Rapid updating – remotely downloadable software to remote test units
- Redundant relay contacts with continuity testing ensure reliable metallic circuit access and release
- Metallic and digital access/monitor with a full complement of industry-standard intrusive tests
- Full compliance with industry standards

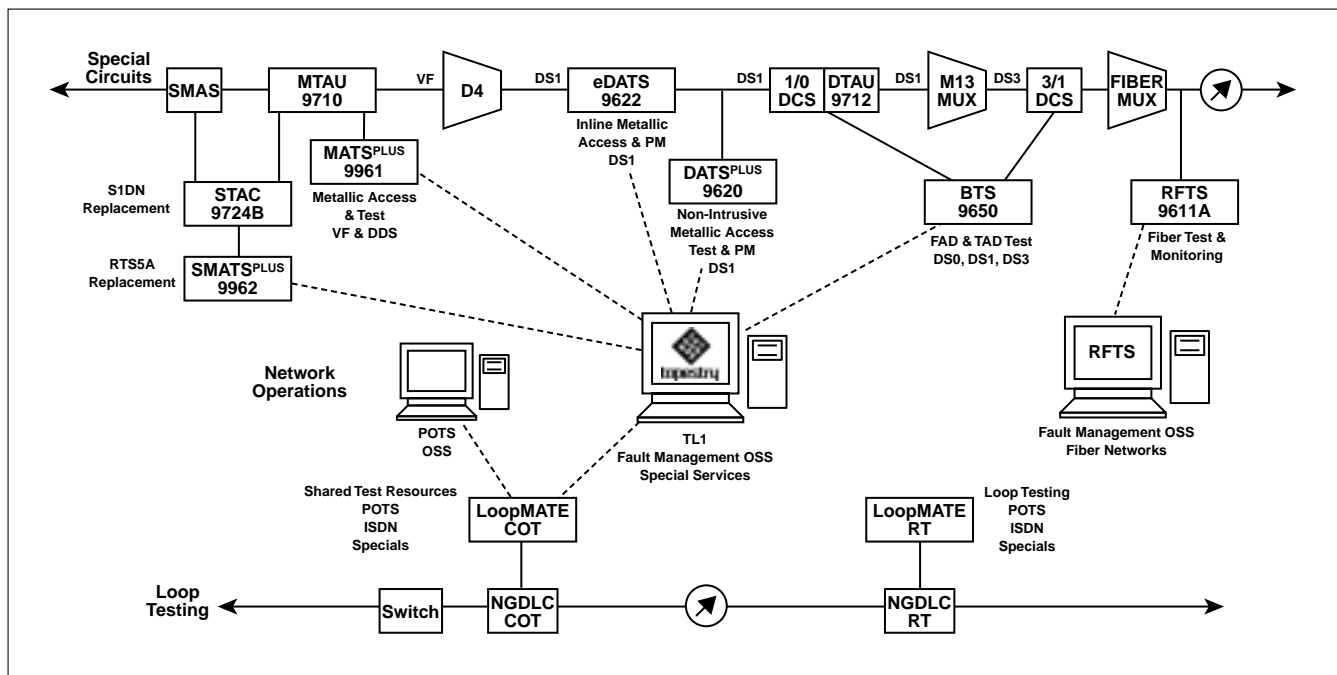
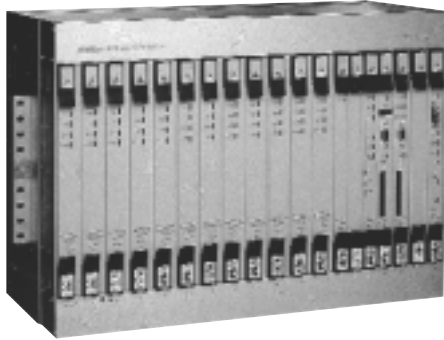

Fig. 1 Network test components

DATS^{PLUS}[®] 9620

For DS1 Access, Test and PM



The Digital Access and Test System^{PLUS}, DATS^{PLUS}[®], is the new generation of DS1 access, test and performance monitoring systems from Anritsu. Building upon Anritsu's long-standing reputation for reliable and cost-effective products, DATS^{PLUS}[®] offers a fully-featured solution built around the latest Telcordia Technologies (formerly Bellcore) and ANSI standards for managing DS1 networks: TR-NW-834, TR-NWT-833, TR-NWT-820 and T1.231. The 9620 enables you to significantly improve service in your network, and to deliver the high quality service assurance desired by your customers. It reduces response time to network problems and lowers your overall operating expenses in DS1 maintenance.

The DATS^{PLUS}[®] system is automatically inventoried and provisioned via the Telcordia TIRKS[®] Operations Support System, and its circuit access database is automatically loaded into Telcordia's NMA[®] OS via TIRKS flow-through. The DATS^{PLUS}[®] is also easily installed due to its fully connectorized backplane architecture. Future OS interoperability is assured by our commitment to an open-system architecture, as well as by our active participation in the OSMINE[®] process at Telcordia.

- Integrated circuit access, test and performance monitoring
- Upgradable via downloadable software
- The industry's best solution for DS1 maintenance

eDATS 9622

For Digital Access and Test



The enhanced Digital Access and Test System, (eDATS) from Anritsu is the latest generation in features, performance and customer value for managing DS1 and DS0 circuits in your HiCap network. Interfacing at the DSX-1, eDATS allows you to monitor and test DS1, DS0, VF, DDS and Fractional-T1 circuits, all from one compact shelf. And eDATS offers the latest industry-standard DS1 Performance Monitoring features including PM from intelligent NIUs.

- DS1 HiCap access, test and performance monitoring – at the DSX
- DS0, VF and DDS and Frac-T1 monitor and test in the same system without backhauling circuits
- Low initial cost – expand as service needs demand
- In-line signal regeneration allows installation up to 650 feet from the DSX, giving you the much needed flexibility to place it in the central office

BTS 9650

For Managing DS1 and DS0 Circuits



The Anritsu Broadband Test System, BTS, is a multi-user, multi-function digital test system for testing at broadband, wideband and narrowband rates. The BTS can be configured for a variety of access and testing combinations of DS0, DS1, VT1.5 and DS3 HiCap digital circuits from one compact test system. Designed-in flexibility allows the unit to be optimized for small to large offices to provide hitless monitoring and intrusive/non-intrusive testing at Digital Cross-connect Systems (DCSs).

The BTS is the single shelf solution for high-speed testing via a DS3 single or dual FAD (facility access digroup), VT1.5 payload testing via a STS-1 TAD (test access digroup), DS1 testing via a single or dual FAD, and DS0 and Fractional-T1 testing via a FAD or TAD.

- Monitor and test access at DS3 and DS1 digital cross-connect systems
- Manage multiple network test elements in one compact shelf
- Up to 6 DS3 or STS-1/VT1.5 and up to 24 DS1/DS0 or 12 VF/DDS test sessions
- Standard TL1 and PDS Snider Communications

MATS^{PLUS}[®] 9961

For Metallic Access and Test

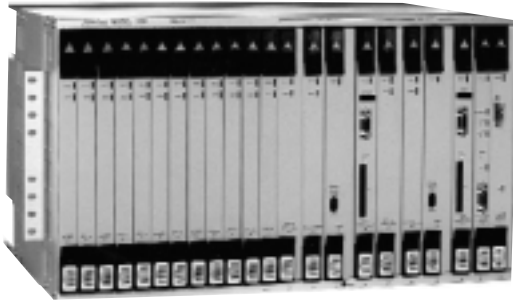

The Metallic Access and Test System^{PLUS}, MATS^{PLUS}[®], is the perfect solution for the testing requirements of any size central office. MATS^{PLUS}[®] is an advanced, special services remote test system that combines multiple test capabilities and plug-in circuit access modules into one compact shelf. Each test head can perform a wide variety of tests including voice frequency (VF), DS0A digital data service (DDS), analog data impairments, DDS loop qualification and multimeter. The optional plug-in site controller (TSC function) has a direct X.25 interface and supports up to 7 MATS^{PLUS}[®] shelves (14 test heads).

- Up to two test heads per shelf, each capable of VF and DDS testing
- Grow from a small to a large office without replacing hardware
- Remotely download software upgrades
- Industry-standard TL1 interface works with any TL1 OS

SMATS^{PLUS}[®] 9962

Plug-for-Plug RTS5A Replacement



Using the same advanced software-based test modules as the MATS^{PLUS}[®], SMATS^{PLUS}[®], Model 9962, extends metallic testing to embedded AT&T SMAS access systems, with or without an S1DN. A plug-for-plug replacement for AT&T's RTS5A systems, one 12-inch high SMATS^{PLUS}[®] shelf can replace up to five rack-feet of RTS5A equipment. SMATS^{PLUS}[®] is also the ideal replacement for AT&T's RMS-M systems.

SMATS^{PLUS}[®] directly interfaces SMAS maintenance connector controllers or distribution networks, S1DN superquads, network interface control units, SMAS 5B Connector Group Networks, and jack, key and lamp panels. For RTS5A systems, both controller and RTPPs are replaced.

- Cost effective plug-for-plug RTS5A replacement
- Up to two VF and DDS test heads in each shelf
- Remotely download software upgrades
- Remote maintenance and diagnostics capability

FAULT MANAGEMENT OSS TAPESTRY

An Integrated Test, PM and Alarm OSS



Tapestry is a powerful fault management tool for analog, DDS, DS1 and DS3 services that helps service providers stay competitive in today's exploding telecommunications market. It combines advanced test, PM, and alarm functions into one system, interfaces with existing provisioning and trouble ticket OSSs, is UNIX-based, and provides a simple "point and click" graphical user interface to reduce testing time, manpower requirements, and training. Additionally, its advanced testing features help meet customers' demands for shorter circuit downtime and means that less-experienced testers are more effective.

- Integrated test, PM and alarm
- Interface to circuit database and trouble ticketing systems
- Powerful open platform simplifies customization: UNIX, X-Window, Motif, relational database
- Quick testing with GUI and automatic test sequences
- Simple operation with pass/fail analysis of test results
- Online context-sensitive help
- Scalable client-server architecture
- Requires less training

DS3 HI-CAP TEST SYSTEM MP1033A

DS3 Monitor, Access and Test

NEW



The Anritsu MP1033A is a combination access, test and performance monitor system for DS3 circuits. It enables a service provider to non-intrusively determine the quality of the signal at the DSX3 in the central office as well as at the point where service is delivered to the customer. It can be the tool to provide documented proof of service quality to the end user, or at the point of hand-off between an ILEC and a CLEC. In the event of an outage, the equipment can help pinpoint faults - and the responsible party - to support quick service restoration.

- DS3 Performance Monitoring, access and test in a single shelf
- Works with NIU at customer premises to non-intrusively characterize service quality
- Fail-safe circuit path redundancy
- Redundant power supplies
- Seamless operations integration

STAC 9724B

Drop-in Replacement for S1DN



The Anritsu SMAS Test Access Concentrator (STAC), Model 9724, is a plug-for-plug replacement for aging and maintenance intensive AT&T Stage One Distribution Networks (S1DNs). STAC operates transparently with existing RTS5A test systems and Anritsu's SMATS^{PLUS} RTS5A replacement system. It can be used to replace all S1DNs in a system or to selectively replace individual S1DNs while other S1DNs in the system are left in place. STAC provides significant technical and economic advantages over existing S1DNs through increased reliability.

- Plug-for-plug S1DN replacement
- Hermetically sealed relays reduce maintenance and increase reliability
- S1DN-like architecture supports all elements of SMAS
- Transparent to RTS5A or Anritsu's SMATS^{PLUS} RTS5A replacement
- Can be mixed with existing S1DNs for gradual migration

SICU 9725

Drop-in Replacement for NICU

NEW



The Anritsu SMAS Interface Control Unit, (SICU), is a plug-for-plug replacement for aging and maintenance intensive AT&T Network Interface Control Units, (NICUs). The SICU operates transparently with existing RTS5A test systems and Anritsu's SMATS^{PLUS} RTS5A replacement system. It can be used to replace all AT&T NICUs in a system or to selectively replace individual NICUs while other AT&T's NICUs in the system are left in place. SICU provides significant technical and economic advantages over existing AT&T NICUs through increased reliability.

- Plug-for-plug NICU replacement
- Hermetically sealed relays reduce maintenance and increase reliability
- NICU-like architecture supports all elements of SMAS
- Transparent to RTS5A or Anritsu's SMATS^{PLUS} RTS5A Replacement can be mixed with existing NICUs for gradual migration



PERIPHERAL EQUIPMENT & PARTS

Pads	526
Impedance Transformer	526
Directional Couplers	527
Branch	527
High-Pass Filter	528
Fixed Attenuator for High Power Measurement . . .	528
Portable Test Rack	528
RF Amplifier	529
High Speed Driver	530
Bessel Filter	531
Phase Shifter	532
Bias Tee	533
Coaxial Cords, Adapters	534
Dimensions of Waveguide Flanges	536
Accessories for F-Series Cabinets	537
Accessories for E-Series Cabinets	539

T-PAD

Z-164A, Z-164B

DC to 1 GHz DC to 200 MHz

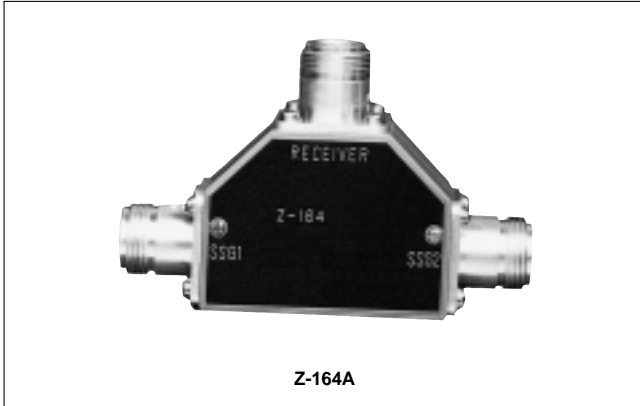

Z-164A

The Z-164A/B is used as a matching pad for applying the mixed output of two signal generators to the input terminal of a receiver for measuring two-signal characteristics (such as the blocking and intermodulation characteristic) of the receiver.

Specifications

Model	Z-164A	Z-164B
Frequency range	0 to 1000 MHz	0 to 200 MHz
Insertion loss	6±0.5 dB (voltage ratio)	
Impedance characteristics	50 Ω VSWR: ≤1.3 (up to 500 MHz) ≤1.5 (≥500 MHz)	75 Ω VSWR: ≤1.2 (up to 200 MHz)
Connector	N (S)-J	M-J
Operating temperature	0° to 45°C	

Note: The maximum allowable power is 0.5 W

FOUR-PORT JUNCTION PAD

MP659A, MA1612A

40 MHz to 1 GHz 5 MHz to 3 GHz



The MP659A and MA1612A are used as an impedance matching box applying the mixed output of three RF signal generators to a receiver input terminal for measurement of three-signal characteristics (such as receiver SINAD performance).

50 Ω ↔ 75 Ω IMPEDANCE TRANSFORMER

MP614A, MB-009

10 to 1200 MHz DC to 2 GHz



The MP614A is used over the range from 10 to 1200 MHz mainly for changing the impedance of a measuring signal source such as a signal generator. It is a transformer type, so that it has a smaller loss than a resistance attenuator type, and does not lower the signal source level. When the output level of a signal generator is shown in a power unit as in dBm, the output level after impedance transforming by the MP614A will have a value which is obtained by subtracting the insertion loss (dB) of the impedance transformer from the output level of the signal generator.

The MB-009 is constructed so that the central connector will not be damaged if 50 Ω N-type plug is connected by mistake to the 75 Ω side.

CM DIRECTIONAL COUPLER
MP520 series
 25 to 1700 MHz

This coupler is used in the measurement of fundamental frequency power and spurious power which supplies coaxial feeders in VHF and UHF bands. Various models are provided in accordance with feeder impedance and frequency. It is also capable of measuring the VSWR of antenna systems.



MP520A

DIRECTIONAL COUPLER
MP654A, MP655A
 0.8 to 3 GHz 3.0 to 4.4 GHz

The MP654A and MP655A are used to branch one part of the transmitted output for such measurements as those of fundamental wave and higher harmonic spurious characteristics using a spectrum analyzer. The MP654A is used for measuring personal radio transceivers and automobile telephones while the MP655A is used for measuring microwave band ratio equipment.

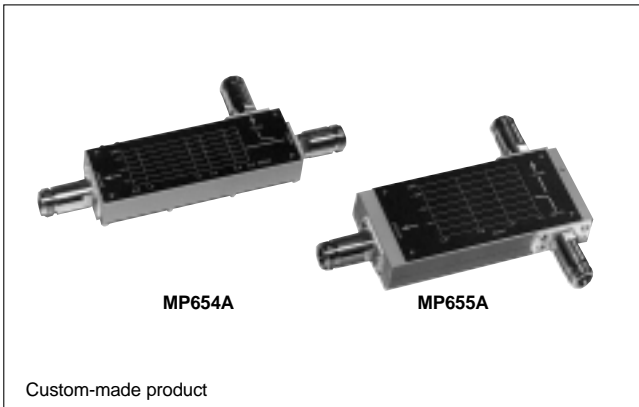

MP654A

MP655A

Custom-made product

Specifications

Model	MP654A	MP655A
Frequency range	0.8 to 3 GHz	3 to 4.4 GHz
Impedance	50 Ω (N connector)	
Coupling	Approx. 30 dB*	
Input power (max.)	50 W	

*: Calibration data reattached

BRANCH
MP640A
 DC to 1700 MHz

The MP640A is used for branching a part of the transmitted signal in measuring the spurious characteristics of a transmitter with a field strength meter or a spectrum analyzer. Its frequency characteristics of attenuation is flat over DC to 1700 MHz, so that it can be conveniently utilized for measurement without taking the frequency characteristic into consideration. The maximum allowable input power is 16 W.

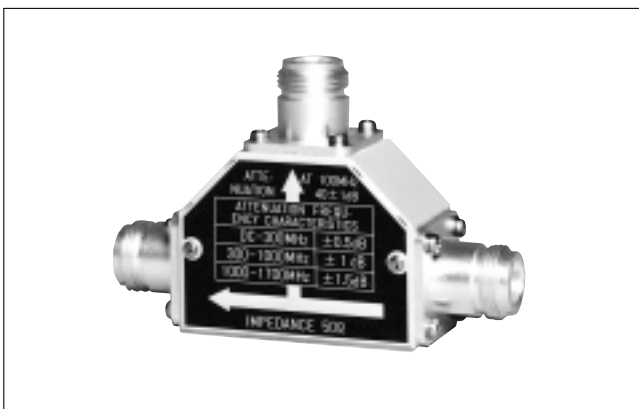

HIGH-PASS FILTER
MP526 series

27/60/150/250/400 MHz bands

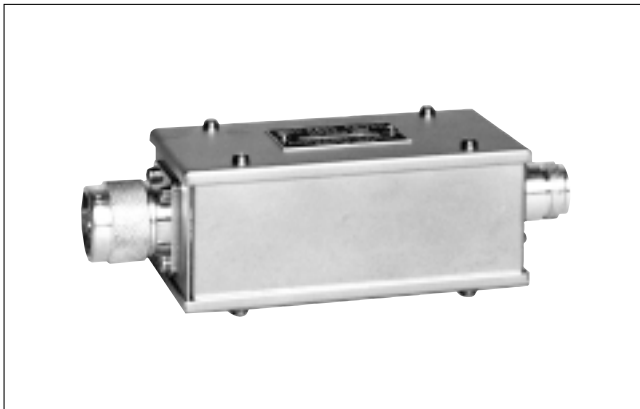

The MP526 series is for measuring the spurious characteristics with a field strength meter or a spectrum analyzer. Eliminating the fundamental signal by using a filter prevents the internal spurious of the field strength meter or spectrum analyzer due to an excessive input to facilitate measurement. A, B, C, D, and G are available to suit the five different frequency bands. The maximum allowable input level is +10 dBm.

FIXED ATTENUATOR FOR HIGH POWER MEASUREMENT



Order No.	Attenuation	Frequency range	Remarks
J0063	30 dB	DC to 12.4 GHz	N-type connector, permissible max. power 10 W (+40 dBm)
J0078	20 dB	DC to 18 GHz	
J0395	30 dB	DC to 8 GHz	N-type connector, permissible max. power 30 W (+44.7 dBm)

PORTABLE TEST RACK
MB23A, MB24A

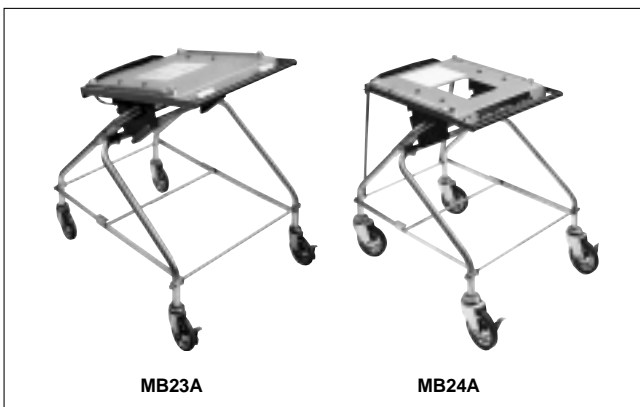

The MB23A and MB24A can be folded so they can be transported easily and used in places with space limitations. Metal fittings to accommodate both current and new cabinet designs are included.

MB23A

- By easy operation of the lever, the table can be inclined at five different angles for optimum instrument viewing ease.
- Thanks to Anritsu's exclusive construction, just a light touch of the lever is all it takes to move the angle safely up to 45°.

MB24A

- The table is fixed in a horizontal position.
- Since the rack can support up to 100 kg, several instruments may be stacked.

RF AMPLIFIER

For Amplifying High Speed Digital Signals

The A3H series comprises amplifiers which maintain flat gain and group delay characteristic in a wide band range up to 20 GHz, amplifying with great fidelity ultra high-speed pulse waveforms. It can be

used for a variety of application fields including ultra wideband signal amplification, ultra high-speed pulse amplification, and measuring instruments pre-amplification.

Specifications (Typical values. For more details, ask for the separate catalog.)

Model	Frequency range	Gain	Tr/Tf	Group delay (max.)	Overshoot (max.)	Output amplitude	NF	Remarks
A3H2200	100 kHz to 20 GHz	20 dB	20 ps	±100 ps	15%	1.2 V(p-p)	7 dB	For 20 GHz
A3H2150	100 kHz to 15 GHz	20 dB	23 ps	±100 ps	15%	1.5 V(p-p)	7 dB	For 15 GHz
A3H2120	100 kHz to 12 GHz	20 dB	30 ps	±100 ps	10%	1.5 V(p-p)	7 dB	For 12 GHz
A3HA2100	30 kHz to 10 GHz	20 dB	35 ps	±100 ps	10%	1.2 V(p-p)	7 dB	For 10 GHz, small size
A3HB3102	30 kHz to 10 GHz	28 dB	35 ps	±150 ps	10%	1.2 V(p-p)	4 dB	For 10 GHz, thin-type, low noise
A3H1001	100 kHz to 10 GHz	22 dB	35 ps	±100 ps	10%	1.5 V(p-p)	7 dB	For 10 GHz
A3H4080	100 kHz to 8 GHz	36 dB	50 ps	±100 ps	10%	1.4 V(p-p)	7 dB	For 8 GHz, high gain
A3H1002	100 kHz to 6 GHz	40 dB	58 ps	±100 ps	10%	1.5 V(p-p)	7 dB	For 6 GHz
A3H2051	DC to 5 GHz	20 dB	70 ps	±100 ps	10%	±0.6 V	7 dB	For DC to 5 GHz
A3H2030	100 kHz to 3 GHz	22 dB	117 ps	±100 ps	5%	1.3 V(p-p)	8.5 dB	For 3 GHz, low cost
A3H4030	100 kHz to 3 GHz	40 dB	117 ps	±100 ps	10%	1.3 V(p-p)	8.5 dB	For 3 GHz, high gain, low cost
A3H2121	DC to 12 GHz	20 dB	37 ps	±150 ps	10%	±0.6 V	7 dB	For DC to 12 GHz

Input/output schematic

• A3H2200

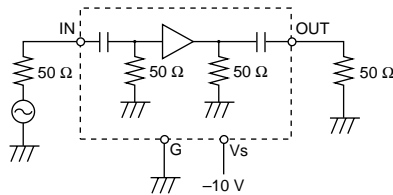

• A3HB3102

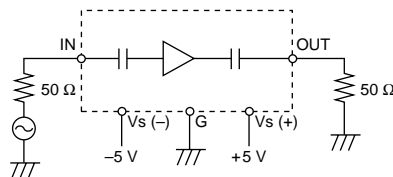

External dimensions diagram

• A3H2200

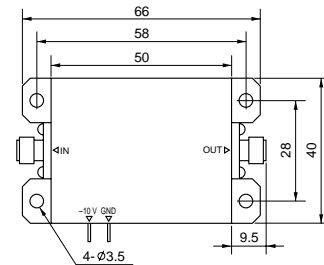

Applicable connector: SMA-type (units: mm)

• A3HB3102

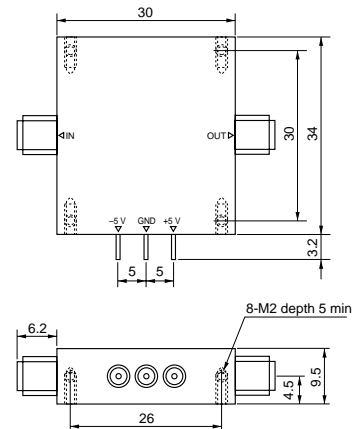

Applicable connector: SMA-type (units: mm)

HIGH SPEED DRIVER

For Driving Optical Modulators

The A3HE2096 is a high-speed and high-output voltage swing driver. It performs 6 V(p-p) output voltage swing, and it can be used as a driver for optical LN modulators, thanks to the external control terminal for adjusting output voltage swing.

Specifications (Typical values. For more details, ask for the separate catalog.)

Model	Frequency range	Gain	Tr/Tf	Group delay (max.)	Output amplitude	Remarks
A3HC2107	30 kHz to 10 GHz	20 dB	35 ps	±100 ps	5 to 7.5 V(p-p)	For 10 Gb/s
A3H2206	30 kHz to 20 GHz	20 dB	30 ps	±150 ps	5 V(p-p)	For 20 Gb/s
A3HE2096	40 kHz to 9 GHz	23 dB	40 ps	±100 ps	4 to 6 V(p-p)	For 12 Gb/s

Input/output schematic

- A3H2206

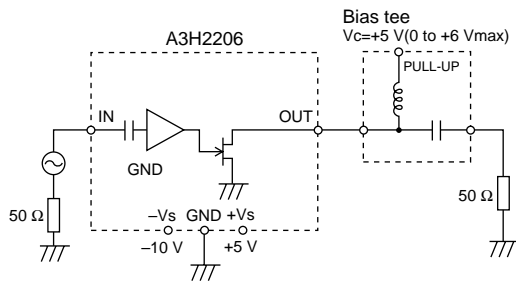

Characteristics example

- Pulse response (A3H2206)
10 Gb/s NRZ pattern [input: 1.0 V(p-p)]

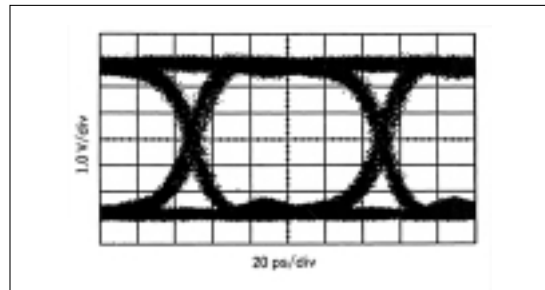

External dimensions diagram

- A3H2206

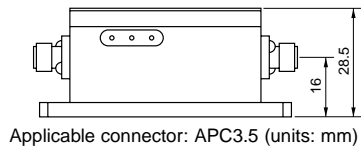
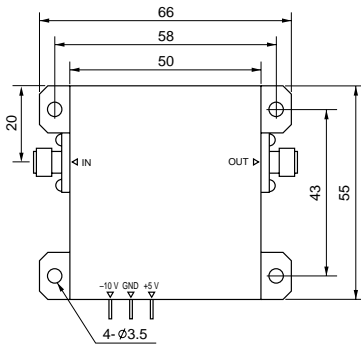

- Low signal frequency characteristic (A3H2206)

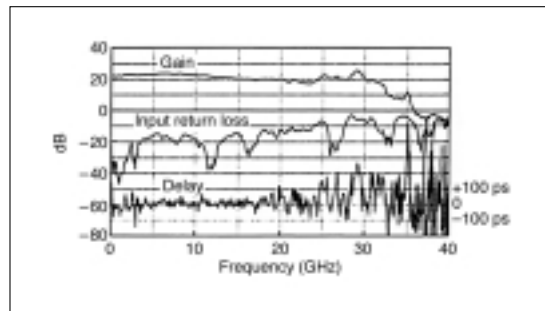

- 20 Gb/s optical modulation waveform (A3H2206)

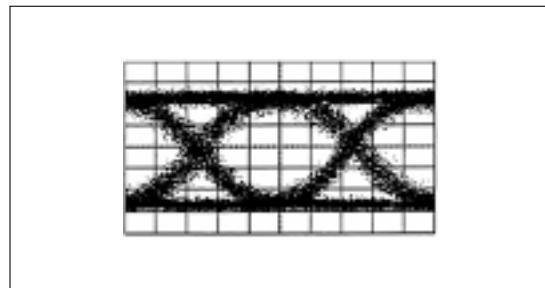

BESSEL FILTER AF1000 series

For Improving Error Rate of Digital Signals

Due to the increases in capacity and longer distances resulting from use of optical fibers and wider bandwidths, digital communications are becoming more susceptible to noise. Elimination of noise in signals and improvement of error rate requires use of waveform-equalizing filters.

The flat group-delay characteristics of Bessel filters cause very little degradation of signal waveforms, making them ideal for attenuating out-of-band noise. Furthermore, the excellent I/O return loss characteristics of the AF1010 eliminate the need for an impedance matching pad.

Specifications

Model	Degree	Cut-off frequency	Insertion loss fc/2 (dB)	Attenuation (dB)		Group delay deviation (ps)	Remarks
				2 fc	4 fc		
AF1003	5	2.5 to 5.9 GHz	0.7 ± 0.3*1	14 ± 2*2	>30*3	<45 (fc: 2.5 GHz) <30 (fc: 4 GHz)	SMA-F · SMA-F connector
AF1004		10 MHz to 2.4 GHz				<1000 (fc: 39 MHz) <60 (fc: 1.8 GHz)	
AF1008		6 to 12 GHz	0.7 ± 0.5	14 ± 3	>25	<20 (fc: -)	K-F · K-F connector
AF1010		1.7 to 7.5 GHz				<30 (fc: 4 GHz) <25 (fc: 7.5 GHz)	K-F · K-F connector, low-reflection type
AF1005	4	2.5 to 5.9 GHz	0.7 ± 0.5	14 ± 2*2	>30*3	<45 (fc: 2.5 GHz) <30 (fc: 4 GHz)	SMA-F · SMA-F connector
AF1007		10 MHz to 2.4 GHz	0.7 ± 0.3			<1000 (fc: 39 MHz)*4 <60 (fc: 1.8 GHz)*4	

- *1: 0.7 dB ± 0.5 dB (fc: ≥ 3.5 GHz)
- *2: 14 dB ± 3 dB (fc: ≥ 3.5 GHz)
- *3: >25 dB (fc: ≥ 3.5 GHz)
- *4: Value corresponding to each fc

External dimensions diagram

• AF1003, AF1005

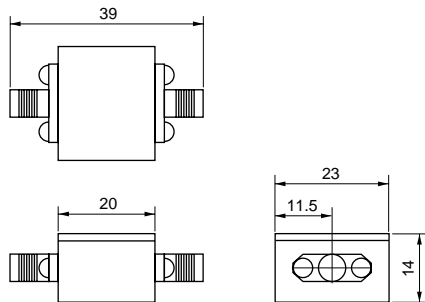

• AF1004, AF1007

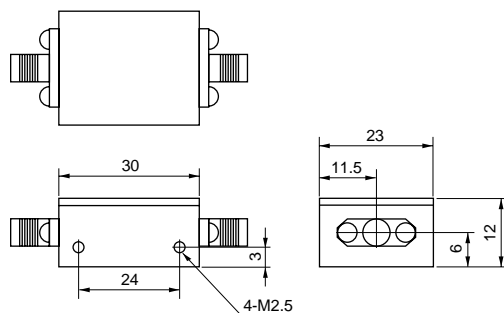

PHASE SHIFTER

A5N1001, A5N1102

DC to 40 GHz DC to 11 GHz

For Phase Adjustment of Ultra High Speed Digital Circuits

A5N1001/A5N1102 are a mechanical delay line, and so is ideal for phase adjustment of ultra high-speed digital circuits.

Specifications

Model	A5N1001	A5N1102
Frequency range	DC to 40 GHz	DC to 11 GHz
Min. delay time	705 ps (typ)	320 ps (typ)
Max. delay time	845 ps (typ)	430 ps (typ)
Variable phase range	50°/GHz (typ)	40°/GHz (typ)
Return loss	≥12 dB (DC to 20 GHz) ≥10 dB (20 to 40 GHz)	≥15 dB (DC to 5 GHz) ≥12 dB (5 to 10 GHz) ≥11 dB (10 to 11 GHz)
Insertion loss	≤1.4 dB (DC to 20 GHz) ≤2.0 dB (20 to 40 GHz)	≤0.7 dB (DC to 5 GHz) ≤1.0 dB (5 to 10 GHz) ≤1.2 dB (10 to 11 GHz)
Adjustable angle	Approx. 16 turns	Approx. 98°
Mass	Approx. 150 g	Approx. 25 g

Environmental conditions

Model	A5N1001	A5N1102
Operating temperature	0° to +70°C	-5° to +70°C
Storage temperature	-10° to +75°C	-20° to +75°C
Vibration	10 to 55 Hz (full magnitude: 1.5 mm)	
Shock	490 m/s ²	

External dimensions diagram

• A5N1001

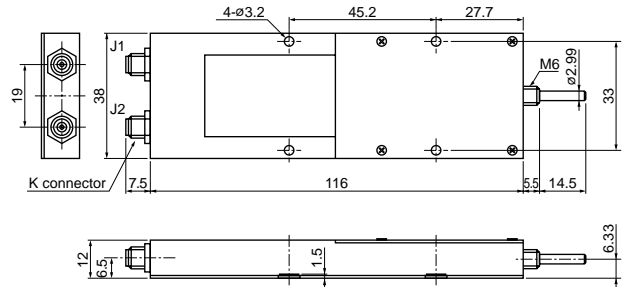

• A5N1102

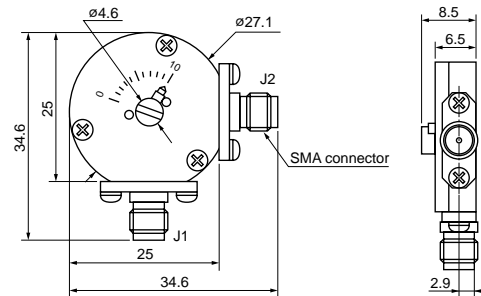

BIAS TEE

A3N1000 series

100 kHz to 20 GHz

For Supplying Bias to I/O Port

The Bias Tee is a device used for superimposing or extracting direct current component without affecting a high-frequency signal. When connected to output of an open-drain type amplifier, it can extract direct current component without any waveform deterioration.

Specifications

Model	A3N1001 to A3N1008			A3N1013 to A3N1016			A3N1017 to A3N1020			A3N1024 to A3N1027			
	Min.	Typ.	Max.	Min.	Typ.	Max.	Min.	Typ.	Max.	Min.	Typ.	Max.	
Frequency	100 kHz	–	20 GHz	100 kHz	–	20 GHz	100 kHz	–	20 GHz	8 kHz	–	20 GHz	
Insertion loss	100 kHz	–	2 dB	3 dB	–	2 dB	3 dB	–	2 dB	3 dB	–	2 dB (8 kHz)	3 dB (8 kHz)
	200 kHz	–	0.5 dB	–	–	0.5 dB	–	–	0.5 dB	–	–	–	–
	1 GHz	–	0.2 dB	–	–	0.2 dB	–	–	0.5 dB	–	–	0.5 dB	–
	10 GHz	–	1 dB	–	–	1 dB	–	–	1 dB	–	–	1 dB	–
	20 GHz	–	2 dB	3 dB	–	2 dB	3 dB	–	2 dB	3 dB	–	2 dB	3 dB
Return loss	12 dB	20 dB	–	12 dB	20 dB	–	11 dB	20 dB	–	10 dB	20 dB	–	
Tr/Tf*1	–	18 ps	20 ps	–	18 ps	–	–	18 ps	–	–	18 ps	–	
Connector	K			K			K			K			
Remarks	Standard type			Thin type (max. 9.5 mm)			Dual type			Wide band type			

*1: $Tr/Tf = (Tm^2 - Ts^2 - Ti^2)^{1/2}$

Tm: value measured with oscilloscope, Ts: Tr/Tf of oscilloscope, Ti: Tr/Tf of signal source

Absolute maximum rating

Max. bias voltage	±30 Vdc
Max. bias current	0.5 A*1, 0.2 A*2
Operating temperature	0° to 60°C

*1: A3N1001 to A3N1020, *2: A3N1024 to A3N1027

Connectors

Model	IN/OUT connector	OUT/IN connector	Bias connector
A3N1001	K (M)	K (F)	Pin-type
A3N1002	K (F)	K (M)	
A3N1003	K (F)	K (F)	
A3N1004	K (M)	K (M)	
A3N1005	K (M)	K (F)	SMA (F)
A3N1006	K (F)	K (M)	
A3N1007	K (F)	K (F)	
A3N1008	K (M)	K (M)	
A3N1013	K (M)	K (F)	Pin-type
A3N1014	K (F)	K (M)	
A3N1015	K (F)	K (F)	
A3N1016	K (M)	K (M)	
A3N1017	K (M)	K (F)	
A3N1018	K (F)	K (M)	
A3N1019	K (F)	K (F)	
A3N1020	K (M)	K (M)	
A3N1024	K (M)	K (F)	
A3N1025	K (F)	K (M)	
A3N1026	K (F)	K (F)	
A3N1027	K (M)	K (M)	

Circuit diagram

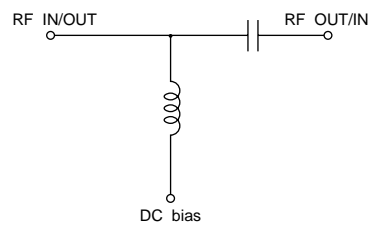



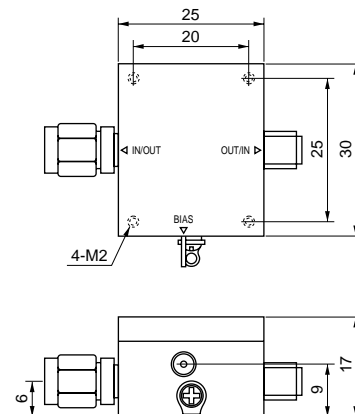







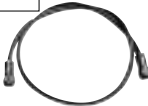

















External dimensions diagram (A3N1001)



(Unit: mm)

COAXIAL CORDS, ADAPTERS

	Impedance	Figure No.	Name			Order No.
			Item	Composition (connector · cable · connector)	Length	
Connecting cords	50 Ω	1	Coaxial cord	N-P · 5D-2W · N-P	1 m 2 m	J0576B J0576D
		30	Coaxial cord	S-5DWP · 5D-2W · S-5DWP	1 m 2 m	J0025A J0025C
		2	Coaxial cord	3CA-P2 · TG-58A/U · 3CA-P2	1 m 2 m	J0133A J0133C
		3	Clip conversion pad	N-J · Clip		J0047
		4	Coaxial cord	3CA-P2 · TG-58A/U · Alligator clip	1 m	J0054A
	75 Ω	5	Coaxial cord	3CV-P2 · 3C-2V · 3CV-P2	1 m 2 m	J0026A J0081
		6	Coaxial cord	SP-3CP · 3C-2WS · SP-3CP	1 m 2 m	J0028A J0028B
		7	Coaxial cord	SP-3CP · 3C-2WS · 3CW-P	1 m 2 m	J0029A J0029B
		8	Coaxial cord	P-5CP · 5C-2W · P-5CP	1 m 2 m	J0030A J0030B
		9	Coaxial cord	M-P-3 · 3C-2V · 3CV-P2	1 m 2 m	J0027A J0027B
		10	Coaxial cord	M-P-5 · 5C-2V · M-P-5	1 m 2 m	J0031A J0031B
	(balanced)	11	Balanced cord	I-214APS · C1UUS shielded connecting cord · I-214APS	1 m 2 m	J0032 J0033
		12	Balanced cord	M-214S · Shielded connecting cord · M-214S	1 m	J0050A
13		CS1-MM2 shielded connecting cord		2 m	J0034	
Conversion connectors	50 Ω	14	Coaxial adapter	N-P · N-P	–	J0038
		15	Coaxial adapter	N-J · N-J	–	J0039
		16	Coaxial adapter	N-P · BNC-J	–	J0040
		17	Coaxial adapter	N-J · BNC-J	–	J0044
		18	Coaxial adapter	N-J · BNC-P	–	J0043
	–	19	Coaxial adapter	N-P · M-J		J0041
		20	Coaxial adapter	N-J · M-P	–	J0042
	75 Ω	21	Coaxial adapter	NC-P · SP-3CJ	–	J0046
		22	Coaxial adapter	NC-P · BNC-J	–	J0055
		23	Coaxial adapter	BNC-P · M-J	–	J0045
24		Coaxial adapter	SP-3CJ · 3C-P (BNC-P)	–	J0053	
25		Coaxial adapter	SP-3CP · 3C-J (BNC-J)	–	J0052	
U-link	75 Ω	26	MP529A U-Link		–	
Coaxial T-connectors	50 Ω	27	Coaxial T-connector	S (N)-type	–	J0048
	70 Ω	28	Coaxial T-connector	M-type	–	J0049

Order Number	J0576B/D	1	J0133A/C	2	J0047	3	
Item/Composition		Coaxial cord 1 m/2 m N-P · 5D-2W · N-P		Coaxial cord 1 m/2 m 3CA-P2 · RG-58A/U · 3CA-P2		Clip conversion pad, N-J · clip	
J0054A	4	J0026A J0081	5	J0028A/B	6	J0029A/B	7
	Coaxial cord 1 m 3CA-P2 · RG-58A/U · Alligator clip		Coaxial cord 1 m/2 m 3CV-P2 · 3C-2V · 3CV-P2		Coaxial cord 1 m/2 m SP-3CP · 3C-2WS · SP-3CP		Coaxial cord 1 m/2 m SP-3CP · 3C-2WS · 3CW-P
J0030A/B	8	J0027A/B	9	J0031A/B	10	J0032 J0033	11
	Coaxial cord 1 m/2 m P-5CP · 5C-2W · P-5CP		Coaxial cord 1 m/2 m M-P-3 · 3C-2V · 3CV-P2		Coaxial cord 1 m/2 m M-P-5 · 5C-2V · M-P-5		Balanced cord 1 m/2 m I-214APS · C1UUS shielded connecting cord · I-214APS
J0050A	12	J0034	13	J0038	14	J0039	15
	Balanced cord 1 m, M-214S · shielded connecting cord · M-214S (compatible with I-214APS)		CS1-MM2 shielded connecting cord, 2 m		Coaxial adapter N-P · N-P		Coaxial adapter N-J · N-J
J0040	16	J0044	17	J0043	18	J0041	19
	Coaxial adapter N-P · BNC-P		Coaxial adapter N-J · BNC-J		Coaxial adapter N-J · BNC-P		Coaxial adapter N-P · M-J
J0042	20	J0046	21	J0055	22	J0045	23
	Coaxial adapter N-J · M-P		Coaxial adapter NC-P · SP-3CJ		Coaxial adapter NC-P · BNC-J		Coaxial adapter BNC-P · M-J
J0053	24	J0052	25	-	26	J0048	27
	Coaxial adapter SP-3CJ · 3C-P (BNC-P)		Coaxial adapter SP-3CP · 3C-J (BNC-J)		MP529A U-Link		Coaxial T-connector, 50 Ω, S (N) type
J0049	28	J0025A/C	29				
	Coaxial T-connector, 75 Ω, M type		Coaxial cord 1 m/2 m S-5DWP · 5D-2W · S-5DWP				

List of principal coaxial cables

Coaxial cable	Characteristic impedance	Nominal attenuation (10 MHz)	Nominal capacitance	Finished diameter	Mass (g/m)	Suitable connector	Remarks
3C-2V	75 ±3 Ω (10 MHz)	0.042 dB/m	67 pF/m	5.8 mm	48	3C connector	Single outer conductor, PVC covered
3C-2W				6.5 mm	75		Double outer conductor, PVC covered
3C-2Z				3.8 mm	28	3C connector	Single outer conductor, No PVC covered
3C-2T				7.4 mm	110		Triple outer conductor, PVC covered
3C-2WS	75 ±1 Ω (10 MHz)	0.048 dB/m		6.6 mm	76	SP connector	Double outer conductor, PVC covered
5C-2V	75 ±3 Ω (10 MHz)	0.027 dB/m	100 pF/m	7.8 mm	75	5A connector plug for 1 V type, connector for 1 V type	Single outer conductor, PVC covered
5C-2W				8.5 mm	110		Double outer conductor, PVC covered
5C-2Z				5.8 mm	48		Single outer conductor, No PVC covered
3D-2W				6.4 mm	75		Double outer conductor, PVC covered
5D-2V	50 ±2 Ω (10 MHz)	0.047 dB/m	100 pF/m	7.5 mm	85	S connector	Single outer conductor, PVC covered
5D-2W		0.031 dB/m		8.2 mm	120		Double outer conductor, PVC covered
RG-55/U	53.5 ±2.5 Ω (4 MHz)	0.0328 dBm	93.5 pF/m	5.25 mm	55	BNC	Double outer conductor, PE covered
RG-58/U				4.95 mm	50	BNC, N	Single outer conductor, PVC covered
RG-58A/U				50 ±2 Ω (10 MHz)	0.0427 dB/m		

Dimensions of waveguide flanges

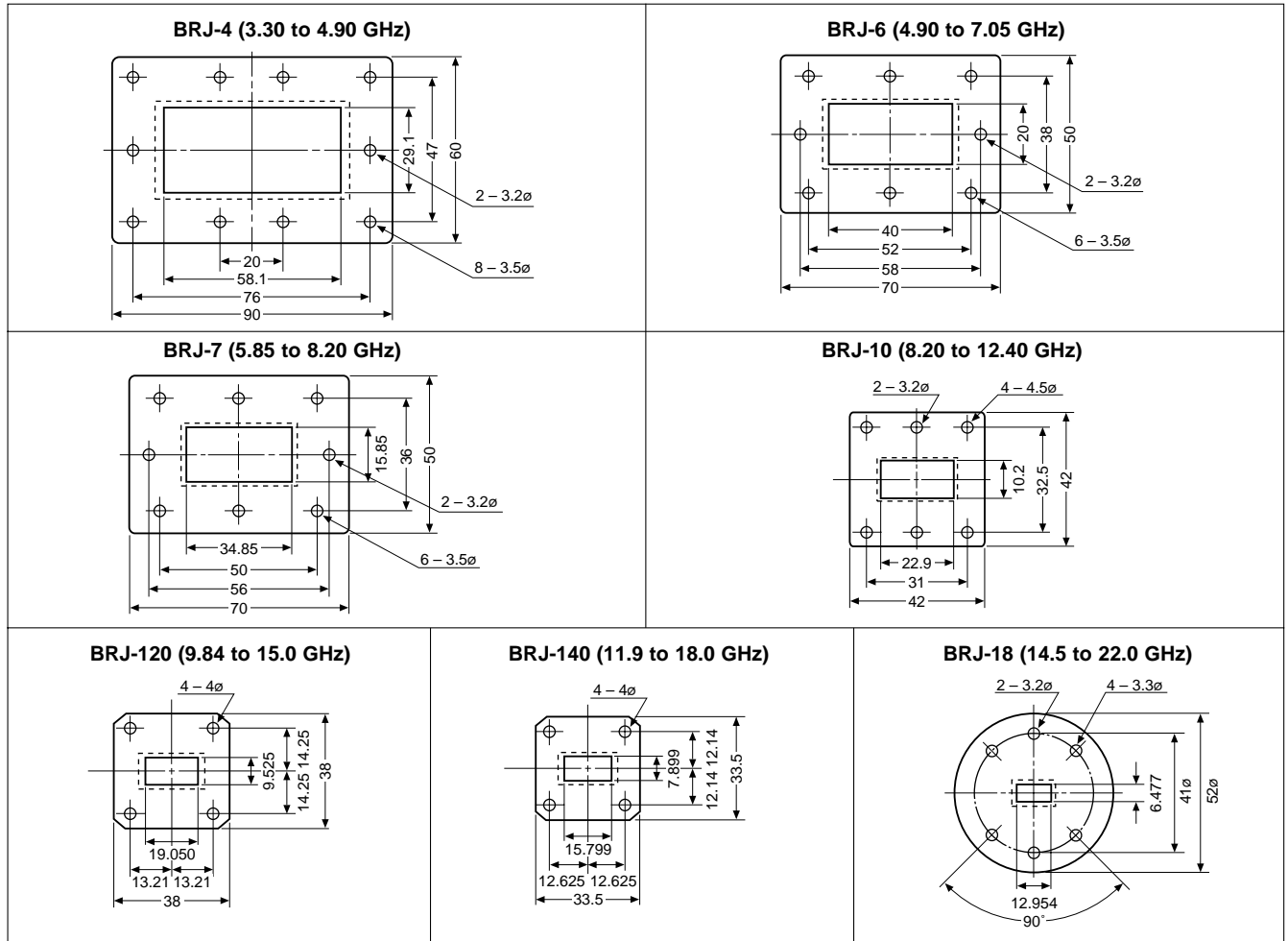

(Unit: mm)

ACCESSORIES FOR F-SERIES CABINETS

Anritsu's F-series cabinet was designed using basic dimensions that conform to EIA and IEC racking specifications, permitting compatible equipment to be easily stacked up to form a system, or to be mounted on the EIA/IEC standard rack.

The accessories of the F-series cabinet are easy to mount and use, and blend with the design of the cabinet. The F-series can be identified by its green feet.

- **Protective cover**
Protects front of cabinet

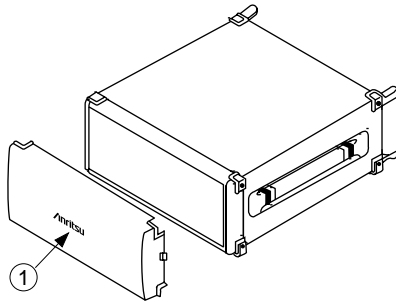

No.	Description	Quantity
①	Protective cover	1

Item	Order No.
Protective cover 1MW2U	B0329A
Protective cover 1MW3U	B0329B
Protective cover 1MW4U	B0329C
Protective cover 1MW5U	B0329D
Protective cover 3/4MW3U	B0329F
Protective cover 3/4MW4U	B0329G
Protective cover 2/3MW4U	B0329K
Protective cover 1/2MW2U	B0329L

- **Coupler**
To mount two or more F-series cabinet in a stack

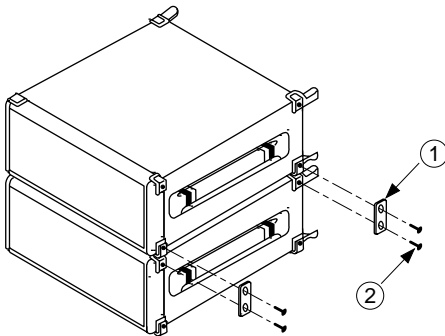

No.	Description	Quantity
①	Coupler	4
②	Screw	8

Item	Order No.
Coupler	B0332

- **Tilt stand**
Allows cabinet to be used at an angle

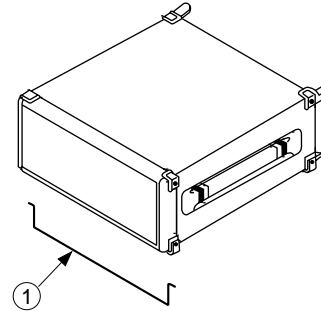

No.	Description	Quantity
①	-	1

Item	Order No.
Tilt stand 1MW450D	B0330A
Tilt stand 3/4MW450D	B0330B
Tilt stand 3/4MW350D	B0330C
Tilt stand 2/3MW350D	B0330D

- **Rack mount kit**
The rack mount accessory is for use with 1MW450D cabinet. For EIA/IEC standard rack

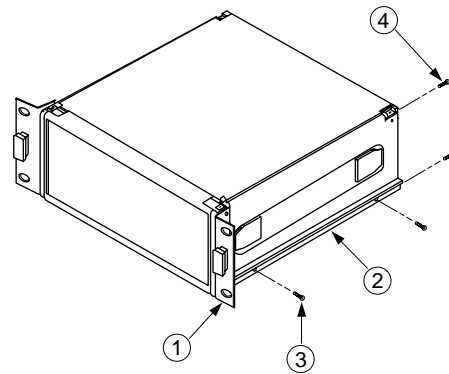

No.	Description	Quantity
①	Rack flange	2
②	Side rail	2
③	5NPS25S7 + SW	2
④	4NPS6S7 + SW	4

Item	Order No.
Rack mount kit 2U	B0333A
Rack mount kit 3U	B0333B
Rack mount kit 4U	B0333C
Rack mount kit 5U	B0333D

• F-series cabinet rack mount dimensions

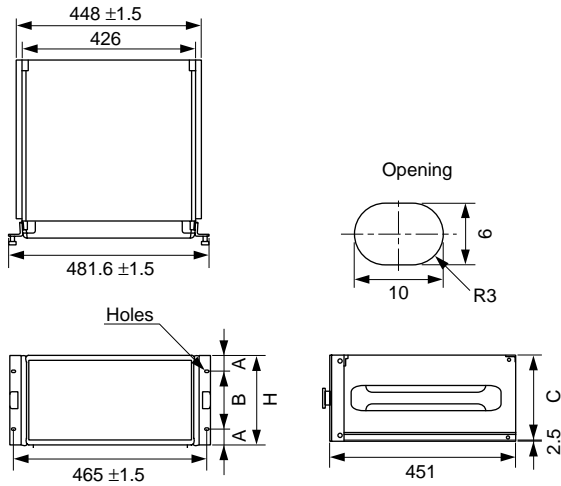

Unit: mm

Cabinet height	H	A	B	C
2U	88	5.9	76.2	85.5
3U	132.5	37.7	57.1	130
4U	177	37.7	101.6	174.5
5U	221.5	37.7	146.1	219

• Cabinet angle support dimensions

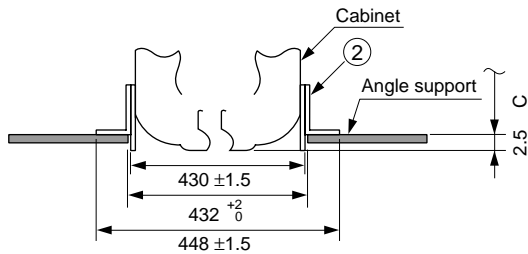

Note: Merely attaching the equipment to the rack with rack mount kit does not provide enough support. Use either angle supports or shelves to provide the necessary support.

• Front handle

Protects the front section

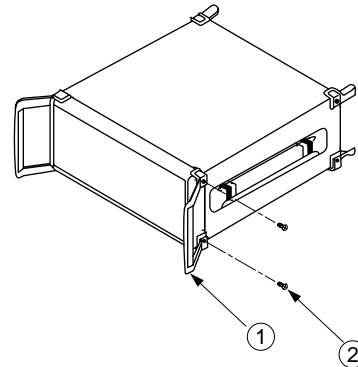

No.	Description	Quantity
①	Front handle	2
②	Screw	4

Item	Order No.
Front handle 2U	B0331A
Front handle 3U	B0331B
Front handle 4U	B0331C
Front handle 5U	B0331D

• Symbol and dimensions of F-series cabinet

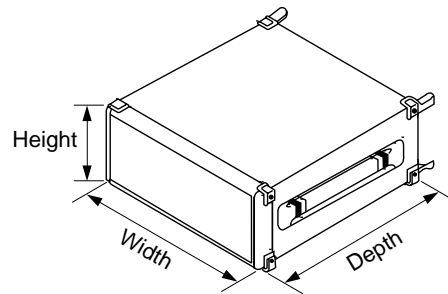

Height

Symbol	Dimension (mm)
2U	88
3U	132.5
4U	177
5U	221.5
6U	266

Width

Symbol	Dimension (mm)
1MW	426
3/4MW	320
2/3MW	284
1/2MW	213

Depth

Symbol	Dimension (mm)
250D	251
350D	351
450D	451

Note: knobs, handles, and feet are not included in cabinet external dimensions.

ACCESSORIES FOR E-SERIES CABINETS

Anritsu's E-series cabinet was designed using basic dimensions that conform to EIA and IEC racking specifications, permitting compatible equipment to be easily stacked up to form a system, or to be mounted on the EIA/IEC standard rack. Featuring a balanced design, the E-series cabinet accessories provide ease of mounting and use. The E-series cabinet can be identified by the four silver metal sections between its top and side surfaces.

• Front/rear cover

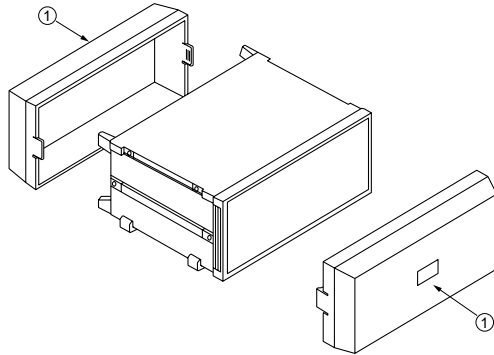

Protects front and back of cabinet. Due to projections, the rear cover may not be usable with some equipment. Front handles and front cover cannot be used simultaneously.

No.	Description	Quantity
①	Front/rear cover	1

Item	Order No.
Front/rear cover 1MW2U	B0018
Front/rear cover 1MW3U	B0019
Front/rear cover 1MW4U	B0020
Front/rear cover 1MW5U	B0021
Front/rear cover 1MW6U	B0022
Front/rear cover 2/3MW2U	B0023
Front/rear cover 2/3MW3U	B0024
Front/rear cover 2/3MW4U	B0025
Front/rear cover 1/2MW2U	B0026
Front/rear cover 1/2MW3U	B0027

• Front handle kit

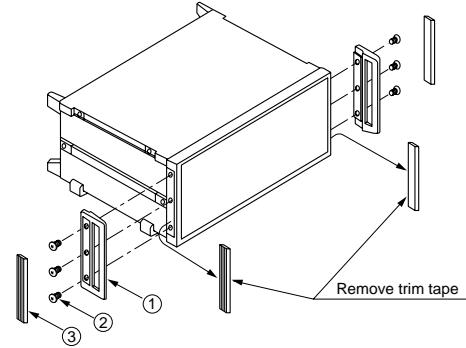

Front cover cannot be used.

No.	Description	Quantity	
①	Front handle	2	
②	Screw	2U to 3U*1	4
		4U to 6U	6
③	Trim tape	2	

*1: Denotes height of cabinet

Item	Order No.
Front handle kit 2U	B0036
Front handle kit 3U	B0037
Front handle kit 4U	B0038
Front handle kit 5U	B0039
Front handle kit 6U	B0040

• Stacking foot

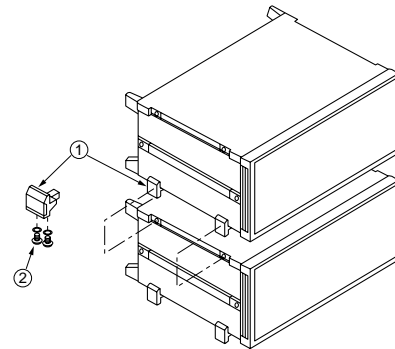

These one-touch lock feet replace the standard molded feet for use when stacking equipment of the same width and depth, and when mounting the equipment on a portable test rack.

No.	Description	Quantity
①	Stacking foot	4
②	Screw	8

Item	Order No.
Stacking feet	B0029

Note: By replacing the standard molded feet with stacking feet (B0029), the 1MW cabinet can be used with Anritsu's portable test racks MB23A and MB24B.

• Rack flange kit

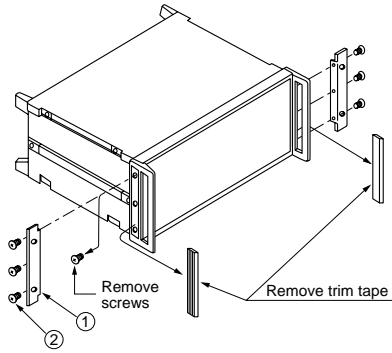

The rack mount accessory is for use with equipment having 1MW cabinet width providing front handles.

No.	Description	Quantity	
①	Rack flange	2	
②	Screw	2U to 3U	4
		4U to 6U	6

Item	Order No.
Rack flange kit 2U	B0046
Rack flange kit 3U	B0047
Rack flange kit 4U	B0048
Rack flange kit 5U	B0049
Rack flange kit 6U	B0050

Note: • For 1MW cabinets
 • When assembled, the panel width is suitable for 19-inch racks.
 • For EIA/IEC standard rack

• Rack mount kit

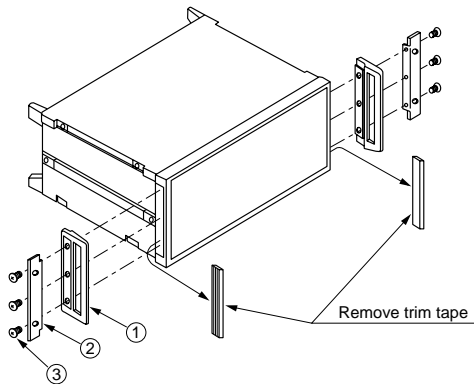

The rack mount accessory is for use with equipment having 1MW cabinet width.

Note: Merely attaching the equipment to the rack with rack mount kit does not provide enough support. Use either angle supports or shelves to provide the necessary support.

No.	Description	Quantity	
①	Front handle	2	
②	Rack flange	2	
③	Screw	2U to 3U	4
		4U to 6U	6

Item	Order No.
Rack mount kit 2U	B0041
Rack mount kit 3U	B0042
Rack mount kit 4U	B0043
Rack mount kit 5U	B0044
Rack mount kit 6U	B0045

Note: • For 1MW cabinets
 • When assembled, the panel width is suitable for 19-inch racks.
 • For EIA/IEC standard rack

• E-series cabinet rack mount dimensions

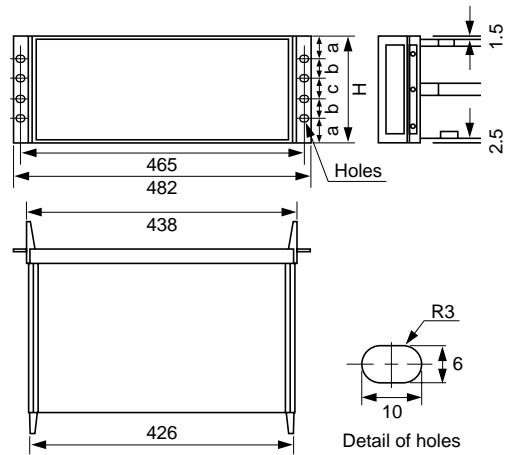

Cabinet height	H (mm)	a	b	c
2U	88	5.9	–	76.2
3U	132.5	37.7	–	57.1
4U	177	37.7	–	101.6
5U	221.5	37.7	–	146.1
6U	266	37.7	57.1	76.2

Note: This space provides room to attach a flange for supporting the equipment

• Symbol and dimensions of E-series cabinet

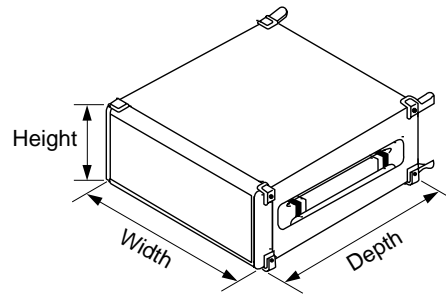

Height

Symbol	Dimension (mm)
2U	88
3U	132.5
4U	177
5U	221.5
6U	266

Width

Symbol	Dimension (mm)
1MW	426
3/4MW	320
2/3MW	284
1/2MW	213

Depth

Symbol	Dimension (mm)
250D	251
350D	351
450D	451

Note: knobs, handles, and feet are not included in cabinet external dimensions.

Quality and Reliability Assurance System

ISO9000/14000

Measurement solutions products contained in this catalogue are manufactured under a quality system and environment management system in conformance to the ISO international standard.

Factory name	Conformed standard	Qualification number	Qualified date	Qualification organization
Atsugi factory	ISO9001	JQA-0316	Nov. 15, 1993	Japan Quality Assurance Organization (JQA)
	ISO14001	JQA-EM0210	Aug. 28, 1998	
Tohoku Anritsu	ISO9002	JQA-0737	Dec. 28, 1994	
	ISO14001	JQA-EM0560	Oct. 22, 1999	
England factory	ISO9001	FS22679	May 24, 1999	BSI Quality Assurance
	ISO14001	EMS54120	Mar. 15, 2000	
U.S.A factory	ISO9001	6495	Apr. 17, 2001	The Seal of National Quality Assurance Limited

Quality and Reliability Assurance for Products

• Planning stage

Management resources are focused on measuring instruments related to growing fields such as mobile Internet, WDM and digital broadcasting, ATE and device businesses. New products are planned to provide solutions whenever required by users.

• Design stage

To realize a design with high-safety and high-reliability, several levels of design assessments are performed. Power consumption is reduced from the viewpoint of product assessment, starting with evaluation of specifications, legal regulations and used parts. Evaluations are also implemented for improving the recycling ratio and so forth, and the design quality is improved.

Anritsu engages a design that targets customer satisfaction.

• Evaluation stage

In addition to safety, reliability and environment considerations of test models for the new product, functions and performance are verified by an environment test and operability, uncertainty, maintainability and flexibility of design are evaluated fully. After passing these tests, the products can be commercialized.

• Manufacturing and inspection stages

Based on our policy, "post-processing is the customer", the product is manufactured by experienced employees according to the work standards. In the adjustment and inspection stage, automatic measurement is promoted. An expert will be in charge of the adjustment if high-skilled adjustment is required.

• After sold

In each service department, traceability assurance by calibrations based on high-technical capabilities, as well as rapid repair and preventive maintenance are performed.

Parts standardization and improving activities for quality and reliability

For parts generally used in each measuring instrument, quality improvement and standardization are actively promoted. All field data are analyzed, arranged and completely made known to each department while required actions are taken for reliability improvement. In addition, failure rate, MTBF observation and parts failure rate are calculated based on this information.

Traceability assurance

As defined in the International Vocabulary of Basic and General Terms in Metrology (VIM; 1993), traceability is defined as "the property of the result of a measurement or the value of a standard whereby it can be related to stated references, usually national or international standards, through an unbroken chain of comparisons all having stated uncertainties." Anritsu's system to ensure traceability is shown below. Measurements made by Anritsu's laboratory's are traceable to national, international, or intrinsic standards, where such standards are available.

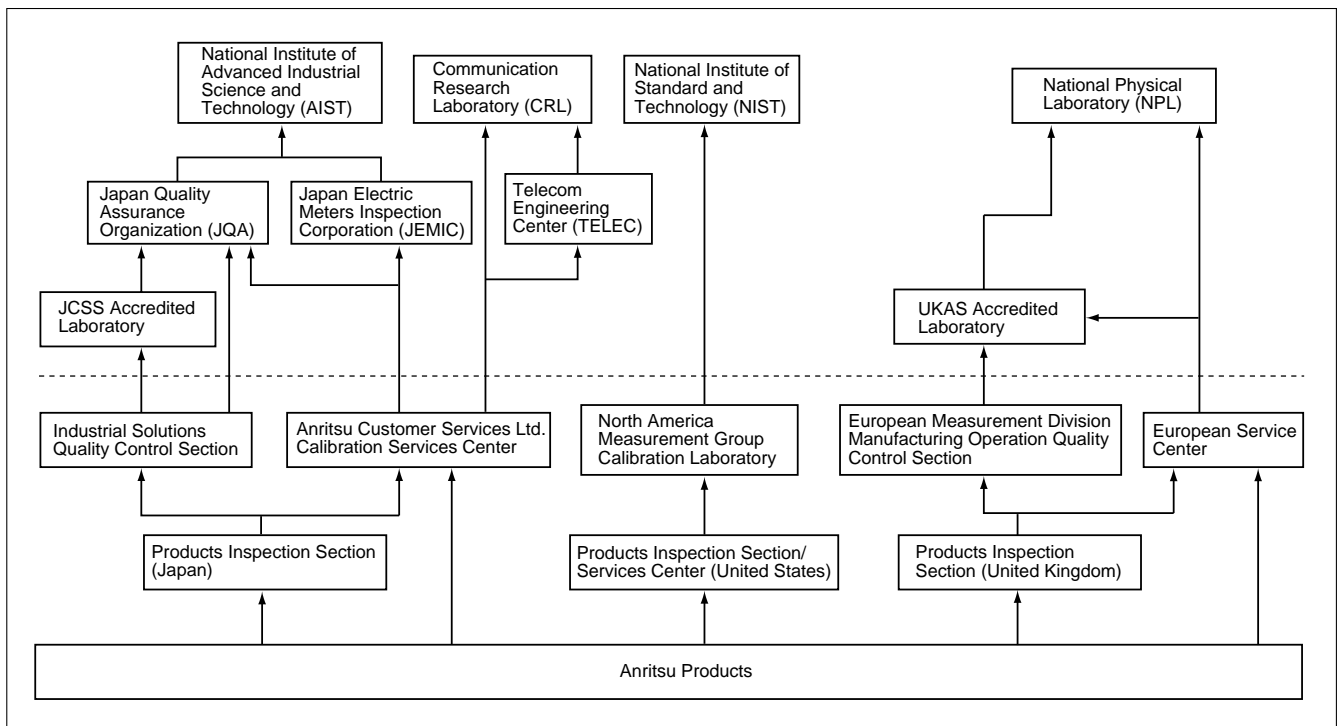

Архангельск (8182)63-90-72
Астана (7172)727-132
Астрахань (8512)99-46-04
Барнаул (3852)73-04-60
Белгород (4722)40-23-64
Брянск (4832)59-03-52
Владивосток (423)249-28-31
Волгоград (844)278-03-48
Вологда (8172)26-41-59
Воронеж (473)204-51-73
Екатеринбург (343)384-55-89
Иваново (4932)77-34-06

Ижевск (3412)26-03-58
Иркутск (395)279-98-46
Казань (843)206-01-48
Калининград (4012)72-03-81
Калуга (4842)92-23-67
Кемерово (3842)65-04-62
Киров (8332)68-02-04
Краснодар (861)203-40-90
Красноярск (391)204-63-61
Курск (4712)77-13-04
Липецк (4742)52-20-81

Магнитогорск (3519)55-03-13
Москва (495)268-04-70
Мурманск (8152)59-64-93
Набережные Челны (8552)20-53-41
Нижний Новгород (831)429-08-12
Новокузнецк (3843)20-46-81
Новосибирск (383)227-86-73
Омск (3812)21-46-40
Орел (4862)44-53-42
Оренбург (3532)37-68-04
Пенза (8412)22-31-16

Пермь (342)205-81-47
Ростов-на-Дону (863)308-18-15
Рязань (4912)46-61-64
Самара (846)206-03-16
Санкт-Петербург (812)309-46-40
Саратов (845)249-38-78
Севастополь (8692)22-31-93
Симферополь (3652)67-13-56
Смоленск (4812)29-41-54
Сочи (862)225-72-31
Ставрополь (8652)20-65-13

Сургут (3462)77-98-35
Тверь (4822)63-31-35
Томск (3822)98-41-53
Тула (4872)74-02-29
Тюмень (3452)66-21-18
Ульяновск (8422)24-23-59
Уфа (347)229-48-12
Хабаровск (4212)92-98-04
Челябинск (351)202-03-61
Череповец (8202)49-02-64
Ярославль (4852)69-52-93

Киргизия (996)312-96-26-47

Россия (495)268-04-70

Казахстан (772)734-952-31

<https://anritsu.nt-rt.ru/> || aus@nt-rt.ru